



Defender[®] 5000 Indicators Instruction Manual



TD52XW



TD52P

TABLE OF CONTENTS

1. INTRODUCTION	5
1.1 Safety Precautions	5
1.1.1 Relay Option Safety Precautions	5
1.2 Overview of Parts and Controls	6
1.3 Control Functions.....	9
2. INSTALLATION	10
2.1 Unpacking	10
2.2 External Connections.....	10
2.2.1 Scale Base with Connector.....	10
2.2.2 RS232 interface Cable to TD52P	10
2.2.3 AC Power to TD52P	10
2.2.4 AC Power to TD52XW.....	10
2.2.5 Battery Power.....	10
2.3 Internal Connections.....	11
2.3.1 Opening the Housing	11
2.3.2 Scale Base Without Connector	11
2.3.3 RS232 Interface Cable to TD52XW	13
2.3.4 MICRO SD Card Installation.....	14
2.4 TD52XW Rear Housing Orientation	14
2.5 Mounting Bracket	14
3. SETTINGS	15
3.1 Menu Structure	15
3.2 Menu Navigation.....	18
3.3 Calibration Menu	18
3.3.1 Zero Calibration	18
3.3.2 Span Calibration	19
3.3.3 Linearity Calibration	20
3.3.4 GEO Adjustment	21
3.4 Setup Menu	22
3.4.1 Capacity Unit.....	22
3.4.2 Range	22
3.4.3 Capacity	22
3.4.4 Graduation.....	23
3.4.5 Language	23
3.4.6 Power On Zero	23
3.4.7 Power On Unit	23
3.4.8 Key Beep.....	23

3.4.9 Transaction Counter	24
3.4.10 I/O Type	24
3.4.11 Reset	24
3.5 Readout Menu	24
3.5.1 Stability	24
3.5.2 Zero Range	24
3.5.3 Filter Level	25
3.5.4 Auto Zero Tracking	25
3.5.5 Auto Dim	25
3.5.6 ScreenSaver	25
3.5.7 Auto Off	25
3.5.8 Adjust Contrast	25
3.5.9 Reset	25
3.6 Discrete I/O	26
3.7 Weighing Unit	28
3.7.1 Gram (g)	28
3.7.2 Kilogram (kg)	28
3.7.3 Pound (lb)	28
3.7.4 Ounce (oz)	28
3.7.5 Pound: Ounce (lb: oz)	28
3.7.6 Tonne (Metric Tonne)	28
3.7.7 Ton (Short Ton)	28
3.7.8 Custom Unit (c)	28
3.8 GLP/GMP Menu	29
3.8.1 Date Format	29
3.8.2 Date	29
3.8.3 Time Format	29
3.8.4 Time	29
3.8.5 Project ID	29
3.8.6 Scale ID	29
3.8.6 Reset	30
3.9 Communication	30
3.9.1 RS232/2nd RS232 Configuration	30
3.9.2 Print Setup of RS232/2nd RS232	31
3.9.3 RS485 Configuration	34
3.9.4 Ethernet Configuration	34
3.9.5 Wifi Configuration	34
3.9.6 Bluetooth Configuration	34

3.9.7 Analog Configuration	34
3.10 Maintenance Configuration	34
3.11 Lock Key Configuration	34
4. OPERATION	35
4.1 Weighing	35
4.1.1 Application Setup	35
4.1.2 Auto Tare	35
4.1.3 Accumulation	36
4.1.4 ID Input	37
4.1.5 Input/Output (I/O) Setup	37
4.2 Counting	38
4.2.1 Set the Average Piece Weight (APW)	38
4.2.2 Application Setup	39
4.2.3 Accumulation	40
4.2.4 Input/Output (I/O) Setup	40
4.3 Check	41
4.3.1 Check Weighing (default)	41
4.3.2 Check Counting	42
4.3.3 Application Setup	43
4.3.4 Input/Output (I/O) Setup	44
4.4 Percent Weighing	44
4.4.1 Establishing a Reference Weight	45
4.4.2 Application Setup	45
4.4.3 Input/Output (I/O) Setup	46
4.5 Dynamic Weighing	47
4.5.1 Application Setup	47
4.5.2 Average Time Setup	49
4.5.3 Input/Output (I/O) Setup	50
4.5 Filling	51
4.5.1 Establishing target weights	51
4.5.2 Application Setup	51
4.5.3 Input/Output (I/O) Setup	52
5. SERIAL COMMUNICATION	54
5.1 Interface Command	54
5.2 RS232 Interface	54
5.3 Connecting to a Computer	55
5.4 Connecting to a Serial Printer	55
5.5 Printouts	55

5.6 Printout Examples	56
6. MICRO SD CARD/USB	57
6.1 Library	57
6.2 User	60
6.3 Alibi	63
6.4 Editable	64
7. LEGAL FOR TRADE	65
7.1 Settings	65
7.2 Verification	65
7.3 Sealing	65
8. MAINTENANCE.....	66
8.1 Model T52P Cleaning	66
8.2 Model TD52XW Cleaning	66
8.3 Troubleshooting	66
8.4 Service Information	67
9. TECHNICAL DATA	67
9.1 Specifications	67
9.2 Accessories and Options	69
9.3 Drawings and Dimensions	70
9.4 Table of Geo Values	71
10. COMPLIANCE	72
11. APPENDICES.....	74
11.1 Appendix A	74
11.2 Appendix B	76

1. INTRODUCTION

This manual contains installation, operation and maintenance instructions for the TD52P and TD52XW Indicators. Please read this manual completely before installation and operation.

1.1 Safety Precautions



For safe and dependable operation of this equipment, please comply with the following safety precautions:

- Verify that the input voltage range printed on the data label matches the local AC power to be used.
- Make sure that the power cord does not pose a potential obstacle or tripping hazard.
- Use only approved accessories and peripherals.
- Operate the equipment only under ambient conditions specified in these instructions.
- Disconnect the equipment from the power supply when cleaning.
- Do not operate the equipment in hazardous or unstable environments.
- Do not immerse the equipment in water or other liquids.
- Service should only be performed by authorized personnel.
- The TD52XW is supplied with a grounded power cable. Use only with a compatible grounded power outlet.

1.1.1 Relay Option Safety Precautions

This equipment may have an optional Discrete I/O board installed. This option allows external devices to be controlled by the Indicator.



CAUTION: ELECTRICAL SHOCK HAZARD. REMOVE ALL POWER CONNECTIONS TO THE INDICATOR BEFORE SERVICING OR MAKING INTERNAL CONNECTIONS. THE HOUSING SHOULD ONLY BE OPENED BY AUTHORIZED AND QUALIFIED PERSONNEL, SUCH AS AN ELECTRICAL TECHNICIAN.

Before making connections to the Relay terminals, remove power from the system. If the system contains an optional rechargeable battery system, be sure that the **ON/CLR Off** button is used to fully turn off the system after removing the AC power plug.

More detailed installation instructions are included with the Discrete I/O kit at the time of purchase.

1.2 Overview of Parts and Controls

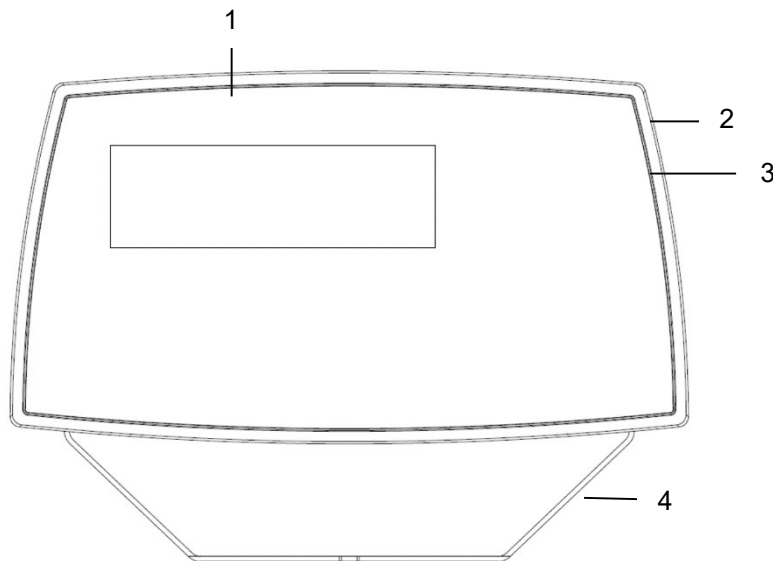

TABLE 1-1 TD52P PARTS

Item	Description
1	Data Label
2	Front Housing
3	Control Panel
4	Mounting Bracket
5	Screws (4)
6	Adjusting Knobs (2)
7	Security Screw
8	Accessory Cover
9	Rear Housing
10	Power Connector
11	RS232 Connector
12	Load Cell Connector

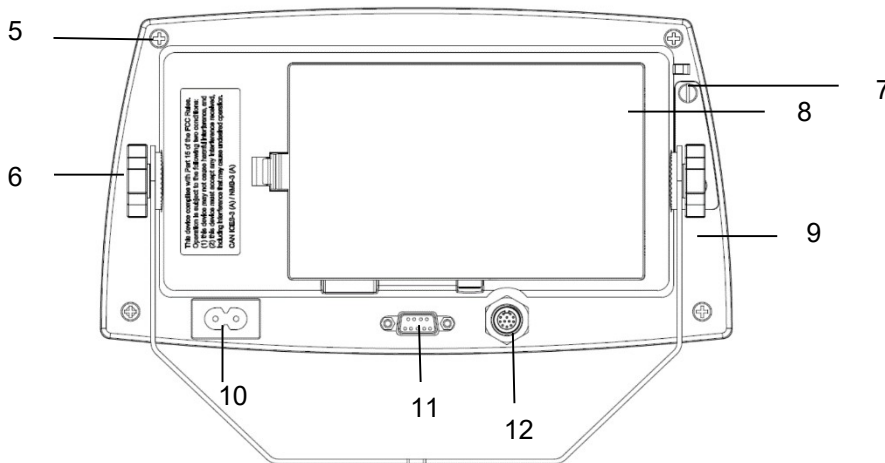

Figure 1-1 TD52P Indicator

1.2 Overview of Parts and Controls (Cont.)

TABLE 1-2 TD52XW PARTS

Item	Description
1	Control Panel
2	Front Housing
3	Screws (6)
4	Adjusting knobs (2)
5	Rear Housing
6	Mounting Bracket
7	Load Cell Connector
8	Strain Relief for Option
9	Power Cord
10	Strain Relief for Option

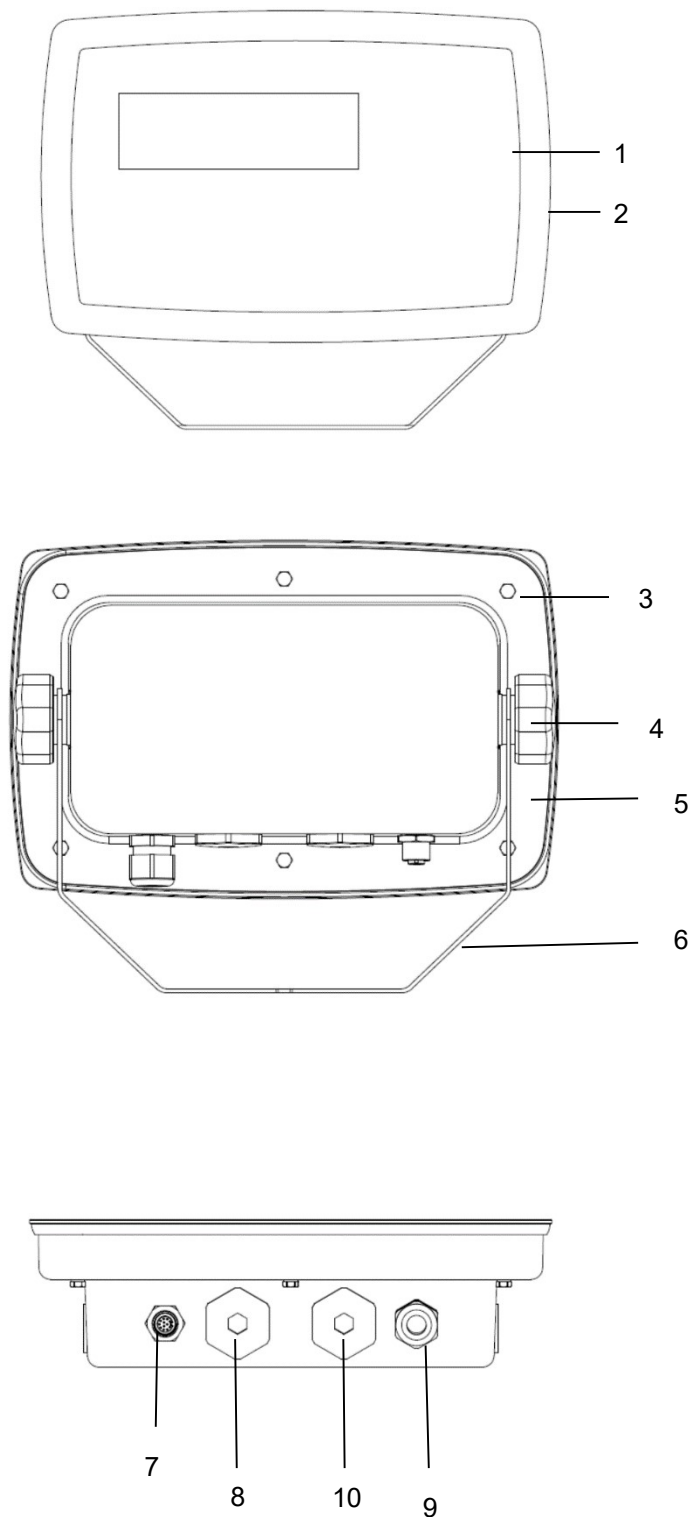

Figure 1-2 TD52XW Indicator

1.2 Overview of Parts and Controls (Cont.)

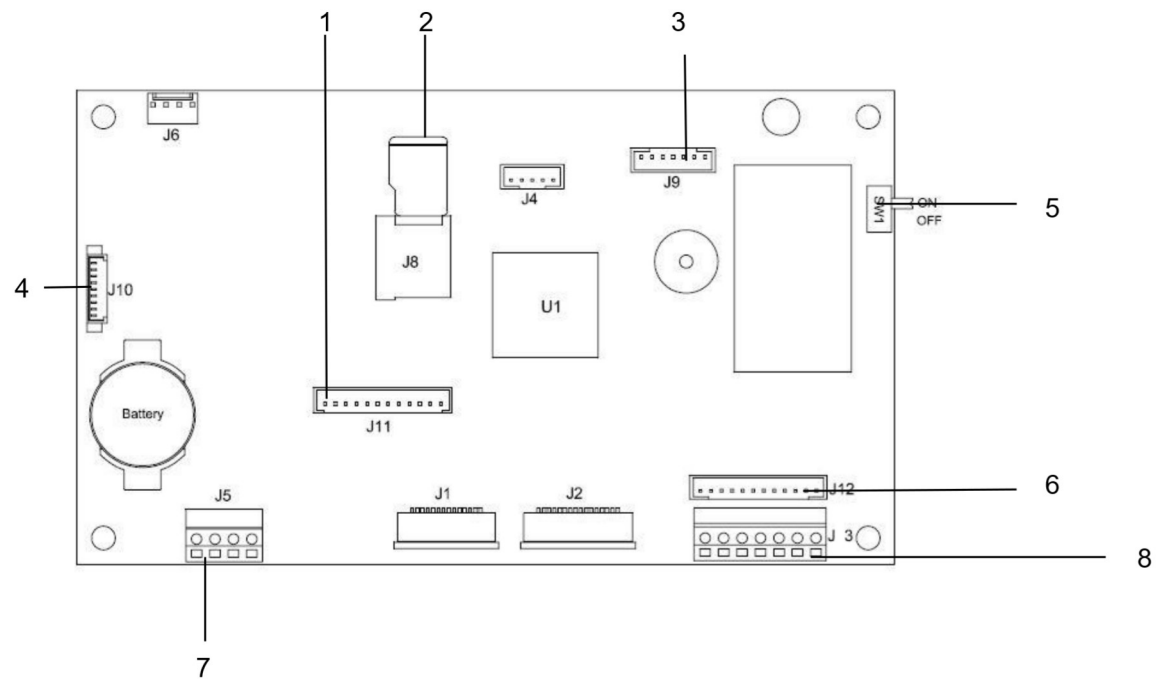
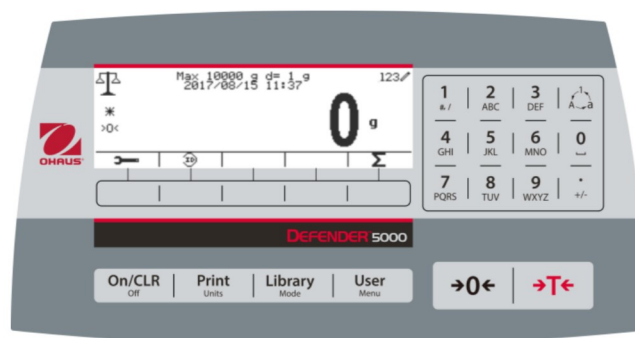

Figure 1-3 Main PC Board

TABLE 1-3 MAIN PC BOARD

Item	Description
1	IO/Analog/RS232-RS485-USB Device connector (J11)
2	Micro-SD Card slot (J8)
3	Rechargeable Battery Pack connector (J9)
4	USB Host/Ethernet connector (J4)
5	Security Switch connector (SW1)
6	Load Cell connector (J12)
7	RS232 connector (J5)
8	Load Cell Terminal Block (J3)

1.3 Control Functions



Button	Action
	Short press: If the terminal is Off, power on the terminal; if the terminal is On, clear the data input. Long press: Power off the terminal.
	Short press: Send the current display value to RS232 port or Option when properly enabled. Long press: Change the current weighing unit. Press and hold the key to scroll through the list of enabled units. Release the key to switch to the unit selected.
	Short press: Press the key to enter the Library. Long press: Press and hold this key to change weighing modes. Press and hold the key to scroll through all weighing modes. Release the key to switch to the mode selected.
	Short press: Press the key to enter user profile. Long press: Press the key to enter user menu.
	The 5 Softkeys correspond to several icons at the bottom of the display area. These icons indicate for each Softkey functions specifically available for configuration and operation of the mode.
	To enter '2'-'9', press the numeric button in the mode of numeric input. To Enter 'A', press 2 times in the mode of uppercase input. To enter 'z', press 5 times in the mode of lowercase input.
	To enter '0', press the button in the mode of numeric input. To enter a space, press the button in the mode of uppercase or lower case input.
	To enter '1', press the button in the mode of numeric input. To enter '#', or '/', press the button in the mode of uppercase input. To enter '@', '_', '&', '!', '?', '*', or '^', press the button in the mode of lowercase input.
	Switch between three input modes – numeric, lowercase and uppercase input.
	To enter '.', press the button in the mode of numeric input. To enter '+' or '-', press the button in the mode of uppercase or lowercase input.
	Short press: When the load on the pan is within the zero range, press this key to set the display to zero.
	Short press: When a container is on the pan, press this key to store the weight of the container as the tare value. Short press: Enter the known weight of a container using the numeric keypad, and then press this key to establish the preset tare value. Short press: When a tare has been entered, empty the pan and press this key to clear the tare value. Long press: If a preset tare has been entered, press this key to view the preset tare value.

2. INSTALLATION

2.1 Unpacking

Unpack the following items:

- TD52P or TD52XW Indicator
- AC Power Cord (for TD52P only)
- Mounting Bracket
- Knobs (2)
- Drilled Sealing Screws (for TD52XW only)
- Quick installation Guide
- Warranty Card
- Ferrite core

2.2 External Connections

2.2.1 Scale Base with Connector

OHAUS bases with a connector can be attached to the external load cell connector (Figure 1-1, item 12). To make the connection, plug the base connector onto the external load cell connector. Then rotate the base connector's locking ring clockwise. Refer to section 2.3.2 for bases without a connector.

2.2.2 RS232 interface Cable to TD52P

Connect the optional RS232 cable to the RS232 connector (Figure 1-1, item 11).

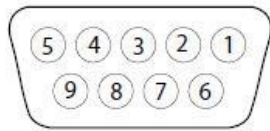

Figure 2-1 RS232 Pins

Pin	Connection
1	N/C
2	TXD
3	RXD
4	N/C
5	GND
6	N/C
7	CTS
8	RTS
9	N/C

2.2.3 AC Power to TD52P

Connect the AC power cord (supplied) to the power receptacle (Figure 1-1, item 10), then connect the AC plug to an electrical outlet.

2.2.4 AC Power to TD52XW

Connect the AC plug to a properly grounded electrical outlet.

2.2.5 Battery Power

The indicator can be operated on the rechargeable battery pack (optional) when AC power is not available. It will automatically switch to battery operation if there is power failure or the power cord is removed. The indicator can operate for up to 21 hours on battery power. During battery operation, the battery charge symbol indicates the battery status. The indicator will automatically turn-off when the batteries are fully discharged. Find detailed installation information in battery pack (P/N 30424405) operation manual.

	Battery 5 - 25 % remaining
	Battery 25 - 50 % remaining
	Battery 50 - 75 % remaining
	Battery 75 - 100 % remaining

2.3 Internal Connections

Some connections require the housing to be opened.

2.3.1 Opening the Housing



CAUTION: ELECTRICAL SHOCK HAZARD. REMOVE ALL POWER CONNECTIONS TO THE INDICATOR BEFORE SERVICING OR MAKING INTERNAL CONNECTIONS. THE HOUSING SHOULD ONLY BE OPENED BY AUTHORIZED AND QUALIFIED PERSONNEL, SUCH AS AN ELECTRICAL TECHNICIAN.

TD52P

Remove the four Phillips head screws from the rear housing.
Remove the front housing being careful not to disturb the internal connections.
Once all connections are made, reattach the front housing.

TD52XW

Remove the four hex head screws from the rear housing.
Open the housing by carefully pulling the front housing forward.
Once all connections are made, reattach the front housing.
The screws should be tightened to 2.5 N•m (20-25 in-lb) torque to ensure a watertight seal.

2.3.2 Scale Base Without Connector

For connecting bases (which do not have the Defender base quick connector) to a TD52P or TD52XW, a Load cell cable gland kit (P/N 30379716) is available as an accessory.

Removing the pre-installed Load Cell connector and wiring harness

Before doing the connections, remove the pre-installed Load Cell connector and wiring harness by following the steps below.

1. Open the housing by carefully pulling the front housing forward.
2. Unplug the white load cell connector from the main PCBA board (red circle).
3. Remove the metal terminal (Figure 1-1, item 12) connector from the rear housing. (green circle)

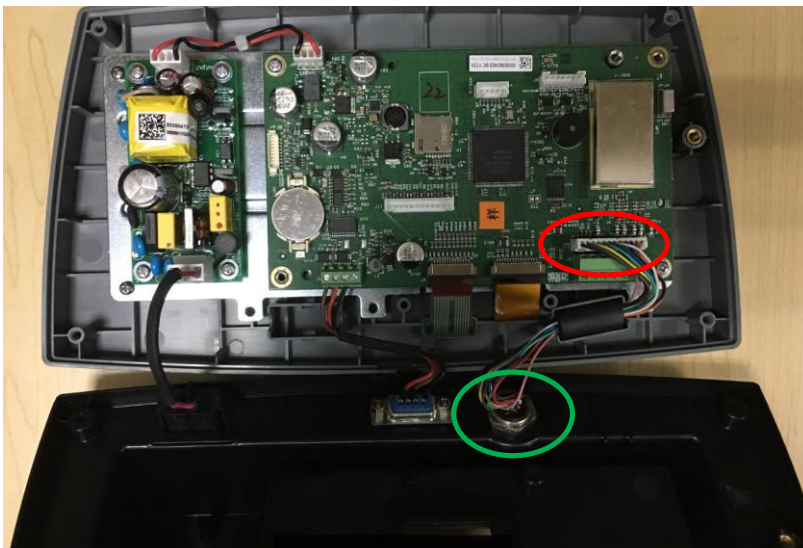

Installing Load Cell Cable and Connectors

In order to meet certain electrical noise emission limits and to protect the TD52P and TD52XW from external influences, it is necessary to install a ferrite core on the load cell cable connected to the terminal. The ferrite core is included with the terminal.

To install the ferrite, simply route the cable through the center of the core and then take one wrap around the outside of the core and route the cable through the center again. Either the complete cable or the individual wires can be wrapped through the ferrite. This should be done as close to the enclosure as possible. See Figure 2-2.



Figure 2-2

Main Board Wiring Connections

Once the TD52P and TD52XW enclosure is open, connections can be made to the terminal blocks on the main board, as shown in Figure 2-3.

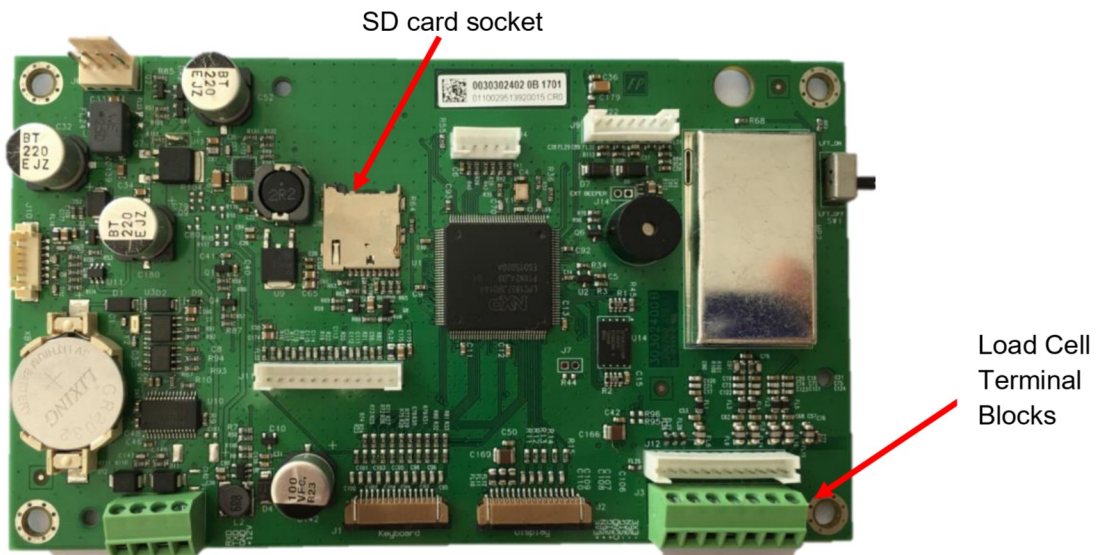
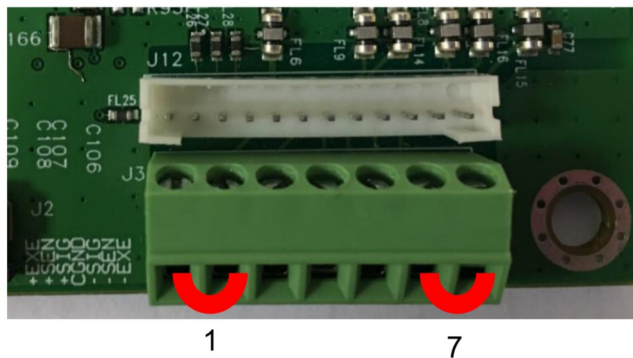

Figure 2-3

Jumper Connections

The TD52P and TD52XW indicators are designed to support both 2mV/V and 3mV/V load cells from the same circuitry. A load cell output rating selection jumper is not required.

Figure 2-4 shows the terminal definitions for the analog load cell terminal blocks. Note that when using four-wire load cells, jumpers must be placed between the +Excitation and +Sense terminals and between the Excitation and Sense terminals.



Pin	Connection
J3-1	+EXE
J3-2	+SEN
J3-3	+SIN
J3-4	GND
J3-5	-SIN
J3-6	-SEN
J3-7	-EXE

Figure 2-4 Jumper Connections

After wiring is completed, replace the indicator housing screws. Make sure the liquid-tight connector is properly tightened.



2.3.3 RS232 Interface Cable to TD52XW

Pass the optional RS232 cable through the strain relief and attach it to terminal block J5. Tighten the strain relief to maintain a watertight seal.

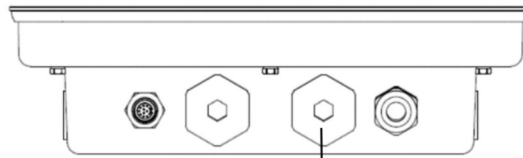

Strain Relief for Option

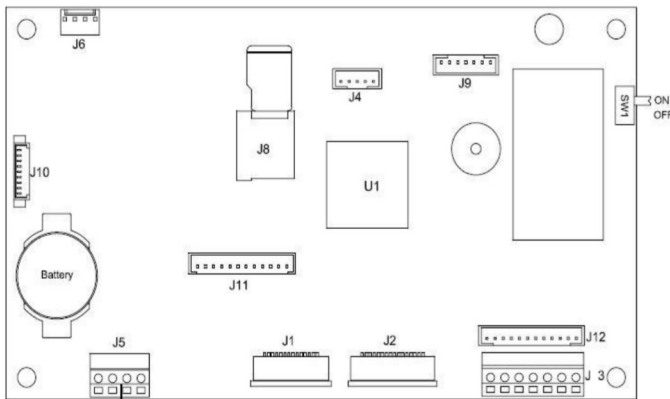

RS232 connector (J5)



2.3.4 MICRO SD Card Installation

The SD memory card can be used for additional storage in the Checkweighing and Counting applications. Figure 2-5 shows the installation of an SD card into the socket on the edge of the TD52P and TD52XW main boards.



Figure 2-5 Sliding an SD Card into the SD Socket (left); SD Card Installed (right)

2.4 TD52XW Rear Housing Orientation

The TD52XW is delivered in the wall mount orientation with the connections exiting below the display. The rear housing may be reversed so the connections exit above the display when the TD52XW is placed horizontally on a bench. To reverse the rear housing, remove the four Phillips head screws, carefully rotate the housing 180°, and reinstall the screws.

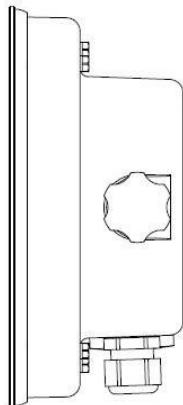

Figure 2-6 Wall Mount Configuration

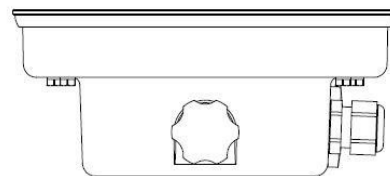

Figure 2-7 Bench Top Configuration

2.5 Mounting Bracket

Attach the bracket to a wall or table using fasteners (not supplied) that are appropriate for the type of mounting surface. The bracket will accommodate up to 6 mm (1/4") diameter screws. Locate the mounting holes as shown in Figure 2-8.

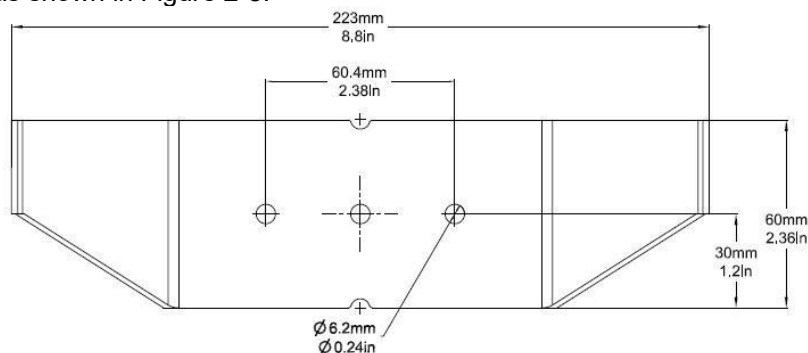

Figure 2-8 Mounting Bracket Dimensions

3. SETTINGS

3.1 Menu Structure

TABLE 3-1 MENU STRUCTURE

Calibration
Zero
Span
Linearity
GEO

Setup
Capacity Unit
Range
Capacity & Graduation
> 1 < Capacity
> 1 < Graduation
> 2 < Capacity
> 2 < Graduation
Language
Power On Zero
Power On Unit
Key Beep
Transaction Counter
Next Transaction
I/O Type
Reset

Read Out
Stability
Zero Range
Filter Level
Auto Zero Track
Auto Dim
Brightness
Screensaver
Auto Off
Adjust Contrast
Reset

Application Mode
Weighing
Counting
Check
Percent
Dynamic
Filling
Reset

Unit
Gram(g)
Kilogram(kg)
Pound(lb)
Ounce(oz)
Pound:Ounce (lb:oz)
Tonne(t)
Ton(ton)
Custom Unit
Unit Name
Factor
Exponent
LSD
Reset

GMP
Date Format
Date
Time Format
Time
Project ID
Scale ID
Reset

Communication		
RS232/ 2 nd RS232/USB Device*	Configuration	Baud Rate
		Parity
		Stop Bit
		Handshake
		Alt Print CMD
		Alt Tare CMD
		Alt Zero CMD
	Reset	
	Print Setup	Assignment
		Print Options
		Print Cal Data
		Select Template
		Edit Template
		Edit String
Reset		
RS485*	Configuration	Address
		Baud Rate
		Parity
		Stop Bit
		Handshake
		Alt Print CMD
		Alt Tare CMD
	Alt Zero CMD	
	Reset	
	Print Setup	Assignment
		Print Options
		Print Cal Data
		Select Template
		Edit Template
Edit String		
Reset		

Unit

GMP

Communication		
Ethernet*	Configuration	Host Name
		MAC Address
		Port
		Version
		DHCP
		IP Address
		Subnet Mask
		Gateway
		Primary DNS
		Secondary DNS
		Alt Print CMD
		Alt Tare CMD
		Alt Zero CMD
		Reset
	Print Setup	Assignment
		Print Options
		Print Cal Data
		Select Template
Edit Template		
Edit String		
Reset		
Wifi&Bluetooth*	Wifi	MAC Address
		Network
		Port
		DHCP
		IP Address
		Gateway
		DNS
		Subnet Mask
		Alternate Command
		Reset
	Bluetooth	Device name
	Print Setup	Assignment
		Print Options
		Print Cal Data
Select Template		
Edit Template		
Edit String		
Reset		
Analog*	Source	None , Displayed Weight, ABS-Displayed Weight, Gross Weight
	Output Type	4-20mA , 0-10V
	Zero Value	0(any valid value below the high limit)
	Full Scale Value	Desired source value, scale capacity
	Cal Output Zero	
	Cal Output Full	

SD Card/USB	
Library	
Memory	Mode
	Auto Print
	Save to
	Link to
User	User Profiles
	Supervisor Authority
	Password rule

Maintenance
Export Menu
Import Menu
Diagnosis
Format SD
Service Menu

Lock Key
Lock All Keys
Lock Off Key
Lock Zero Key
Lock Print Key
Lock Unit Key
Lock Soft Key
Lock Mode key
Lock Tare key
Lock Menu key
Reset

* Sub- menu for options will be active only when the specific board is installed.

Note: When you select Format SD in the maintenance menu, all the data in your SD card will be deleted.

The Bluetooth® word mark and logos are registered trademarks owned by Bluetooth SIG, Inc. and any use of such marks by OHAUS is under license.

3.2 Menu Navigation

To enter the Main Menu, press the button  from any application home screen.

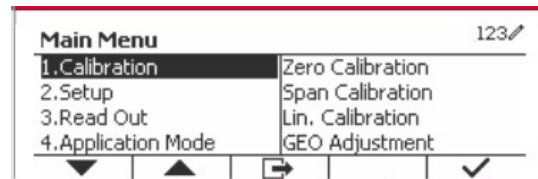



Changing Settings

To change a menu setting, navigate to that setting using the following steps:



1. Enter the Menu

From any Application screen, press the  button. The Main Menu List appears on the screen.

2. Select the Sub-menu

Scroll to the desired Sub-menu in the Main Menu List using the Softkey corresponding to the icon . Press the Softkey corresponding to the icon  to display the Sub-menu items.

3. Select the Sub-Menu Item

Scroll to the desired Sub-menu Item using the Softkey corresponding to the icon . Press the Softkey corresponding to the icon  to view the Sub-menu item's settings.

4. Select the Setting

Scroll to the desired Setting using the Softkey corresponding to the icon .

Press the Softkey corresponding to the icon  to select the setting.

Press the Softkey corresponding to the icon  to return to the previous screen.

Press the Softkey corresponding to the icon  to exit the menu and return to the last active Application mode.

3.3 Calibration Menu

The TD52 indicator offers three calibration methods: Zero Calibration, Span Calibration and Linearity Calibration.

NOTES:

1. Make sure that appropriate calibration masses are available before calibration.
2. Make sure that the scale base is level and stable during the entire calibration process.
3. Calibration is unavailable with LFT set to ON.
4. Allow the Indicator to warm up for approximately 5 minutes after stabilizing to room temperature.
5. To abort calibration, press the Softkey corresponding to the icon 'X' anytime during the calibration process.
6. When any selection within the GMP menu is enabled, calibration results are automatically printed.

3.3.1 Zero Calibration

Zero calibration uses one calibration point. The zero calibration point is established with no weight on the scale. Use this calibration method to adjust for a different dead load without affecting the span or linearity calibration.

Calibration procedures:

Long press the button  to enter the Main Menu. Press the Softkey corresponding to the icon  to enter the Calibration sub-menu.

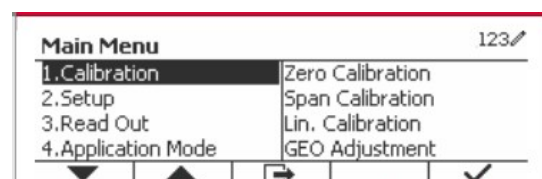

Zero Calibration is on the top of the list of Calibration by default. Just press the Softkey corresponding to the icon ✓ to initiate Zero Calibration.

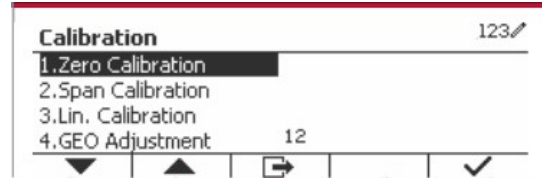

Clear the pan and then press the Softkey corresponding to the icon ✓.

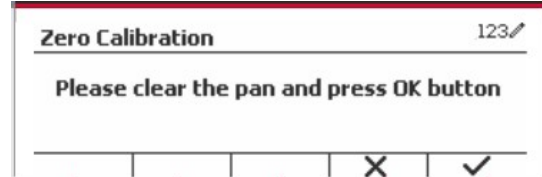

The message 'Completed' will be displayed on the screen.

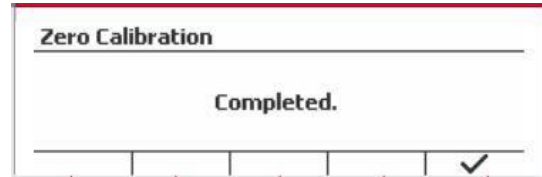

Exit Zero Calibration by pressing the Softkey corresponding to the icon ✓.

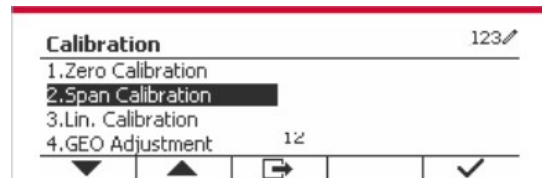

To return to the Main Menu, press the Softkey corresponding to the icon ✓.

3.3.2 Span Calibration

Span Calibration uses one point. The span calibration point is established with a calibration mass placed on the scale.

Note: Span Calibration should be performed after Zero Calibration.

Calibration procedures:

Long press the button  to enter the Main Menu.

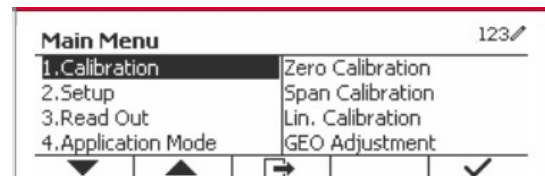

Press the Softkey corresponding to the icon ✓ to enter the Calibration sub-menu.

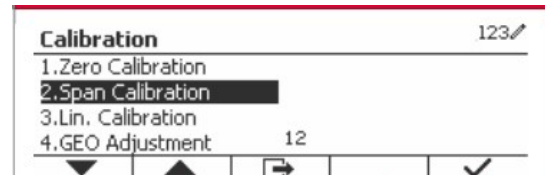

Scroll to Span Calibration using the Softkey corresponding to the icon ▼.

Press the Softkey corresponding to the icon ✓ to initiate Span Calibration. Place a calibration mass of the specified weight on the pan and press the Softkey corresponding to the icon ✓. To change to a different calibration point, input the value desired, and then place the corresponding weight on the pan for calibration.

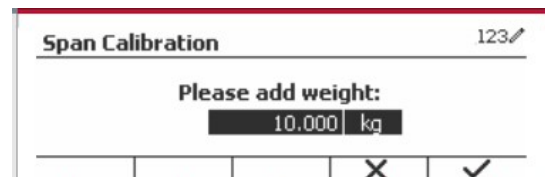

A suggestive message shows on the screen.

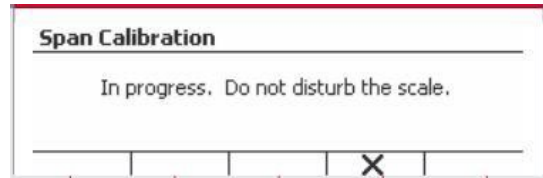

The message 'Completed' will be displayed on the screen.

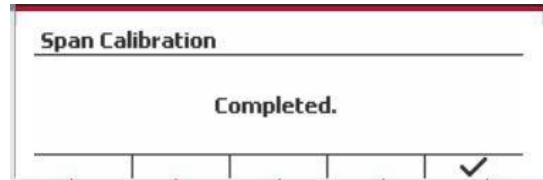

Exit Span Calibration by pressing the Softkey corresponding to the icon ✓.

To return to the Main Menu, press the Softkey corresponding to the icon ↩.

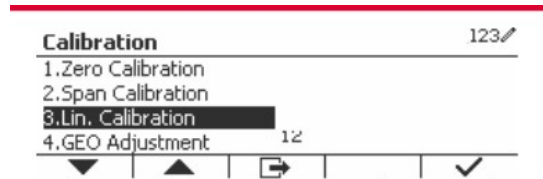

Note: Span Calibration should be performed after Zero Calibration.

3.3.3 Linearity Calibration

Linearity calibration uses 3 calibration points. The full calibration point is established with a weight on the scale. The mid calibration point is established with a weight equal to half of the full calibration weight on the scale. The zero calibration point is established with no weight on the scale. The full calibration and mid calibration points can be altered by the user during the calibration procedure.

Calibration procedures:

Long press the button  to enter the Main Menu.

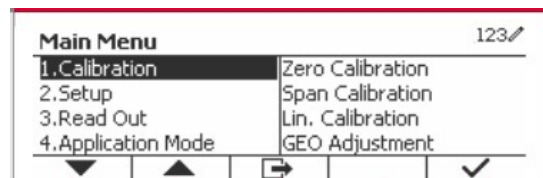

Press the Softkey corresponding to the icon ✓ to enter the Calibration sub-menu. Scroll to Linearity Calibration using the Softkey corresponding to the icon ▼.

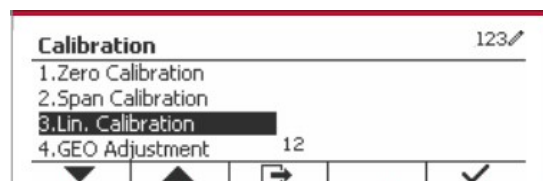

Press the Softkey corresponding to the icon ✓ to initiate Linearity Calibration.

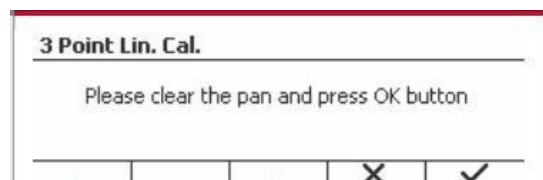

Clear the pan and press the Softkey corresponding to the icon ✓.

Put the calibration mass of the specified weight on the pan, and then press the Softkey corresponding to the icon ✓ for confirmation. To change to a different calibration point, input the value desired, and then place the corresponding weight on the pan for calibration.

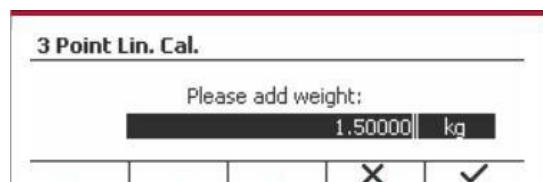

Put the calibration mass on the pan, and then press the Softkey corresponding to the icon ✓ for confirmation. To change to a different calibration point, input the value desired, and then place the corresponding weight on the pan for calibration.

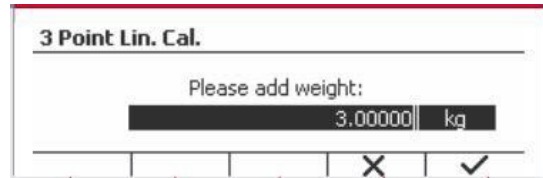

The message 'Completed' will be displayed on the screen.

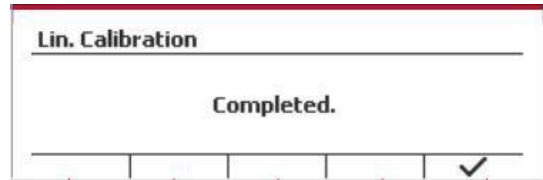

Exit Linearity Calibration by pressing the Softkey corresponding to the icon ✓.

To return to the Main Menu, press the Softkey corresponding to the icon ↩.

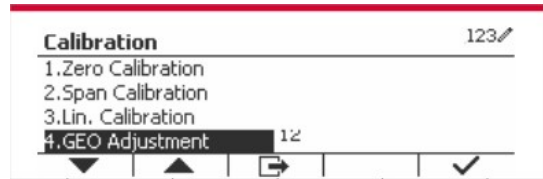

3.3.4 GEO Adjustment

Set the GEO factor that corresponds to your location. GEO codes are numbered 0-31.

Long press the button **User Menu** to enter the Main Menu. Select the menu item Calibration by pressing the Softkey corresponding to the icon ✓.

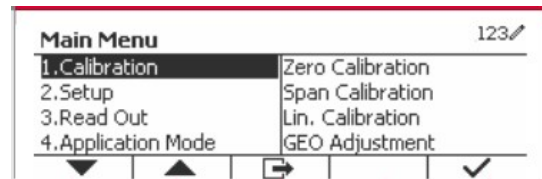

Scroll to GEO Adjustment using the Softkey corresponding to the icon ▼.

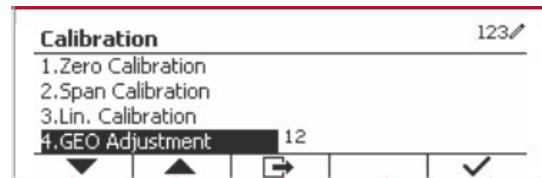

Press the Softkey corresponding to the icon ✓ to edit the GEO value. Press the button **On/CLR Off** and enter the desired value using the alphanumeric keypad. After editing, press the Softkey corresponding to the icon ↩ to exit the menu.

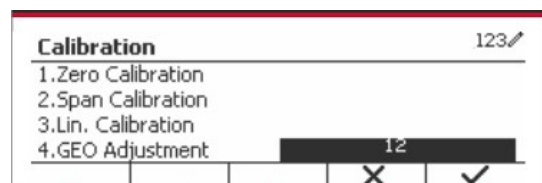

Note: See table 9-4 for GEO values.

3.4 Setup Menu

When the Indicator connects to a scale base for the first time, enter this menu to set the Capacity Unit, Range, Capacity and Graduation. Default settings are **bold**.

Setup	Options
Capacity Unit	g, kg , t (Metric Tonne), lb, ton (Short Ton)
Range	Single Interval , Dual Interval
> 1 < Capacity	1-999999
> 1 < Graduation	0.0001~100
> 2 < Capacity	1-999999
> 2 < Graduation	0.0001~100
Language	English , French, German, Italian, Spanish, Chinese, Japanese, Korean, Russian, Polish
Power On Zero	Off, On
Power On Unit	Auto , kg, lb, g, oz, lb:oz, t (Metric Tonne), ton (Short Ton), c
Key Beep	Off, On
Transaction Counter	Off, On
Next Transaction	1-9999999
I/O Type	Open , Closed
Reset	

3.4.1 Capacity Unit

Select the unit used for calibration.

- Kg**
- t (Metric Tonne)
- lb
- ton (Short Ton)
- g

3.4.2 Range

Set the number of weighing intervals in the weighing interval

The TD52 terminals can be configured to use single or dual interval. Each interval can be assigned its own graduation. If dual interval is selected, the graduation will change when the weight reaches the second interval.

When **Single** interval is selected, the additional parameters available are:

- >|1|< Capacity
- >|1|< Graduation

When **Dual** interval is selected, the terminal functions with two intervals, each with its own capacity and graduation. In addition to the Interval 1 capacity and graduation parameters, the following two parameters are available:

- >|2|< Capacity
- >|2|< Graduation

3.4.3 Capacity

Set the scale capacity from 1 to 999999.

>|1|< Capacity

Specify the weight capacity for interval 1. If **Single** interval is enabled, this will be the scale capacity. If **Dual** interval is enabled, this will be the first range.

>|2|< Capacity

Specify the weight capacity for interval 2. If **Dual** interval is enabled, this will be the scale capacity and it must be bigger than >|1|< Capacity. If **Single** interval is enabled, this parameter will not be shown.

3.4.4 Graduation

Set the scale readability from 0.0001 to 100.

>|1|<Graduation

Specify the graduation for weighing interval 1. If **Single** interval is enabled, this will be the graduation for the entire weighing range of the scale. If **Dual** interval is enabled, this will be the graduation used in the lower interval.

>|2|<Graduation

Specify the graduation for interval 2. If **Dual** interval is enabled, this will be the graduation for the second weighing range of the scale. If **Single** interval is enabled, this parameter will not be shown.

NOTE: Graduation settings are limited to values from Capacity divided by 600 to Capacity divided by 75000. Therefore, not all settings are available for each capacity.

3.4.5 Language

Set the language displayed for menus and displayed messages.

English

Deutsch

Français

Italiano

Polski

Spanish

한국

中文

日本語

3.4.6 Power On Zero

Zero the balance at Power On.

Off = disabled.

On = enabled.

3.4.7 Power On Unit

Set the unit that will be displayed at Power On.

Automatic

g

kg

lb

oz

lb:oz

t (Metric Tonne)

ton (Short Ton)

3.4.8 Key Beep

Set how the beeper sounds when a key is pressed.

Off = no sound

On = sound

3.4.9 Transaction Counter

The transaction counter is a seven-digit counter that tracks the total transactions. When the value reaches 9,999,999, the next transaction causes a roll-over to 0000001.

Off = the transaction counter will not increase.

On = the transaction counter will increase with the additional menu item Next Transaction available.

NOTE: If the transaction counter is set to be ON, the count number will increase when press print key.

3.4.9.1 Next Transaction

The value of the next transaction displays in the Next Transaction field.

3.4.10 I/O Type

Set the status of the relay output.

Open = The initial state of the relay output is normally open.

Closed = The initial state of the relay output is normally closed.

3.4.11 Reset

Reset the Setup menu to the factory defaults (except Range, Capacity and Graduation).

No = not reset.

Yes = reset.

NOTE: If the Security Switch is set to ON, the Capacity Unit, Range, Capacity, Graduation and Power On Zero settings are not reset.

3.5 Readout Menu

Enter this menu to customize display functionality. Default settings are **bold**.

Read Out	Options
Stability	0.5d, 1d , 2d, 5d
Zero Range	+/-2%, +/- 100%
Filter Level	Low, Medium , High
Auto Zero Track	Off, 0.5d , 1d, 3d
Backlight	Off, 1min , 2min, 5min, 10min, Always On
Screensaver	Off, 5min , 10min, 30min
Auto Off	Off , 5min, 10min, 30min
Adjust Contrast	1, 2, 3 , 4, 5
Reset	

3.5.1 Stability

Set the amount the reading can vary before the stability symbol turns off.

0.5d = 0.5 scale division

1d = 1 scale division

2d = 2 scale divisions

5d = 5 scale divisions

3.5.2 Zero Range

Set the percentage of scale capacity that may be zeroed.

2%

100%

NOTE: The setting is forced and locked to 2% when the Security Switch is set to the locked position.

3.5.3 Filter Level

Set the amount of signal filtering.

- Low = faster stabilization time with less stability.
- Medium** = normal stabilization time with normal stability.
- High = slower stabilization time with more stability.

3.5.4 Auto Zero Tracking

Set the automatic zero tracking functionality.

- OFF = disabled.
- 0.5division** = the display will maintain zero until a change of 0.5 division per second has been exceeded.
- 1d = the display will maintain zero until a change of 1 division per second has been exceeded.
- 3d = the display will maintain zero until a change of 3 divisions per second has been exceeded.

3.5.5 Auto Dim

Set the display backlight functionality.

Settings:

- 1 min** = backlight turns off after 1 minute of no activity.
- 2 min = backlight turns off after 2 minute of no activity.
- 5 min = backlight turns off after 5 minute of no activity.
- 10 min = backlight turns off after 10 minute of no activity.
- Always on
- Off

3.5.6 ScreenSaver

Set whether the screensaver is enabled after the selected time period.

- Off = Disabled.
- 5 min** = the screensaver is enabled after 5 minutes.
- 10 min = the screensaver is enabled after 10 minutes.
- 30 min = the screensaver is enabled after 30 minutes.

3.5.7 Auto Off

Set whether the display enters sleep mode after the selected time period.

- Off** = Disabled.
- 5 min = the display enters sleep mode after 5 minutes.
- 10 min = the display enters sleep mode after 10 minutes.
- 30 min = the display enters sleep mode after 30 minutes.

3.5.8 Adjust Contrast

Set the contrast degree of the display.

- 1
- 2
- 3**
- 4
- 5

3.5.9 Reset

Reset all settings to factory default settings.

- Yes = Reset.
- No** = Do not reset.

NOTE: If the Security Switch is set to ON, Stability, Zero Range, Filter Level and Auto Zero Track settings are not reset.

3.6 Discrete I/O

Long press the button  to enter the Main Menu.

Select Application Mode by pressing the Softkey corresponding to the icon .

Press the Softkey corresponding to the icon  to enter the sub-menu Application Mode.

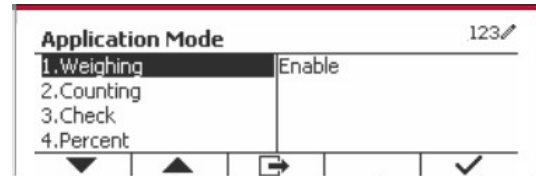
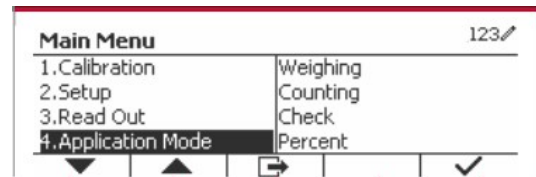

Enable

The current selected application mode can't be set Off.

Discrete I/O setup menus allow the configuration of 2 inputs and 4 outputs depending on different application mode.

Reset

If Reset is selected and confirmed, all the submenu value will be set to default.

For more details, see the table below.

Application Mode & Discrete I/O	Options (bold is default)	
Weighing	Enable	On , Off
	Discrete Input1	Off , Zero, Tare, Clear Tare, Print, Unit, Accumulate
	Discrete Input2	Off , Zero, Tare, Clear Tare, Print, Unit, Accumulate
	Discrete Output1	Off , Overload, Underload, Zero
	Discrete Output2	Off , Overload, Underload, Zero
	Discrete Output3	Off , Overload, Underload, Zero
	Discrete Output4	Off , Overload, Underload, Zero
Counting	Enable	On , Off
	Discrete Input1	Off , Zero, Tare, Clear Tare, Print, Unit, Accumulate
	Discrete Input2	Off , Zero, Tare, Clear Tare, Print, Unit, Accumulate
	Discrete Output1	Off , Overload, Underload, Zero
	Discrete Output2	Off , Overload, Underload, Zero
	Discrete Output3	Off , Overload, Underload, Zero
	Discrete Output4	Off , Overload, Underload, Zero
Check	Enable	On , Off
	Discrete Input1	Off , Zero, Tare, Clear Tare, Print, Unit, Accumulate
	Discrete Input2	Off , Zero, Tare, Clear Tare, Print, Unit, Accumulate
	Discrete Output1	Off , Under, Over, Accept, Under/Over, Overload, Underload, Zero
	Discrete Output2	Off , Under, Over, Accept, Under/Over, Overload, Underload, Zero
	Discrete Output3	Off , Under, Over, Accept, Under/Over, Overload, Underload, Zero
	Discrete Output4	Off , Under, Over, Accept, Under/Over, Overload, Underload, Zero
Percent	Enable	On , Off
Dynamic	Enable	On , Off
	Discrete Input1	Off , Zero, Tare, Clear Tare, Print, Start, Reset
	Discrete Input2	Off , Zero, Tare, Clear Tare, Print, Start, Reset
	Discrete Output1	Off , Overload, Underload, Zero
	Discrete Output2	Off , Overload, Underload, Zero
	Discrete Output3	Off , Overload, Underload, Zero
	Discrete Output4	Off , Overload, Underload, Zero
Filling	Enable	On , Off
	Discrete Input1	Off , Zero, Tare, Clear Tare, Print, Start/Stop, Pause/Continue
	Discrete Input2	Off , Zero, Tare, Clear Tare, Print, Start/Stop, Pause/Continue
	Discrete Output1	Off , SP1, SP2, SP3, SP4, Alarm, Zero
	Discrete Output2	Off , SP1, SP2, SP3, SP4, Alarm, Zero
	Discrete Output3	Off , SP1, SP2, SP3, SP4, Alarm, Zero
	Discrete Output4	Off , SP1, SP2, SP3, SP4, Alarm, Zero
Reset		

3.7 Weighing Unit

Enter this menu to activate the desired units. Default settings are **bold**.

NOTE: Due to national laws, the indicator may not include some of the units of measure listed. If the Security Switch is set to ON, the Units are locked at their current setting.

3.7.1 Gram (g)

Set the status.

Off = Disabled

On = Enabled

3.7.2 Kilogram (kg)

Set the status.

Off = Disabled

On = Enabled

3.7.3 Pound (lb)

Set the status.

Off = Disabled

On = Enabled

3.7.4 Ounce (oz)

Set the status.

Off = Disabled

On = Enabled

3.7.5 Pound: Ounce (lb: oz)

Set the status.

Off = Disabled

On = Enabled

3.7.6 Tonne (Metric Tonne)

Set the status.

Off = Disabled

On = Enabled

3.7.7 Ton (Short Ton)

Set the status.

Off = Disabled

On = Enabled

3.7.8 Custom Unit (c)

Use the Custom Unit to display weight in an alternative unit of measure. The custom unit is defined using a conversion factor, where the conversion factor is the number of custom units per gram expressed in scientific notation (Factor x 10^{Exponent}).

Factor

Set the conversion factor using the numeric keypad.

Settings of 0.1000000 to 1.9999999 are available. The default setting is 1.0.

Exponent

Set the factor multiplier.

-3 = divide the Factor by 1000 (1x10⁻³)

- 2 = divide the Factor by 100 (1×10^{-2})
- 1 = divide the Factor by 10 (1×10^{-1})
- 0** = multiply the Factor by 1 (1×10^0)
- 1 = multiply the Factor by 10 (1×10^1)
- 2 = multiply the Factor by 100 (1×10^2)

Least Significant Digit (LSD)

Set the graduation.

Settings of 0.5, 1, 2, 5, 10, 100 are available.

The Custom Unit's name can be customized up to 3 characters.

Note: Custom Unit is locked at Off position when the Security Switch is set to the locked position. Custom Unit is not available when Range is set to Dual interval.

Set the status.

Off = Disabled

On = Enabled

3.8 GLP/GMP Menu

Enter this menu to set the Good Laboratory Practice (GLP) or Good Manufacturing Practice (GMP) data.

3.8.1 Date Format

Set the date format.

MM/DD/YYYY = Month.Day.Year

DD/MM/YYYY = Day.Month.Year

YYYY/MM/DD = Year.Month.Day

3.8.2 Date

Set the date.

00 to 9999 = year position

01 to 12 = month position

01 to 31 = day position

Refer to Section 3.2 Menu Navigation to enter settings.

3.8.3 Time Format

Set the time format.

24 hr = 24 hour format.

12 hr = 12 hour format.

3.8.4 Time

Set the time.

24 hour format

00 to 23 = hour position

00 to 59 = minute position

3.8.5 Project ID

Set the Project identification.

Refer to Section 3.2 Menu Navigation to enter settings.

3.8.6 Scale ID

Set the Project identification.

Refer to Section 3.2 Menu Navigation to enter settings.

3.8.6 Reset

If Reset is selected and confirmed, all the submenu value will be set to default.

3.9 Communication

Enter this menu to define external communication methods and to set printing parameters. Data may be output to either a printer or PC.

Factory default settings are shown in **bold**.

3.9.1 RS232/2nd RS232 Configuration

Communication		Options(bold is default)		
RS232/2nd RS232	Configuration	Baud Rate	300, 600, 1200, 2400, 4800, 9600 , 19200, 38400, 57600	
		Parity	7 Even, 7 Odd, 7 None, 8 None	
		Stop Bit	1 bit , 2 bit	
		Handshake	None , Xon/Xoff, Hardware	
		Alt Print CMD	'a' ~ 'z', 'A' ~ 'Z', P	
		Alt Tare CMD	'a' ~ 'z', 'A' ~ 'Z', T	
		Alt Zero CMD	'a' ~ 'z', 'A' ~ 'Z', Z	
		Reset	No /Yes	
	Print Setup	Assignment	Demand	
			Stable Only	Off , On (LFT Force On)
			Auto On Stable	
			Mode	Load , Load and Zero
			Auto On Accept	
			Interval	
			Time	1~50000
			MT-Continuous	
			OH-Continuous	
			SICS	
			Reference Balance	
			Select Template	Simple , Custom 1, Custom 2, Custom 3, Custom 4, Custom 5
Print Cal Data	OFF , On			
Edit Template	Field 1~ Field 50			
Edit String	String 1~ String 20			
Reset				

3.9.1.1 Baud Rate

Set the baud rate (bits per second).

300
600
1200
2400
4800
9600
19200

3.9.1.2 Parity

Set the data bits and parity.

7 EVEN = 7 data bits, even parity
7 ODD = 7 data bits, odd parity
7 NONE = 7 data bits, no parity
8 NONE = 8 data bits, no parity

3.9.1.3 Stop Bits

Set the stop bits.

1 BIT
2 BIT

3.9.1.4 Handshake

Set the flow control method.

NONE = no handshaking
XON/XOFF = XON/XOFF handshaking
HARDWARE = hardware handshaking (COM1 menu only)

3.9.1.5 Alternate Print Command

Set the alternate command character for Print.

Settings of A(a) to Z(z) are available. The default setting is **P**.

3.9.1.6 Alternate Tare Command

Set the alternate command character for Tare.

Settings of A(a) to Z(z) are available. The default setting is **T**.

3.9.1.7 Alternate Zero Command

Set the alternate command character for Zero.

Settings of A(a) to Z(z) are available. The default setting is **Z**.

3.9.1.8 Reset

Reset the settings to factory default.

3.9.2 Print Setup of RS232/2nd RS232

3.9.2.1 Demand

If **Demand** is selected, the sub-menu **Stable Only** will display.

Set the printing criteria.

OFF = values are printed immediately, regardless of stability.
ON = values are printed only when the stability criteria are met.

Note: For more detailed information, please refer to Section 5.3 Printout.

3.9.2.2 Auto On Stable

If **Auto On Stable** is selected, the sub-menu **Mode** will display.

Set the printing mode.

Load = Prints when the displayed load is stable.
Load and Zero = Prints when the displayed load and zero reading is stable.

3.9.2.3 Auto On Accept

If **Auto On Accept** is selected and the weighing mode is **Check**, values will be printed when the weight is accepted.

ACCEPT = printing occurs each time the display is within the Checkweigh accept range and stability criteria are met.

3.9.2.4 Interval

If **Interval** is selected, the sub-menu **Time** will display.

INTERVAL = printing occurs at the defined time interval.

The time interval can be set through the numeric keypad. Settings of 1 to 3600 seconds are available. Default is 1. Printing occurs at the defined time interval.

3.9.2.5 MT-Continuous

If **MT-Continuous** is selected, the print output will be in the **MT-Continuous** format.

CONTINUOUS = printing occurs continuously.

Note: Refer to Appendix A for **MT-Continuous** format.

Checksum

Off = disabled

On = enabled

3.9.2.6 OH-Continuous

If **OH-Continuous** is selected, the print output will be in the **OH-Continuous** format.

Note: Refer to Appendix A for **OH-Continuous** format.

CONTINUOUS = printing occurs continuously.

3.9.2.7 SICS

OFF = disable MT-SICS command

ON = enable MT-SICS command

Note: Refer to Appendix B for **SICS** commands.

3.9.2.8 Reference Balance

OFF = do not connect to reference balance

ON = connect to reference balance

Note: Use a reference balance to perform sampling with a high resolution balance in Counting Mode. Please make sure the balance is already switched on before connected to the TD52 indicator.

3.9.2.9 Print Option

Set the way to print.

Printer = print the result through a printer.

PC = transfer the result to a computer.

3.9.2.10 Print Cal Data

Set the automatic Calibration Data printing functionality.

OFF = disabled

ON = enabled

3.9.2.11 Select Template

This sub-menu is used to define the format of the data output to a printer or computer.

Simple = only prints result and unit

Custom 1 = customized printout format. If not customized, Simple template will be used

Custom 2 = customized printout format. If not customized, Simple template will be used

Custom 3 = customized printout format. If not customized, Simple template will be used

Custom 4 = customized printout format. If not customized, Simple template will be used

Custom 5 = customized printout format. If not customized, Simple template will be used

3.9.2.12 Edit Template

This sub-menu is used to edit the current Print template. Each template supports up to 50 data fields to define the format of the data output.

Select the string number in the first selection box then any existing data for that string will be shown in the second entry box. Using the alphanumeric keys, enter or edit the characters to be used as the selected string.

To format a template, first select the field number (from 1 to 50) in the first selection box then select the item for that field in the second selection box. Using this method, a template of up to 50 fields can be created. To terminate a template, an End of Template field must be included. All fields after the End of Template field will be ignored.

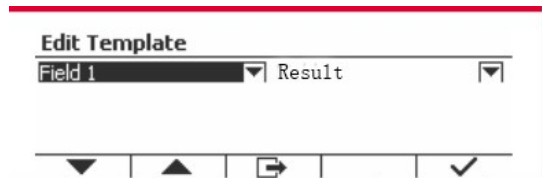

Item	Length
3 spaces	3
10 spaces	10
15 spaces	15
Date	10
Displayed Weight	23
End of Template	0
Gross Weight	23
User Name	Up to 31
Net Weight	23
New Line (<CR><LF>)	2
Information	Not fixed
Project ID	Up to 40
Serial number	10
Scale ID	Up to 40
Result	23 or 29(under check)
Mode	Up to 14
PN (Library)	Up to 30
Input status	2(00)
Transaction ID	7

Item	Length
String 1	Not fixed, up to 40
String 2	Not fixed, up to 40
String 3	Not fixed, up to 40
String 4	Not fixed, up to 40
String 5	Not fixed, up to 40
String 6	Not fixed, up to 40
String 7	Not fixed, up to 40
String 8	Not fixed, up to 40
String 9	Not fixed, up to 40
String 10	Not fixed, up to 40
String 11	Not fixed, up to 40
String 12	Not fixed, up to 40
String 13	Not fixed, up to 40
String 14	Not fixed, up to 40
String 15	Not fixed, up to 40
String 16	Not fixed, up to 40
String 17	Not fixed, up to 40
String 18	Not fixed, up to 40
String 19	Not fixed, up to 40
String 20	Not fixed, up to 40
Tare Weight	23
Time	5
Alibi #	6
Total	Not fixed
Library Name	Not fixed, up to 30
Displayed Digit	13
Output status	4(1111)
ID	Not fixed, up to 40

3.9.2.13 Edit String

Up to 20 Strings can be edited using the alphanumeric keypad.

Select the string number in the first selection box then any existing data for that string will be shown in the second entry box. Using the alphanumeric keys, enter or edit the characters to be used as the selected string.

String 1 = **OHAUS** (Default)

String 2 = **T52** (Default)

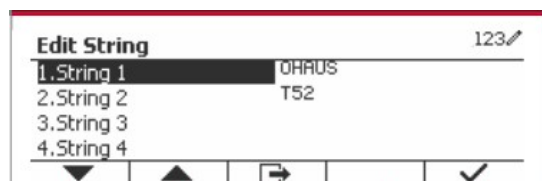

3.9.2.14 Reset

Reset the settings to factory default.

3.9.3 RS485 Configuration

Please refer to RS485 Configuration in the *Defender® 5000 RS232/RS485/USB Interface Instruction Manual*.

3.9.4 Ethernet Configuration

Please refer to Configuration in the *Defender® 5000 Ethernet Interface Instruction Manual*.

3.9.5 Wifi Configuration

Please refer to Wifi Configuration in the *Defender® 5000 USB Host Instruction Manual*.

3.9.6 Bluetooth Configuration

Please refer to Bluetooth Configuration in the *Defender® 5000 USB Host Instruction Manual*.

Note: When you select Bluetooth, the pin code window will only be displayed in measuring modes.

3.9.7 Analog Configuration

Please refer to Analog Configuration in the *Defender® 5000 Analog Kit Instruction Manual*.

3.10 Maintenance Configuration

Please refer to Service Manual TD52P TD52XW indicator for Service Menu information.

3.11 Lock Key Configuration

This menu is used to lock access to certain keys. When you select ON for one selection, the associated key press will be ignored.

If you select Lock All Keys, you will lose function of all keys.

If you select Lock Off key, you will lose function of the Off key.

Item	Available Settings (bold is the default settings)
Lock All Keys	Off , On
Lock Off Key	Off , On
Lock Zero Key	Off , On
Lock Print Key	Off , On
Lock Unit Key	Off , On
Lock Soft Key	Off , On
Lock Mode key	Off , On
Lock Tare key	Off , On
Lock Menu key	Off , On
Reset	No /Yes

Note: If the Menu key has been locked, Please refer to Service Manual TD52P TD52XW indicator for more information.

4. OPERATION

The scale can be configured to operate in up to 5 Application modes (Scale can be set to have 1 or more Applications modes active). Press the button **Mode** to select an activated application. The current application will be shown in the upper left corner of the home screen.

TD52 Indicator incorporates the following Applications:



4.1 Weighing

Use this application to determine the weight of items in the selected unit of measure.

Press the button **Library Mode** until the icon corresponding to **Weighing** is displayed in the screen (this application is the default). Press **Tare** or **Zero** if necessary to begin.



Place objects on the pan to display the weight. When the reading is stable, the * appears. The resulting value is displayed in the screen in the active unit of measure.

4.1.1 Application Setup

The Application can be customized for various user preferences. Press the button corresponding to the icon **Key** to enter **Configuration**.

The **Configuration** screen is now displayed. Select the list item and press the Softkey corresponding to the icon **Checkmark** to change the setting as desired.

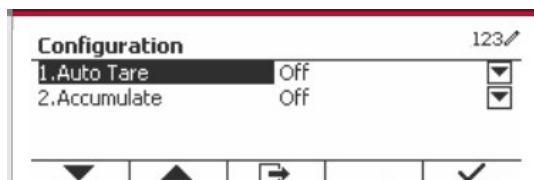

To return to the Application home screen, press the Softkey corresponding to the icon **Home**.

The Weighing Configurations are defined below (defaults in **Bold**)

Item	Available Settings	Comments
Auto Tare	On, Off	To enable Automatic Tare
Accumulate	Off , Automatic, Manual	To enable Accumulation / Totalization

4.1.2 Auto Tare

Set the automatic tare.

Off: Auto tare is turned off.
 On: The first stable weight (>=5d) will be tare as a container automatically.

Note: If the Security Switch is set to ON, Auto Tare is locked at the current setting.

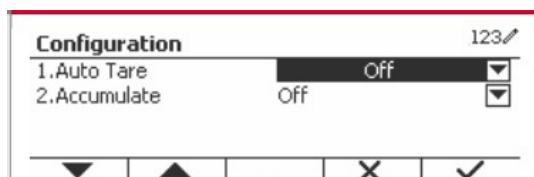

4.1.3 Accumulation

To start **Accumulate** weighing data, place the object on the pan and press the Softkey corresponding to the icon . The accumulation icon will start blinking. The load to be accumulated has to be $\geq 10d$ and the next accumulation can only start once the pan has been cleared.

When LFT is ON (no such limitation when LFT is OFF or LFT is ON and the approved mode is OIML),

- Gross weight and Net weight cannot be accumulated at the same time – only Gross weight or Net Weight can be accumulated;
- After a weighment, the Gross weight on the pan has to reach 0 before a new sample can be accumulated.

Note: The Accumulation icon  will only be shown if **Accumulate** is set to **Manual** and **Automatic** (see section 4.1.1).

Viewing the Accumulation Results

To view the accumulation results, press the Softkey corresponding to the icon . The **Accumulate Result** screen is displayed.

To clear the accumulation results, press the button .

When the instructional message "Clear the statistical data?" appears, press the Softkey corresponding to the icon .

To return to home screen press the Softkey corresponding to the icon . Press the button **Print** to print Accumulation result.

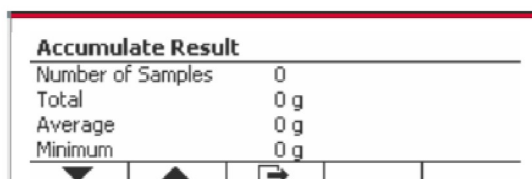
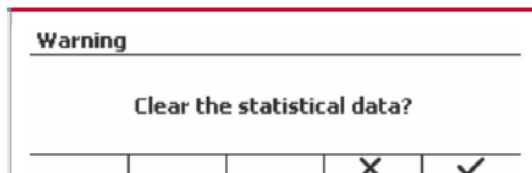
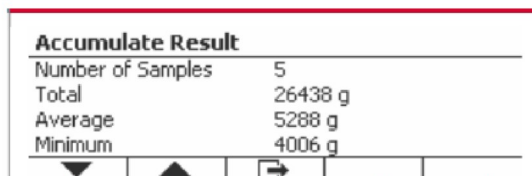
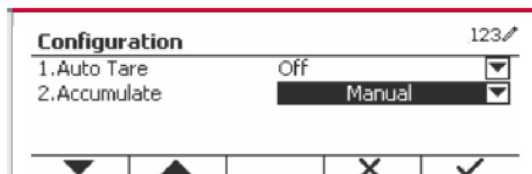
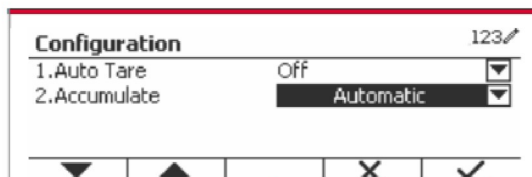
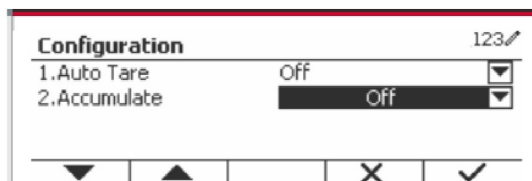

4.1.4 ID Input

Press Softkey corresponding to the icon **ID** to enter configuration screen. User can press alphanumeric keys to input the ID number. Then press the Softkey corresponding to the icon **ID** to confirm the input.

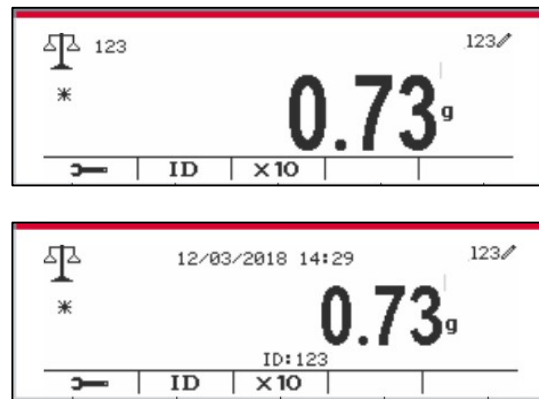

4.1.5 Input/Output (I/O) Setup

The I/O's setup can be customized for various user preferences. The I/O's setup is defined below (defaults in **Bold**).

Item	Available Settings
Enable	On , Off
Discrete Input 1	Off , Zero, Tare, Clear Tare, Print, Unit, Accumulate
Discrete Input 2	Off , Zero, Tare, Clear Tare, Print, Unit, Accumulate
Discrete Output 1	Off , Overload, Underload, Zero
Discrete Output 2	Off , Overload, Underload, Zero
Discrete Output 3	Off , Overload, Underload, Zero
Discrete Output 4	Off , Overload, Underload, Zero

Note: The I/O's will only work when the I/O Option Board has been installed. See the Accessory list in section 9.2 for information.

The option I/O board provides two isolated inputs and four dry-contact normally open relay outputs which can be used for simple process weighing.

Press the button **User Menu** to enter the Main Menu. With the button corresponding to the icon **▼**, go down the list and highlight **Application Mode**. Enter this sub-menu by pressing the button corresponding to the icon **✓**.

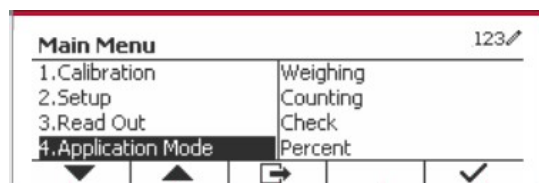

In the Application Mode menu enter the **Weighing** sub-menu.

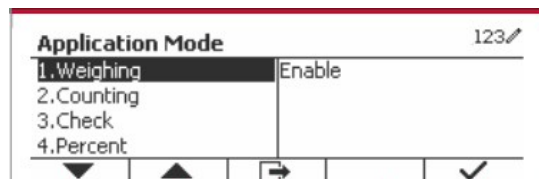

The Weighing sub-menu is now displayed. Select the list item and press the button corresponding to the icon **✓** to change the setting as desired. After completion of I/O's setup, press the Softkey corresponding to the icon **→** to return to the main application screen.

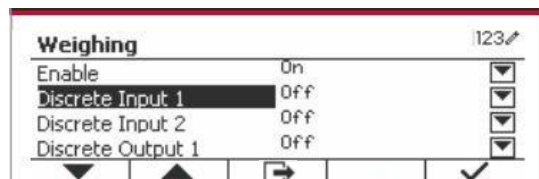

4.2 Counting

Use this application to count samples of uniform weight.

Press the button  until the icon corresponding to **Counting** is displayed in the screen.

The default (or last) Average Piece Weight (APW) is displayed.

Set the APW value according to section 4.2.1 and then place objects on the pan to display the number of pieces.

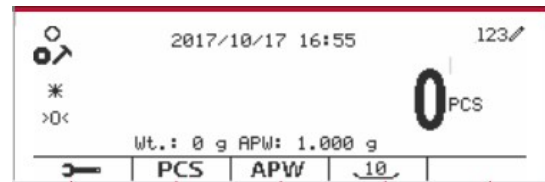

4.2.1 Set the Average Piece Weight (APW)

Note: It is recommended that the APW is larger than 1d. If APW is between 0.05d and 1d, a warning message will be displayed and the information line will show 'APW is too small!'. If APW is less than 0.05d, an error message will appear and the APW value cannot be stored.

There are two methods to set the APW:

1. Entering a Known APW

Method 1

Key in the Piece Weight using the alphanumerical keypad.

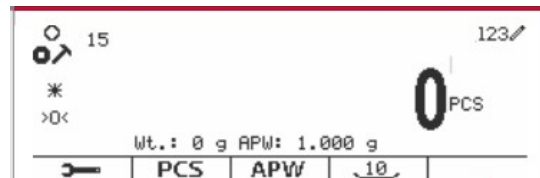

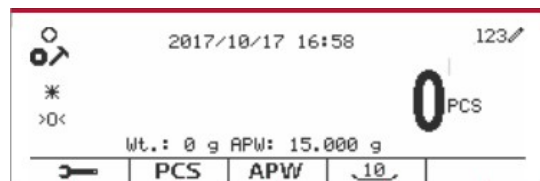

Then press the Softkey corresponding to the icon .



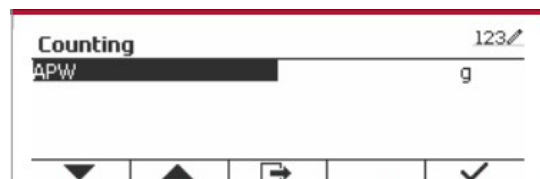

Method 2

Alternatively, first press the Softkey corresponding to the icon  to enter the sub-menu for setting the APW.

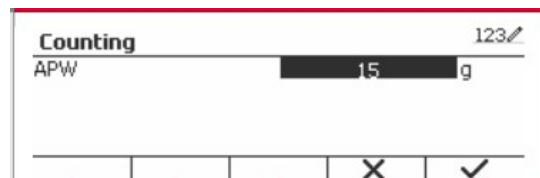

Press the Softkey corresponding to the icon  to edit the APW value using the alphanumerical keypad.



After editing, press the Softkey corresponding to the icon  for confirmation, and then press the Softkey corresponding to the icon  to exit the sub-menu.

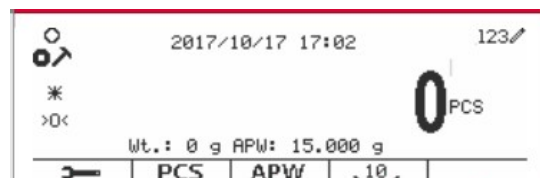

2. Calculating an APW

Method 1

Place the sample on the pan and then key in the number of pieces using the alphanumerical keypad.

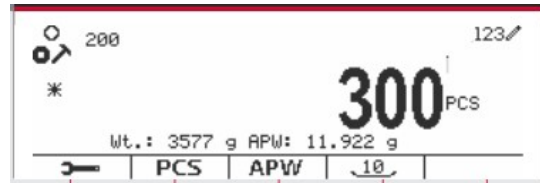

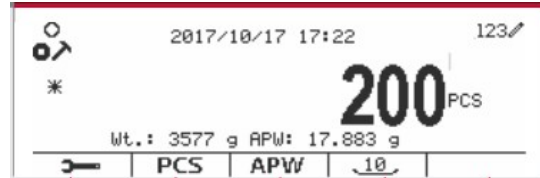

Press the Softkey corresponding to the icon  for confirmation. The terminal will calculate the new APW using the number of pieces.



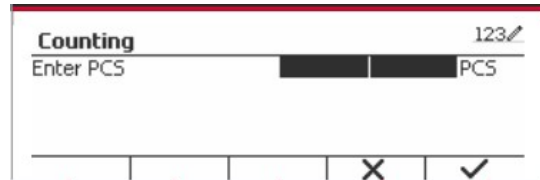

Method 2

Press the Softkey corresponding to the icon  to enter the sub-menu for setting the number of pieces.

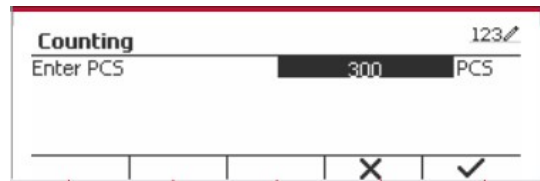

Press the Softkey corresponding to the icon  to edit the PCS value using the alphanumerical keypad.



After editing, press the Softkey corresponding to the icon  for confirmation, and then press the Softkey corresponding to the icon  to exit the sub-menu.

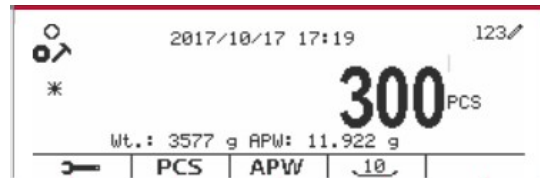

4.2.2 Application Setup

The Application can be customized for various user preferences.

Press the Softkey corresponding to the icon  to enter **Configuration**.

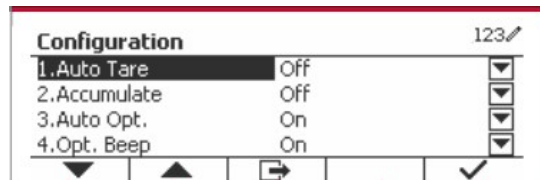

The **Configuration** screen is now displayed. Select the list item and press the Softkey corresponding to the icon  to change the setting as desired.

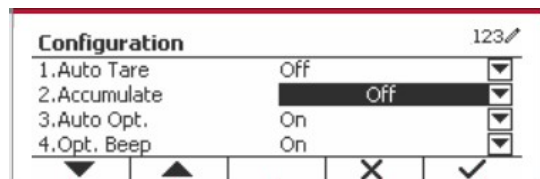

To return to the Application home screen, press the button corresponding to the icon .

The Counting Configurations are defined below (defaults in **Bold**).

Configure Item	Option(Bold is default)	Description
Auto Tare	Off/On	Off: Auto tare is turned off. On: The first stable weight (>=5d) will be tared as a container automatically.
Accumulate	Off/Manual/Automatic	Off: The icon "Σ" does not display. Manual: The Softkey "Σ" displays. User can press the key to accumulate the stable weight. Automatic: The icon "Σ" displays. The weight will be accumulated automatically. Note: The load to be accumulated has to be >= 5d and the next accumulation can only start once the pan has been cleared. When LFT is ON (no such limit when LFT is OFF or the approve mod is OIML), a. gross weight and net weight cannot be accumulated; b. gross 0 has to be reached before a new sample accumulation. When LFT is OFF, a. gross weight and net weight can be accumulated; b. a new sample can be accumulated after reaching gross 0 or net 0.
Auto Opt.	Off/On	Off: Auto Opt. is off. On: The APW will be optimized automatically during count weighing.
Opt. Beep	Off/On	Off: Opt. Beep is off. On: When the APW has to be optimized, the beeper will beep once.
APW Auto Save	Off/On	Off: APW Auto Save is off. On: If the APW is derived from sampling, and a counting library is selected, the new APW will be saved to library after optimized. Note: It will be hidden when "Auto Opt." is off.
Internal Resolution	Off/On	Off: Internal Resolution is off. On: During sampling or weighing, the internal resolution will be used.
Reference Size	10	The One Button Sampling PCS is from 0 to 999, the default is 10. 0: The One Button Sampling key will be hidden.

4.2.3 Accumulation

See section 4.1.3 for details about the Accumulation feature.

4.2.4 Input/Output (I/O) Setup



The I/O's setup can be customized for various user preferences.

The I/O's setup is defined below (defaults in **Bold**).

Item	Available Settings
Enable	On, Off
Discrete Input 1	Off, Zero, Tare, Clear Tare, Print, Unit, Accumulate
Discrete Input 2	Off, Zero, Tare, Clear Tare, Print, Unit, Accumulate
Discrete Output 1	Off, Overload, Underload, Zero
Discrete Output 2	Off, Overload, Underload, Zero
Discrete Output 3	Off, Overload, Underload, Zero
Discrete Output 4	Off, Overload, Underload, Zero

Note: The I/O's will only work when the I/O Option Board has been installed. The option I/O board provides two isolated inputs and four dry-contact normally open relay outputs which can be used for simple process weighing.

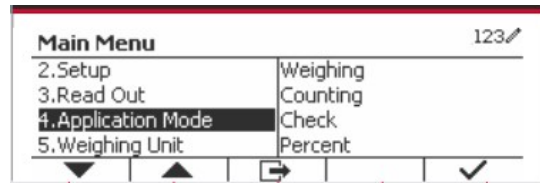

Press the button **User Menu** to enter the Main Menu.

With the button corresponding to the icon , go down the list and highlight **Application Mode**. Enter this sub-menu by pressing the button corresponding to the icon .

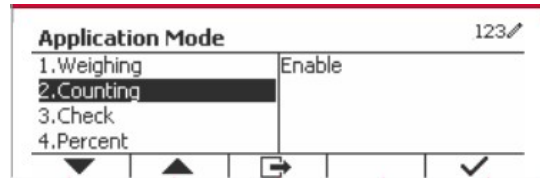

In the Application Mode menu enter the **Counting** sub-menu.



Select the list item and press the button corresponding to the icon  to change the setting as desired. After completion of I/O's setup, press the Softkey corresponding to the icon  to return to the main application screen.

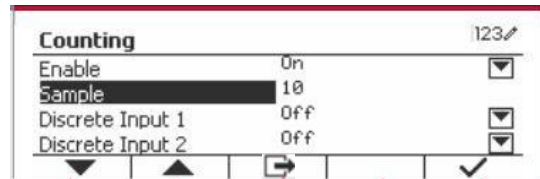

4.3 Check

Check is used to compare the weight or pieces of a sample against target limits.

Press the button **Library Mode** until the icon corresponding to **Check** is displayed in the screen. Two different modes can be selected in the **Check Mode**: Weighing, Counting.

Setup check limits according to section 4.3.1 or 4.3.2. Place object on the pan to check if the weight is within the limits.

4.3.1 Check Weighing (default)

Make sure that the **Check** mode is set to **Check Weighing** in the configuration menu.

Place objects on the pan. The **Under/Accept/Over** status is shown in the progress bar area while the actual weight of the item is shown on the main Display Line.

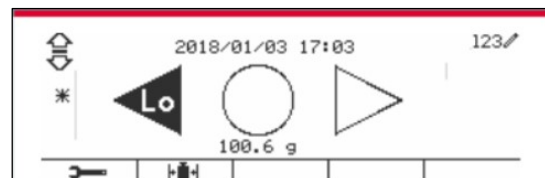

Defining Over/Under Limits

Press the button **Edit Limit** to define the limit for weighing.

Select Over or Under Limit and press the button corresponding to the icon  to edit the value.

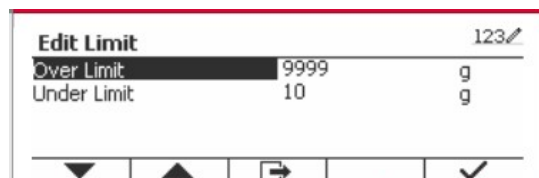

The Check Configurations are defined below (defaults in **Bold**).

Configure Item	Option(Bold is default)	Description
Check Mode	Check Weighting / Check Counting	Check weighting mode Check counting mode
Auto Tare	Off /On/Accept	Off : Auto tare is turned off. On: The first stable weight (>=5d) will be tared as a container automatically. Accept: If the object weight is in the range of the Over and Under Limit you set, auto tare will be performed.
Accumulate	Off /Manual/Automatic	Off : The icon "Σ" does not display. Manual: The icon "Σ" displays. User can press the key to accumulate the stable weight. Automatic: The icon "Σ" displays. The weight will be accumulated automatically. Note: The load to be accumulated has to be >= 10d and the next accumulation can only start once the pan has been cleared. When LFT is ON(no such limit when LFT is OFF or the approve mod is OIML), a. gross weight and net weight cannot be accumulated; b. gross 0 has to be reached before a new sample accumulation. When LFT is OFF, a. gross weight and net weight can be accumulated; b. a new sample can be accumulated after reaching gross 0 or net 0.
Audible Signal	Off /Under and Over/Accept/Under/Over	Off : No beep. Under and Over/Accept/Under/Over: Beep when reaching the selected check point.

4.3.2 Check Counting

Press the configuration button  and select Check Mode to Check Counting. Place objects on the pan. The **Under/Accept/Over** status is shown in the progress bar area while the actual number of pieces is shown on the main Display Line.



Set the Average Piece Weight (APW)

Note: It is recommended that the APW is larger than 1d. If APW is between 0.05d and 1d, a warning message will be displayed and the information line will show 'APW is low!'. If APW is less than 0.05d, an error message will appear and the APW value cannot be stored.

There are three methods to set the APW, see section 4.2.2 for instructions.

Defining Over/Under Limits

Press the button **Edit Limit** to define the limit for counting.

Note: See section 4.3.1 for information on how to set the Over/Under limits.

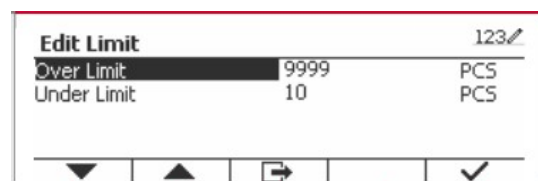

4.3.3 Application Setup

The Application can be customized for various user preferences.

Press the Softkey corresponding to the icon

 to enter **Configuration Setup**.

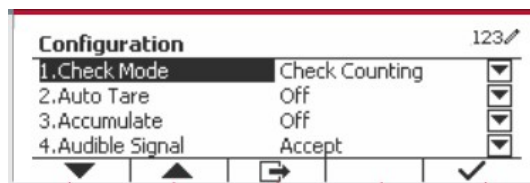

The **Configuration Menu** is now displayed.

Select the list item and press the Softkey corresponding to the icon , to change the setting as desired.

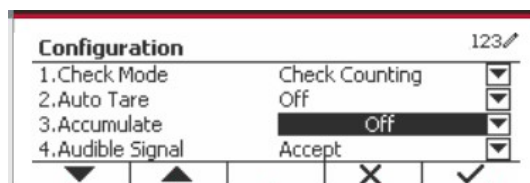

To return to the Application home screen, press the button corresponding to the icon .

The Check Configurations are defined below (defaults in **Bold**).

Configure Item	Option (Bold is default)	Description
Check Mode	Weighting /Counting	Weighting : Check weighing mode. Counting: Check counting mode.
Auto Tare	Off /On/Accept	Off : Auto tare is turned off. On: The first stable weight (>=5d) will be tared as a container automatically. Accept: If the object weight is in the range of the Over and Under Limit you set, auto tare will be performed.
Accumulate	Off /Manual/Automatic	Off : The Softkey "Σ" does not display. Manual: The Softkey "Σ" displays. User can press the key to accumulate the stable weight. Automatic: The Softkey "Σ" displays. The weight will be accumulated automatically. Note: The load to be accumulated has to be >= 10d and the next accumulation can only start once the pan has been cleared. When LFT is ON(no such limit when LFT is OFF or the approve mod is OIML), a. gross weight and net weight cannot be accumulated; b. gross 0 has to be reached before a new sample accumulation. When LFT is OFF, a. gross weight and net weight can be accumulated; b. a new sample can be accumulated after reaching gross 0 or net 0.
Audible Signal	Off/Under and Over/ Accept /Under/Over	Off: No beep. Under and Over/ Accept /Under/Over: Beep when reaching the selected check point.
Auto Opt.	Off/ On	Off: Auto Opt. is off. On : The APW will be optimized automatically when doing count weighing.
Opt. Beep	Off/ On	Off: Opt. Beep is off. On : When the APW is optimized, the beeper will beep once.
APW Auto Save	Off/ On	Off: APW Auto Save is off. On : If the APW is get from sampling, and a counting library is selected, the new APW will save to library after optimized.

4.3.4 Input/Output (I/O) Setup



The I/O's setup can be customized for various user preferences.

The I/O's setup is defined below (defaults in **Bold**).

Item	Available Settings
Enable	On , Off
Discrete Input 1	Off , Zero, Tare, Clear Tare, Print, Unit, Accumulate
Discrete Input 2	Off , Zero, Tare, Clear Tare, Print, Unit, Accumulate
Discrete Output 1	Off , Under, Over, Accept, Under/Over, Zero
Discrete Output 2	Off , Under, Over, Accept, Under/Over, Zero
Discrete Output 3	Off , Under, Over, Accept, Under/Over, Zero
Discrete Output 4	Off , Under, Over, Accept, Under/Over, Zero

Note: The I/O's will only work when the I/O Option board has been installed. The option I/O board provides two isolated inputs and four dry-contact normally open relay outputs which can be used for simple process weighing.

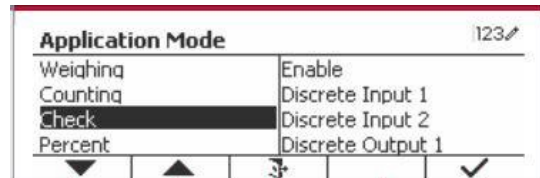

Press the button  to enter the Main Menu.

With the button corresponding to the icon , go down the list and highlight **Application Mode**. Enter this sub-menu by pressing the button corresponding to the icon .

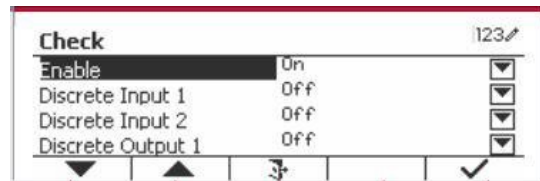

In the Application Mode menu enter the **Check** sub-menu.



The **Check** sub-menu is now displayed. Select the list item and press the Softkey corresponding to the icon  to change the setting as desired. After completion of I/O's setup, press the Softkey corresponding to the icon  to return to the main application screen.

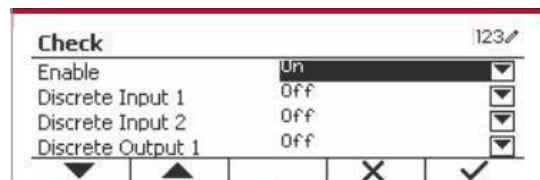

4.4 Percent Weighing

Use Percent Weighing to measure the weight of a sample displayed as a percentage of a pre-established Reference Weight.

Press the button  until the icon corresponding to **Percent** is displayed in the upper left portion of the home screen.

Establish a reference weight according to section 4.4.1 and then place the objects on the pan to display the percentage.

The default (or last) Reference Weight is displayed on the main screen.

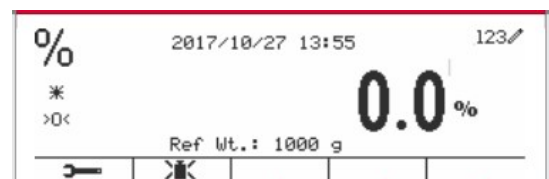



4.4.1 Establishing a Reference Weight

There are 3 methods to establish a reference weight:

Method 1

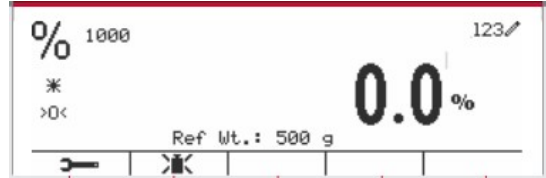
Key in the reference weight value using the alphanumerical keypad.



Press the Softkey corresponding to the icon  for confirmation.



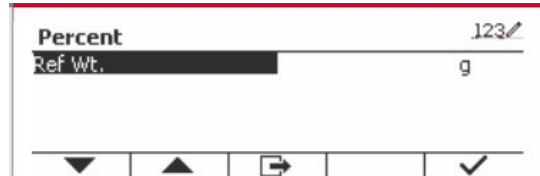

Method 2

Press the Softkey corresponding to the icon  to enter the sub-menu for setting the reference weight.

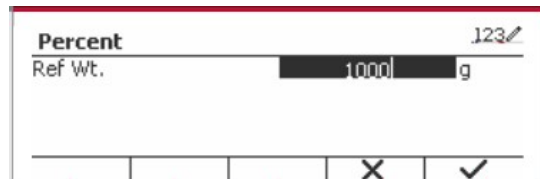

Enter the desired value using the alphanumerical keypad.



Press the Softkey corresponding to the icon  to save the value and press the Softkey corresponding to the icon  to exit the sub-menu.

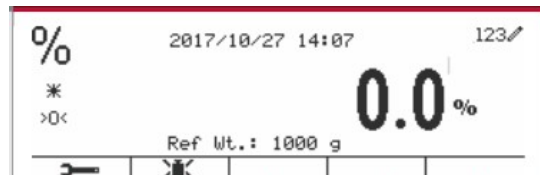

Method 3

Place the reference weight on the pan and press the button corresponding to the icon  .

4.4.2 Application Setup

The Application can be customized for various user preferences.

Press the Softkey corresponding to the icon  to enter **Configuration**.

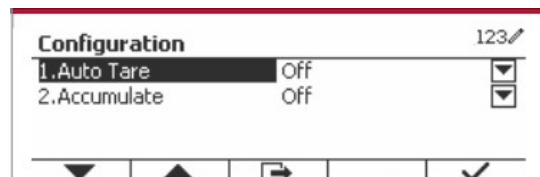

Select the list item and press the Softkey corresponding to the icon ✓ to change the settings as desired.

To return to the Application home screen, press the Softkey corresponding to the icon ↩.

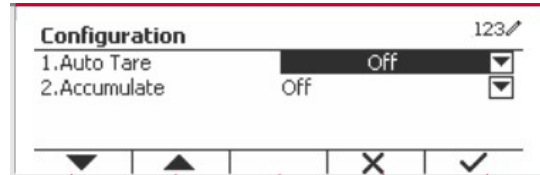

The Percent Configurations are defined below (defaults in **Bold**).

Configure Item	Option(Bold is default)	Description
Auto Tare	Off /On	Off : Auto tare is turned off. On: The first stable weight ($\geq 5d$) will be tared as a container automatically.
Accumulate	Off /Manual/Automatic	Off : The Softkey " Σ " doesn't display. Manual: The Softkey " Σ " displays. User can press the key to accumulate the stable weight. Automatic: The Softkey " Σ " displays. The weight will be accumulated automatically. Note: The load to be accumulated has to be $\geq 10d$ and the next accumulation can only start once the pan has been cleared. When LFT is ON (no such limit when LFT is OFF or the approved model is OIML), a. gross weight and net weight cannot be accumulated; b. gross 0 has to be reached before a new sample accumulation. When LFT is OFF, a. gross weight and net weight can be accumulated at the same time; b. a new sample can be accumulated after reaching gross 0 or net 0.

4.4.3 Input/Output (I/O) Setup

The I/O's setup can be customized for various user preferences.

The I/O's setup is defined below (defaults in **Bold**).

Item	Available Settings
Enable	On , Off

Note: The I/O's will only work when the I/O Option board has been installed. See the accessory list in section 9.2 for information. The option I/O board provides two isolated inputs and four dry-contact normally open relay outputs which can be used for simple process weighing.

Press the button User Menu to enter the Main Menu. With the Softkey corresponding to the icon ▼, go down the list and highlight **Application Mode**. Enter this sub-menu by pressing the button corresponding to the icon ✓.

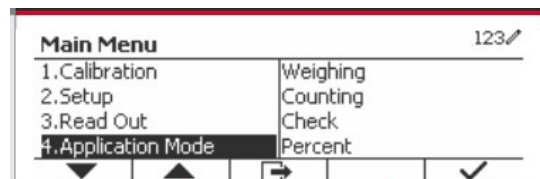

In the Application Mode menu, enter the **Percent** sub-menu.

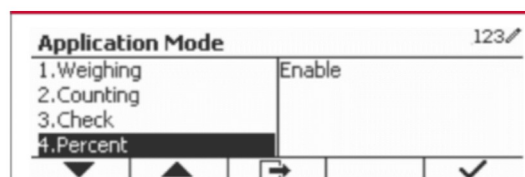

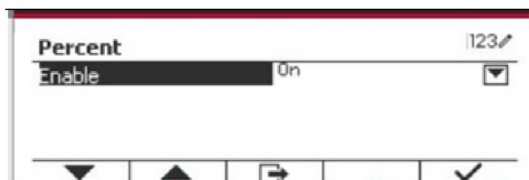

Select the list item and press the Softkey corresponding to the icon ✓ to change the setting as desired. After completion of I/O's setup, press the Softkey corresponding to the icon ↩ to return to the main application screen.



4.5 Dynamic Weighing

Use this application to weigh an unstable load, such as a moving animal. Three different start/reset operation type can be selected: **Manual** (start and stop via key press), **Semi-Automatic** (auto-start with manual reset), and **Automatic** (start and stop automatically).

Press the button  until the corresponding to **Dynamic** is displayed in the upper left portion of the home screen.

Press the Softkey corresponding to the icon  to start averaging.

To abort the averaging press the button corresponding to the icon .

When the averaging has finished, press the button corresponding to the icon  to reset.

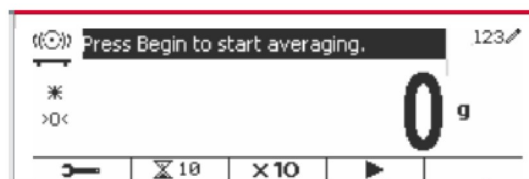

4.5.1 Application Setup

The Application can be customized for various user preferences.

Press the button corresponding to the icon  to enter **Configuration Menu**.

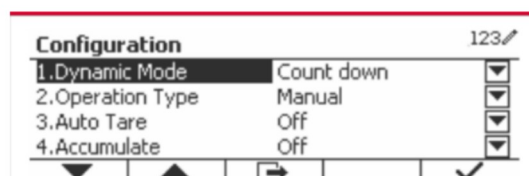

Select the list item and press the Softkey corresponding to the icon ✓ to change the setting as desired.

To return to the Application home screen, press the Softkey corresponding to the icon .

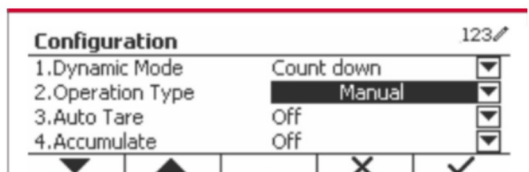

The Dynamic Configurations are defined below (defaults in **Bold**).

Configure Item	Option(Bold is default)	Description
Dynamic Mode	Count down /Continuous	Count down: There is a countdown time. Continuous: There is no countdown time.
Operation Type	Manual / Semi-Automatic/ Automatic	Manual: Place load on the pan. Press Softkey  to start the dynamic weighing and countdown. When the countdown is over, the average weight is displayed. Before doing next weighing, press Softkey "Reset". Semi-Automatic: Before weighing, the reading should be zero (Gross or Net). Place load (\geq Start Weight) on the pan, the dynamic weighing and countdown start automatically. When the countdown is over, the average weight is displayed. Before doing next weighing, press Softkey "Reset". Automatic: Before weighing, the reading should be zero (Gross or Net). Place load (\geq Start Weight) on the pan, the dynamic weighing and countdown start automatically. When the countdown is over, the average weight is displayed. After the load has been removed, the average weight still displays until the duration time is over. If the Softkey "Reset" is pressed, the average weight will be cleared immediately. Note: During the weighing countdown, if a weight error (under load / over load) is occurred, the weighing process will stop immediately. If "Auto Tare" is on, a container (weight $\geq 5d$) must place on the pan first. After the terminal has done tare automatically, place load on the pan to start dynamic weighing.
Start Weight	3.000 (with current unit)	If the operation type is Semi-Automatic/Automatic , this menu will be shown. If the load bigger than the weight, then the dynamic weighing will start.
Auto Tare	Off /On	Off: Auto tare is turn off. On: The first stable weight ($\geq 5d$) will be tared as the container weight.
Accumulate	Off /Manual/Automatic	Off: The Softkey " Σ " doesn't display. Manual: The Softkey " Σ " displays. User can press the key to accumulate the stable weight. Automatic: The Softkey " Σ " displays. The weight will be accumulated automatically.

Configure Item	Option(Bold is default)	Description
		<p>Note:</p> <ol style="list-style-type: none"> 1. The load to be accumulated has to be $\geq 10d$. Another accumulation can't be done until the pan is cleared ($< 5d$). 2. Gross weight and net weight can't be accumulated together when the LFT is ON (no such limit when the LFT is OFF or the approved model is OIML). When first accumulated value is gross weight (net weight), scale will enter into gross weight (net weight) accumulate mode. Otherwise, "Gross and net weight can't be accumulated" will be displayed. 3. If the LFT is ON, gross weight 0 has to be reached before a new sample can be accumulated. If the LFT is OFF, new sample can be accumulated after reaching gross weight 0 or net weight 0.
Duration Time	1 ~ 10 s	It is the time for the display to remain the dynamic weighing result after the load is removed.

4.5.2 Average Time Setup

There are two methods to set the averaging time.

The default Average Time is 10 seconds.

Note: When the time is set to 0, the first stable weight over 5d will be displayed.
 Averaging time can be set to a value between 0 and 20 seconds.

Method 1

1. Press the button corresponding to the icon  to enter the **Dynamic** sub-menu for changing the averaging time.

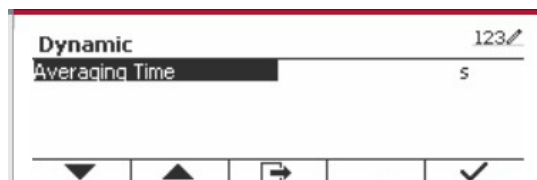

2. Press the Softkey corresponding to the icon  and then key in the desired value using the alphanumerical keypad.

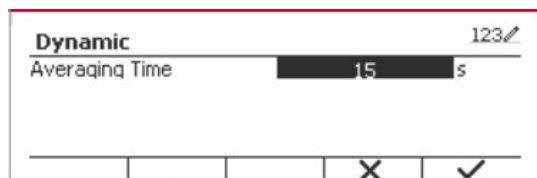

3. After setting the averaging value desired, press the Softkey corresponding to the icon  for confirmation.

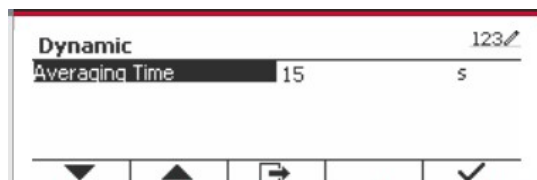

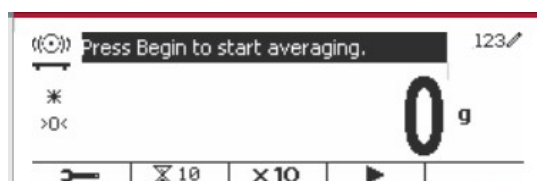

4. Press the Softkey corresponding to the icon  to exit the sub-menu.

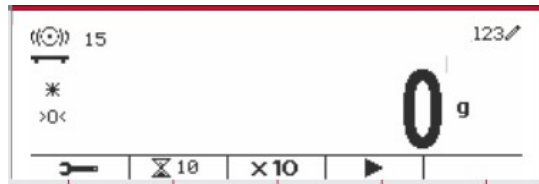

Method 2

1. Use the alphanumeric keypad to key in the desired averaging time.



2. Once the value keyed in is displayed in upper left portion of the screen, press the Softkey corresponding to the icon .

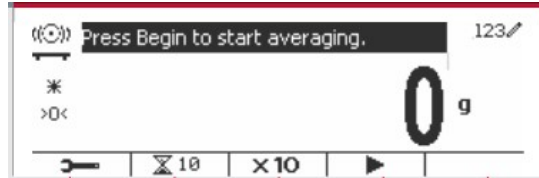



4.5.3 Input/Output (I/O) Setup

The I/O's setup can be customized for various user preferences. The I/O's setup is defined below (defaults in **Bold**).

Item	Available Settings
Enable	On , Off
Discrete Input 1	Off , Zero, Tare, Clear Tare, Print, Start, Reset
Discrete Input 2	Off , Zero, Tare, Clear Tare, Print, Start, Reset
Discrete Output 1	Off , Underload, Overload, Zero
Discrete Output 2	Off , Underload, Overload, Zero
Discrete Output 3	Off , Underload, Overload, Zero
Discrete Output 4	Off , Underload, Overload, Zero

Note: The I/O's setup will only work when the I/O Option board has been installed. See the Accessory list in section 9.2 for information. The option I/O board provides two isolated inputs and four dry-contact normally open relay outputs which can be used for simple process weighing.

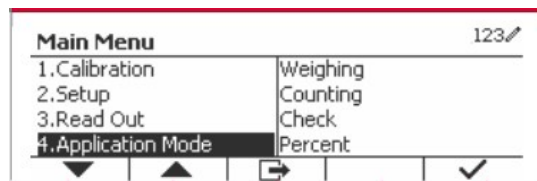

Press the button  to enter the Main Menu.

With the button corresponding to the icon , go down the list and highlight **Application Mode**. Enter this sub-menu by pressing the Softkey corresponding to the icon .

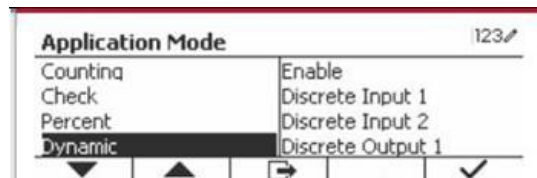

In the Application Mode menu enter the sub-menu **Dynamic**.



Select the list item and press the Softkey corresponding to the icon  icon to change the setting as desired. After completion of I/O Setup, press the Softkey corresponding to the icon  to return to the main application screen.

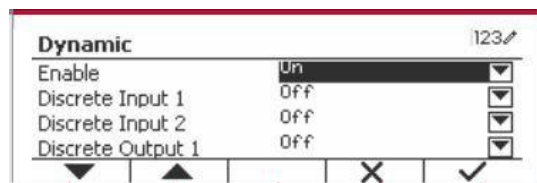

4.5 Filling

Use this application to fill a container to a pre-determined target weight.

Press the button  until the icon corresponding to Filling is displayed in the upper left portion of the home screen.

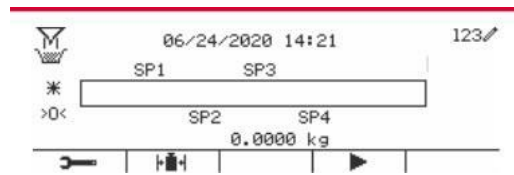

Establish the four target weights SP1, SP2, SP3 and SP4 according to section 4.5.1. Then place a container on the pan, perform tare and fill the container until all the four target weights are reached.



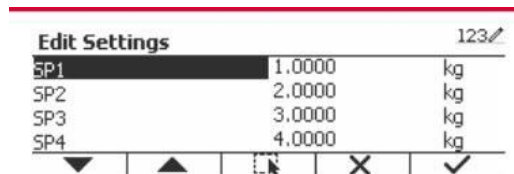

4.5.1 Establishing target weights

Press the Softkey corresponding to the icon  to enter the sub-menu for setting the target weight.

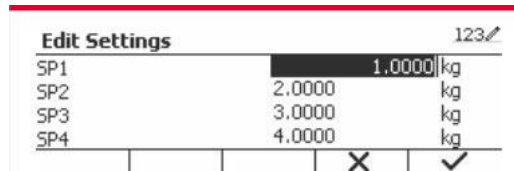

Press the Softkey corresponding to the icon  to input SP1's value. Input through the numeric keyboard and then press the icon  to confirm.



Repeat the step above to set values for SP2, SP3 and SP4. When you finish, press the Softkey corresponding to the icon  to confirm and exit the sub-menu.

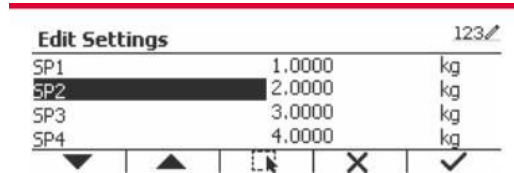



4.5.2 Application Setup

The Application can be customized for various user preferences.

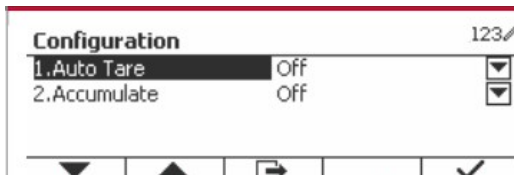
Press the Softkey corresponding to the icon  to enter **Configuration**.



Select the list item and press the Softkey corresponding to the icon  to change the settings as desired.

To return to the Application home screen, press the Softkey corresponding to the icon .

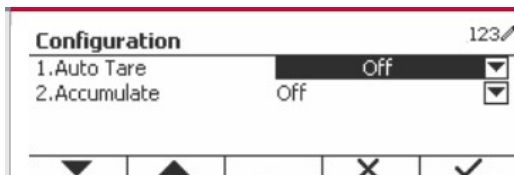

The Filling Configurations are defined below (defaults in **Bold**).

Configure Item	Option(Bold is default)	Description
Auto Tare	Off /On	Off : Auto tare is turned off. On: The first stable weight (>=5d) will be tared as a container automatically.
Accumulate	Off /Manual/Automatic	Off : The Softkey "Σ" doesn't display. Manual: The Softkey "Σ" displays. User can press the key to accumulate the stable weight. Automatic: The Softkey "Σ" displays. The weight will be accumulated automatically. Note: The load to be accumulated has to be >= 5d and the next accumulation can only start once the pan has been cleared. When LFT is ON (no such limit when LFT is OFF or the approved model is OIML), a. gross weight and net weight cannot be accumulated; b. gross 0 has to be reached before a new sample accumulation. When LFT is OFF, a. gross weight and net weight can be accumulated at the same time; b. a new sample can be accumulated after reaching gross 0 or net 0.

Note: please refer to 4.1.3 Accumulation in Weighing section for how to perform accumulation.

4.5.3 Input/Output (I/O) Setup

The I/O's setup can be customized for various user preferences. The I/O's setup is defined below (defaults in **Bold**).

Item	Available Settings
Enable	On , Off
Discrete Input 1	Off , Zero, Tare, Clear Tare, Print, Start/Stop, Pause/Continue
Discrete Input 2	Off , Zero, Tare, Clear Tare, Print, Start/Stop, Pause/Continue
Discrete Output 1	Off , SP1, SP2, SP3, SP4, Alarm, Zero
Discrete Output 2	Off , SP1, SP2, SP3, SP4, Alarm, Zero
Discrete Output 3	Off , SP1, SP2, SP3, SP4, Alarm, Zero
Discrete Output 4	Off , SP1, SP2, SP3, SP4, Alarm, Zero

Note: The I/O's setup will only work when the I/O Option board has been installed. See the Accessory list in section 9.2 for information. The option I/O board provides two isolated inputs and four dry-contact normally open relay outputs which can be used for simple process weighing.

Press the button  to enter the Main Menu.

With the button corresponding to the icon ▼, go down the list and highlight **Application Mode**. Enter this sub-menu by pressing the Softkey corresponding to the icon ✓.

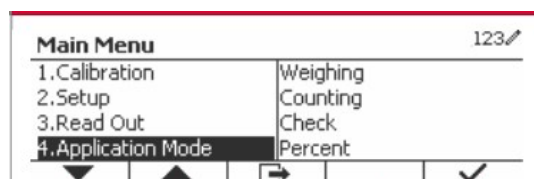

In the Application Mode menu enter the sub-menu **Filling**.

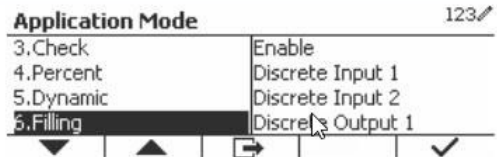

The screenshot shows a menu titled "Application Mode" with a page number "123" and a pencil icon. The menu items are:

Item	Value
3.Check	Enable
4.Percent	Discrete Input 1
5.Dynamic	Discrete Input 2
6.Filling	Discrete Output 1

At the bottom of the screen, there are four softkey icons: a downward arrow, an upward arrow, a rightward arrow, and a checkmark.

Select the list item and press the Softkey corresponding to the icon ✓ icon to change the setting as desired. After completion of I/O Setup, press the Softkey corresponding to the icon ↗ to return to the main application screen.

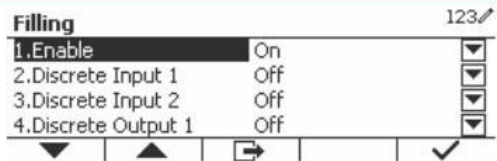

The screenshot shows a menu titled "Filling" with a page number "123" and a pencil icon. The menu items are:

Item	Value	Softkey
1.Enable	On	Down Arrow
2.Discrete Input 1	Off	Down Arrow
3.Discrete Input 2	Off	Down Arrow
4.Discrete Output 1	Off	Down Arrow

At the bottom of the screen, there are four softkey icons: a downward arrow, an upward arrow, a rightward arrow, and a checkmark.

5. SERIAL COMMUNICATION

5.1 Interface Command

The T52P and T52XW Indicators include a RS232 serial communication interface.

The setup of RS232 operating parameters are more fully explained in Section 3.10. The physical hardware connection is explained in Section 2.6.

The interface enables display and GMP data to be sent to a computer or printer. A computer can be used to control some functions of the indicator using the commands listed in Table 5-1.

The Indicator supports both MT-SICS and OHAUS commands. Commands listed in the following tables will be acknowledged by the indicator. To use the MT-SICS commands, send the command PSI. To return to the OHAUS commands, send the command POH.

SICS commands can also be active in the menu setup, please refer to Section 3.9.2.7 for detail.

OHAUS Commands

Command	Function
IP	Immediate Print of displayed weight (stable or unstable).
P	Print displayed weight (stable or unstable).
CP	Continuous Print
SP	Print on Stability.
xS	0S: Turn off "Stable Only" menu item and allow unstable print. 1S: Turn on "Stable Only" menu item and only print stable print.
xP	Interval Print x = Print Interval (1-50000 sec), 0P turns auto print OFF
Z	Same as pressing Zero Key.
T	Same as pressing Tare Key.
xT	Download Tare value in grams (positive values only). Sending 0T clears tare (if allowed).
PU	Print current unit: g, kg, lb, oz, lb:oz
xU	Set scale to unit x: 1=kg, 2=lb, 3=g, 4=oz, 5=lb:oz
xM	Set scale to mode x. 1=Weighing, 2=Counting, 3=Check, 4=Percent, 5=Dynamic. M will scroll to next enabled mode.
PSN	Print Serial Number.
CU xxx	Set Under Limit (only in Check mode) where 'xxx' is the value under current unit
CO xxx	Set Over Limit (only in Check mode) where 'xxx' is the value under current unit
x#	Set Counting APW (x) in grams. (only in Counting or Check Counting mode, must have APW stored)
P#	Print Counting or Check Counting mode APW.
x%	Set Percent mode reference weight (x) in grams (must have a weight stored)
P%	Print Percent mode reference weight.
PV	Version: print name, software revision and LFT ON (if LFT is set ON).
H x "text"	Enter String content, x = String number (1-10), "text" = string text up to 40 alphanumeric characters.
\EscR	Global reset to reset all menu settings to the original factory defaults.

5.2 RS232 Interface

RS232 (DB9) Pin Connections:

Pin 2: Scale transmit line (TxD)

Pin 3: Scale receive line (RxD)

- Pin 5: Ground signal (GND)
- Pin 7: Clear to send (hardware handshake) (CTS)
- Pin 8: Request to send (hardware handshake) (RTS)

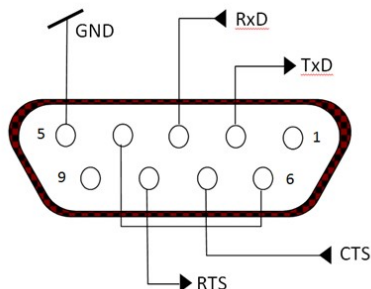

Use the built-in RS-232 Port to connect either to a computer or a printer

5.3 Connecting to a Computer

Connect to the computer with a standard (straight-through) serial cable. Use HyperTerminal or similar terminal software to test communication with the computer. Set up HyperTerminal as follows:

- Choose New Connection, “connect using” COM1 (or available COM port).
- Select Baud=9600; Parity=8 None; Stop=1; Handshaking=None. Click OK.
- Choose Properties/Settings, then ASCII Setup. Check boxes as illustrated: (Send line ends...; Echo typed characters...; Wrap lines...)

Verify communication by pressing the Print button. If HyperTerminal is set up properly, the value on the display will be displayed in the window.

5.4 Connecting to a Serial Printer

Connect the cable supplied with the printer to the scale’s RS-232 port. Make sure that the indicator and printer communication settings match. Test communication with the printer by pressing the Print button. If the indicator and printer are set up properly, the value on the display will be printed.

5.5 Printouts

Printout string for g, kg, lb, oz units:

Check Weighing application:

Field	Weight (Right aligned)	Space	Unit (Right aligned)	Space	Stability (?)	Space	T/N/G/PT (Right aligned)	Space	Application Status (Right aligned)	Term.
Length	11	1	5	1	1	1	2	1	6	2

Non-Check Weighing application:

Field	Weight (Right aligned)	Space	Unit (Right aligned)	Space	Stability (?)	Space	T/N/G/PT (Right aligned)	Term.
Length	11	1	5	1	1	1	2	2

Each field is followed by a single delimiting space (ASCII: 32).

Definitions:

Weight - Up to 11 characters, right justified, - at immediate left of most significant character (if negative).

Unit - Up to 5 characters, right justified. If the Unit in the Print Content menu was set to OFF, the unit will be removed in the weight string and replaced by spaces.

Stability - “?” character is printed if not stable. If weight is a space is printed.

T/N/G/PT - "T" is printed for a tare weight, "N" printed if weight is net weight, 'G' or nothing printed if weight is a gross weight, 'PT' is printed if the tare weight is Pre-set Tare.

Application Status (for Check) – Fixed to 6 characters. Display status like " Under", "Accept" and "Over" for check weighing.

Terminating Character(s) - terminating character(s) printed depending on FEED menu setting.

Printout string for the lb:oz unit

Field	Weight1	Space	Unit1	Space	Weight2	Space	Unit2	Space	Stability	Space	G/N	Space	Message	Term.Char(s)
Length	4	1	2	1	7	1	2	1	1	1	1	1	5	2

- The printout string has a fixed length of 28 characters.
- Each Space field is a delimiting space used to separate the other fields.
- The Weight1 field is 4 right justified characters. If the value is negative, the ' - ' character is located at the immediate left of the most significant digit.
- The Unit1 field is 2 left justified characters.
- The Weight2 field is 7 right justified characters.
- The Unit2 field is 2 left justified characters.
- The Stability field is 1 character. A space is printed if the weight value is stable. A '?' is printed if the weight value is not stable.
- The G/N field is 1 character. 'G' is printed for a gross weight. 'N' is printed for a net weight.
- The Message field is 5 left justified characters.

Note: The Termination Characters Carriage Return and Line Feed are appended to the printout.

5.6 Printout Examples

Setup in Menu	Print out
{String 1} {New Line} {String 2} {New Line} {String 3} {New Line} {New Line} {Time} {3 spaces} {3 spaces} {Date} {New Line} {ID} {New Line} {Result} {New Line} {New Line} {String 4} {New Line} {String 5} {New Line} {End of template}	OHAUS CORPORATION 7 Campus Drive Suite 310 10:01 04/22/2016 50 500.0 g Signature_____ Verified by_____

6. MICRO SD CARD/USB

SD Card/USB		Options(bold is default)
Library		Off, On
Memory	Enable	Off /Alibi/Editable
	Auto Print	Off , On
	Save to	SDCARD , USB
	Link to	RS232 /2ndRS232/RS485/Ethernet/Wifi/USB device
User	User Profiles	
	Supervisor Authority	
	Password rule	

Note: "SD Card" only displays when SD card is installed. It will format the SD Card when entering this submenu at first time.

6.1 Library

Each application supports up to 50,000 records. The applications (Weighing, Counting, Check and Filling) have libraries.

The Library can be cloned through below methods:

1. Copy all files inside the current micro SD card and export them to a new card.
2. Use ScaleMate software (version 2.1.0 or higher) to read all files in the Library.

Directory

Library	Weighing	D5000/Library
	Counting	D5000/Library
	Check	D5000/Library
	Filling	D5000/Library

Library Items

The libraries have several items PN, Name, Under, Over, APW, SP1, SP2, SP3, SP4, Tare Wt.

PN: The part number of the material (unique).

Name: The name of the material.

Under: The under limit of the check.

Over: The over limit of the check.

APW: The APW of the check.

Tare Wt.: The tare weight of the material.

SP1: the first target weight of Filling.

SP2: the second target weight of Filling.

SP3: the third target weight of the Filling.

SP4: the forth target weight of the Filling.

Only Weighing, Counting, Check have the library, and they have different items. See the table below:

Item Mode	PN	Name	Under	Over	APW	SP1	SP2	SP3	SP4	Tare Wt.
Weighing	X	X								X
Counting	X	X			X					X
Check*	X	X	X	X	X					X
Filling	X	X				X	X	X	X	X

* Only Checkcounting library has the APW value.

Library Display

For the product number shown on the lower right corner of the screen:

If the product number is more than 6 digits, the first five digits plus a "." will be shown.

If the product number is equal to or less than 6 digits, the complete number will be shown.



Enter Library

Press the **Library** button to enter library screen.

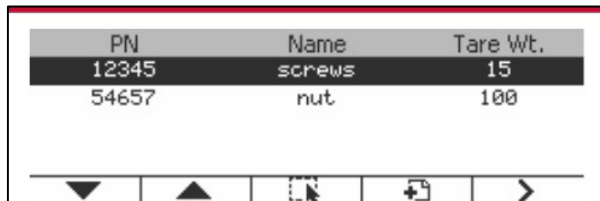

Create a new library

Press Softkey corresponding to the icon . The length of PN and Name is up to 32 digits of alphanumeric characters.

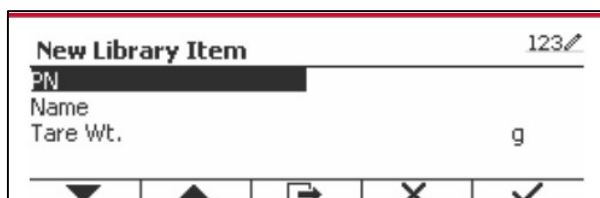
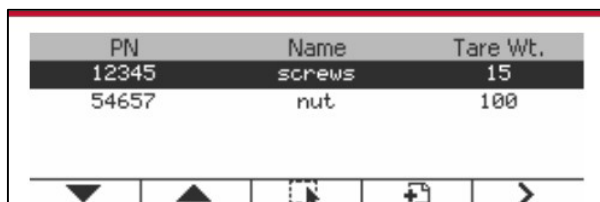

Search Library

Press the Softkey corresponding to the icon  .

PN	Name	Tare Wt.
12345	screws	15
54657	nut	100

Enter "PN" code by alphanumeric keys, and press the Softkey corresponding to the icon  to confirm the input.

Search 123 

PN

X

The search result displays on the screen.

PN	Name	Tare Wt.
12345	screws	15

Note: you can also search by entering part number and then pressing  button directly in measuring modes. The search result will be shown.

If the number of the results reaches 4, the records with the PN includes string "12345" are listed in the result. If the user press Softkey corresponding to the icon  , a new search will start.

PN	Name	Tare Wt.
12345	screws	15
123456	screws2	15
123457	screws3	15
123458	screws4	15

Recall Library

Press the Softkey corresponding to the icon  to recall library.

PN	Name	Tare Wt.
12345	screws	15
54657	nut	100
123456	screws2	15

Exit Library

Press the button  to exit library.

6.2 User

The scale has a user profile to manage the user. There are three kind of user role, Admin, Supervisor, Operator. They have different authority. The admin can add, edit and delete all users, but currently logged in user account cannot be deleted. The supervisor can add, edit and delete operators. The operator has no right to add, edit or delete any user, and this role can only recall library.

User Login

If there is a user in the user profile, it will show a login screen when the terminal starts up. You must enter the right password of the user, so you can login successfully. You can press "User" key to call login screen.

Press  button to confirm log in when you finish entering your user name and password.

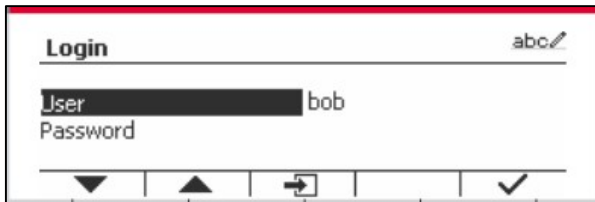

User Profile

Up to a maximum of 1000 users can be stored in the SD card. The user ID is from "000" to "999" and the user name contain 1~32 characters. The user ID is unique.

The directory is listed below:

	Directory
User	\\D5000\LIBRARY\USERLIB

If you reaches the maximum user amount, you can either format your SD card or delete the user profile folder in your computer.

Enter User Profile

Press the "User Profile" submenu to enter the user profile screen.

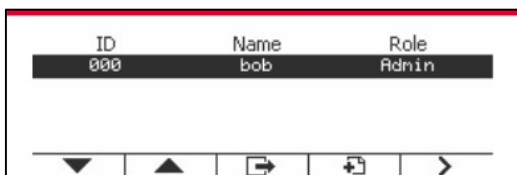

Add a New User

Press soft key  to enter new user screen. The first user must be admin user.

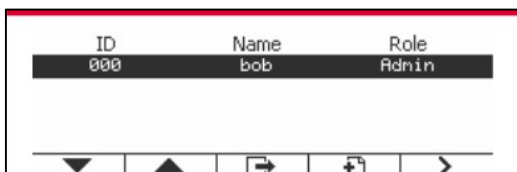

The user name is unique.

New User 001 123/

Role Admin

Name

Password

Confirm Password

New User 001 123/

Role Operator

Name

Password

Confirm Password

Search a User

Press the Softkey corresponding to the icon  to search the user.

ID	Name	Role
000	bob	Admin
001	martin	Operator

Input the "User Name" using the numeric key.

Search abc/

User Name bob

Press soft key  to confirm the "User Name" and start the search.

The result will display after the search is finished.

ID	Name	Role
000	bob	Admin

Edit & Delete a User

Press the Softkey corresponding to the icon  to enter the edit screen. The admin user can edit any user, and the supervisor just can edit operator. The account of the logged in user cannot be edited or deleted.

ID	Name	Role
000	bob	Admin
001	martin	Operator

Edit User 001 abc/

Role Operator

Name martin

Password *****

Confirm Password *****

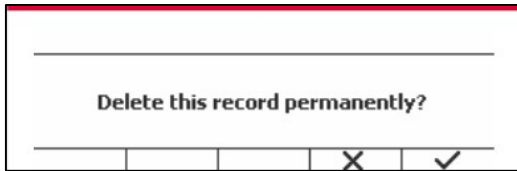

After the user has been deleted, the user id can't be reused. When the user id reach to "1000", a "User Full!" error message will show.

Supervisor Authority

The admin user can set the authority of the supervisor as following.

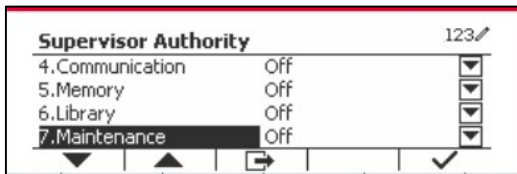
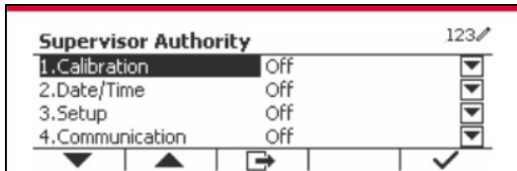

Password Rule

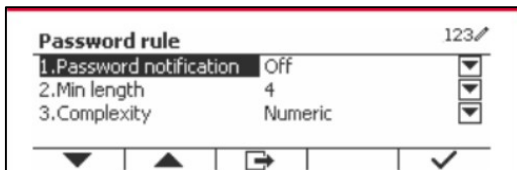

The password has a period of validity. A password change notification will show 15 days before the password validity period. If the period of validity has expired, user must change the password immediately when login.

The length of the password must bigger than the "Min length" and smaller than 32.

There is three complexities of the password.

Complexity	Password Character
Numeric	Numeric
Alpha numeric	Numeric & letter
Match case	Numeric & lowercase letter & upper case letter

6.3 Alibi

A SD memory card is necessary to use Alibi memory, or an error message will display (**SD card is not installed**).

If the Alibi option is set **On**, the additional menu item **Auto Print and Review** will display.

Each time a demand print is triggered or a "P" command is received, specific data fields include ID number, a stable reading, tare weight, date and time will be stored in Alibi memory.

If Auto Print is set to be **On**, Specific Interval Print data fields include ID number, a stable reading, tare weight, date and time will also be stored in the Alibi memory.

User can browse or search the Alibi record, and the Alibi record contains the following information:

- ID
- Gross /Net weight, tare weight and weight unit
- Date and time

One screen just can show one alibi record, and it shows the latest alibi firstly.

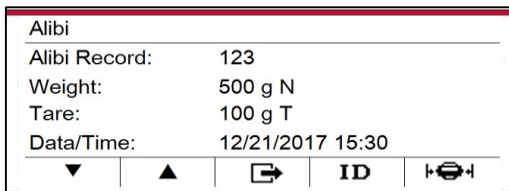

Press the **ID** button to enter the ID, and search the alibi record.

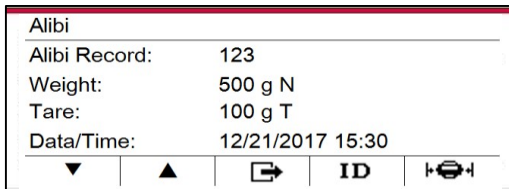
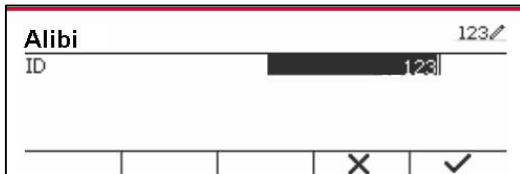

Press the **ID** button to enter an ID range.

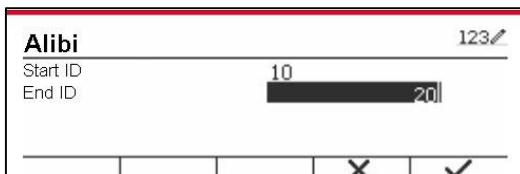
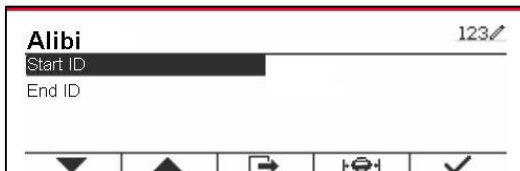

Press the  button to print out the selected alibi records to the serial port.

6.4 Editable

If the **Editable** is set On, the submenu **Save to** and **Link to** will display. The '**Save to**' contains SDCARD, USB. The default is SDCARD. The terminal will restart when menu is changed. The '**Link to**' contains **RS232**, 2nd RS232, RS485, Ethernet, Wi-Fi and USB device. The default is **RS232**.

The output printed to the interface above will be saved as a .txt file distinguished by month into SDCARD or USB flash device depending on the selection of the '**Save to**' menu. For example, 201612.txt is the data printed to the interface during Dec. 2016.

A SD memory card is necessary to use Editable memory, or an error message will display (SD card is not installed). Customer can only use either Alibi or Editable format to store the weighing result.

The file name and directory are listed below:

		File Name	Directory
SDCARD	Data	201612.txt	\D5000\DATA\
USB flash device	Data	201612.txt	/

When the '**Save to**' menu is set to USB, less than or equal to 32G flash device is recommended.

In addition, barcode scanner is also supported. Since there are many brands of barcode scanners in the market, OHAUS tested and confirmed that below Barcode scanners from Datalogic is compatible:

QuickScan series

7. LEGAL FOR TRADE

When the indicator is used in trade or a legally controlled application it must be set up, verified and sealed in accordance with local weights and measures regulations. It is the responsibility of the purchaser to ensure that all pertinent legal requirements are met.

7.1 Settings

Before verification and sealing, perform the following steps:

1. Verify that the menu settings meet the local weights and measures regulations.
2. Perform a calibration as explained in Section 3.
3. Turn the indicator off.

TD52XW:

1. Disconnect power from the indicator and open the housing as explained in Section 2.3.1.
2. Set the position of the security switch SW1 to ON as shown in Figure 1-3, item 5.
3. Close the housing.
4. Reconnect power and turn the indicator on.

TD52P:

1. Disconnect power from the indicator and remove security screw as shown in Figure 1-1, item 7.
2. Set the position of the security switch SW1 to ON.
3. Close the security switch.
4. Reconnect power and turn the indicator on.

7.2 Verification

The local weights and measures official or authorized service agent must perform the verification procedure.

7.3 Sealing

The local weights and measures official or authorized service agent must apply a security seal to prevent tampering with the settings. Refer to the illustrations below for sealing methods.

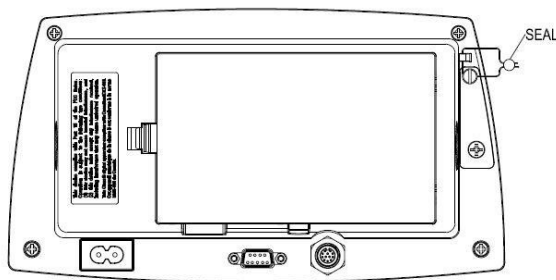

Figure 7-1. TD52P Wire Seal

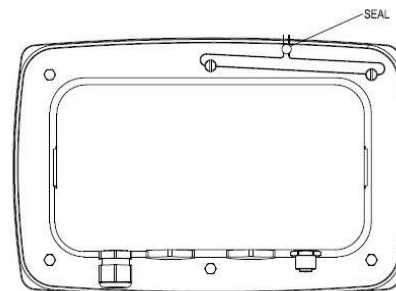

Figure 7-2. TD52XW Wire Seal

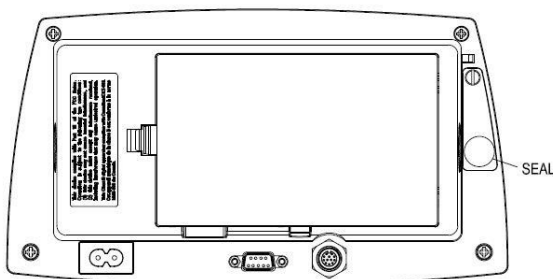

Figure 7-3. TD52P Paper Seal

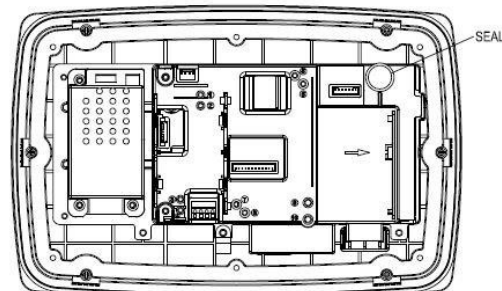

Figure 7-4. TD52XW Paper Seal

8. MAINTENANCE

CAUTION: DISCONNECT THE UNIT FROM THE POWER SUPPLY BEFORE CLEANING.

8.1 Model T52P Cleaning

- The housing may be cleaned with a cloth dampened with a mild detergent if necessary.
- Do not use solvents, chemicals, alcohol, ammonia or abrasives to clean the housing or control panel.

8.2 Model TD52XW Cleaning

- Use approved cleaning solutions for the stainless-steel Indicator housing and rinse with water. Dry thoroughly.
- Do not use solvents, chemicals, alcohol, ammonia or abrasives to clean the control panel.

8.3 Troubleshooting

TABLE 8-1 TROUBLESHOOTING

SYMPTOM	PROBABLE CAUSE (s)	REMEDY
EEP Error	EEPROM Checksum Error	Corrupted EEPROM data
Unit will not turn on.	Power cord not plugged in or properly connected. Power outlet not supplying electricity. Battery discharged (T52P). Other failure.	Check power cord connections. Make sure power cord is plugged in properly into the power outlet. Check power source. Replace batteries (T52P). Service required.
Cannot zero the Scale, or will not zero when turned on.	Load on Scale exceeds allowable limits. Load on Scale is not stable. Load Cell damage.	Remove load on Scale. Wait for load to become stable. Service required.
Unable to calibrate.	Lock Calibration Menu set to On. LFT menu set to On. Incorrect value for calibration mass.	Set Lock Calibration Menu to Off. Refer to Section 3.12 Menu Lock. Set LFT menu to Off. Use correct calibration mass.
Cannot display weight in desired weighing unit.	Unit not set to On.	Enable unit in the Units Menu. Refer to Section 3.7 in the Unit Menu.
Cannot change menu settings.	Menu has been locked.	Set selected menu to Off in the Lock Menu. Lockout Switch on the circuit board may need to be set to the Off position.
Error 8.1	Weight reading exceeds Power On Zero limit.	Remove load from scale. Recalibrate scale.
Error 8.2	Weight reading below Power On Zero limit.	Add load to scale. Recalibrate scale.
Error 8.3	Weight reading exceeds Overload limit.	Reduce load on scale.
Error 8.4	Weight reading below Underload limit.	Add load to scale. Recalibrate scale.
Error 8.6	Weight exceeds six digits. Display overflow.	Reduce load on scale.
Error 8.8	Factory calibration data in memory module at the end of the load cell cable is not valid under LFT OFF status.	Calibrate scale.
Error 8.9	Fail to read serial number from memory module or serial number does not match the indicator's under LFT ON status.	Break the seal or replace the original base/indicator.
Error 9.5	Calibration data not present.	Calibrate scale.
Battery symbol flashing	Batteries are discharged.	Replace batteries (T52P).

CAL E	Calibration value outside allowable limits	Use correct calibration weight.
NO.SW	Attempting to exit the menu with the LFT setting ON and the security switch OFF.	Refer to Section 6.1. Set the security switch to the ON position.
REF WT Err	Reference Weight too small. The weight on the platform is too small to define a valid reference weight.	Use a greater weight for sample.

8.4 Service Information

If the troubleshooting section does not resolve your problem, contact an authorized OHAUS Service Agent. For Service assistance in the United States, call toll-free 1-800-526-0659 between 8:00 AM and 5:00 PM Eastern Standard Time. An OHAUS Product Service Specialist will be available to assist you. Outside the USA, please visit our website www.ohaus.com to locate the OHAUS office nearest you.

9. TECHNICAL DATA

9.1 Specifications

Materials

TD52XW Housing: stainless-steel

TD52P Housing: ABS plastic

Display window: polycarbonate

Keypad: polyester

Ambient conditions

The technical data is valid under the following ambient conditions:

Ambient temperature: -10°C to 40°C / 14°F to 104°F

Relative humidity: Maximum relative humidity 80% for temperatures up to 31°C decreasing linearly to 50% relative humidity at 40°C.

Altitude: up to 2000m

Operability is assured at ambient temperatures between -10°C and 40°C.

TABLE 9-1 SPECIFICATIONS

Indicator Model	TD52P	TD52XW
Maximum displayed resolution	1:75,000	
Maximum approved resolution	1:10,000	
Maximum counting resolution	1:1,500,000	
Weighing units	Kilogram, Gram, Pound, Ounce, Pound: Ounce, Tonne (Metric Tonne), Ton (Short Ton), Custom	
Weighing modes	Basic weighing, Percent weighing, Piece Counting with Optimized APW, Animal weighing/Dynamic weighing, Check weighing	
Display	Dot matrix LCD	
Backlight	White	
Controls	23 button membrane switch	
Ingress protection	---	IP68
Load cell excitation voltage	5 VDC	
Load cell drive	Up to 8 x 350 ohm load cells	
Load cell input sensitivity	Up to 3 mV/V	
Stabilization time	Within 2 seconds	
Auto zero tracking	Off, 0.5 d, 1 d or 3 d	
Zeroing range	2% or 100% of capacity	
Span calibration	1 kg or 1 lb to capacity	
Housing dimensions (W x D x H)	320 X260 X80 mm 12.6 x 10.2 x 3.1 inch	
Net weight	1.5 kg	2 kg
	3.3 lb	4.4 lb
Shipping weight	2 kg	2.5 kg
	4.4 lb	5.5 lb
Operating temperature range	-10 °C to 40 °C	
	14 °F to 104 °F	
Mains power	100-240 VAC / 50-60 Hz internal power supply	
Overvoltage category	II	I
Pollution degree	2	
Battery power	Rechargeable battery pack (option)	
Interfaces	RS232 (standard)	

9.2 Accessories and Options

TABLE 9-2 OPTIONS

P/N	Description
30412537	Interface, WiFi/BT Dongle, OHAUS
30424403	Interface, Analog output
30424404	Interface, RS232/RS485/USB
30424405	Rechargeable Li-ion Battery Kit
30424406	Interface, USB Host
30424021	Light Tower Kit, 3 Colors, OHAUS
30424022	In-use-cover Kit, TD52P
30424023	In-use-cover Kit, TD52XW
30424026	Wall Mount Kit, SST
30424027	Wall Mount Kit, CS
30424409	Extension cable, 9m, TD52
30379716	Cable Gland Kit, M16
30303533	Micro SD Card, 8 G
30097591	Discrete I/O Kit, 2-In/4-Out
30429666	Ethernet Kit



The Rechargeable Battery Kit, RS232 Kit, RS422/485 Kit, Discrete I/O Kit and Analog Output Kit must be installed by a qualified technician.

9.3 Drawings and Dimensions

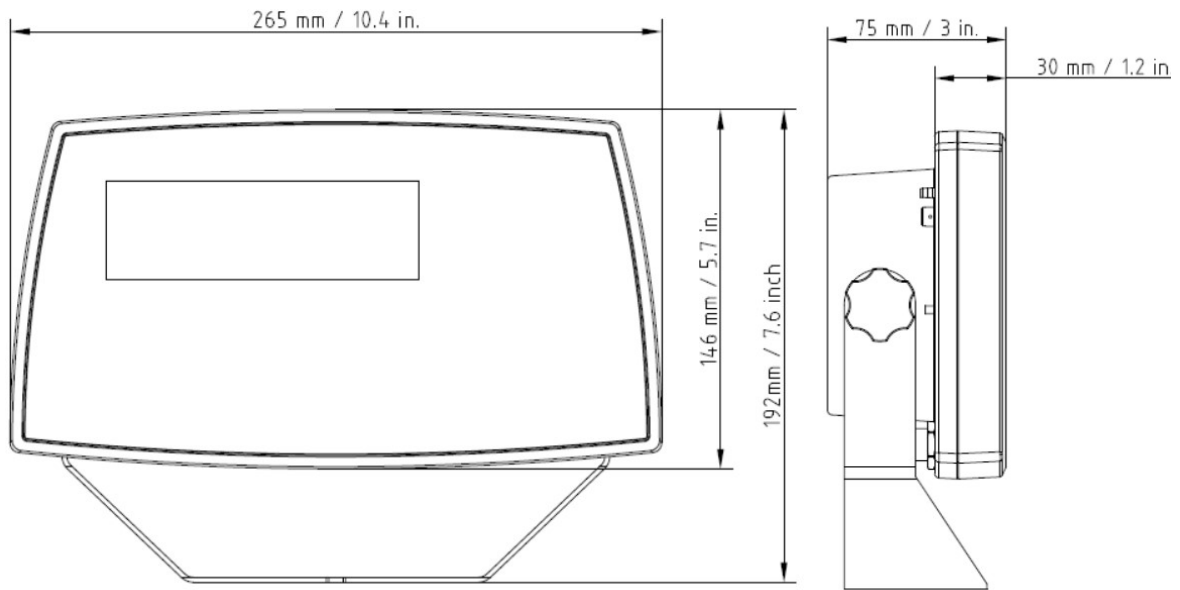

TD52P

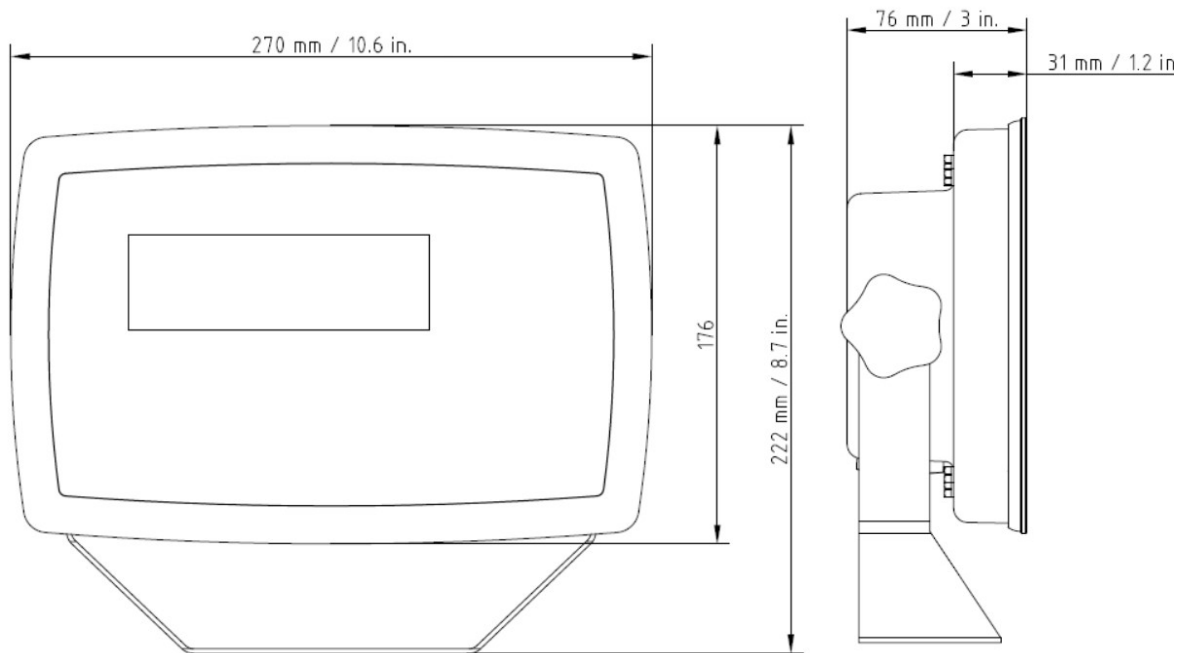

TD52XW



9.4 Table of Geo Values

TABLE 9-4 GEO CODES

		Elevation in meters										
		0	325	650	975	1300	1625	1950	2275	2600	2925	3250
		325	650	975	1300	1625	1950	2275	2600	2925	3250	3575
		Elevation in feet										
		0	1060	2130	3200	4260	5330	6400	7460	8530	9600	10660
		1060	2130	3200	4260	5330	6400	7460	8530	9600	10660	11730
Latitude		GEO value										
0°00'	5°46'	5	4	4	3	3	2	2	1	1	0	0
5°46'	9°52'	5	5	4	4	3	3	2	2	1	1	0
9°52'	12°44'	6	5	5	4	4	3	3	2	2	1	1
12°44'	15°06'	6	6	5	5	4	4	3	3	2	2	1
15°06'	17°10'	7	6	6	5	5	4	4	3	3	2	2
17°10'	19°02'	7	7	6	6	5	5	4	4	3	3	2
19°02'	20°45'	8	7	7	6	6	5	5	4	4	3	3
20°45'	22°22'	8	8	7	7	6	6	5	5	4	4	3
22°22'	23°54'	9	8	8	7	7	6	6	5	5	4	4
23°54'	25°21'	9	9	8	8	7	7	6	6	5	5	4
25°21'	26°45'	10	9	9	8	8	7	7	6	6	5	5
26°45'	28°06'	10	10	9	9	8	8	7	7	6	6	5
28°06'	29°25'	11	10	10	9	9	8	8	7	7	6	6
29°25'	30°41'	11	11	10	10	9	9	8	8	7	7	6
30°41'	31°56'	12	11	11	10	10	9	9	8	8	7	7
31°56'	33°09'	12	12	11	11	10	10	9	9	8	8	7
33°09'	34°21'	13	12	12	11	11	10	10	9	9	8	8
34°21'	35°31'	13	13	12	12	11	11	10	10	9	9	8
35°31'	36°41'	14	13	13	12	12	11	11	10	10	9	9
36°41'	37°50'	14	14	13	13	12	12	11	11	10	10	9
37°50'	38°58'	15	14	14	13	13	12	12	11	11	10	10
38°58'	40°05'	15	15	14	14	13	13	12	12	11	11	10
40°05'	41°12'	16	15	15	14	14	13	13	12	12	11	11
41°12'	42°19'	16	16	15	15	14	14	13	13	12	12	11
42°19'	43°26'	17	16	16	15	15	14	14	13	13	12	12
43°26'	44°32'	17	17	16	16	15	15	14	14	13	13	12
44°32'	45°38'	18	17	17	16	16	15	15	14	14	13	13
45°38'	46°45'	18	18	17	17	16	16	15	15	14	14	13
46°45'	47°51'	19	18	18	17	17	16	16	15	15	14	14
47°51'	48°58'	19	19	18	18	17	17	16	16	15	15	14
48°58'	50°06'	20	19	19	18	18	17	17	16	16	15	15
50°06'	51°13'	20	20	19	19	18	18	17	17	16	16	15
51°13'	52°22'	21	20	20	19	19	18	18	17	17	16	16
52°22'	53°31'	21	21	20	20	19	19	18	18	17	17	16
53°31'	54°41'	22	21	21	20	20	19	19	18	18	17	17
54°41'	55°52'	22	22	21	21	20	20	19	19	18	18	17
55°52'	57°04'	23	22	22	21	21	20	20	19	19	18	18
57°04'	58°17'	23	23	22	22	21	21	20	20	19	19	18
58°17'	59°32'	24	23	23	22	22	21	21	20	20	19	19
59°32'	60°49'	24	24	23	23	22	22	21	21	20	20	19
60°49'	62°90'	25	24	24	23	23	22	22	21	21	20	20
62°90'	63°30'	25	25	24	24	23	23	22	22	21	21	20
63°30'	64°55'	26	25	25	24	24	23	23	22	22	21	21
64°55'	66°24'	26	26	25	25	24	24	23	23	22	22	21
66°24'	67°57'	27	26	26	25	25	24	24	23	23	22	22
67°57'	69°35'	27	27	26	26	25	25	24	24	23	23	22
69°35'	71°21'	28	27	27	26	26	25	25	24	24	23	23
71°21'	73°16'	28	28	27	27	26	26	25	25	24	24	23
73°16'	75°24'	29	28	28	27	27	26	26	25	25	24	24
75°24'	77°52'	29	29	28	28	27	27	26	26	25	25	24
77°52'	80°56'	30	29	29	28	28	27	27	26	26	25	25
80°56'	85°45'	30	30	29	29	28	28	27	27	26	26	25
85°45'	90°00'	31	30	30	29	29	28	28	27	27	26	26

10. COMPLIANCE

Compliance to the following standards is indicated by the corresponding mark on the product.

Mark	Standard
	This product complies with the applicable harmonized standards of EU Directives 2011/65/EU (RoHS), 2014/30/EU (EMC), 2014/35/EU (LVD) and 2014/31/EU (NAWI). The EU Declaration of Conformity is available online at www.ohaus.com/ce .
	EN 61326-1; AS/NZS 61010-1
	UL Std. No. 61010-1 CAN/CSA-C22.2 No. 61010-1

Important notice for verified weighing instruments in the EU

When the instrument is used in trade or a legally controlled application it must be set up, verified and sealed in accordance with local weights and measures regulations. It is the responsibility of the purchaser to ensure that all pertinent legal requirements are met.

Weighing Instruments verified at the place of manufacture bear the following supplementary metrology marking on the descriptive plate.

  1259

Weighing Instruments to be verified in two stages have no supplementary metrology marking on the descriptive plate. The second stage of conformity assessment must be carried out by the applicable weights and measures authorities.

If national regulations limit the validity period of the verification, the user of the weighing instrument must strictly observe the re-verification period and inform the weights and measures authorities

As verification requirements vary by jurisdiction, the purchaser should contact their local weights and measures office if they are not familiar with the requirements.

FCC Note

This equipment has been tested and found to comply with the limits for a Class A digital device, pursuant to Part 15 of the FCC Rules. These limits are designed to provide reasonable protection against harmful interference when the equipment is operated in a commercial environment. This equipment generates, uses, and can radiate radio frequency energy and, if not installed and used in accordance with the instruction manual, may cause harmful interference to radio communications. Operation of this equipment in a residential area is likely to cause harmful interference in which case the user will be required to correct the interference at his own expense.

Industry Canada Note

This Class A digital apparatus complies with Canadian ICES-003

ISO 9001 Registration

The management system governing the production of this product is ISO 9001 certified.

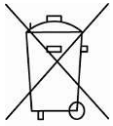
Disposal

In conformance with the European Directive 2012/19/EU on Waste Electrical and Electronic Equipment (WEEE) this device may not be disposed of in domestic waste. This also applies to countries outside the EU, per their specific requirements.

The Batteries Directive 2013/56/EU introduces new requirements from September 2008 on removability of batteries from waste equipment in EU Member States. To comply with this Directive, this device has been designed for safe removal of the batteries at end-of-life by a waste treatment facility.

Please dispose of this product in accordance with local regulations at the collecting point specified for electrical and electronic equipment.

If you have any questions, please contact the responsible authority or the distributor from which you purchased this device.

Should this device be passed on to other parties (for private or professional use), the content of this regulation must also be related.

Disposal instructions in Europe are available online at www.ohaus.com/weee.

Thank you for your contribution to environmental protection.

11. APPENDICES

11.1 Appendix A

MT Standard Continuous Output

A checksum character can be enabled or disabled with continuous output. The data consists of 17 or 18 bytes as shown in the standard continuous output.

Table 5-1.

Non-significant weight data and tare data digits are transmitted as spaces. The continuous output mode provides compatibility with OHAUS products that require real-time weight data. the standard continuous output.

Table 5-1 shows the format for the standard continuous output.

Table 5-1: Standard Continuous Output Format

	Status ²			Indicated Weight ³						Tare Weight ⁴								
Character	1	2	3	4	5	6	7	8	9	10	11	12	13	14	15	16	17	18
Data	STX ¹	SB-A	SB-B	SB-C	MSD	-	-	-	-	LSD	MSD	-	-	-	-	LSD	CR ⁵	CHK ⁶

Continuous Output Format Notes:

1. ASCII Start of Text character (02 hex), always transmitted.
2. Status bytes A, B and C. Refer to Table 5-2, Table 5-3, and Table 5-4 for details of the structure.
3. Displayed weight. Either gross or net weight. Six digits, no decimal point or sign. Insignificant leading zeroes are replaced with spaces.
4. Tare weight. Six digits of tare weight data. No decimal point in field.
5. ASCII Carriage Return <CR> character (0D hex).
6. Checksum, transmitted only if enabled in setup. Checksum is used to detect errors in the transmission of data. Checksum is defined as the 2's complement of the seven low order bits of the binary sum of all characters preceding the checksum character, including the <STX> and <CR> characters.

Table 5-2, Table 5-3, and Table 5-4 detail the status bytes for standard continuous output.

Table 5-2: Status Byte A Bit Definitions

Bits 2, 1, and 0			
2	1	0	Decimal Point Location
0	0	0	XXXXX00
0	0	1	XXXXX0
0	1	0	XXXXXX
0	1	1	XXXXX.X
1	0	0	XXXX.XX
1	0	1	XXX.XXX
1	1	0	XX.XXXX
1	1	1	X.XXXXX
Bits 4 and 3			
4		3	Build Code
0		1	X1
1		0	X2
1		1	X5
Bit 5			Always = 1
Bit 6			Always = 0

Table 5-3: Status Byte B Bit Definitions

Status Bits	Function
Bit 0	Gross = 0, Net = 1
Bit 1	Sign, Positive = 0, Negative = 1
Bit 2	Out of Range = 1 (Over capacity or Under Zero)
Bit 3	Motion = 1, Stable = 0
Bit 4	lb = 0, kg = 1 (see also Status Byte C, bits 0, 1, 2)
Bit 5	Always = 1
Bit 6	Zero Not Captured after power-up = 1

Table 5-4: Status Byte C Bit Definitions

Bits 2, 1, and 0			Weight Description
2	1	0	
0	0	0	lb or kg, selected by Status Byte B, bit 4
0	0	1	grams (g)
0	1	0	metric tons (t)
0	1	1	ounces (oz)
1	0	0	not used
1	0	1	not used
1	1	1	tons (ton)
1	1	1	no units
Bit 3			Print Request = 1
Bit 4			Expand Data x 10 = 1, Normal = 0
Bit 5			Always = 1
Bit 6			Always = 0

11.2 Appendix B

MT-SICS Commands

	Command	Function
LEVEL 0	@	Reset the scale
	I0	Inquiry of all available SICS commands
	I1	Inquiry of SICS level and SICS versions
	I2	Inquiry of scale data
	I3	Inquiry of scale software version
	I4	Inquiry of serial number
	S	Send stable weight value
	SI	Send weight value immediately
	SIR	Send weight value repeatedly
	Z	Zero the scale
	ZI	Zero immediately
LEVEL 1	D	Write text into display
	DW	Weight display
	SR	Send and repeat stable weight value
	T	Tare
	TA	Tare value
	TAC	Clear tare
	TI	Tare immediately

	Command	Function
LEVEL 2	C2	Calibrate with the external calibration weight
	C3	Calibrate with the internal calibration weight
	I10	Inquire or set scale ID
	I11	Inquire of scale type
	P100	Print out on the printer
	P101	Print out stable weight value
	P102	Print out current weight value immediately
	SIRU	Send weight value in the current unit immediately and repeat
	SIU	Send weight value in the current unit immediately
	SNR	Send stable weight value and repeat after every weight change
	SNRU	Send stable weight value in the current unit and repeat after every weight change
	SRU	Send weight value in the current unit and repeat
	ST	After pressing the Transfer key, send the stable weight value
	SU	Send stable weight value in the current unit
LEVEL 3	M01	Weighing mode
	M02	Stability setting
	M03	Autozero function
	M19	Send calibration weight
	M21	Inquire/set weight unit
	PRN	Print out at every printer interface
	RST	Restart
	SFIR	Send weight value immediately and repeat quickly
	SIH	Send weight value immediately in high resolution
	SWU	Switch weight unit
	SX	Send stable data record
	SXI	Send data record immediately
	SXIR	Send data record immediately and repeat
U	Switch weight unit	

LIMITED WARRANTY

OHAUS products are warranted against defects in materials and workmanship from the date of delivery through the duration of the warranty period. During the warranty period OHAUS will repair, or, at its option, replace any component(s) that proves to be defective at no charge, provided that the product is returned, freight prepaid, to OHAUS.

This warranty does not apply if the product has been damaged by accident or misuse, exposed to radioactive or corrosive materials, has foreign material penetrating to the inside of the product, or as a result of service or modification by other than OHAUS. In lieu of a properly returned warranty registration card, the warranty period shall begin on the date of shipment to the authorized dealer. No other express or implied warranty is given by OHAUS Corporation. OHAUS Corporation shall not be liable for any consequential damages.

As warranty legislation differs from state to state and country to country, please contact OHAUS or your local OHAUS dealer for further details.

ÍNDICE

1. INTRODUCCIÓN	5
1.1 Precauciones de seguridad.....	5
1.1.1 Precauciones de seguridad para la opción de relé.....	5
1.2 Descripción de las piezas y controles	6
1.3 Funciones de control	9
2. INSTALACIÓN.....	10
2.1 Desembalaje.....	10
2.2 Conexiones externas	10
2.2.1 Base de báscula con conector	10
2.2.2 Cable de interfaz RS232 para TD52P	10
2.2.3 Corriente eléctrica a TD52P	10
2.2.4 Corriente eléctrica a TD52XW.....	10
2.2.5 Alimentación de pila.....	10
2.3 Conexiones internas	11
2.3.1 Apertura de la carcasa	11
2.3.2 Base de la báscula sin conector	11
2.3.3 Cable de interfaz RS232 para TD52XW.....	13
2.3.4 Instalación de la tarjeta MICRO SD	14
2.4 Orientación de la carcasa posterior de TD52XW	14
2.5 Soporte de montaje.....	14
3. CONFIGURACIÓN	15
3.1 Estructura del menú.....	15
3.2 Menú de navegación	18
3.3 Calibration menu (Menú de calibración)	18
3.3.1 Zero Calibration (Calibración a cero)	18
3.3.2 Span Calibration (Calibración de span).....	19
3.3.3 Linearity Calibration (Calibración de linealidad)	20
3.3.4 GEO Adjustment (Ajuste geográfico)	21
3.4 Setup menu (Menú de configuración)	22
3.4.1 Capacity Unit (Unidades de capacidad)	22
3.4.2 Range (Rango)	22
3.4.3 Capacity (Capacidad)	22
3.4.4 Graduation (Graduación)	23
3.4.5 Language (Idioma).....	23
3.4.6 Power On Zero (Encendido en cero).....	23
3.4.7 Power On Zero (Unidad de encendido)	23
3.4.8 Key Beep (Sonido del teclado).....	24

3.4.9 Transaction Counter (Contador de transacciones).....	24
3.4.10 Tipo E/S.....	24
3.4.11 Reset (Restablecer)	24
3.5 Readout Menu (Menú de lectura).....	24
3.5.1 Stability (Estabilidad)	25
3.5.2 Zero Range (Rango cero).....	25
3.5.3 Filter Level (Nivel de filtrado)	25
3.5.4 Auto Zero Tracking (Cero automático).....	25
3.5.5 Auto Dim (Oscurecimiento automático).....	25
3.5.6 ScreenSaver (Salvapantallas).....	25
3.5.7 Auto Off (Apagado automático)	25
3.5.8 Adjust Contrast (Ajuste de contraste).....	26
3.5.9 Reset (Restablecer)	26
3.6 Discrete I/O (E/S discreta)	26
3.7 Weighing Unit (Unidad de pesaje)	27
3.7.1 Gramo (g).....	27
3.7.2 kilogramo (kg)	28
3.7.3 Libra (lb).....	28
3.7.4 Onza (oz).....	28
3.7.5 Libra: Onza (lb: oz)	28
3.7.6 Tonelada métrica (Metric Tonne)	28
3.7.7 Tonelada (Short Ton).....	28
3.7.8 Unidad personalizada (c)	28
3.8 GLP/GMP Menu (Menú GMP)	29
3.8.1 Date Format (Formato de fecha)	29
3.8.2 Date (Fecha)	29
3.8.3 Date Format (Formato de fecha)	29
3.8.4 Time (Hora).....	29
3.8.5 Project ID (Id. del proyecto).....	29
3.8.6 Scale ID (Id. De la báscula)	29
3.8.7 Reset (Restablecer)	29
3.9 Communication (Comunicación).....	29
3.9.1 RS232/2nd RS232 Configuration (Configuración RS232 / 2º RS232)	30
3.9.2 Configuración de impresión	31
3.9.3 Configuración de RS485	34
3.9.4 Configuración de Ethernet.....	34
3.9.5 Configuración de Wifi.....	34
3.9.6 Configuración de Bluetooth	34

3.9.7 Configuración de Análoga	34
3.10 Configuración de mantenimiento	34
3.11 Configuración de la tecla de bloqueo	34
4. FUNCIONAMIENTO	35
4.1 Pesaje	35
4.1.1 Configuración de la aplicación.....	35
4.1.2 Tara automática	36
4.1.3 Acumulación.....	36
4.1.4 Id. de entrada.....	37
4.1.5 Configuración de Entrada/Salida (E/S)	37
4.2 Recuento	38
4.2.1 Configurar el peso medio de las piezas (APW)	38
4.2.2 Configuración de la aplicación.....	39
4.2.3 Acumulación.....	40
4.2.4 Configuración de Entrada/Salida (E/S)	40
4.3 Check (Comprobar)	41
4.3.1 Comprobación de peso (predeterminado)	41
4.3.2 Comprobación de recuento	42
4.3.3 Configuración de la aplicación.....	43
4.3.4 Configuración de Entrada/Salida (E/S)	44
4.4 Pesaje porcentual	44
4.4.1 Establecer un peso de referencia	45
4.4.2 Configuración de la aplicación.....	45
4.4.3 Configuración de Entrada/Salida (E/S)	46
4.5 Pesaje dinámico.....	47
4.5.1 Configuración de la aplicación.....	47
4.5.2 Configuración de tiempo medio	49
4.5.3 Configuración de Entrada/Salida (E/S)	50
4.6 Llenado	51
4.6.1 Establecimiento de los pesos objetivo	51
4.6.2 Configuración de la aplicación.....	51
4.6.3 Configuración de Entrada/Salida (E/S)	53
5. COMUNICACIÓN SERIAL	54
5.1 Comandos de la interfaz.....	54
5.2 Interfaz RS232.....	55
5.3 Conectar a un ordenador.....	55
5.4 Conectar a una impresora de serie	55
5.5 Impresiones	55

5.6 Ejemplos de impresión	56
6. TARJETA MICRO SD/USB	57
6.1 Biblioteca	57
6.2 Usuario	60
6.3 Alibi	63
6.4 Editable	64
7. LEGAL PARA COMERCIO	65
7.1 Configuración	65
7.2 Comprobación	65
7.3 Sellado	65
8. MANTENIMIENTO	66
8.1 Limpieza del modelo T52P	66
8.2 Limpieza del modelo TD52XW	66
8.3 Solución de problemas	66
8.4 Información de servicio	67
9. DATOS TÉCNICOS	67
9.1 Especificaciones	67
9.2 Accesorios y opciones	69
9.3 Esquemas y dimensiones	70
9.4 Tabla de valores Geo	71
10. CONFORMIDAD	72
11. ANEXOS	74
11.1 Anexo A	74
11.2 Anexo B	76

1. INTRODUCCIÓN

Este manual contiene instrucciones de instalación, funcionamiento y mantenimiento de los Indicadores TD52P y TD52XW. Lea completamente este manual antes de la instalación y funcionamiento.

1.1 Precauciones de seguridad



Para una operación segura y confiable de este dispositivo, respete las siguientes precauciones:

- Compruebe que el voltaje de entrada impreso en la etiqueta de datos coincide con la alimentación de CA local que va a utilizar.
- Asegúrese de que el cable de alimentación no represente un posible obstáculo o riesgo de tropezarse.
- Utilice accesorios y periféricos aprobados.
- Opere la unidad solamente bajo las condiciones ambientales especificadas en estas instrucciones.
- Desconecte el equipo de la fuente de alimentación durante su limpieza.
- No utilice la unidad en entornos peligrosos o en lugares inestables.
- No sumerja el equipo en agua u otros líquidos.
- Cualquier reparación y servicio debe ser realizado solo por personal autorizado.
- El TD52XW se suministra con un cable eléctrico con toma de tierra. Use solamente con una toma de tierra compatible.

1.1.1 Precauciones de seguridad para la opción de relé

Este equipo puede tener una tarjeta de E / S Discreta opcional instalada. Esta opción permite controlar los dispositivos externos mediante el Indicador.



PRECAUCIÓN: RIESGO DE DESCARGA ELÉCTRICA. ELIMINE TODAS LAS FUENTES DE ENERGÍA AL INDICADOR ANTES DE REPARARLO O REALIZAR CONEXIONES INTERNAS. LA APERTURA DE LA CARCASA DEBE REALIZARSE SOLAMENTE POR PERSONAL AUTORIZADO, TAL COMO UN TÉCNICO ELECTRICISTA.

Antes de hacer las conexiones a los terminales del relé, corte la energía del sistema. Si el dispositivo contiene un sistema opcional de pilas recargables, asegúrese de utilizar el botón **ON/CLR Off** se para apagar completamente el sistema después de quitar el enchufe de corriente alterna.

Con el kit de E/S adquirido en el momento de la compra se incluyen instrucciones más detalladas.

1.2 Descripción de las piezas y controles



TABLA 1-1 PIEZAS DEL TD52P

Pieza	Descripción
1	Etiqueta de datos
2	Carcasa frontal
3	Panel de control
4	Soporte de montaje
5	Tornillo (4)
6	Perilla de ajuste (2)
7	Tornillo de seguridad
8	Cubierta de accesorios
9	Carcasa posterior
10	Conectores de energía eléctrica
11	Conector RS232
12	Conectores de la celda de carga

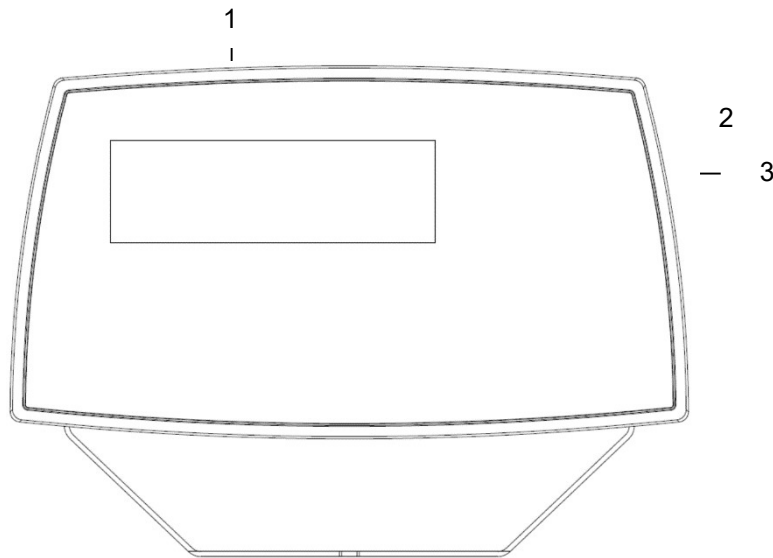
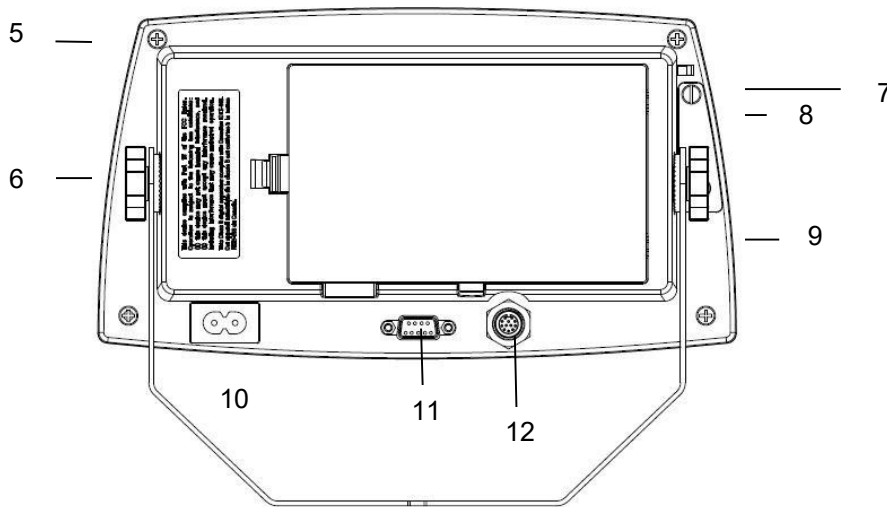

Figura 1-1 Indicador TD52P