

GE Healthcare

See back cover for
quick reference
protocol
card

illustra
blood genomicPrep
Mini Spin Kit

For the rapid extraction and purification of genomic DNA
from small volumes of whole blood and its cell fractions

Product booklet

Codes: 28-9042-64 (50 purifications)
28-9042-65 (250 purifications)



Page finder

1. Legal	3
2. Handling	4
2.1. Safety warnings and precautions	4
2.2. Storage	5
2.3. Expiry	5
3. Components	6
3.1. Kit contents	6
3.2. Materials to be supplied by user	7
3.3. Equipment needed	7
4. Description	8
4.1. Introduction	8
4.2. The basic principle	9
4.3. Product specifications	11
4.4. Typical output	12
5. Protocol	13
5.1. Preparation of working solutions	14
5.2. Sample collection	14
5.3. Protocol for purification of genomic DNA from 50–300 µl whole blood and its cell fractions	15
5.4. Protocol for purification of genomic DNA from 300–1 000 µl whole blood and its cell fractions	19
5.5. Storage of purified genomic DNA	24
6. Appendices	25
6.1. RPM calculation from RCF	25
6.2. Blood source sample input, anticoagulant and cell number	25
6.3. Lysis requirements	29
6.4. Elution requirements	29
6.5. Genomic DNA quantitation	30
6.6. Troubleshooting guide	31
6.7. Related products	34
7. References	36



Quick Reference Protocol Card

Back Cover

**Tear off sheet containing a protocol for the
experienced user extracting genomic DNA from blood**

1. Legal

Product use restriction

The components of the **illustra™ blood genomicPrep Mini Spin Kit** have been designed, developed, and sold **for research purposes only**. They are suitable **for *in vitro* use only**. No claim or representation is intended for its use to identify any specific organism or for clinical use (diagnostic, prognostic, therapeutic, or blood banking).

It is the responsibility of the user to verify the use of the **illustra blood genomicPrep Mini Spin Kit** for a specific application as the performance characteristic of this kit has not been verified to any specific organism.

GE, imagination at work and GE monogram are trademarks of General Electric Company

illustra, PuReTaq, FideliTaq, MegaBACE, Ready-To-Go and DYEnamic are trademarks of GE Healthcare companies.

ExoSAP-IT is a registered trademark of USB corp.

All third party trademarks are the property of their respective owners.

© 2006–2007 General Electric Company – All rights reserved.
Previously published 2006. Date of revision Apr. 2007.

All goods and services are sold subject to the terms and conditions of sale of the company within GE Healthcare which supplies them. A copy of these terms and conditions is available upon request.

Contact your GE representative for the most current information (see back cover for contact details).

<http://www.gelifesciences.com>

GE Healthcare UK Limited.

Amersham Place, Little Chalfont,
Buckinghamshire. HP7 9NA UK.

2. Handling

2.1. Safety warnings and precautions

Warning: For research use only.

Not recommended or intended for diagnosis of disease in humans or animals. Do not use internally or externally in humans or animals.

All chemicals should be considered as potentially hazardous. Only persons trained in laboratory techniques and familiar with the principles of good laboratory practice should handle these products. Suitable protective clothing such as laboratory overalls, safety glasses, and gloves should be worn. Care should be taken to avoid contact with skin or eyes; if contact should occur, wash immediately with water (see Material Safety Data Sheet and/or Safety Statement(s) for specific recommendations).

Warning: This protocol requires the use of Ethanol.

The chaotrope in Lysis buffer type 10 is harmful if ingested, inhaled, or absorbed through the skin, and can cause nervous system disturbances, severe irritation, and burning. High concentrations are extremely destructive to the eyes, skin, and mucous membranes of the upper respiratory tract. Gloves should always be worn when handling this solution.

Use of this product with blood and blood products should be considered bio-hazardous. Follow appropriate safety procedures while using this kit and when handling DNA isolated from blood.

Waste effluents from this kit should be decontaminated with bleach or a detergent-based method. Decontamination with bleach may be reactive, resulting in foam and emission of

ammonia gas and should be carried out in an exhaust hood.

Consult local safety regulations for safe disposal of all treated waste.

2.2. Storage

All kit components should be stored at room temperature (20–25°C). Once reconstituted, store Proteinase K at 4°C.







2.3. Expiry

For expiry date please refer to outer packaging label.

Proteinase K reconstituted in DNase-free water is stable for 4 months when stored at 4°C.

3. Components

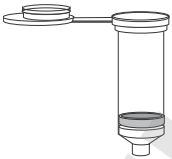
3.1. Kit contents

Identification	Pack Size	10	50	250
Cat. No.		purifications	purifications	purifications
	Sample Pack	28-9042-64	28-9042-65	
	Proteinase K, lyophilized powder (Black colored cap)	1 vial (10 mg)	1 vial (30 mg)	2 vials (2 × 60 mg)
	Lysis buffer type 10 (Red colored cap)	10 ml	50 ml	2 × 125 ml
	Wash buffer type 6 (Yellow colored cap)	1.5 ml (Add 6 ml Absolute Ethanol before use)	6 ml (Add 24 ml Absolute Ethanol before use)	30 ml (Add 120 ml Absolute Ethanol before use)
	Elution buffer type 5 (silver colored cap)	3 ml	12 ml	60 ml
	illustra™ blood mini column	10	50	5 × 50
	Collection tubes	10	50	5 × 50

Refer to the Certificate of Analysis for a complete list of kit components.

GE Healthcare supplies a wide range of buffer types across the illustra nucleic acid purification and amplification range. The composition of each buffer has been optimized for each application and may vary between kits. Care must be taken to only use the buffers supplied in the particular kit you are using and not use the buffers supplied in other illustra kits e.g. the Lysis buffer type 10 supplied in the illustra blood genomicPrep Mini Spin Kit is not the same as the Lysis buffer type 2 supplied in the illustra bacteria genomicPrep Mini Spin Kit.

In order to avoid confusion and the accidental switching of buffers between kits, a numbering system has been adopted that relates to the entire range of buffers available in the illustra purification range. For example there are currently 14 Lysis buffers in the illustra range, 6 Wash buffers and 8 Elution buffers, denoted by Lysis buffer type 1–14, Wash buffer type 1–6 and Elution buffer type 1–8, respectively. Please ensure you use the correct type of Lysis, Wash and Elution buffer for your purification.

3.2. Materials to be supplied by user

Disposables:

1.5 ml DNase-free microcentrifuge tubes

Chemicals:

Absolute Ethanol

DNase-free water

Dulbecco's Phosphate Buffered Saline Solution (PBS) may be required.

For blood samples > 300 µl RBC lysis buffer is required as described in section 5.1. For this buffer KHCO_3 , NH_4Cl and EDTA are needed.

3.3. Equipment needed

Microcentrifuge that accommodates 1.5 ml microcentrifuge tubes

Water bath or heat-block for 70°C incubation

Vortex mixer

4. Description

4.1. Introduction





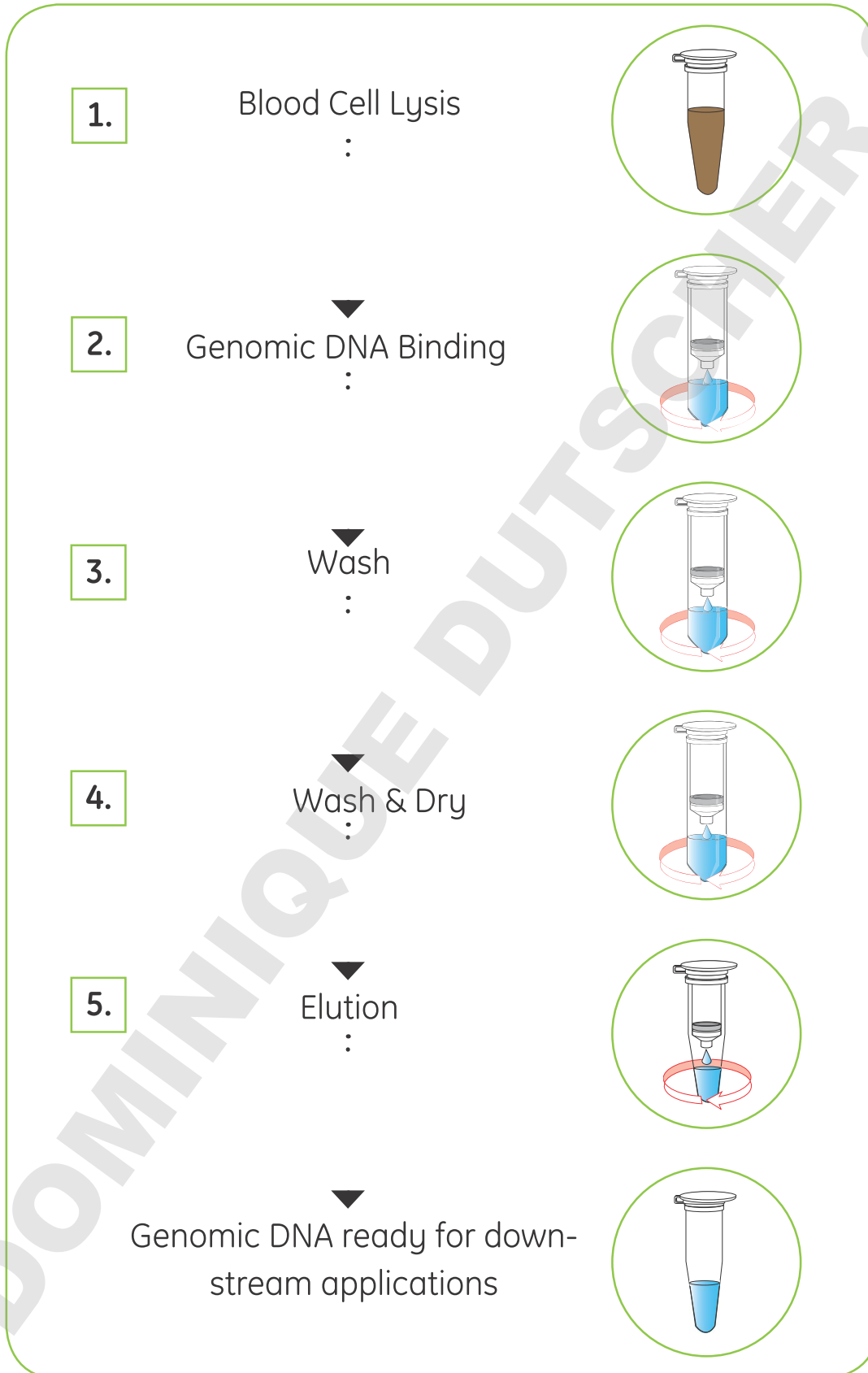

The **illustra™ blood genomicPrep Mini Spin Kit** is designed for the rapid extraction and purification of genomic DNA from whole blood and Buffy coat, bone marrow and nucleated red blood cells. The protocols are rapid and have been designed to minimize shearing, resulting in high quality intact genomic DNA. The kit can process 50–1 000 µl of whole blood. Purified genomic DNA yields are typically between 4–6 µg from 200 µl of whole blood with a purity ratio (A_{260}/A_{280}) greater than 1.7. The procedure can be completed in less than 20 minutes to yield genomic DNA with a purity and quality that is compatible with most molecular biology techniques, including cloning, restriction enzyme digestion, PCR amplification and genotyping applications. The kit contains sufficient reagents and columns for 50 (28-9042-64) and 250 (28-9042-65) purifications.

The developed method uses a chaotropic agent to extract DNA from blood cells, denature protein components and promote the selective binding of DNA to the silica-membrane contained in an illustra blood mini column (1–3). Proteinase K is the protease of choice to digest protein from samples, because it is active even when enzyme inhibitors such as EDTA and detergents are present in samples (4). Denatured contaminants are easily removed by subsequent washing of the silica membrane with an ethanolic buffer. The purified genomic DNA is eluted in a low ionic strength buffer at a concentration suitable for most downstream molecular biology applications.

4.2. The basic principle

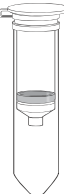
Use of the **illustra blood genomicPrep Mini Spin Kit** involves the following steps:



Step	Comments	Component
1. Blood Cell Lysis	Blood cells are lysed by a chaotropic salt in Lysis buffer type 10, in the presence of Proteinase K	Lysis buffer type 10  Proteinase K 
2. Genomic DNA Binding	The chaotropic salt in Lysis buffer type 10 promotes selective binding of genomic DNA to the silica membrane. Denatured proteins are collected in the flowthrough	illustra blood mini column & Collection tube  Lysis buffer type 10 
3. Wash	Lysis buffer type 10, containing a chaotropic salt, removes protein and other contaminants from membrane-bound genomic DNA	Lysis buffer type 10 
4. Wash & Dry	Wash buffer type 6 containing Ethanol removes residual salts and other contaminants.	Wash buffer type 6 
5. Elution	Genomic DNA is eluted in a low ionic strength buffer	Elution buffer type 5 

4.3. Product specifications

The **illustra blood genomicPrep Mini Spin Kit** is recommended for the isolation of genomic DNA from blood and its cell fractions. The kit can be used to isolate genomic DNA from various sample sources and amounts as indicated below.

Sample Types:	Whole blood, Buffy coat, bone marrow cells & nucleated blood
Sample input volume	50–300 µl whole blood, Buffy coat, bone marrow cells* 2–10 µl nucleated blood† 300–1 000 µl whole blood‡
Elution volume	200 µl
Number of steps	5
Maximum binding capacity	60 µg
Yield	4–6 µg/200 µl whole blood
Purity (A ₂₆₀ /A ₂₈₀)	> 1.7–1.9
Time/prep	less than 20 minutes
Product size	> 20 kbp
Scalability	Up to 1 ml

*For 50–300 µl whole blood, Buffy coat & bone marrow cells and 2–10 µl nucleated blood - follow protocol in section 5.3.

†nucleated blood refers to blood derived from avian species such as chicken.

‡For 300–1 000 µl whole blood - follow protocol in section 5.4.

4.4. Typical output

Figure 1. Gel characteristics of genomic DNA purified from K3 EDTA-treated human whole blood.

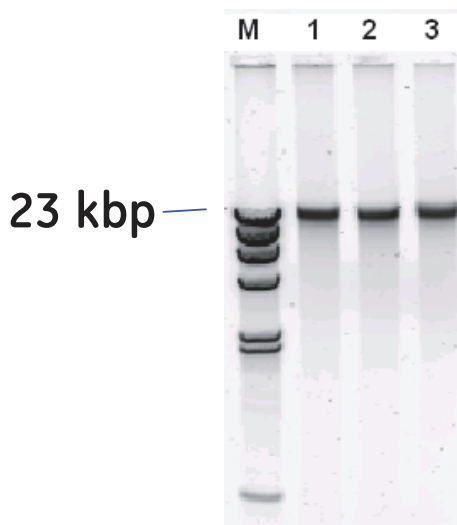

M= Lambda HindIII Marker

1, 2, 3= genomic DNA purified from blood

1% agarose gel loaded with 3 μ l of purified eluates (n = 3).

The **illustra blood genomicPrep Mini Spin Kit** yields 4-6 μ g genomic DNA from 200 μ l of whole blood. The product is of high quality with purity (A_{260}/A_{280}) > 1.7 and 90% product is > 20 kbp. The purified genomic DNA is ready to use for downstream applications like cloning, restriction enzyme digestion, PCR amplification and genotyping.

5. Protocol

Numerous factors can affect the quantity and quality of the isolated genomic DNA from blood. These factors are outlined in detail in appendix 6.

 **Note:** Buffers and mini columns ARE NOT transferable between GE Healthcare illustra kits, e.g., the composition of the Lysis buffer type 10 in the blood genomicPrep Mini Spin Kit is not the same as the Lysis buffer type 2 in the bacteria genomicPrep Mini Spin Kit. Please note buffer type number for differentiation. The blood mini columns are not the same as the columns supplied in the plasmidPrep Mini Spin Kit.

Use of icons

The key below describes the purpose of the icons used throughout the protocol booklet.

 This icon is used to highlight particularly critical steps within the protocol that must be adhered to. If this advice is not followed it will have a detrimental impact on results.

 This icon is used to highlight technical tips that will enhance the description of the step. These tips may indicate areas of flexibility in the protocol or give a recommendation to obtain optimum performance of the kit.

5.1. Preparation of working solutions

See section 3.2. and 3.3. for Materials & Equipment to be supplied by user.

Proteinase K

Dissolve the supplied lyophilized **Proteinase K** in DNase-free water. Add 1.5 ml of DNase-free water to the vial of Proteinase K in kit 28-9042-64 or 3 ml to EACH vial of **Proteinase K** in kit 28-9042-65. Sample pack users, please add 500 µl DNase-free water to the vial

of Proteinase K. Final concentration is 20 mg/ml. Vortex to dissolve. Store the re-dissolved solution at 4°C.

Wash buffer type 6

Prior to use, add Absolute Ethanol to the bottle containing **Wash buffer type 6**. Add 24 ml of Absolute Ethanol to **Wash buffer type 6** in kit 28-9042-64 or add 120 ml to **Wash buffer type 6** in kit 28-9042-65. Mix by inversion. Indicate on the label that this step has been completed.

For 10 purifications sample pack size; please add 6 ml of Absolute Ethanol to Wash buffer type 6 prior to use.

Store upright and air tight at room temperature (20–25°C).

Elution buffer type 5

Heat **Elution buffer type 5** to 70°C in a water bath or a heat-block prior to start of Elution step.

RBC lysis buffer

This buffer is needed only for processing blood and/or blood fractions ranging from 300–1 000 µl using the two-stage lysis method as described in section 5.4.

10 mM KHCO₃

155 mM NH₄Cl

0.1 mM EDTA, pH 8

Filter sterilize using a 0.2 µm filter.

Volume of RBC Lysis buffer required per purification is three times the volume of blood to be processed.

5.2. Sample collection

An anticoagulant, such as heparin, citrate or EDTA, should be used when collecting whole blood, Buffy coat and bone marrow cells. The blood may be stored at 4°C or frozen, but if processing frozen samples completely thaw at room temperature. Whether the sample is fresh, has been stored at 4°C or has been thawed from frozen, ensure complete homogenization of the sample by use of a circular wheel at room temperature for 20–30 minutes.

Follow the protocol in section 5.3 for samples 50–300 μl in volume but if starting sample volume is less than 200 μl , dilute to 200 μl with a physiological buffer such as PBS. When purifying genomic DNA from a sample volume of 300–1000 μl , follow protocol in section 5.4.

5.3. Protocol for purification of genomic DNA from 50–300 μl whole blood and its cell fractions

1. Blood Cell Lysis

a. Add 20 μl of **Proteinase K**  into the bottom of a 1.5 ml microcentrifuge tube.

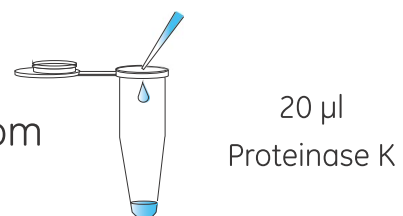

b. Add up to 300 μl of whole blood sample.

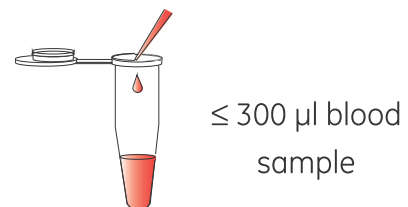

Note: This protocol is suitable for 50–300 μl of whole blood, Buffy coat and bone marrow cells, and 2–10 μl of nucleated blood sample (from avian species such as chicken). Optimal performance is obtained with 200 μl whole blood. When starting volume is less than 200 μl , make input sample volume up to 200 μl with PBS.



Note: RNase-treatment is optional in this protocol. In order to obtain RNA-free product treat the starting sample with RNase A prior to addition of the **Lysis buffer type 10** . A final concentration of 1–2 mg/ml RNase is sufficient to degrade RNA.

RNase A
(optional)

c. Add 400 μ l of **Lysis buffer type 10**  to the tube. Mix well by vortexing for 15 seconds.



400 μ l
Lysis buffer
type 10

d. Incubate the tube at room temperature (RT) for 10 minutes with intermittent vortexing to aid lysis. At the end of this stage the color of the reaction will change from red to dark brown.



10 minutes RT

e. Briefly spin to bring sample to the bottom of the tube.

Pulse

2. Genomic DNA Binding

a. Assemble a mini column in the supplied Collection tube. Use individual columns for individual samples. These columns are for single-use only.

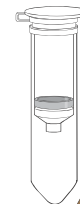

b. Load the complete lysate on to the center of the column using a pipet.

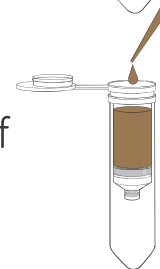

Apply lysate

c. Close the cap of the column and transfer it to a microcentrifuge. Spin the column for 1 minute at 11 000 \times g.

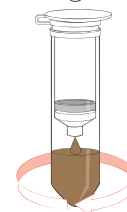

1 minute
11 000 \times g

d. Remove the Collection tube containing the flowthrough carefully without touching the base of the column. Discard the flowthrough.



e. Place the column back inside the Collection tube.

 **Note:** See appendix 6.1. for RPM calculation from RCF.

3. Wash

a. Add 500 μ l of **Lysis buffer type 10**  to the column.

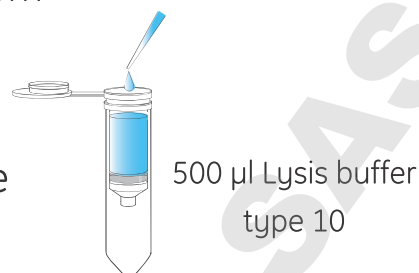

b. Centrifuge for 1 minute at 11 000 \times g. This step ensures complete cell lysis and denatures any residual proteins. Discard flowthrough.

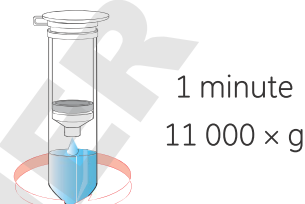

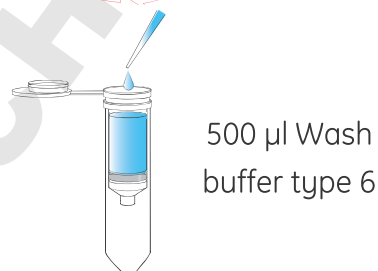

4. Wash & Dry

a. Add 500 μ l of **Wash buffer type 6**  to the column.

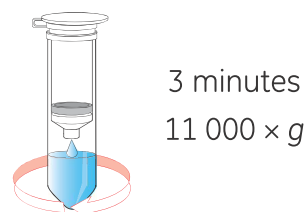

b. Centrifuge for 3 minutes at 11 000 \times g. Discard the Collection tube and flowthrough.





 **Note:** Carefully discard flowthrough and the Collection tube. If any of the ethanolic wash solution comes into contact with the bottom of the column, discard the flowthrough and re-centrifuge for an additional 1 minute. The presence of Ethanol in the eluted genomic DNA may affect many downstream applications. The genomic DNA trapped on the silica matrix is of high purity and now ready for elution.

5. Elution

a. Transfer the purification column into a fresh DNase-free microcentrifuge tube (user supplied).

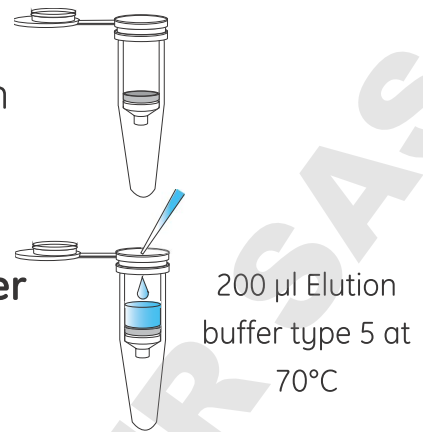
b. Add 200 μ l of 70°C pre-heated **Elution buffer type 5**  directly on to the center of the column.



 **Note:** Pre-heat the **Elution buffer type 5** to 70°C prior to use. The actual volume recovered will be 80–100% of the volume of buffer applied to the column. Change pipet tips between samples if applying Elution buffer type 5 to multiple samples, to reduce variation in volume of sample eluted.

c. Incubate the column for 1 minute at room temperature.



 **Note:** Do not incubate longer than 1 minute to get good quality genomic DNA.

d. Centrifuge for 1 minute at 11 000 \times g to recover the genomic DNA.

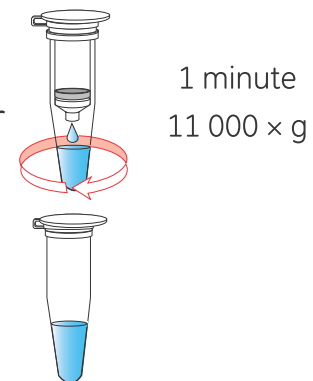

e. Store purified genomic DNA at -20°C. For additional details see section 5.5.

5.4. Protocol for purification of genomic DNA from 300–1 000 μ l whole blood and its cell fractions

To isolate genomic DNA from sample volumes ranging from 300–1000 μ l, we recommend the following protocol for use with this product. This method involves two-stage lysis of blood and its fractions as adapted from Vogelstein et al (5). The first stage involves selective lysis of red blood cells (RBC) while white blood cells (WBC) are pelleted down. In the second stage, nucleated cells are lysed to release DNA that is then purified from the silica-membrane column.

The RBC lysis described below is performed in a larger tube (e.g., 15 ml) and the resulting WBC pellet is transferred to a 1.5 ml microcentrifuge tube for extraction.

1. Blood Cell Lysis

a. Prepare the RBC lysis buffer as described in section 5.1.



Note: Components of RBC lysis buffer are not provided with this kit.

b. Add three times the blood sample volume of RBC lysis buffer to a centrifuge tube (e.g., 15 ml tube). For example, add 3 ml of RBC lysis buffer for 1 ml of blood.

c. Transfer the one volume of whole blood or its cell fractions sample (300 μ l–1 000 μ l) to the RBC lysis buffer. Mix thoroughly by inverting the tube several times.

d. Incubate for 5 minutes at room temperature (RT).



3 volumes RBC lysis buffer



1 volume sample (300–1 000 μ l)

5 minutes RT

e. Centrifuge the RBC lysis mixture at $500 \times g$ for 2 minutes to pellet the WBCs.

f. Discard the supernatant (by decanting or aspiration) without disturbing the WBC pellet. Some residual fluid will remain on the sides of the tube. This residual fluid (approximately $50\text{--}100 \mu\text{l}$) is needed to resuspend the cells before extraction.

g. Add another $100\text{--}150 \mu\text{l}$ of PBS to bring volumes up to $200 \mu\text{l}$ of cell suspension. Resuspend the cell pellet with vigorous vortexing and transfer the resuspended WBCs to a fresh 1.5 ml microcentrifuge tube.

h. Add $20 \mu\text{l}$ of **Proteinase K**  to the resuspended WBCs.

 **Note:** RNase-treatment is optional in this protocol. In order to obtain RNA-free product, treat the starting sample with RNase A prior to addition of the Lysis buffer type 10. A final concentration of about $1\text{--}2 \text{ mg/ml}$ RNase is enough to degrade RNA.

i. Add $400 \mu\text{l}$ of **Lysis buffer type 10**  to the tube. Mix well by vortexing for 15 seconds.

j. Incubate the tube at room temperature for 10 minutes with intermittent vortexing to aid lysis. At the end of this stage the color of the reaction will change from red to dark brown.

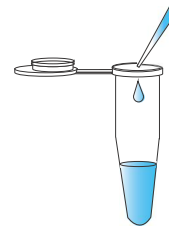
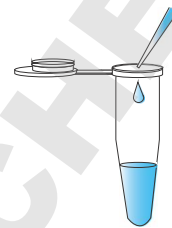
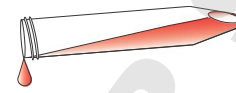
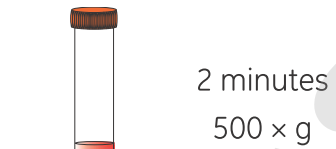

$400 \mu\text{l}$
Lysis buffer
type 10

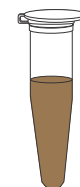

10 minute RT

k. Briefly spin to bring sample to the bottom of the tube.

Pulse

2. Genomic DNA Binding

a. Assemble a mini column in the supplied Collection tube. Use individual columns for individual samples. These columns are for single-use only.

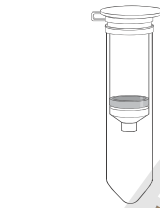

b. Load the complete lysate on to the center of the column using a pipet.

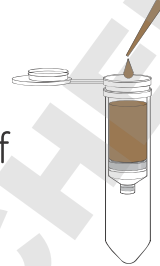

Apply lysate

c. Close the cap of the column and transfer it to a microcentrifuge. Spin the column for 1 minute at $11\,000 \times g$.

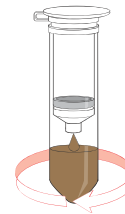

1 minute
 $11\,000 \times g$

d. Remove the Collection tube containing the flowthrough carefully without touching the base of the column. Discard the flowthrough.

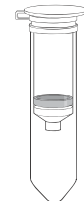

e. Place the column back inside the Collection tube.

 **Note:** See appendix 6.1. for RPM calculation from RCF.

3. Wash

a. Add 500 μ l of **Lysis buffer type 10**  to the column.

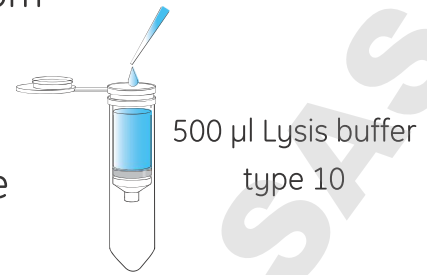

b. Centrifuge for 1 minute at 11 000 \times g. This step ensures complete cell lysis and denatures any residual proteins. Discard flowthrough.

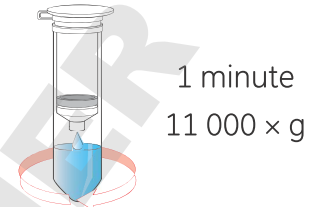

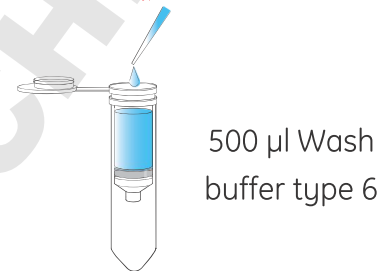

4. Wash & Dry

a. Add 500 μ l of **Wash buffer type 6**  to the column.

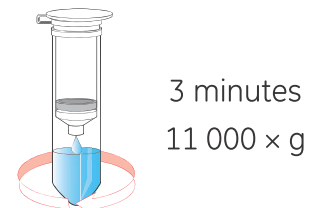

b. Centrifuge for 3 minutes at 11 000 \times g. Discard the Collection tube and flowthrough.





 **Note:** Carefully discard flowthrough and the Collection tube. If any of the ethanolic wash solution comes into contact with the bottom of the column, discard the flowthrough and re-centrifuge for an additional 1 minute. The presence of Ethanol in the eluted genomic DNA may affect many downstream applications. The genomic DNA trapped on the silica matrix is highly pure and now ready for elution.

5. Elution

a. Transfer the purification column into a fresh DNase-free microcentrifuge tube (user supplied).

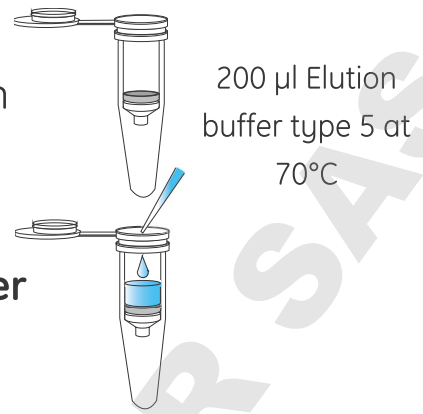
b. Add 200 μl of 70°C pre-heated **Elution buffer type 5**  directly on to the center of the column.



 **Note:** Pre-heat the buffer for elution to 70°C prior to use. The actual volume recovered will be 80–100% of the volume of buffer applied to the column. Change pipet tips between samples if applying **Elution buffer type 5** to multiple samples, to reduce variation in volume of sample eluted.

c. Incubate the column for 1 minute at room temperature.



 **Note:** Do not incubate longer than 1 minute to get good quality genomic DNA.

d. Centrifuge for 1 minute at 11 000 \times g to recover the genomic DNA.

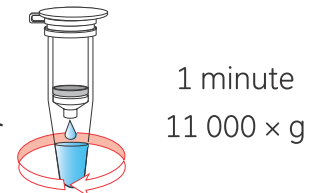

e. Store purified genomic DNA at -20°C. For additional details see section 5.5.



5.5. Storage of purified Genomic DNA

Purified genomic DNA may be stored at 4°C for a short period. In order to maintain a high quality product for repeated use, aliquot and store purified samples at -20°C. The **Elution buffer type 5** provided should be the preferred buffer for eluting samples, although DNase-free water can be used. DNA eluted in water is not recommended for long-term storage since it undergoes acid hydrolysis (6).

DOMINIQUE DUTSCHER

6. Appendices

6.1. RPM calculation from RCF

The appropriate centrifugation speed for a specific rotor can be calculated from the following formula:

$$\text{RPM} = 1\,000 \times \sqrt{(\text{RCF}/1.12r)}$$

Where RCF = relative centrifugal force; r = radius in mm measured from the center of the spindle to the bottom of the rotor bucket; and RPM = revolutions per minute.

E.g. if an RCF of $735 \times g$ is required using a rotor with a radius of 73 mm, the corresponding RPM would be 3 000.

6.2. Blood source, anticoagulant and cell number

Blood source

This kit performs well with whole blood and Buffy coat preparation from humans, horses, rabbits, rats, mice and chickens. Unique differences between species exist in the aggregation tendency of blood (7) and this can affect the efficient lysis and extraction of WBC. Also fresh or frozen blood can be used to isolate genomic DNA. Both yield and purity of the end-product will be determined by the total viable WBC count in the blood samples.

See Table 1 for typical yield and purity of genomic DNA isolated from different species.

Table 1: Comparison of yield (μg) and purity (A_{260}/A_{280}) of isolated genomic DNA from whole blood from different animals

Sample Type (K3-EDTA anticoagulant)	Sample volume (μl)	Yield (μg)	Purity (A_{260}/A_{280})
Human Whole Blood	200	7.4 ± 1.8	1.7 ± 0.04
Horse Whole Blood	200	8.4 ± 1.6	1.7 ± 0.05
Rabbit Whole Blood	200	9.8 ± 1.2	1.9 ± 0.00
Rat Whole Blood	200	12.2 ± 1.8	1.8 ± 0.05
Mouse Whole Blood Cells	200	14.1 ± 3.5	1.9 ± 0.05
Mouse Bone Marrow	200	23.9 ± 2	1.9 ± 0.06
Chicken Nucleated Blood	10	12.4 ± 0.03	1.9 ± 0.03

Whole blood and its cell fraction was collected using K3-EDTA anticoagulant across all animals. Indicated amount of blood was processed using the **illustra blood genomicPrep Mini Spin Kit** protocol with $n=3$. Mean and SD are shown.

Blood sample input range

The kit is designed to process starting sample volumes from 50–300 μl of whole blood using the standard direct lysis method in section 5.3. The purified genomic DNA shows a linear increase in yield obtained in this range. For nucleated blood samples a smaller sample input volume of 2–10 μl is recommended due to the high concentration of nucleated cells. For sample volumes between 300–1 000 μl a modified two-stage lysis has also been developed (section 5.4).

Figure 2: Human whole blood input volume versus yield using the two methods provided

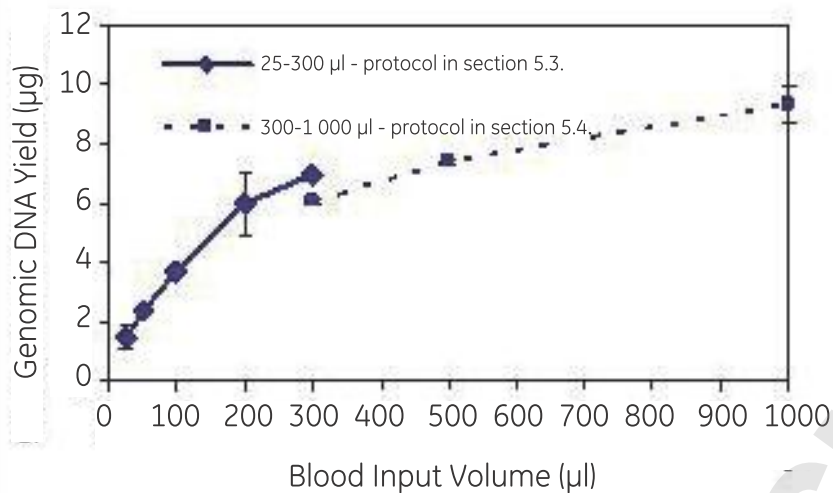

K3-EDTA whole human blood sample from 25–1 000 µl was extracted using the **illustra blood genomicPrep Mini Spin Kit** protocol. Replicates were n=3. Product purity as measured by A_{260}/A_{280} ratio was > 1.7. Mean and SD are plotted.

Methods used were as described in Section 5.3. Protocol for purification of genomic DNA from whole blood and its cell fractions and the two-stage lysis method in Section 5.4. Protocol for purification of genomic DNA from 300–1 000 ul whole blood and its cell fractions.

Anticoagulants

Different anticoagulant-treated whole blood such as heparin, EDTA and citrate have been shown to consistently produce high yield and purity genomic DNA with this kit. The purified product performed well when used in quantitative PCR. No differences were seen in either the change in efficiency of the PCR or the fold amplification (Ct values) compared to genomic DNA isolated by other solution-based methods.

Figure 3: Similar yields of purified genomic DNA isolated from human (Hu) whole blood treated with various anticoagulants

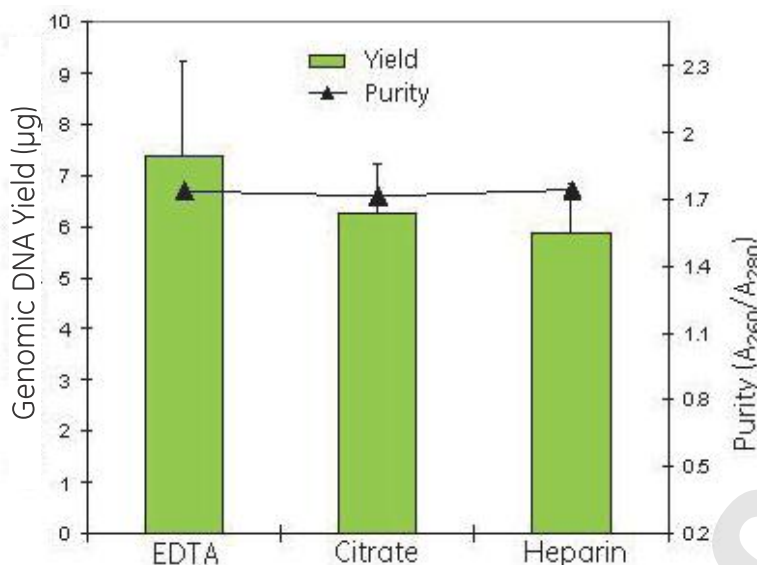

Whole blood was collected from an individual and treated with K3-EDTA, sodium citrate and heparin, and extracted using the illustra blood genomicPrep Mini Spin Kit. Replicates were n=3. Product purity as measured by A_{260}/A_{280} was > 1.7 . Mean and SD are plotted.

Cell numbers

The normal human blood cell count for WBC's is $4\ 500\text{--}11\ 000 \times 10^3$ cells/ml. This corresponds to theoretical yields of 27–66 µg genomic DNA/ml blood (8). For 200 µl of blood the maximal achievable yield is 5.4 to 13.4 ug. The method of collecting blood and the length of storage can influence the viability of the WBCs. The yield of genomic DNA purified using this kit is directly proportional to the quality of the input sample. Higher cell numbers can be obtained by using leukocyte-enriched fractions of whole blood or Buffy coat. Some protocol optimization may be necessary for complete lysis of Buffy coat and for obtaining high purity product.

6.3. Lysis requirements

Cell number and scalability

This kit is designed to purify genomic DNA from 50–300 μl of whole blood and its fractions. The cell count of the starting material will determine the yield and purity of genomic DNA isolated from this kit. We offer a modified two-stage lysis method for samples 300–1 000 μl as described in section 5.4.

Lysis temperature and time

Under the conditions developed with this kit, 200 μl of whole human blood is completely lysed at room temperature within 10 minutes. The efficiency of lysis will change based on the cell count of the sample. The product yields and purity of genomic DNA will depend on the efficiency of the lysis reaction.

Reagent and sample addition order

Order of addition of Proteinase K, blood and Lysis buffer type 10 shows no significant effect on yield or purity of the end product as long as samples are well homogenized.

RNAase-treatment

If RNA-free samples are required, carry out the RNase-treatment during the Blood Cell Lysis step as suggested in sections 5.3 and 5.4.

6.4. Elution requirements

Elution temperature and time

Use Elution buffer type 5 supplied with this kit for maximal recovery. Alternatively, 10 mM Tris-HCl pH 8.0 or autoclaved double-distilled water may be used. Prior to carrying out the Elution step, pre-heat the Elution buffer type 5 or water to 70°C. Heated Elution buffer type 5 will give maximal DNA recovery. Unheated Elution buffer gives reduced product recovery of about 50%.

Elution buffer type 5 is incubated with the silica-membrane for 1 minute at room temperature prior to collecting the purified product. Increasing this incubation time has marginal improvements in yield, but may deteriorate the purity of the collected product.

Successive elution

A single elution step recovers about 70–80% of the purified genomic DNA from the column. Multiple elution steps can increase the yield, but the purity of the product may be lower.

Elution volume recovery

For optimal DNA recovery, use 200 μ l of Elution buffer type 5. Elution volumes of 100 μ l or lower may be used to concentrate the sample, but this will reduce the yield. For example, using 50 μ l instead of 100 μ l will concentrate the DNA approximately 2 \times with a loss in recovery of approximately 20%. The actual volume recovered will be about 80–100% of the volume of elution buffer applied to the column.

Product size

The rapid and gentle protocol provided with this kit isolates genomic DNA from blood and its fractions, with a characteristic band size of greater than 20 kbp. This major band constitutes greater than 90% of the purified product visible on an agarose gel.

6.5. Genomic DNA quantitation

The yield of genomic DNA isolated by use of this kit can be measured by UV absorbance. A typical concentration range is 20–35 ng/ μ l and is ample for many downstream applications. If higher concentrations are required, reduce volume of Elution buffer type 5 used to 50–100 μ l.

6.6. Troubleshooting guide

This guide may be helpful in the first instance, however if problems persist or for further information please contact GE Healthcare technical services. Telephone numbers are on the back page. Alternatively log onto <http://www.gelifesciences.com/illustra>.

Problem: DNA yield is low

Possible cause	Suggestions
<i>Incorrect storage of sample that resulted in degradation of DNA prior to purification.</i>	<ul style="list-style-type: none">• Blood samples should be stored with a preservative to prevent clotting and sample degradation e.g. citrate, heparin or EDTA.• Blood should be stored at 4°C for no more than 2 days. Frozen blood will give slightly lower yields than fresh blood.• DNA isolations using old samples or incorrectly stored samples may not yield any DNA.• DNA yield will ultimately depend on the number of DNA-containing (nucleated) cells in the sample.
<i>Wash buffer type 6 was not completely removed before Elution.</i>	<ul style="list-style-type: none">• Make sure that the illustra blood mini column is centrifuged for at least 3 minutes as described in Wash & Dry step before the Elution buffer type 5 is added. If humidity is high, increase the spin time to 5 minutes.
<i>Proteinase K activity reduced or lost.</i>	<ul style="list-style-type: none">• Proteases are essential to deproteinate the extracted DNA. Reconstituted proteinase K should be stored at 4°C and is stable for up to 4 months.

Problem: A_{260}/A_{280} of product is <1.7

Possible cause	Suggestions
<i>Starting sample was degraded.</i>	<ul style="list-style-type: none">• Blood and its fractions can get degraded if stored incorrectly for an extended period of time. Store blood at 4°C to reduce degradation of proteins and use within 2 days.
<i>Wash and/or Wash & Dry step was incomplete.</i>	<ul style="list-style-type: none">• Repeat the Wash and/or Wash & Dry step to improve purity values as described.
<i>Proteinase K activity reduced or lost</i>	<ul style="list-style-type: none">• Proteases are essential to deproteinate the extracted DNA. Reconstituted proteinase K should be stored at 4°C and is stable for up to 4 months.

Problem: Purified genomic DNA floats out of the well when loading a gel

Possible cause	Suggestions
<i>Wash buffer type 6 was not completely removed before Elution.</i>	<ul style="list-style-type: none">• Make sure during the Wash & Dry step the column is centrifuged for at least 3 minutes to dryness. If humidity level is high, increase the spin time to 5 minutes.
<i>Wash buffer type 6 remained in the column below the frit and was collected in the final elution.</i>	<ul style="list-style-type: none">• The Collection tube was not emptied after the initial sample was spun through the column. This caused the Collection tube to overflow when the wash steps were performed which then caused fluid to remain in the bottom of the column. Empty the Collection tube as described in the procedure. If necessary, place the column back into the Collection tube and spin briefly to remove any residual fluid.

Problem: Purified genomic DNA does not cut to completion with restriction enzymes.

Possible cause

Suggestions

EDTA in the Elution buffer type 5 can inhibit restriction enzymes.

- Elute the sample with heated water to facilitate complete digestion of the product or consider using another restriction enzyme.

Wash buffer type 6 was not completely removed before Elution.

- Make sure during the Wash & Dry step the illustra blood mini column is centrifuged for at least 3 minutes to dryness as described in section 5.3.4. If humidity level is high, increase the spin time to 5 minutes.

Wash buffer type 6 remained in the column below the frit and was collected in the final elution.

- The Collection tube was not emptied after the initial sample was spun through the column. This caused the Collection tube to overflow when the wash steps were performed which then caused fluid to remain in the bottom of the column. Empty the Collection tube as described in the procedure. If necessary, place the column back into the Collection tube and spin briefly to remove any residual fluid.

6.7. Related products

A full range of molecular biology reagents can be found on the GE Healthcare website and in the catalog.

Application	Product	Product code	Pack sizes
Buffer preparation	Water, nuclease-free	US70783	500 ml
Kits containing ready-to-use mix for PCR amplification	illustra Hot Start Master Mix	25-1500-01	100 reactions
	illustra PuReTaq™ Ready-To-Go™ PCR Beads	27-9557-01	96 reactions in 0.2 ml tubes/plate
	illustra puReTaq Ready-To-Go PCR Beads	27-9557-02	5 × 96 reactions in 0.2 ml tubes/plate
	FideliTaq™ PCR Master Mix Plus (2 ×)	E71182	100 reactions
	FideliTaq PCR Master Mix Plus	E71183	100 reactions
Premixed nucleotides for PCR amplification	illustra DNA Polymerization Mix dNTP Set (A,C,G,T) 20 mM each	28-4065-57	10 µmol
	illustra DNA Polymerization Mix dNTP Set (A,C,G,T) 20 mM each	28-4065-58	40 µmol (4 × 10 µmol)

Application	Product	Product code	Pack sizes
Premixed nucleotides for PCR amplification	illustra PCR Nucleotide Mix dNTP Set (A,C,G,T) 25 mM each	28-4065-60	500 µl
	illustra PCR Nucleotide Mix dNTP Set (A,C,G,T) 2 mM each	28-4065-62	1 ml
Preparation of PCR products for automated sequencing	ExoSAP-IT™	US78200	100 reactions
	ExoSAP-IT	US78201	500 reactions
Sequencing reaction kits optimized for MegaBACE™ DNA analysis system	DYEnamic™ ET Terminator Cycle Sequencing Kits	US81050	100 templates
	DYEnamic ET Terminator Cycle Sequencing Kits	US81060	1000 templates

7. References

1. Sambrook, J., Fritsch, E.F & Maniatis, T., *Molecular cloning: A laboratory Manual*, Cold Spring Harbor laboratory, 2nd eds., (1989).
2. Marko, M.A., Chipperfield, R. & Birnboim, H.C., *Anal. Biochem.* 121,382 (1982).
3. Melzak, K. A. et al., *J. Coll. Interf. Sci.* 181, 635-644 (1996).
4. Hilz, H. et al. *Eur. J. Biochem.* 56, 103-108 (1975).
5. Vogelstein, B. & Gillespie, D., *Proc. Natl. Acad. Sci. USA* 76, 615 (1979).
6. Ausubel, F.M. et al., eds., *Current Protocols in Molecular Biology* 1, 1.68 (1991).
7. Baskurt et al., *Am. J. Physiol. Heart Circ. Physiol.* 273, 2604-1612, 1997.
8. http://www.cc.nih.gov/ccc/patient_education/pepubs/cbc97.pdf

DOMINIQUE DUTSCHER SAS

DOMINIQUE DUTSCHER SAS

DOMINIQUE DUTSCHER SAS

GE Healthcare offices:

GE Healthcare Bio-Sciences AB
Björkgatan 30 751 84

Uppsala
Sweden

GE Healthcare Europe GmbH
Munzinger Strasse 5 D-79111

Freiburg
Germany

GE Healthcare UK Limited

Amersham Place
Little Chalfont

Buckinghamshire
HP7 9NA

UK

GE Healthcare Bio-Sciences

Corp

800 Centennial Avenue

P.O. Box 1327

Piscataway

NJ 08855-1327

USA

GE Healthcare Bio-Sciences KK

Sanken Bldg. 3-25-1

Hyakunincho Shinjuku-ku

Tokyo 169-0073

Japan

GE Healthcare regional office contact numbers:**Asia Pacific**

Tel: +85 65 6275 1830

Fax: +85 65 62751829

Australasia

Tel: + 61 2 8820 8299

Fax: +61 2 8820 8200

Austria

Tel: 01/57606-1613

Fax: 01/57606-1614

Belgium

Tel: 0800 73 890

Fax: 02 416 8206

Canada

Tel: 1 800 463 5800

Fax: 1 800 567 1008

Central & East Europe

Tel: +43 1 972 720

Fax: +43 1 972 722 750

Denmark

Tel: 45 70 25 24 50

Fax: 45 45 16 2424

Eire

Tel: 1 800 709992

Fax: 44 1494 542010

Finland & Baltics

Tel: +358 9 512 3940

Fax: +358 9 512 39439

France

Tel: 01 69 35 67 00

Fax: 01 69 41 98 77

Germany

Tel: 0800 9080 711

Fax: 0800 9080 712

Greater China

Tel: +852 2100 6300

Fax: +852 2100 6338

Italy

Tel: 02 26001 320

Fax: 02 26001 399

Japan

Tel: +81 3 5331 9336

Fax: +81 3 5331 9370

Korea

Tel: 82 2 6201 3700

Fax: 82 2 6201 3803

Latin America

Tel: +55 11 3933 7300

Fax: +55 11 3933 7304

Middle East & Africa

Tel: +30 210 96 00 687

Fax: +30 210 96 00 693

Netherlands

Tel: 0800-82 82 82 1

Fax: 0800-82 82 82 4

Norway

Tel: +47 815 65 777

Fax: +47 815 65 666

Portugal

Tel: 21 417 7035

Fax: 21 417 3184

Russia, CIS & NIS

Tel: +7 495 956 5177

Fax: +7 495 956 5176

Spain

Tel: 902 11 72 65

Fax: 935 94 49 65

Sweden

Tel: 018 612 1900

Fax: 018 612 1910

Switzerland

Tel: 0848 8028 10

Fax: 0848 8028 11

UK

Tel: 0800 515 313

Fax: 0800 616 927

USA

Tel: +1 800 526 3593

Fax: +1 877 295 8102

<http://www.gelifesciences/illustra>

GE Healthcare UK Limited

Amersham Place, Little Chalfont, Buckinghamshire, HP7 9NA,

UK



imagination at work

The next two pages are a
protocol card.
Please add to the back page as a
tear off addition.

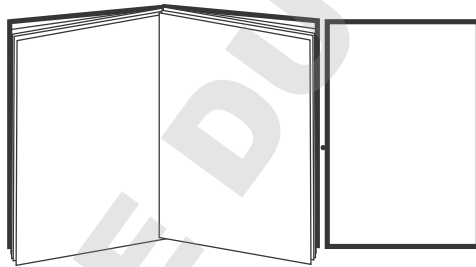

Quick Reference Protocol Card

illustra™ blood genomicPrep Mini Spin Kit





28-9042-64 (50 purifications)
28-9042-65 (250 purifications)

A. Protocol for the purification of genomic DNA from 50–300 µl whole blood and its cell fractions

- Elution buffer type 5, pre-heated to 70°C

 :Add  :Spin  :Incubate

1. Blood cell lysis

-  20 µl Proteinase K
- If sample volume is less than 200 µl, make up to 200 µl with PBS
-  200–300 µl whole blood or its cell fractions
-  400 µl Lysis buffer type 10; vortex to mix
-  10 minutes room temperature
-  Pulse

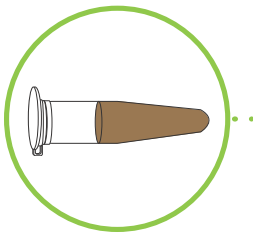

2. Genomic DNA binding

- Load onto assembled column and Collection tube
-  1 minute 11 000 x g; discard flowthrough

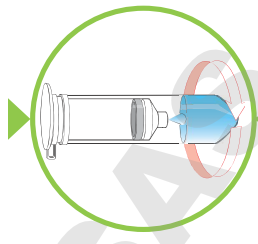

3. Wash

-  500 µl Lysis buffer type 10

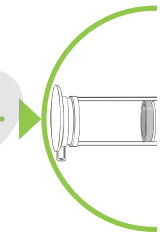

 1 minute 11 000 x g; discard flowthrough

4. Wash & Dry

-  500 µl Wash buffer type 6
-  3 minutes 11 000 x g; discard flowthrough

5. Elution

- Insert column in to a clean DNase-free microcentrifuge tube
-  200 µl Elution buffer type 5, pre-heated to 70°C
-  1 minute room temperature
-  1 minute 11 000 x g
- Collect eluate
- Store purified genomic DNA at -20°C

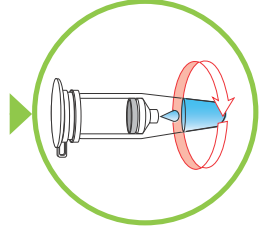
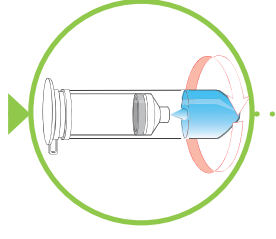
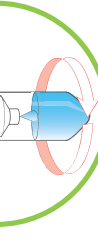

GE and GE monogram are trademarks of General Electric Company.
illustra, puReTaq, FidelityTaq and DYEamic are trademarks of GE Healthcare companies

© 2006–2007 General Electric Company – All rights reserved.
Previously published 2006. Date of revision Apr. 2007.

All goods and services are sold subject to the terms and conditions of sale of the company within GE Healthcare which supplies them. A copy of these terms and conditions is available upon request.

Contact your GE representative for the most current information.
<http://www.gelifesciences.com/lifesciences>

GE Healthcare UK Limited.
Amersham Place, Little Chalfont,
Buckinghamshire, HP7 9NA UK

Quick Reference Protocol Card

illustra™ blood genomicPrep Mini Spin Kit









28-9042-64 (50 purifications)
28-9042-65 (250 purifications)

B. Protocol for the purification of 300–1 000 µl whole blood and its cell fractions

- Prepare RBC lysis buffer
- Ensure Elution buffer type 5 pre-heated to 70°C

 :Add  :Spin  :Incubate

1. Blood cell lysis

-  3 x sample volume of RBC Lysis buffer to centrifuge tube
-  300 µl–1 000 µl sample; mix by inverting the tube
-  5 minutes room temperature
-  2 minutes 500 x g; discard supernatant
-  100–150 µl PBS to bring volume to 200 µl; vortex to re-suspend pellet
- Transfer to a fresh 1.5 ml microcentrifuge tube
-  20 µl Proteinase K
-  400 µl Lysis buffer type 10; vortex to mix
-  Incubate 10 minutes room temperature with intermittent vortexing
- Pulse spin.

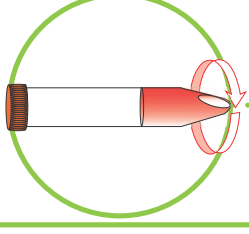

2. Genomic DNA binding



- Load onto assembled column and Collection tube
- 1 minute 11 000 x g; discard flowthrough

3. Wash

-  500 µl Lysis buffer type 10
- 1 minute 11 000 x g; discard flowthrough

4. Wash & dry

-  500 µl Wash buffer type 6
- 3 minutes 11 000 x g; discard flowthrough

5. Elution

- Insert column into a clean DNase-free microcentrifuge tube
-  200 µl Elution buffer type 5, pre-heated to 70°C
- 1 minute room temperature
- 1 minute 11 000 x g
- Collect eluate
- Store purified genomic DNA at -20°C



imagination at work