

TurboCycler 3
High-Throughput Triple-Block Gradient PCR Thermal Cycler

TCTT-4810

Operation Manual



Ver. 1.0









Copyright © 2024 Blue-Ray Biotech Corp.
All Rights Reserved.

DOMINIQUE DUTSCHER SAS

Table of Contents

1. Safety Precautions	1
1.1 Intended Use	1
1.2 Safety Label	1
1.3 General Instrument Safety	1
1.4 Electrical Safety	2
2. General Description	3
2.1 Features	3
2.2 Product Overview	4
3. Getting Started	7
3.1 Unpacking.....	7
3.2 Initial Operation.....	7
3.3 Lid Opening/Closing.....	8
3.4 Heated Lid.....	8
3.5 Loading the Reaction Vessel	10
3.6 Main Screen.....	12
4. User Folder Management	13
4.1 Creating a New User Folder	13
4.2 Viewing a User Folder.....	13
4.3 Editing a User Folder	14
4.4 Deleting a User Folder	14
4.5 Using USB Flash Drive as a User Folder	14
5. Protocol Management	15
5.1 Creating a New Protocol.....	15
5.2 Saving a Protocol.....	18
5.3 Editing (Viewing) a Protocol	19
5.4 Deleting a Protocol	19
6. Protocol Running Management	20
6.1 Running a Protocol.....	20
6.2 Monitoring the Protocol Running Status	22
6.3 Pausing a Running Protocol.....	22
6.4 Terminating a Running Protocol.....	22
7. Tools	23
7.1  Tm Calculator	23

7.2		Mastermix Preparation Wizard.....	23
7.3		Copy Number Converter.....	23
7.4		Incubator.....	23
7.5		Help.....	23
8.		System Setup.....	24
8.1		Service Mode	24
8.2		Administration	24
8.3		Factory Mode	24
9.		Maintenance.....	25
9.1		Cleaning the Unit	25
9.2		Cleaning the Heated Lid	25
9.3		Replacing a Fuse	25
9.4		Block Temperature Verification	25
10.		Troubleshooting	26
10.1		Error Messages	27
		Appendix A: Technical Specifications	28
		Appendix B: Template Protocols.....	29
		Appendix C: CE Declaration	31
		Appendix D: Order Information	32

DOMINIQUE DUTSCHER SAS

1. Safety Precautions

Before using the **TurboCycler 3** for the first time, please read this entire operation manual carefully. To guarantee problem free, safe operation of the **TurboCycler 3**, it is essential to observe the following section.

1.1 Intended Use

This instrument is intended to be used by trained personnel to perform PCR. In this manual, we assume the user to have knowledge of basic laboratory procedures and PCR chemistry.

1.2 Safety Label



High Temperature Label: Please be aware of the heated components.

1.3 General Instrument Safety

PHYSICAL INJURY HAZARD. Using the instrument in a manner not specified by Blue-Ray Biotech may result in personal injury or damage to the instrument.

1.3.1 Transportation and Storage

TurboCycler 3 should be transported or stored in an environment with a temperature between -10 and 60 °C, and with a relative humidity of 85% or less.

1.3.2 Installation and Operation

1. Do not use the device in a potentially explosive environment or with potentially explosive chemicals.
2. Install the device in a location free of excessive dust.
3. Avoid placing the device in direct sunlight.
4. Choose a flat, stable surface capable of bearing the weight of the device.
5. Install the device in a room with a temperature of 15 ~ 35 °C, and relative humidity of 85% or less.
6. **MAKE SURE** the air vents are unobstructed.
7. Keep the front and rear of the device at least 10 cm from the wall or other equipment.
8. Make sure the power source conforms to the required power supply specifications.
9. To avoid electric shock, make sure the device is plugged into a grounded electrical outlet.
10. Do not allow water or any foreign objects to enter the various openings of the device.
11. Do not remove the block(s) while the power is on.

1.3.3 Cleaning, Decontaminating, and Servicing the Instrument

Before using a cleaning or decontamination method other than those recommended by the manufacturer, verify with the manufacturer that the proposed method will not damage the equipment.

Switch off and unplug the device before cleaning, servicing, or replacing the fuses.

Repairs should be carried out by authorized service personnel only.

1.3.4 Instructions for Disposal

Do not dispose of this product as unsorted municipal waste. Follow local municipal waste ordinances for proper disposal provisions to reduce the environmental impact of waste electrical and electronic equipment (WEEE).

European Union customers:

Call your local Blue-Ray Biotech Customer Service office for equipment pick-up and recycling.

1.4 Electrical Safety

ELECTRICAL SHOCK HAZARD. Severe electrical shock can result from operating the **TurboCycler 3** without its instrument panels in place. Do not remove instrument panels. High-voltage contacts are exposed when instrument panels are removed from the instrument.

1.4.1 Fuses

FIRE HAZARD. Improper fuses or excess voltage can damage the instrument wiring system and cause a fire. Before turning on the instrument, verify that the fuses are properly installed and that the instrument voltage matches the power supply in your laboratory. For continued protection against the risk of fire, replace fuses only with proper fuses with a rating specified for the instrument.

1.4.2 Power

ELECTRICAL HAZARD. Grounding circuit continuity is vital for the safe operation of equipment. Never operate equipment with the grounding conductor disconnected. Use properly configured and approved line cords for the voltage supply in your facility. Plug the system into a properly grounded receptacle with adequate current capacity.

2. General Description

TurboCycler 3 stands as the most ultimate high-throughput PCR thermal cycler in its class. With the capacity to run three distinct PCR protocols while handling 3 x 48 samples at once, you'll experience unrivaled flexibility. It provides fast gradient optimization and advanced ramp rate control, perfectly tailored to meet your specific assay requirements. These features unite to turbocharge your productivity and efficiency.

2.1 Features

➤ **Blocks**

- Three independent blocks
- Flexible ramp rate control
- Easy-to-operate lid design
- Normally runs even with 1 or 2 block(s) absent
- Heated lid to prevent the formation of condensation
- Compatible to almost all commercial PCR tubes

➤ **Screen and UI**

- 10.1-inch color touch screen enhances visibility and ease of operation
- Simple and easy-to-use graphical interface
- Preset protocol templates make starting amplification easier
- Automatically creates operating history and error logs
- Auto restart of a running protocol after power failure

➤ **Outlook**

- Small space-saving footprint
- Robust and modern outlook design

➤ **Applications**

- High throughput screening
- Gradient function enables optimization of annealing temperatures
- Temperature increment/decrement function makes touchdown PCR possible

2.2 Product Overview

2.2.1 Top View

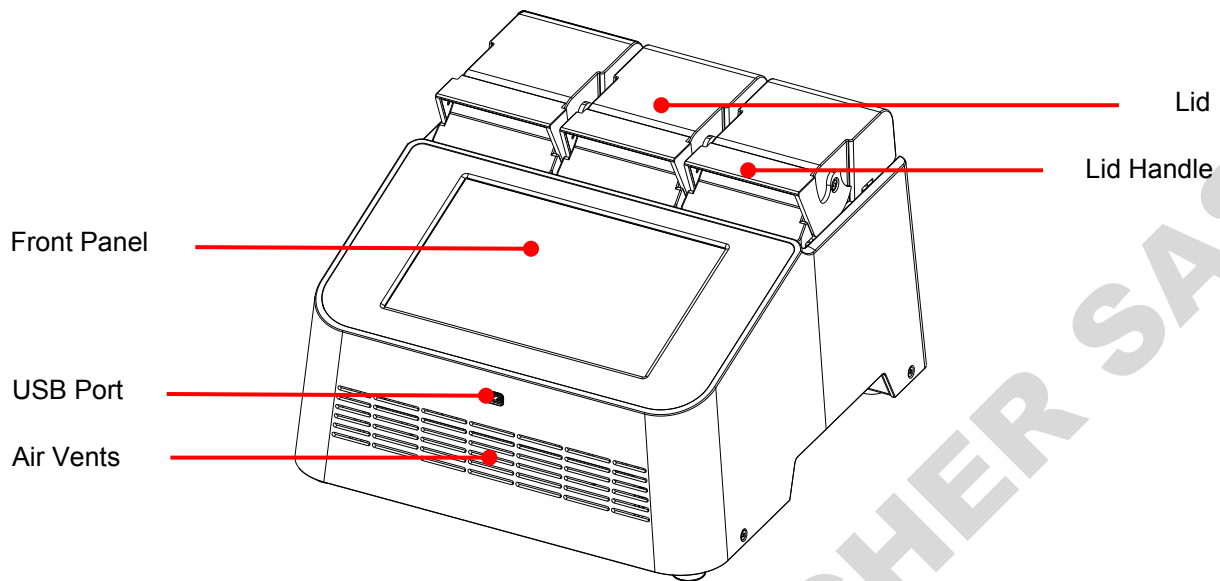

Figure 1. Top view

Table 1. Detailed description for top view

Name	Function
Front Panel	10.1" high-resolution color LCD with capacitive touch panel. It displays the current status of the system and allows the user to operate the instrument.
USB Port	For protocol and run log output via USB flash drive.
Air Vents (Front)	For air intake.
Lid	The heated lid is designed to prevent condensation inside the reaction vessels during the PCR temperature cycling.
Lid Handle	Easy-to-operate handle without tedious rotating mechanism, designed to withstand long-term operation.

2.2.2 Top View of Block With Opened Lid

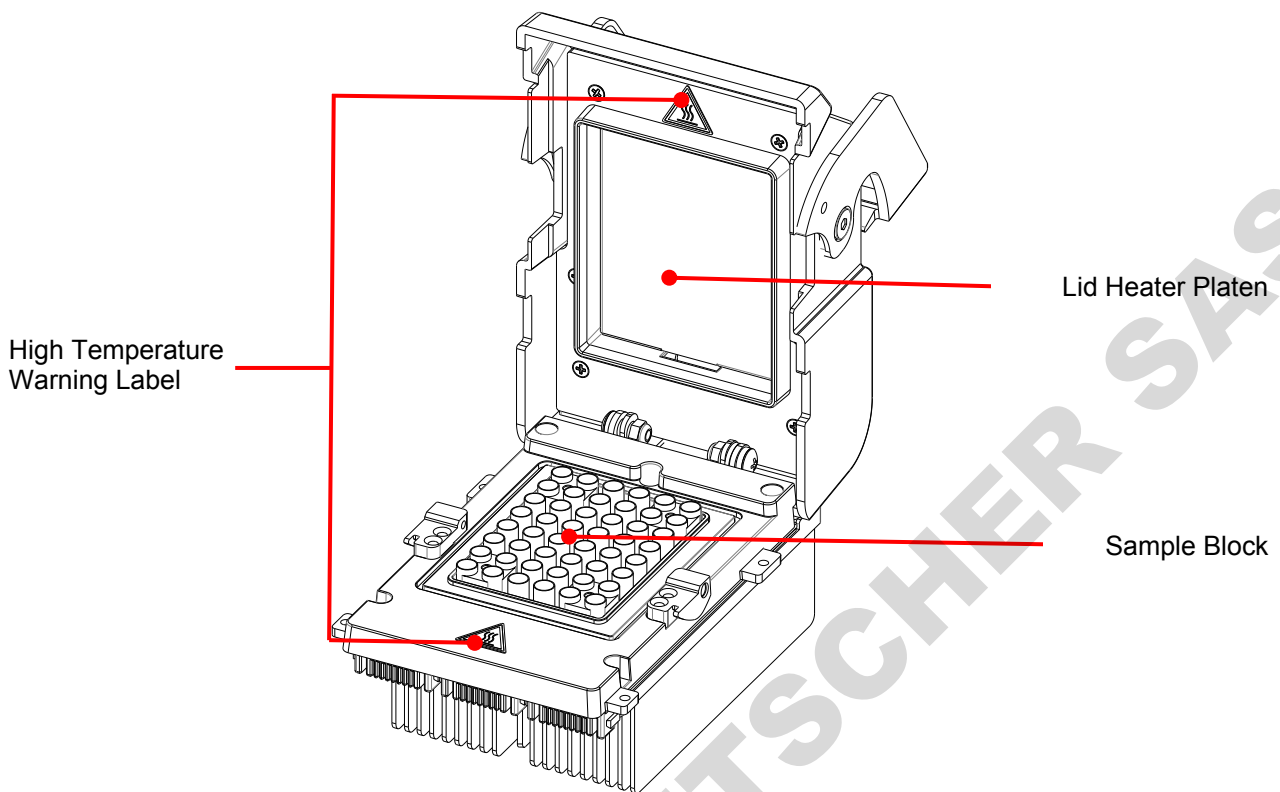

Figure 2. Top view of block with opened lid

Table 2. Detailed description for top view of block with opened lid

Name	Function
High Temperature Warning Label	During and after PCR operation, the lid heater platen and the sample block may become very hot (up to 130 °C). Please be aware of the high temperature.
Lid Heater Platen	The heater platen is designed to prevent condensation inside the reaction vessels and to place consistent pressure on the top of the reaction vessels. This pressure will ensure efficient contact between the reaction vessels and the sample block for better heat conduction. It will also help prevent the leakage of sample vapor due to the weak vessel caps or sealing.
Sample Block	Section of the unit to hold the reaction vessels.

2.2.3 Rear View

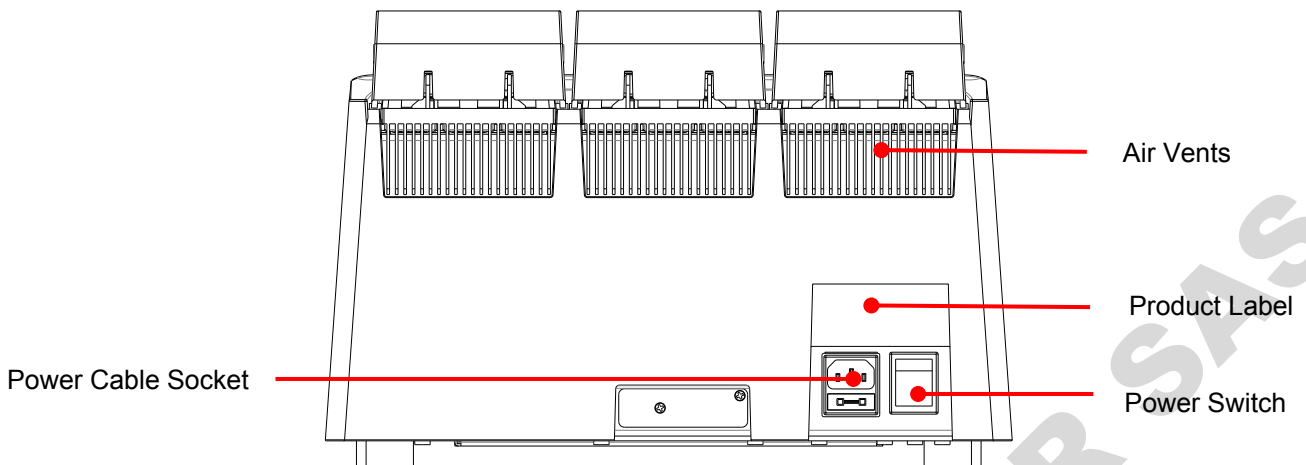

Figure 3. Rear view

Table 3. Detailed description for rear view

Name	Function
Power Cable Socket	Power cable socket and fuse compartment.
Power Switch	Power On/Off switch.
Product Label	Indicates the model's name, serial number, power specification, and other important information.
Air Vents (Rear)	For air output.

3. Getting Started

3.1 Unpacking

Open the **TurboCycler 3** package and confirm that all items below are included:

- **TurboCycler 3** unit x 1
- Quick operation guide x 1 (with QR code for downloading Operation Manual)
- Calibration report x 1
- 5 mm compression mat x 3
- Tube frame x 3
- European AC power cord x 1
- American standard AC power cord x 1
- Spare electric fuses (10 A) x 1

Note
Plug type varies according to different countries.

If any items are missing, damaged, or incorrect items in the package, please contact your distributor or sales representative immediately.

3.2 Initial Operation

Place the device on a steady, flat table. Keep the front and rear of the device at least 10 cm from the wall or other devices. Check that the power source is compatible with your device's fuse rating input. Connect the power cord to the power socket at the rear of the device.

Switch on the device using the power switch at the rear of the device. The LCD will show the boot screen and then the "**TurboCycler 3**" title will be displayed. Tap on the "**TurboCycler 3**" title to log into the **Main Screen** and start your operation. Tap on the "**TurboCycler 3**" title again on the **Main Screen** to log out.

Switch off the device when not in use.

3.3 Lid Opening/Closing

To open the lid, pull the handle upward and lift the lid backward as shown in Figure 4 to the upright position.

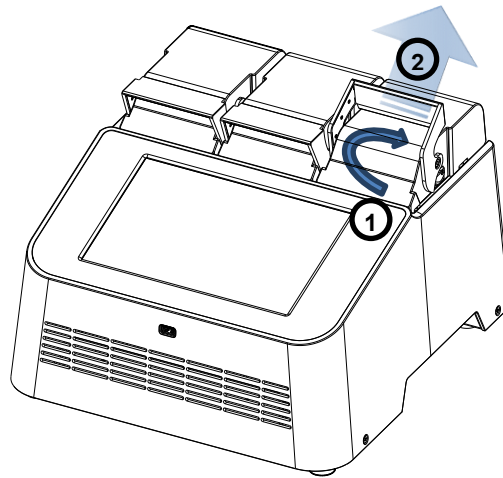

Figure 4. Opening the lid

To close the lid, pull the lid downward and close the handle to the lock position as shown in Figure 5.

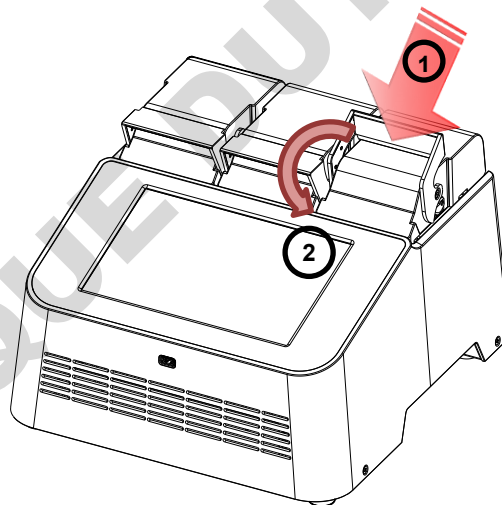

Figure 5. Closing the lid

3.4 Heated Lid

The Heated Lid heats the air in the upper part of the sample vessels at a higher temperature than the reaction mixture. This prevents condensation of the evaporated water vapor on the vessel walls, keeping the concentration of the reaction mixture unchanged during the heating and cooling cycles. The heater platen also applies pressure on the caps or sealing film on the vessels to prevent vapor loss and cross contamination of samples.

Due to the height difference between the standard profile vessels and the low profile vessels, it is required to use the **5 mm Compression Mat** for low profile vessels and a **Tube Frame** for regular profile vessels (standard accessory shipped with **TurboCycler 3**). The **Tube Frame** provides support and evenly distributes the pressure across the block, which prevents reaction vessels from deformation. The **Compression Mat** will help place even and sufficient pressure on the caps or sealing on the vessels. Please refer to Table 4 for further information.

Table 4. Lid heater setting guide

PCR vessels	Accessory	Lid heater temperature
Regular PCR plates, strips, and tubes	The tube frame should be used to help maintain the equilibrium pressure in case the PCR plate becomes deformation.	105 °C
Low-profile PCR plates, strips, and tubes	The 5 mm compression mat must be used to ensure sufficient contact pressure from the heated lid.	130 °C

Note

1. If **TurboCycler 3** is started cold, approximately two to three minutes will be required for the lid heater platen to reach the setting temperature. If the low-profile reaction vessels and the 5 mm compression mat are used, an extra seven minutes will be required to allow the compression mat to be heated to the required 130 °C temperature.
2. The extra **Tube Frame** can be purchased separately (Cat. # TCTT-a001).
3. The extra **5 mm Compression Mat** can be purchased separately (Cat. # TCTT-a002, pack of 3 mats).

3.5 Loading the Reaction Vessel

For the optimal performance of the **TurboCycler 3**, the recommended sample volume for 0.2 ml reaction vessels is 5-100 μl , and the **Tube Frame** should be applied if using tubes or strips. For low-profile vessels, it is required to use a **5 mm Compression Mat** which will help place even and sufficient pressure on the caps or sealing on the vessels, and the recommended sample volume is 5-50 μl .

To apply the **Compression Mat**, follow the instruction shown in Figure 6.

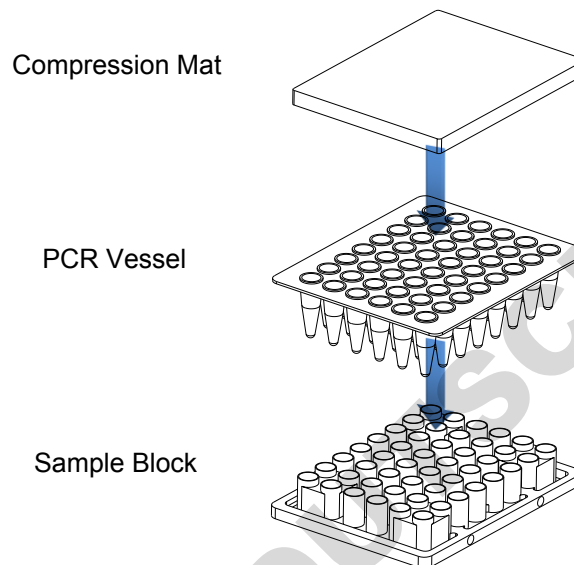

Figure 6. Applying the compression mat

To apply the **Tube Frame**, follow the instruction shown in Figure 7.

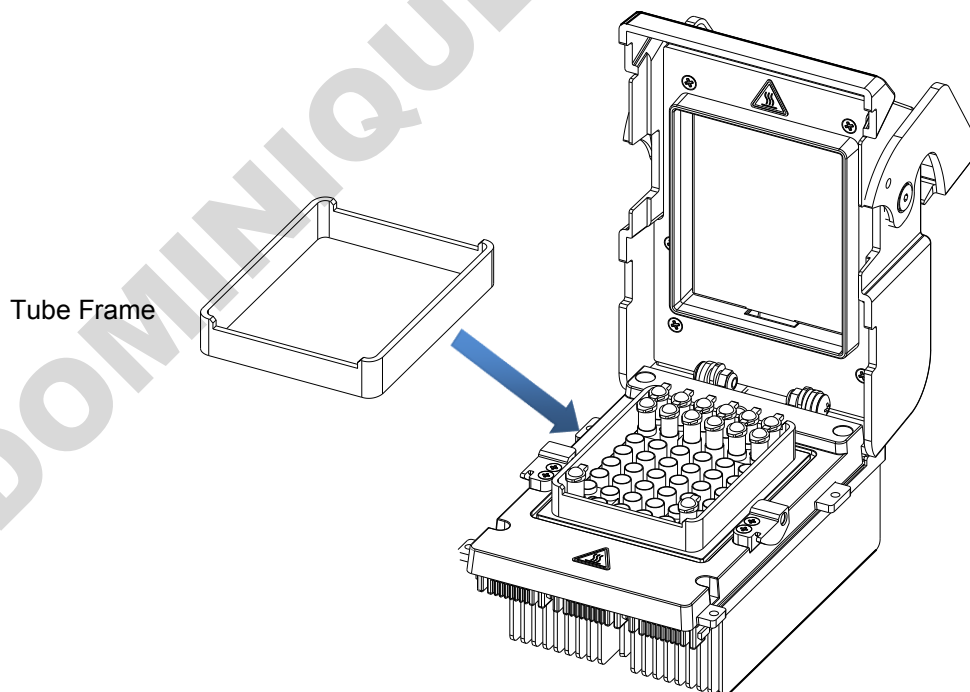

Figure 7. Applying the tube frame

To prevent the deformation of the low profile PCR vessels, and to ensure even distribution of the pressure from the lid, when PCR tubes or strip tubes are used, please load extra empty tubes on the 4 corners of the sample block as shown in Figure 8. Always make sure that all the sample tubes/strip tubes are distributed evenly on the sample block.

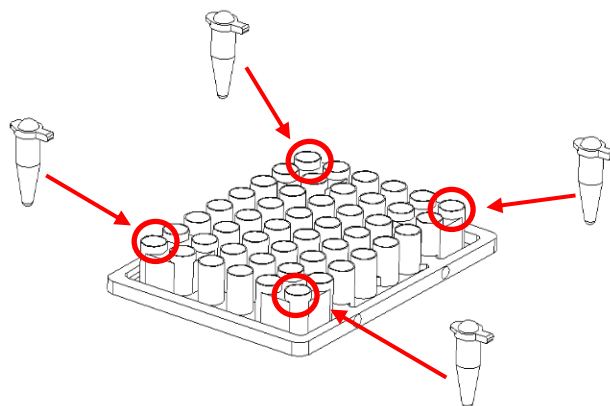

Figure 8. Loading extra tubes

DOMINIQUE DUTSCHER SAS

3.6 Main Screen

On the **Main Screen**, there are some information items indicating the status of the **TurboCycler 3**, it contains 8 main function icons. There are three selections of blocks below the 8 main function icons. Tap on the block number or the icon to select the block. Please refer to Figure 9 and Table 5 for a detailed description.

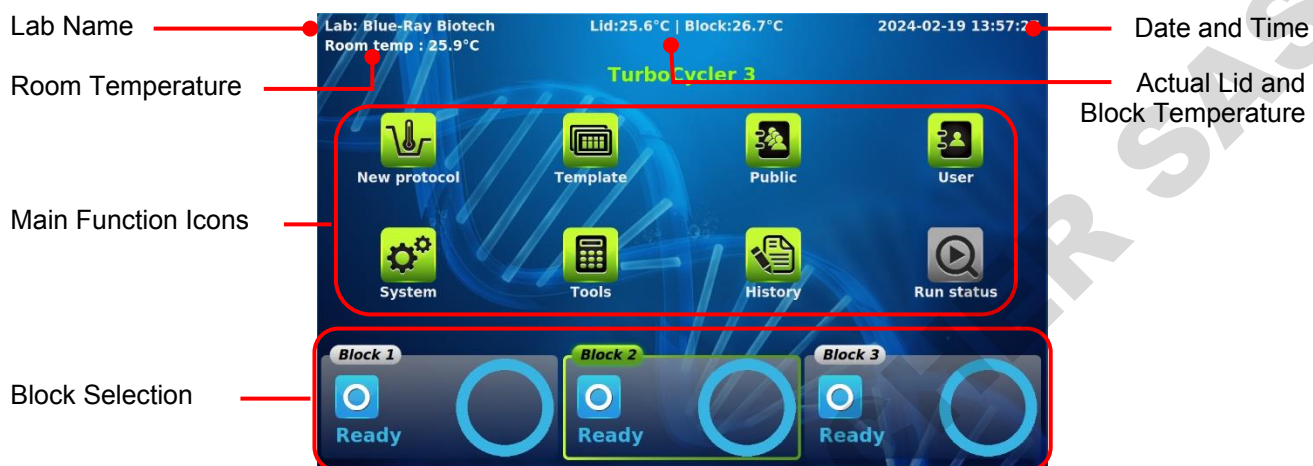









Figure 9. Main screen overview

Table 5. Main function icons

Main function icons	
	New Protocol For new protocol creation and editing
	Template Built-in protocol template
	Public Shortcut to the public folder
	User For user folder management
	System System setting
	Tools Built-in assistant tools
	History Protocol run history logbook
	Run Status Display the status of the running protocol

4. User Folder Management





After selecting a block, tap on the **User** icon  on the main screen to enter the **User Folder** management screen. A sample screen is shown in Figure 10 below.



Figure 10. User folder overview

All Protocols are stored inside the user folders. There are 12 user folders displayed on one page. If there are more than 12 user folders registered in the system, you can slide up or down on the screen or tap on   to see the other pages.

The lock symbol  on the lower right corner of the folder icon indicates that the folder is password protected.

Users can utilize the function icons on the lower part of the screen to open, create, edit, and delete the user folders. The **Home** icon  is used to return to the **Main Screen**.



Note

The **Public** folder is a preset folder that cannot be deleted and requires no password to enter.

4.1 Creating a New User Folder

On the **User Folder** screen, tap on the **New** icon  to create a new User Folder. Input the folder name and password (optional). Tap the user icon (10 different male and female icons are available) to change the icon for the new folder.

4.2 Viewing a User Folder



To view the contents in a **User Folder**, tap on the folder icon to select and highlight it. You can then tap for the second time or tap on the **Open** icon  to open it. If the folder is password protected, you'll be requested to input the password. Input the password and tap **OK** to confirm the password or tap on **CANCEL** to abort the operation. If the password is entered correctly, the folder will then be opened. If the password is entered incorrectly, a warning message box will pop up indicating the wrong password was inputted. Tap on  to return to the password input screen and input

the correct password. To run a Protocol, please refer to Section 6.1.

4.3 Editing a User Folder

To edit the properties of a **User Folder**, tap on the folder icon to select and highlight the folder, then tap on the **Edit** icon  to edit it. You can change the folder name and password (optional) or change the icon you want to use for the folder. Tap on OK to store and finish the editing.

4.4 Deleting a User Folder

To delete a **User Folder**, tap on the folder icon to select and highlight the folder, then tap on the **Delete** icon  to delete it. You are required to enter the password if the folder is password protected. The screen will prompt "Do you want to delete the folder?". Tap on  to confirm the deletion. Tap on  to abort the deletion.

Note
User folders that contain any protocols cannot be deleted. You should delete all the protocols in them first.

4.5 Using USB Flash Drive as a User Folder

You can use a USB flash drive as a **User Folder** to store your protocols. You can also use the USB flash drive to transfer the protocols between different **TurboCycler series units**. Please insert your USB flash driver into the front USB port and wait for 5-10 seconds (depends on the specification of the flash drive. It is recommended to format your flash drive in FAT or FAT32 file system prior to using it on **TurboCycler 3**) for the **TurboCycler 3** to recognize it and create a required folder in it. Tap on the **USB** icon  to open the specific folder (\\TPCR_Files) in the flash drive and use it as a **User Folder**.

5. Protocol Management

After entering the selected **User Folder**, the protocol list will be displayed. A sample screen is shown as Figure 11 below. Users can utilize the function icons on the lower part of the screen to edit, create, delete, duplicate (save as new protocol), and open the protocols. The **Back** icon  is used to return to the **User Folder** screen.



Figure 11. Protocol list

5.1 Creating a New Protocol



A new **Protocol** can be created by going to the **User Folder** and tapping on the **NEW** icon . A new protocol with a standard template will be created in the folder. Alternately, select a block you are going to use, then tap on **New Protocol** icon  on the Main Screen. In this way, the new protocol can be saved to any selected User Folder later. The protocol editing screen is shown as Figure 12 below.





Figure 12. Standard protocol template

During your editing, if the **Protocol** contains too many **Stages/Steps** that cannot be completely displayed on the screen, you can slide right or left on the screen to see the other part of the **Protocol**.

You can also use the built-in protocol templates as your starting point for a new protocol by tapping on the **Template** icon  on the **Main Screen** and choose one of the templates in it. Please refer to **Section 5.3 Editing (Viewing) a Protocol** for detailed instructions.

5.1.1 Changing Temperature/Time/Ramp Rate Setting

- To select the **Step**, tap on the step segment. The selected **Step** will be highlighted and the **Step Temperature, Time and Ramp Rate**  will be displayed. Tap on  and a spinning wheel will pop up as shown in Figure 13, allowing you to modify the **Step Temperature, Step Time, or Step Ramp Rate**.

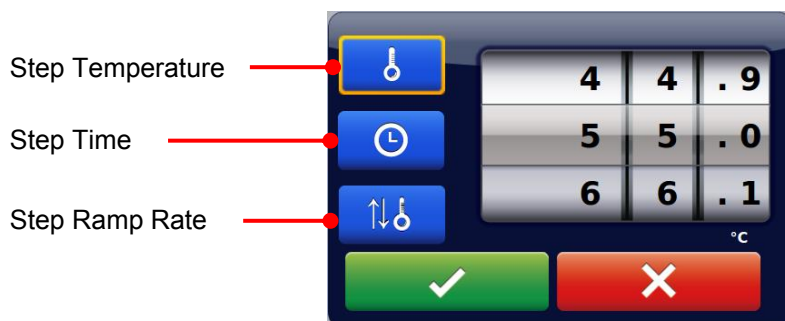



Figure 13. Temperature/Time/Ramp rate setting

- Tap on the **Temperature, Time or Ramp Rate** setting function icon and spin the wheel to the desired value. Tap on  to accept the setting. Tap on  to abort the operation.

The temperature and time ranges are shown below.

Temperature range: 4.0 to 100°C



Time range (minute: second): 00:01 to 99:59

Ramp Rate range: 0.1 to 5.0 °C/sec.

Note

If the last **Stage** contains only one **Step** segment, the ∞ check box will be activated in the **Time** setting spinning wheel, allowing you to set the infinity hold at the end of the protocol.



5.1.2 Inserting/Deleting a Stage or Step Segment



Tap on the **Stage** header or the **Step** segment. The selected area will be highlighted. Tap on the **New**  or the **Delete**  function icon to duplicate or delete the selected **Stage/Step**.

Note

- If you delete all the **Steps** in a **Stage**, the entire **Stage** will be deleted.
- If there is only one **Stage** left in the protocol, it cannot be deleted.
- In a **Stage** which contains only one **Step**, if you duplicate the **Step**, the **Stage Cycle Number** will be set to 2. Please refer to **Section 5.1.3 Changing Stage Cycle Number** for further instruction.

5.1.3 Changing Stage Cycle Number

If a **Stage** contains more than one **Step** segment, the **Stage Cycle Number**  will appear when you tap on the **Stage** header to highlight it. The **Stage Cycle Number** indicates the total number of times the Stage will repeat itself during the running of the protocol. Tap on  and the **Cycles** spinning wheel will pop up as shown in Figure 13 below, allowing you to modify the **Stage Cycle**

Number. Spin the wheel to the desired number and tap on  to accept the setting or tap on  to abort the operation.

The Stage Cycle Number range: 2 to 99.

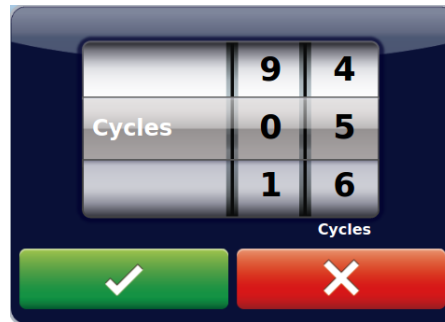

Figure 14. Cycle number setting

5.1.4 Advanced Option Settings

Users can set up the following advanced option functions for the **Steps** in a multi-step **Stage**:

- 1) **Temperature Gradient**
- 2) **Temperature Increment/Decrement**
- 3) **Time Increment/Decrement.**

Tap the specific **Step** to highlight it and tap on the **Option** icon . The **Option** spinning wheel shown in Figure 15 will be displayed.



Figure 15. Advanced option



5.1.4.1 Gradient Temperature Setting

Tap on the **Temperature Gradient** setting function icon, and spin the wheel to the desired value for the gradient temperature span from the original temperature of the **Step**. The value 00.0 turns off the **Gradient**.

The Gradient temperature ranges are shown below.

Temperature range for gradient option: 30.0 to 100.0 °C

Gradient temperature span: 0.1 to 30.0 °C

1. Tap on  to accept the setting or tap on  to abort the operation. A table will pop up displaying the calculated gradient temperature from row A to H. Tap on  to confirm the setting.



Note

The temperature values between the B and G rows are calculated values and represent an algorithmic based on the heat distribution throughout the sample block.

5.1.4.2 Temperature Increment/Decrement Settings

1. Tap on the **Temperature Increment/Decrement** setting function icon, spin the wheel to the desired value for the temperature increment/decrement per cycle. The value 0.0 turns off the **Temperature Increment/Decrement**.

Max. Temperature incremental/decrement value: +/- 9.9 °C

2. Tap on  to accept the setting or tap on  to abort the operation.



Note

Temperature limits 4.0 °C to 99.9 °C. DO NOT exceed.

5.1.4.3 Time Increment/Decrement Settings

1. Tap on the **Time Increment/Decrement** setting function icon, spin the wheel to the desired value for the time increment/decrement per cycle. The value 0.0 turns off the **Time Increment/Decrement**.



Max. Time increment/decrement value (minute : second): +/- 9:59

2. Tap on  to accept the setting or tap on  to abort the operation.

Note

Time limit is 99:59. DO NOT exceed time limit.

5.2 Saving a Protocol



After all settings are entered, tap on the **Save** icon  to store the protocol. Input the protocol name in the pop-up screen and tap on "OK". If you create a new protocol from the **Main Screen**, you'll then be brought to the **User Folder** selection screen. Tap on a **User Folder** icon to select the folder, and then tap on  to save to the folder. Alternately, you can tap on the **USB** icon  to save the protocol to the USB flash drive inserted. If you create your new protocol in a **User Folder**, after you input the protocol name and tap on "OK", the protocol will be saved to the folder directly.

5.3 Editing (Viewing) a Protocol

To edit a **Protocol** in the User's protocol list, tap on the **Protocol** name to select it first. The selected **Protocol** will be highlighted. You can then tap it the second time or tap on the **Open** icon  to open it. Please refer to **Section 5.1.1~5.1.4** to edit the temperature segment and numerical values, and other advanced functions. After all settings are edited, please refer to **Section 5.2** to save the edited **Protocol** to the original folder. An edited **Protocol** can be saved under a new name (as a newly created **Protocol**) or under the same name (overwrite the original **Protocol**).

You can use the **Edit Name** icon  to change the **Protocol** name.

5.4 Deleting a Protocol

Tap to select the **Protocol** to be deleted. The selected **Protocol** will be highlighted. You can then tap on  the **Delete** icon to delete it. A dialog box will pop up requesting you to confirm the operation. Tap on  to confirm the deletion. Tap on  to abort the operation.

Note
Protocols in the Template and Public folder can't be deleted.

6. Protocol Running Management



Caution: During the running of the protocol, the lid heater and the sample block may become very hot. Please be aware of the high temperature.

6.1 Running a Protocol

Please refer to *Section 5.3 Editing (Viewing) a Protocol* to open and check the setting of a Protocol.

Tap on **Run** icon  to initiate the run. Users are requested to select the temperature control mode of the **Lid Heater**, the **Sample Block**, and **Multiple Blocks**.

- 1 **Lid Heater** temperature control mode.



Figure 16. Lid heater control mode

Please refer to *Section 3.4* for detailed information. Tap on the **Next** icon  to go to the **Sample Block** temperature control mode screen.

- 2 **Sample Block** temperature control mode:
 - i. **Block Mode:** Enables system operation with maximum temperature control based on the actual block temperature regardless of the sample temperature. This mode is designed to mimic the control algorithm of the early day thermal cyclers.
 - ii. **Sample Mode:** Enables system operation with simulated temperature control. Users are required to input the sample volume: 5-100 μ l. In this mode, the temperature control algorithm will estimate the sample temperature based on the block temperature and the sample volume. This is recommended for normal operation.

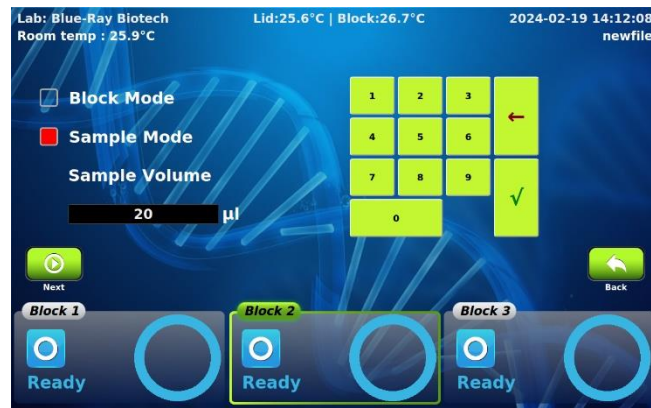

Figure 17. Sample block control mode

Tap on the **Next** icon  to go to the **Multiple Blocks** selection mode screen.

3 Multiple Blocks selection mode.

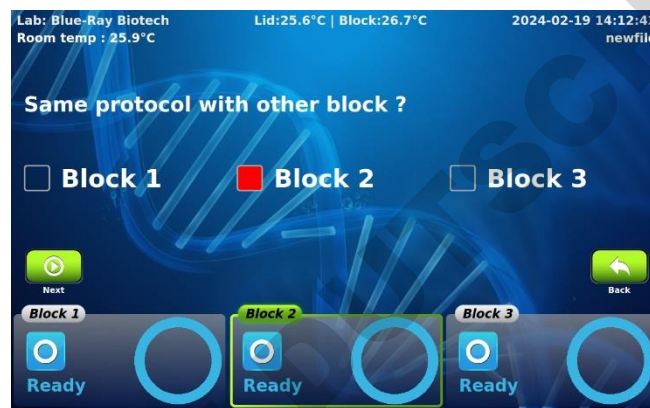



Figure 18. Multiple blocks selection mode

Select the additional 1 or 2 block(s) to run the same protocol, if the quantity of your samples is large. Tap on **Run** icon  to start the run.

6.2 Monitoring the Protocol Running Status

During the running of the protocol, the running status screen will be displayed as shown in Figure 19 below. The running **Step** is highlighted in red (heating) or blue (cooling). Tap on different blocks to view each status.

Current Lid and
Block Temperature

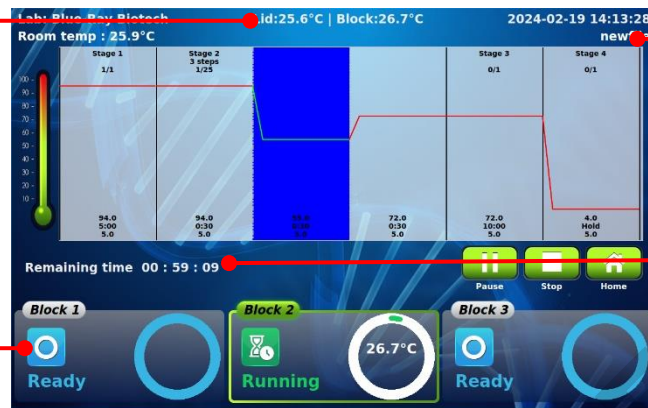

Folder/ Protocol
Name



Protocol
Remaining Time

Block Status

Figure 19. Running protocol

You can use the **Home** icon  to go to the **Main Screen** for other operation. To return to the running protocol, tap on the **Run Status** icon  on the **Main Screen**.



6.3 Pausing a Running Protocol

To pause a running **Protocol**, tap on the **Pause** icon , a dialog box will pop up, requesting you to confirm the operation. The protocol running will not be interrupted before your confirmation. Tap on  to confirm the pause. Tap on  to abort the operation.

During the pause period, the temperature of the lid heater and the sample block will be kept and the countdown timer of the **Step** will be paused. The **Pause** icon will be converted to the **Resume** icon .

To resume the paused protocol, tap on .

6.4 Terminating a Running Protocol

To stop a running **Protocol**, tap on the **Stop** icon , a dialog box will pop up, requesting you to confirm the operation. The protocol will not be interrupted before your confirmation. Tap on  to confirm and stop the run. Tap on  to abort the operation.

7. Tools

Tap on the **Tools** icon  on the **Main Screen** to enter the **Tools** section as shown in Figure 20 below. 5 built-in tools are designed to assist you for your routine tasks.



Figure 20. Tools overview

7.1 Tm Calculator

Calculate the Tm, length, GC% and the molecular weight for the input primer.

7.2 Mastermix Preparation Wizard

Calculate the volume of the reagents needed to make the mastermix.

7.3 Copy Number Converter

Convert the DNA concentration into copy number.

7.4 Incubator

Allows you to use **TurboCycler 3** as an incubator.

7.5 Help

Display the quick operation guide for **TurboCycler 3**.

8. System Setup

Tap on the **System** icon  on the **Main Screen** to enter the **System** menu as shown in Figure 21 below.



Figure 21. System overview

8.1 Service Mode

Here you can adjust several parameters for the **TurboCycler 3**.

8.1.1 Brightness

You can change the brightness of the display panel according to your environment's lighting condition.

8.1.2 Beep Sound

You can turn **ON** or **OFF** the beep sound from here.

8.1.3 Date & Time

Users can change the date and time of the **TurboCycler 3** from here.

8.2 Administration

The default password of Administrator is "**Blue-ray**". The Administrator of this unit has rights to delete any **User Folder** and any **Protocols** inside a **User Folder**. You can change the Administrator password and the Lab Name from here.

8.3 Factory Mode

Only authorized service personnel have the password to enter Factory Mode and perform necessary maintenance and repairs.

9. Maintenance

9.1 Cleaning the Unit

Please ensure that no liquid is spilled onto or into the unit. In addition, periodically wipe it, clean of dust, and other residue that comes with normal operation of the unit. Use a soft, lint-free cloth and deionized water. Air vents should be vacuumed to remove dust.

9.2 Cleaning the Heated Lid

Make sure the **TurboCycler 3** is turned off, unplugged, and cooled down. Use mild detergents to clean material from the lid. A Kimwipe™ dipped in 70% ethanol will help remove residue from the sealing tape. Make sure the lid is dry prior to plugging in the power cable.

9.3 Replacing a Fuse

The fuse is in the power socket module, just below the power connector. If the unit does not turn on when the power switch is turned on, you may need to check and replace the fuse.

To replace the fuse:

1. Disconnect the power cord from the unit.
2. Remove the fuse drawer with a small-blade screwdriver.
3. Pull the fuse out of the fuse socket.
4. Reinsert the new fuse into the fuse socket. Reinsert the fuse drawer.

9.4 Block Temperature Verification

To ensure the efficiency and performance of each reaction, Blue-Ray Biotech recommends you do temperature verification annually. These 3 independent blocks can keep running with 1 or 2 block(s) absent. Call your local Blue-Ray Biotech Customer Service office for block temperature verification.

Note
Do not remove block while the power is on.

10. Troubleshooting

Problem	Cause	Action
During the protocol, the running status screen shows warning icon 	Operating temperature environment may be unsuitable.	Operate the unit in a temperature environment between 15 to 30 °C.
The display is off even when power is switched on.	Power is not reaching the system.	Check power source voltage.
	Power cord is not plugged into the socket properly.	Reconnect the power cord.
	Power fuse is blown out.	Replace the power fuse.
	Block fuse is blown out.	Return the unit for service.
	Panel is out of function.	Return the unit for service.
Can't reach 4°C.	Operating temperature environment may be unsuitable.	Operate the unit in a temperature environment between 15 to 30 °C.
	Electronic cooling element may be damaged or aged.	Return the unit for service.
Cycle time is too long.	Operating environment temperature may be unsuitable.	Operate the system in a temperature environment between 15 to 30 °C.
	Electronic cooling element may be damaged or aged.	Return the unit for service.
	Faulty temperature sensor.	Return the unit for service.
Lid heater does not work.	Lid heater is set to off.	Check Lid Temperature setting in System Mode.
	Lid sensor problem.	Return the unit for service.
No beep sound when tapping icons.	Sound may currently be set to off.	Check Beeper setting in System Mode.
	Faulty touch panel.	Return the unit for service.
The display goes off.	Faulty backlight.	Return the unit for service.
	Faulty LCD panel	Return the unit for service.
Display is too dark or bright.	Display brightness is not adjusted properly.	Adjust Display Brightness according to environmental lighting condition.
Lid will not close.	Foreign object between lid heater and sample block.	Remove the foreign object or matter.
	Faulty lid lock mechanism.	Return the unit for service.
Error message appears.	Refer to list of error messages in Section 10.1 below.	Check the nature of the error and take the suggested actions.

10.1 Error Messages

Message	Cause	Action
Error 1: Heater overheat!	Lid temperature exceeds 145 °C.	Reboot the unit.
Error 2: Heater performance failure!	Lid heater problem.	Reboot the unit.
Error 3: Heater temperature inaccuracy!	Lid heater problem.	Reboot the unit.
Error 4: Block sensor error!	Block temperature sensor problem.	Reboot the unit.
Error 5: Block overheat!	Block temperature exceeds 110°C.	Reboot the unit.
Error 6: Block performance failure!	Block thermoelectric module problem.	Reboot the unit.
Error 7: Block temperature inaccuracy!	Block thermoelectric module problem.	Reboot the unit.
Error 8: Block detection failure!	The block connection is not proper.	After turn of the power, reconnect the block. Then reboot the unit.
Error 9: System communication failure!	Poor connection between panel and main board.	Reboot the unit.

If the same error message appears after rebooting the unit, please return the unit for service.

Appendix A: Technical Specifications

Sample Block	
3 X 48 well, Gradient Block	Compatible with regular profile or low profile 0.1 ml PCR tube, strip, non-skirted, and semi-skirted 48-well plate
Block Temperature	
Block Temperature Range	4.0 – 100 °C
Maximum Heating/Cooling Rate	5.0/3.0 °C/sec
Average Heating/Cooling Rate	2.8/1.5 °C/sec
Accuracy	+/-0.3 °C
Uniformity	+/-0.4 °C
Adjustable Ramping Rates	Yes, 0.1 – 5.0 °C/sec
Gradient Temperature	
Gradient Direction	Increase in the vertical direction
Gradient Temperature Range	30 ~ 100 °C
Gradient Temperature Difference	Max. span 30 °C
Software	
Portability of Protocols	Save and transfer to another TurboCycler via USB flash drive
Stored Program No.	> 4000 sets
Registered User Folder No.	100 sets
User Folder Password Protection	Yes
Run Status Report	Yes, HTML output and transfer via USB flash drive
Real-Time Temp. Profile Export	Yes, CSV output and transfer via USB flash drive
Tools	TM calculator, Copy number calculator, Mastermix preparation calculator
General	
Display	10.1" color LCD with capacitive touch panel
Data Ports	1 USB A front port for USB flash drive
Heated Lid	35 – 130 °C or off
Auto Restart after Power Outage	Yes
Footprint Dimensions (H x W x D)	236 mm x 356 mm x 362 mm
Weight	13 kg
Power Supply	AC 100-240V, 50/60 Hz, 1000 W
Standard	CE

Appendix B: Template Protocols

2-Step

Stage 1	94 °C, 5 min
Stage 2 30 cycles	94 °C, 30 sec
	67 °C, 30 sec
Stage 3	72 °C, 7 min
Stage 4	4 °C, Hold

3-Step

Stage 1	94 °C, 5 min
Stage 2 30 cycles	94 °C, 30 sec
	55 °C, 30 sec
	72 °C, 30 sec
Stage 3	72 °C, 7 min
Stage 4	4 °C, Hold

Gradient

Stage 1	94 °C, 5 min
Stage 2 30 cycles	94 °C, 30 sec
	Gradient 55~70 °C, 30 sec
	72 °C, 30 sec
Stage 3	72 °C, 7 min
Stage 4	4 °C, Hold

Time Increment

Stage 1	94 °C, 5 min
Stage 2 30 cycles	94 °C, 30 sec
	65 °C, 30 sec
	72 °C, 30 sec (+1sec/Cycle)
Stage 3	72 °C, 7 min
Stage 4	4 °C, Hold

Touch down

Stage 1	94 °C, 5 min
Stage 2 30 cycles	94 °C, 30 sec
	60 °C (-0.5°C/Cycle), 30 sec
	72 °C, 30 sec
Stage 3 30 cycles	94 °C, 30 sec
	45 °C, 30 sec
	72 °C, 30 sec
Stage 4	72 °C, 7 min
Stage 5	4 °C, Hold

DOMINIQUE DUTSCHER SAS

Appendix C: CE Declaration



BLUE-RAY BIOTECH CORP.

5F., No.2, Aly.2, Siwei Ln., Zhongzheng
Rd., Xindian Dist., New Taipei City
23148, Taiwan (R.O.C.)

Declaration of Conformity

Product Name: TurboCycler 3

Model Names: TCTT-4810

All models comply with the following European standards:

EMC: EN 61326-1

Safety: EN 61010-1 and EN 61010-2-010

To the best of my knowledge and belief, these units conform to these standards.

Name: Jimmy Kuo

Position: Quality Assurance Manager

Issue Date: 2024. 01. 04

Appendix D: Order Information

Cat. No.	Description
TCTT-4810	Gradient Thermal Cycler with Three Independent Blocks
TCTT-a001	Tube Frame
TCTT-a002	5 mm Compression mat x 3

DOMINIQUE DUTSCHER SAS

DOMINIQUE DUTSCHER SAS

Blue-Ray Biotech Corp.

5F., No.2, Aly.2, Siwei Ln., Zhongzheng Rd., Xindian Dist., New Taipei City 23148, Taiwan
(R.O.C.)

www.blue-raybio.com

P/N: 401-T3BR00-10