



HERASAFE 2030i

MAXISAFE 2030i

Safety cabinets

Operating instructions

50155215 Rev. B 21st September 2021

Copyright 2021

These operating instructions are protected by copyright. Rights resulting thereof, particularly reprint, photomechanical or digital postprocessing or reproduction, even in part, are only allowed with the written consent of Thermo Electron LED GmbH. This regulation does not apply to reproductions for in-plant use.

Trademarks

Herasafe and Maxisafe are registered trademarks of Thermo Electron LED GmbH. All other trademarks mentioned in the operating instructions are the exclusive property of the respective manufacturers.

GPL (General Public License)

Some of the device software includes open-source software, which has been published under GPL, LGPL or another open source license. They include LGPLv2, zlib License, Apache 2.0 License and BSD License. The source texts (Material-No. 50156490) of the software can be obtained from Thermo Fisher Unity Lab Services.

Thermo Electron LED GmbH
Robert-Bosch-Straße 1
D - 63505 Langenselbold
Germany

Thermo Electron LED GmbH is a subsidiary company of:
Thermo Fisher Scientific Inc.
168 Third Avenue
Waltham, MA 02451
USA

DOMINIQUE DUTSCHER SAS

Table of Contents

Chapter 1 General Notes	1
General Safety Instructions.....	2
Warranty.....	3
Explanation of Symbols.....	3
Symbols used in the Operating Instructions.....	3
Symbols on the Device.....	5
Use of the Device.....	7
Intended Use.....	7
Non-intended Use.....	8
Chapter 2 Delivery	9
Items supplied.....	9
Acceptance Inspection.....	9
Transport Lock and Device Packaging.....	9
Chapter 3 Installation of the Device	11
Ambient Conditions.....	11
Room Ventilation.....	12
Correct Location.....	12
Installation in Series.....	12
Connections.....	13
Power Receptacles.....	13
Transport.....	14
Chapter 4 Unit Description	15
Overall View.....	15
Safety System.....	18
Filter System.....	20
Controls and Display.....	22
Sample Chamber Access.....	23
Device Interfaces.....	25
UV Lamp Unit.....	28
Working Area.....	29
SmartPort.....	29
Chapter 5 Start-up	31
Initial Operation.....	31
Installing Unit and Accessories.....	31
Leveling the Device.....	35
Power Supply Connection.....	36
Initial Setup.....	37
USB Interface.....	41
Installation Test.....	41
Chapter 6 Operation	43
Screen Layout.....	43
Info & Health Status Area.....	44

Main Screen (Region R2)	44
Control Panel (Region R2B)	47
Main Navigation Bar (Region R3)	49
Working Mode	50
Startup Mode	51
Standby Mode	51
Cleaning and Loading Mode	52
Idle Mode	53
Sleep Mode	53
Handling and Control	54
Using the auxiliary Rocker Switch	54
Moving the Front Window to the Working Position	55
Lowering the Front Window	56
Switching the Sample Chamber Illumination on and off	56
Activating and Deactivating the internal Power Supply Receptacles	56
Activating and deactivating the internal Gas Supply	57
Logging into a Passcode-protected Unit	57
Logging in	58
Logging out	59
Running UV Disinfection	59
Starting the UV Disinfection Cycle	61
Turning the Fan on and off during UV Disinfection	62
Restarting a disrupted UV Disinfection Cycle	64
Alarms	65
Silencing and Handling Alarms	67
Alerts	68
Handling Alerts	70
Viewing General Status Information	70
Settings	73
Setting UV Disinfection Cycle Time	74
Display Settings	77
Activating / Deactivating Sleep Mode	82
Programs	86
Alarms and Alerts	91
Data Plate	97
Connectivity	98
Firmware Update	112
Access Control	112
Factory Settings	113
Field Certification	113
Event Log	114
Viewing the Event Log	116
Filtering the Event Log	116
Exporting the Event Log	117
Chapter 7 Preparation	121
Hygiene Preparations for the Sample Chamber	121
Preparing the Sample Chamber	121
Response to Failure Messages	122

Work Rules	122
Chapter 8 Shut-down	125
Interrupting an Operation	125
Shutting the Unit down	125
Chapter 9 Cleaning and Decontamination	127
Decontamination Procedure	127
Wipe/Spray Disinfection	127
UV Disinfection after a Wipe/Spray Disinfection	129
UV Disinfection using the integral UV Lamps	129
Changing the UV Disinfection Time	129
Disinfection with Formaldehyde	129
Cleaning the exterior Surfaces	130
Cleaning the Front Window	130
Cleaning the Drain Pan	130
Chapter 10 Maintenance	131
Inspection	131
Service	131
UV Lamps	131
Sample Chamber Illumination	132
Replacing the Front Cover Seal	132
Exchanging SmartPorts	133
Retrofitting and Repairs	133
Chapter 11 Disposal	135
Disposal Procedure	135
Chapter 12 Technical Data	137
Chapter 13 Device Log	145
Chapter 14 Certificate of Decontamination	147
Appendix: City Time Zones	149

DOMINIQUE DUTSCHER SAS

Figures

Figure 1 Correct Location.....	12
Figure 2 Lift Points	14
Figure 3 Overall View, Herasafe 2030i version	15
Figure 4 Overall View, Maxisafe 2030i version	17
Figure 5 Filter System with Downflow Filter and Exhaust Air Filter	20
Figure 6 Filter System with Prefilters, Downflow Air Filters and Exhaust Air Filters.....	21
Figure 7 Controls and Display.....	22
Figure 8 Access through Front Cover	23
Figure 9 Access through Front Window.....	24
Figure 10 Supply Interfaces	25
Figure 11 Workspace Illumination.....	27
Figure 12 UV Lamp Unit.....	28
Figure 13 Working Area on the Workplate, Armrests.....	29
Figure 14 Stand Installation.....	32
Figure 15 Installing the Maxisafe 2030i version.....	34
Figure 16 Initial Startup: Startup Screen.....	37
Figure 17 Initial Setup: Setting the Language	37
Figure 18 Initial Setup: Setting the Region.....	38
Figure 19 Initial Setup: Setting the Date	38
Figure 20 Initial Setup: Setting the Time of Day in 12hr, AM/PM Format	39
Figure 21 Initial Setup: Setting the Time of Day in 24hr CET Format	39
Figure 22 Initial Setup: Completing the Initial Setup.....	40
Figure 23 Main Screen - Unit in Standby Mode, Window Closed.....	40
Figure 24 USB Interface and Display.....	41
Figure 25 Screen Areas	43
Figure 26 Info & Health Status Area.....	44
Figure 27 Main Screen	45
Figure 28 Overview of Side-View Symbol Graphics for Unit Status	46
Figure 29 Control Panel for fully equipped Unit.....	47
Figure 30 Control Panel for Unit without Gas Option.....	48
Figure 31 Buttons on the Control Panel.....	49
Figure 32 Tooltip Bubble over “Close window” Button.....	49
Figure 33 Main Navigation Bar	50
Figure 34 Main Screen - Unit working.....	50
Figure 35 Main Screen - Unit starting up	51
Figure 36 Main Screen - Unit in Standby.....	51
Figure 37 Main Screen - Unit cleaning	52
Figure 38 Main Screen - Unit in Idle Mode, Window closed	53
Figure 39 Main Screen - Unit in Idle Mode, Window open	53

Figure 40 „Tap to wake“ Screensaver.....	54
Figure 41 Basic window functions of the auxiliary Rocker Switch.....	54
Figure 42 Info & Health Status Area with “Login” Prompt.....	57
Figure 43 “Login” Screen	58
Figure 44 “Log out” Screen	59
Figure 45 “Log out” Screen: Logged out Message.....	59
Figure 46 Main Screen: “UV disinfection” running	60
Figure 47 Main Screen: Disinfection running with Adjustment for Bulbs	60
Figure 48 UV Cycle Alert when “Light Bulb” Button is tapped during UV Disinfection.....	61
Figure 49 Tooltip Bubble over “Close window” Button.....	61
Figure 50 UV Cycle Alert when Window is open / Illumination is on.....	61
Figure 51 UV Disinfection Cycle complete Alert	62
Figure 52 Reduced Flow Mode Alert during UV Disinfection Cycle	63
Figure 53 “Fan” Button in Off Mode vs UV Disinfection Mode	63
Figure 54 “Fan” Button in UV Disinfection Mode vs Off State.....	63
Figure 55 UV Disinfection Cycle was disrupted Alert	64
Figure 56 Alarming Screen for Downflow too high and too low Alarm	65
Figure 57 “Health Status Alarm” Icon (“Alarm Bell”) in unsnoozed and snoozed Modes.....	66
Figure 58 Alarming Screen with snoozed Alarm	66
Figure 59 “Health Status Alarm” Screen	67
Figure 60 Main Screen after two Cycles of Alarm Ticker Message	67
Figure 61 “Alert” Screen with Filter Replacement Reminder	68
Figure 62 “Status Alert” Screen with Alert Screen Message, Status Alert GFI	69
Figure 63 Main Screen after two Cycles of Alert Ticker Message.....	69
Figure 64 “GFI tripped” Alert Details Screen.....	70
Figure 65 “Status Good” Screen #1: Operating Hours, UV and Filter	71
Figure 66 “Status Good” Screen #2: Operating Hours, UV and Filter (EU Version)	72
Figure 67 “Status Good” Screen #2: Filter, Power Consumption and Air Speed	72
Figure 68 “Settings“ Screen	73
Figure 69 “Disinfection Cycle Settings” Screen	74
Figure 70 “Settings Saved” Pop-up Windows for Disinfection Cycle Settings	76
Figure 71 “Display Settings” Screen	77
Figure 72 “Display Settings” Screen: “Language” Screen	79
Figure 73 “Display Setting” Screen: “Date” Screen.....	80
Figure 74 “Display Setting” Screen: “Time” Screen with 12-hour AM/PM Format.....	81
Figure 75 “Display Setting” Screen: “Time” Screen with 24-hour Format.....	81
Figure 76 “Sleep Mode” Dropdown Menu	82
Figure 77 “Units” Dropdown Menu	82
Figure 78 “Display Settings” Screen: “Unit Name” Screen	83
Figure 79 “Display Settings” Screen: “Unit Name” Screen	84

Figure 80 “Display Setting” Screen: “Menu Bar Customization” Screen with Icon Swapping Options..... 85

Figure 81 “Display Setting” Screen: “Region” Screen 86

Figure 82 “Programs” Screen 87

Figure 83 “Programs” Screen: “Edit AutoStart” Screen..... 88

Figure 84 “Programs” Screen: “Edit AutoStop” Screen 89

Figure 85 “Alarms and Alerts” Screen 91

Figure 86 “Alarms and Alerts” Screen: “Alarm Volume” Options..... 92

Figure 87 “Alarms and Alerts” Screen: Window Alarm Tone Options 92

Figure 88 “Alarms and Alerts” Screen: Airflow Alarm Tone Options 93

Figure 89 “Alarms and Alerts” Screen with Snooze Timeout Options expanded 94

Figure 90 “Alarms and Alerts” Screen: Alert Volume Options 94

Figure 91 “Alarms and Alerts” Screen: Alert Tone Options 95

Figure 92 “Settings Saved” Screen..... 95

Figure 93 “Changes not Saved” Message 96

Figure 94 “Data Plate” Screen 97

Figure 95 “Data Plate” Screen: “Contact Us” Screen 97

Figure 96 “Data Plate” Screen: Editing the “Contact Us” Screen..... 98

Figure 97 “Connectivity” Screen..... 99

Figure 98 “Connectivity” Screen with Network Name Displayed..... 100

Figure 99 “WiFi” Screen 100

Figure 100 Screen with Network Connection Message 101

Figure 101 “WiFi” Screen with Password Required..... 102

Figure 102 Network Connection Message..... 103

Figure 103 “WiFi” Screen - Join Other 103

Figure 104 “Thermo Fisher Cloud” Screen..... 107

Figure 105 Thermo Fisher Cloud Connection Successful Message 109

Figure 106 “Connect via Passcode” Screen 110

Figure 107 „WiFi Connection Error“ Screen 111

Figure 108 “Access Control” Screen in “Open” Mode..... 112

Figure 109 “Access Control” Screen in “Secure” Mode 113

Figure 110 “Event Log” Screen..... 114

Figure 111 “Event Log” Screen: Standby Mode expanded..... 116

Figure 112 Filtering the “Event Log” 117

Figure 113 “Export log” Screen: Missing USB Drive Alert 118

Figure 114 “Export in progress” Screen..... 118

Figure 115 “Export log” Screen: Export completed 119

Figure 116 Sitting Posture 123

Figure 117 Replacing the Front Cover Seal 132

DOMINIQUE DUTSCHER SAS

General Notes

The following are the addresses of the international Thermo Sales Organisations.

Postal address Germany

Thermo Electron LED GmbH
Robert-Bosch-Straße 1
D - 63505 Langenselbold

Enquiries from Germany

Phone

Sales 0800 1 536376
Service 0800 1 112110

Fax

Sales/Service 0800 1 112114

E-Mail

info.labequipment.de@thermofisher.com

Enquiries from Europe, Middle East and Africa

Tel. + 49 (0) 6184 / 90-6940
Fax + 49 (0) 6184 / 90-7474

Enquiries from North America:

Phone +1 800-879 7767 +1 800-879 7767
Fax +1 828-658 0363

Enquiries from Latin America:

Phone +1 828-658 2711
Fax +1 828-645 9466

Enquiries from Asia Pacific:

Phone +852-2711 3910
Fax +852-2711 3858

E-Mail

info.labequipment@thermofisher.com

General Safety Instructions

These safety instructions describe the safety features of the Herasafe 2030i and Maxisafe 2030i series.

The safety cabinet has been manufactured in keeping with the latest technological developments and has been tested before delivery for its correct function. It may, however, present potential hazards if it is not used according to the intended purpose or outside of operating parameters. Therefore, the following procedures must always be observed:

- The safety cabinet must be operated only by trained and authorized personnel.
- For any operation of this unit, the operator must prepare clear and concise written instructions in the language of the operating and cleaning personnel based on these operating instructions, applicable safety data sheets, plant hygiene guidelines, and technical regulations, in particular:
 - which decontamination measures are to be applied for the cabinet and accessories,
 - which protective measures apply while specific agents are used,
 - which measures are to be taken in the case of an accident.
- Repairs to the device must be carried out only by trained and authorized expert personnel.
- The contents of the operating instructions are subject to change without further notice.
- Concerning translations into foreign languages, the English version of these operating instructions is binding.
- Keep these operating instructions close to the unit so that safety instructions and important information are always accessible.
- Should you encounter problems that are not detailed adequately in these operating instructions, please contact Thermo Electron LED immediately for your own safety.

Use this product only in the way described in the product literature and in this manual. Before using it, verify that this product is suitable for its intended use. If the equipment is used in a manner not specified by the manufacturer, the protection provided by the equipment may be impaired.



Your unit must be properly grounded in conformity with national and local electrical codes. Do not connect the unit to overloaded power sources.



Disconnect the unit from all power sources before cleaning, troubleshooting, or performing other maintenance on the product or its controls.

Warranty

Thermo Electron LED warrant the operational safety and functions of the safety cabinet only under the condition that:

- the device is operated and serviced exclusively in accordance with its intended purpose and as described in these operating instructions,
- the device is not modified,
- only original spare parts and accessories that have been approved by Thermo Electron LED are used,
- inspections and maintenance are performed at the specified intervals,
- an installation test is performed prior to the initial operation of the device and that a repeat test is performed on the occasion of all inspections and repairs.

The warranty is valid from the date of delivery of the device to the operator.



Any changes or modifications not expressly approved by Thermo Scientific could void the user's authority to operate the equipment.

Explanation of Symbols

Symbols used in the Operating Instructions



Is used if non-observance may cause serious or even lethal injuries.



This symbol, in the context of a CAUTION, indicates a potentially hazardous situation which if not avoided could result in minor to moderate injury or damage to the equipment.

NOTE

is used for hints and useful information.



Valuable raw materials can be reused.



This symbol when used alone indicates important operating instructions which reduce the risk of injury or poor performance of the unit.



This indicates a situation which may result in property damage.



Before installing, using or maintaining this product, please be sure to read the manual and product warning labels carefully. Failure to follow these instructions may cause the product to malfunction, which could result in injury or damage.



This symbol indicates possible pinch points which may cause personal injury.



During movement of the front window do not try to access the inner chamber.



The use of Gas burner is not recommended.



UV lamps only be activated if front window is completely closed.

DOMINIQUE DUTSCHER SAS

Symbols on the Device

Observe operating instructions (cover of electrical box)



Biohazard (left device front)



USB interface

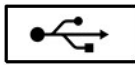

The European voltage models of this product meet all the applicable requirements of the European Directives and therefore display the CE Marking. The most current EU Declaration of Conformity may be obtained from the manufacturer.



GS sign - TÜV Nord



Cytostatic agents are plant-derived or synthetic substances that can cause death or inhibit growth and dividing of a cell.



Filter replacement

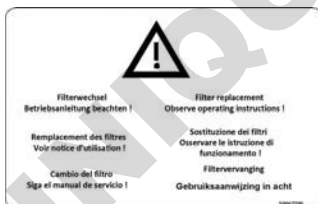

2 x T5A outlet fusing

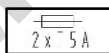

2 x T 15 AH



2 x T 16 AH Equipment Fusing



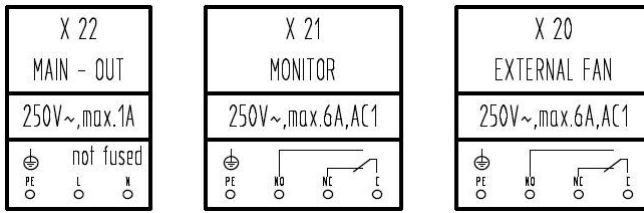

X20 connection for an external fan
 X21 connection for a solenoid valve
 X22 connection for an external component

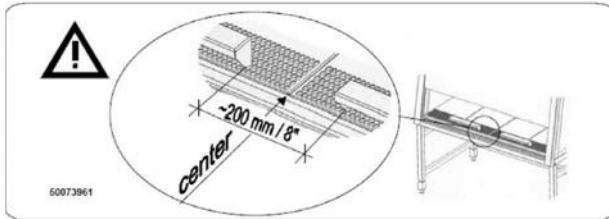

Armrest installation



UV lamp

This equipment is FCC listed

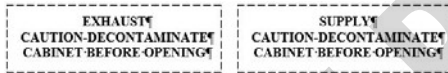

Exhaust and supply lines

DOMINIQUE PUTSCHER SAS

Use of the Device

Intended Use

Herasafe 2030i version:

The safety cabinet is a laboratory device for installation and operation in microbiological and biotechnical laboratories of safety levels 1, 2, and 3. It has been designed as a Class II microbiological safety cabinet, in accordance with EN 12469:2000.

Depending on the hazard level of the agents involved, the operator must prepare in writing appropriate decontamination procedures for the device and the accessories used in the sample chamber.

Following media should be used:

- Vacuum (Rough vacuum 10 E-2 bar / 0,145 psi)
- Combustible gas (e.g. Propane)
- Non-combustible gas (e.g. Nitrogen)

Maxisafe 2030i version:

The safety cabinet also conforms with the requirements of the DIN 12980:2016, allowing it to be used in the production of cytostatic agents.

For cytostatics applications, use only the one-piece, low-profile workplate.

Before the device is taken into service for the first time, the operator must perform an installation test and document the results in a test record. The device may only be released for production use if it conforms with the operating parameters specified by Thermo Electron LED.

Whenever changes to the installation conditions or modifications to the technical system have been made, the operator must perform a repeat test and keep a complete record thereof to document that the device conforms with the operating parameters specified by Thermo Electron LED.

Non-intended Use

The safety cabinet must not be used in laboratories that do not comply with the requirements of safety levels 1, 2, and 3.

The unit must not be operated as a Class II safety cabinet if:

- no repeat test is performed after changes to the installation conditions or after modifications to the technical system.
- the alarm system of the device has issued a failure message and the cause for the failure has not been repaired.

The alarm system must not be tampered with or disabled. If alarm system components have been removed or disabled for service or repairs, the unit must only be released for operation if all alarm system components are functioning again properly.

The filters installed in the device are not capable of separating gaseous substances. Therefore, do not work with or store substances in the device:

- are toxic which in quantity or concentration,
- if a reaction with other substances may result in hazardous toxic concentrations or formation of toxic gases,
- that may form combustible or explosive mixtures in combination with air.

Delivery

Items supplied

Delivery for the safety cabinet includes the following:

Herasafe 2030i version:

- safety cabinet
- armrests

Maxisafe 2030i version:

- safety cabinet
- armrests
- stand

All versions:

- device documentation with:
 - operating instructions (CD)
 - factory test report
 - summarized safety instructions (SSI)
 - HEPA filter certificate

Optional components and accessories are listed as separate items in the delivery document.

Acceptance Inspection

After the device has been delivered, immediately check the device:

- for completeness,
- for possible damage.

If the delivery is incomplete or if you detect any transport damage to the device, contact the forwarding agency and Thermo Electron LED immediately.

Transport Lock and Device Packaging

Do not transport the device over large distances without transport lock and original device packaging.

DOMINIQUE DUTSCHER SAS

Installation of the Device

Ambient Conditions

The operational safety and correct function of the unit depend on the location where it is to be operated. The safety cabinet must be operated only at locations that meet the ambient conditions listed below.

Location requirements:

- The electrical system of the device has been designed for an operating height of up to 2,000 m above sea level.
- The mains power supply outlets should be out of casual reach to prevent accidental shut-off. Ideally, the outlets should be installed above the safety cabinet and be readily accessible.
- The flooring of the location must be adequately strong and not flammable.
- The support frame must be designed with an adequate load-carrying capacity (supporting four times the weight of the device).
- The room in which the device is installed must be of adequate height. For units not connected to an exhaust system, the distance between the exhaust air opening and the room ceiling must be at least 200 mm. There is potential to install with a lower clearance of 200mm. This should be discussed with a Thermo Fisher Scientific BSC specialist.
- The location must be equipped with an appropriate ventilation system, see “Room Ventilation” on page 12.
- The temperature within the room must be between 10 °C and 40 °C.
- The power supply voltage should not vary by $\pm 10\%$ from its nominal value.
- Transient overvoltage peaks shall not exceed the usual range prevailing within the AC power supply grid. The nominal transient overvoltage level shall be the surge withstand voltage according to overvoltage category II of IEC 60364-4-443.
- An appropriate ground fault circuit interrupter must be installed by the customer to protect the device system.
- Condensation must be avoided, for example, subsequent to relocation or transport. Should condensation exist, wait for the humidity to evaporate completely before connecting to a power source or powering up the device.
- The relative humidity in the vicinity of the device must not exceed 90 %.

NOTE Ambient conditions

If ambient conditions vary from those described above, please contact Thermo Electron LED for assistance in installing the device.



Temporary storage

If the device is stored only temporarily (up to four weeks), the ambient temperature must be between -20 °C and +60 °C (-4 °F and +140 °F) at a relative air humidity of up to 90 %. For longer storage periods, the location requirements apply.

Room Ventilation

The room ventilation should preferably be a ventilation system that complies with the national requirements for the application.

- The inlet air and exhaust air openings of the room ventilation must be located so that drafts are prevented from impairing the function of the safety cabinet air system.

Correct Location

Choose a draft-free location where the safety cabinet does not interfere with the plant traffic.

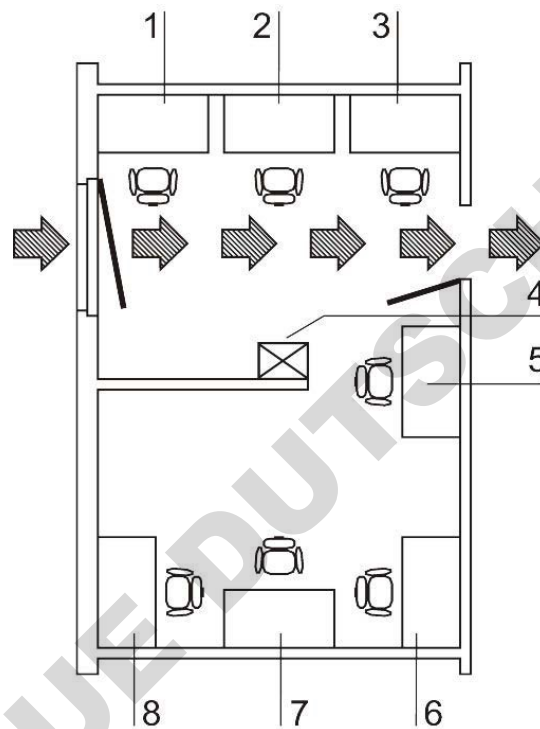

Figure 1 Correct Location

This figure shows preferred locations for safety cabinets and unsuitable locations, not in accordance with the safety requirements.

Unsuitable locations: The locations [1], [2] and [3] are not suitable because they are exposed to drafts from windows and doors.

Location [5] is undesirable because it is in range of plant traffic and within the exhaust air range of a ventilation system [4].

Preferred locations: Preferred locations [6], [7], and [8] are correct because they are in a draft-free section of the room and not exposed to plant traffic.

Installation in Series

When several devices are to be installed in series, please observe the following:

- Make sure that vibrations cannot be transferred between adjacent units,
- exterior surfaces of the cabinets must always be accessible for cleaning and disinfection,
- minimum distance of 2 m (6.6 ft.) between workbenches on opposite position.

Connections

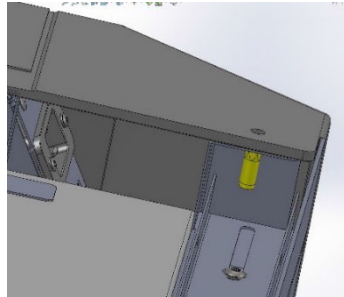

Power cable

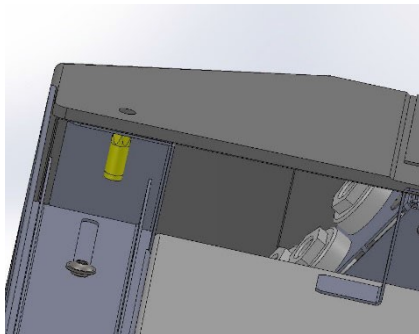

X22 X21 X20



Cable glands allow for connecting up to 3 external devices.
 Connect directly to the printed circuit board!
 Caution! Make sure the max. current output is not exceeded!

X 22	X 21	X 20
MAIN - OUT	MONITOR	EXTERNAL FAN
250V~,max.1A	250V~,max.6A,AC1	250V~,max.6A,AC1
<p>not fused</p>		

X22 230V Power Supply / X21 Monitor Alarm / X20 External Fan
 The leads can be attached on the outer face of the anti-tilt anchor using cable ties.

Power Receptacles



Both power receptacles are fused using a T 5A slow-blow fuse.

Transport

Version Herasafe 2030i:

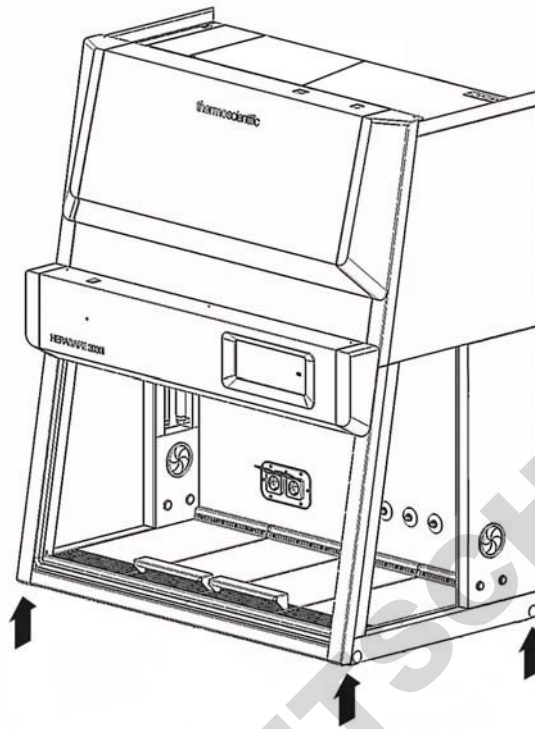

Figure 2 Lift Points

To prevent tilting, always transport the device using a suitable carrier, even for a transport within a building, and separate it from the stand.



Danger of tipping over!

For transport, lift the device only using the lift points shown in the illustration. Do not load the drain pan with the weight of the device frame!



Contusion hazard!

When lifting the safety cabinet, do not put hands or fingers between drain pan and frame!

Maxisafe 2030i version:

If required, the body must be separated from the stand and be reinstalled on the stand prior to the initial operation of the device (see "Installing Unit and Accessories" on page 31).

Unit Description

Overall View

Herasafe 2030i version:

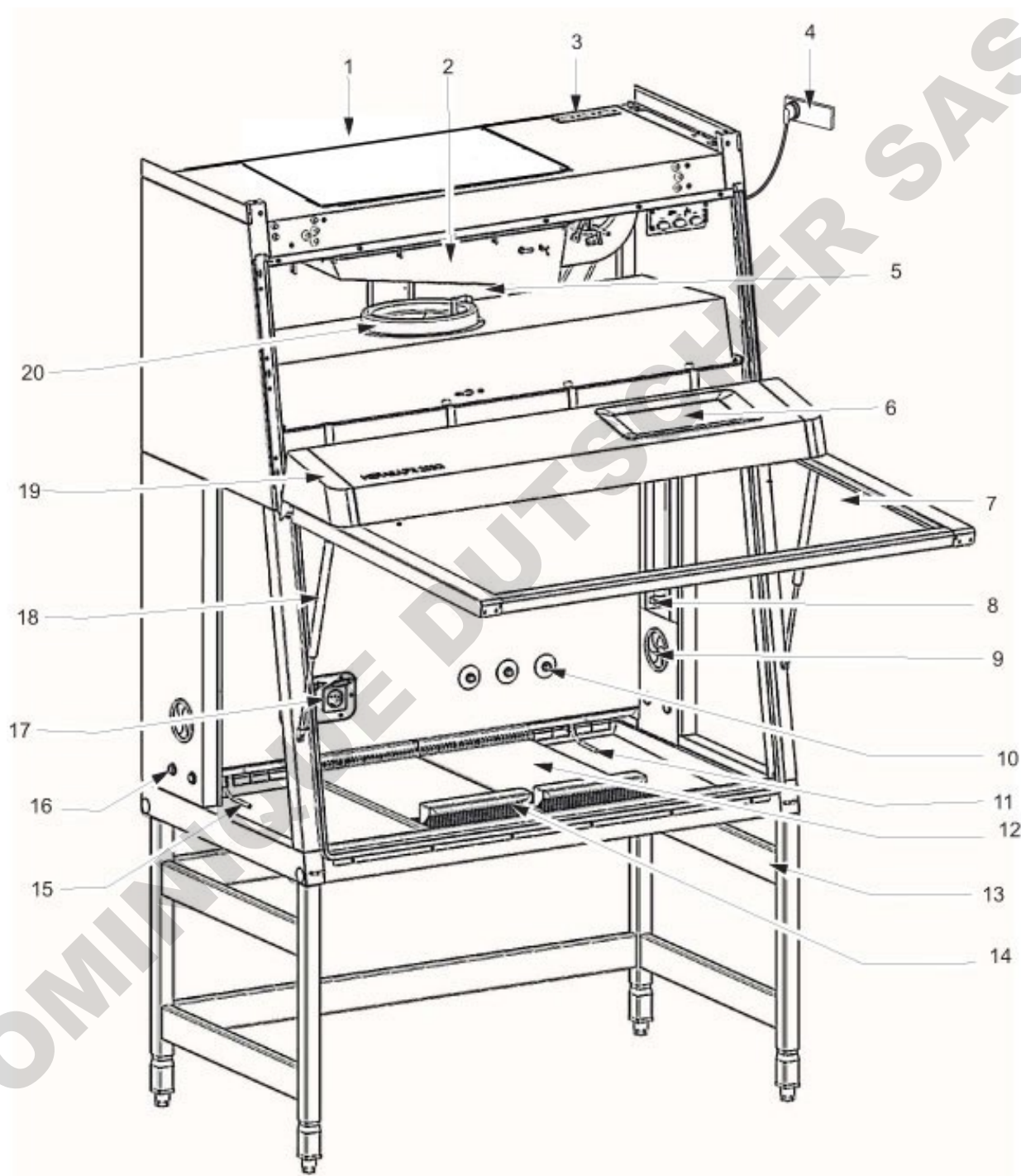

Figure 3 Overall View, Herasafe 2030i version

- Plenum assembly [5] with plenum for downflow fan [20] and plenum for exhaust air fan [2]. The downflow filter and the exhaust air filter are installed directly to the pertaining fan. The exhaust air is released into the environment around the device through the opening [1].

- At the top side of the plenum, the optional media supply lines [3] are routed into the sample chamber [10].
- Power supply cable [4].
- Front cover [19] with integral, electrically movable front window [7]. An auxiliary rocker switch for basic BSC window operation is located on the top left of the light dome.
The gas struts [18] secure the front cover in the open state.
- The light dome [19] with two tubes is part of the front cover assy.
- Side slates with two sealed access openings [16]. These can be equipped with media valves.
- SmartPorts [9] for introducing tubing into the sample chamber.
- Internal outlets [17] for power supply of accessories.
- Optional UV lamp unit [8] consisting of two UV lamps per side.
- Optional stands [13], adjustable in height and with fixed height.
- Workplate segments [12] with arm rests [14]. A one-piece workplate and special work plates are available options.
- GUI Operating Panel [6] with cabinet controls, alarm system indicators, and cabinet status display. A USB connection to download data log is installed at the GUI display [6].
- Test hoses for the supply unit [15] at the left side of the workspace and for the exhaust unit [11] at the right side of the workspace.



Test hoses

Do not remove the two test hoses for checking downflow and exhaust air.

Maxisafe 2030i version:

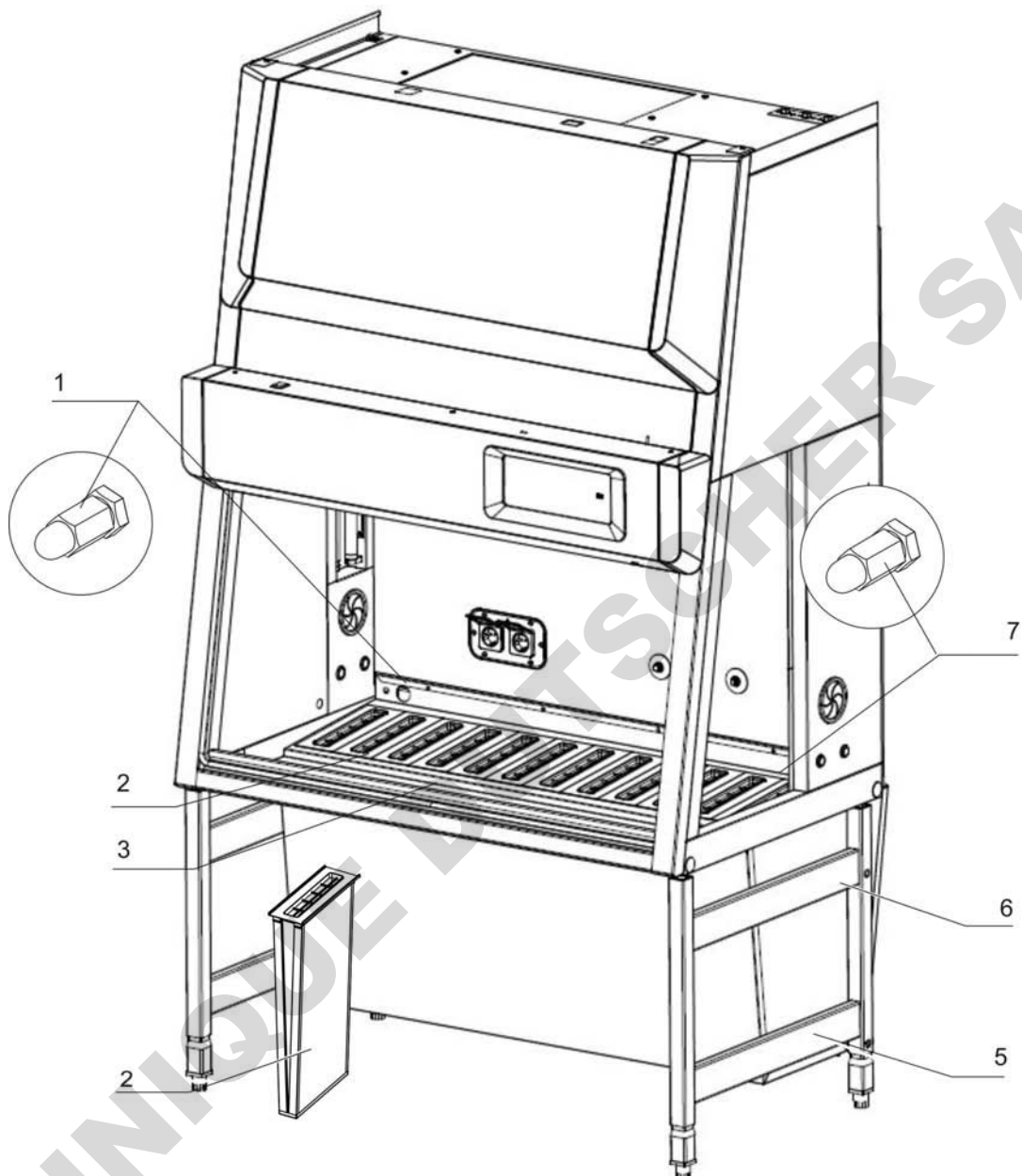

Figure 4 Overall View, Maxisafe 2030i version

- Figure 4: Stand [5] with built-in prefilter casing [6].
- Filter cartridges [2] for installation in prefilter casing. The number of filter cartridges supplied with the device depends on the overall width of the unit. To prevent the accumulation of fluid residues, the filter cartridges are arranged at a slight angle to the rear wall of the unit to form a drain channel towards the drain pan [3]. The filter cartridges [2] are sealed with tape.
- Membrane grommet or orifice for filling with aerosol for filter test on downflow fan unit [1] on the left side of the workspace and exhaust fan unit [7] on the right side of the workspace.

Safety System

The safety system comprises a combination of protective and alarm systems that ensure maximum personal and material protection.

Safety systems:

- **Vacuum-sealed air system**

An air system in combination with HEPA filters for downflow and exhaust air forms the basis of the safety system for personal and material protection.

- **Personal protection**

Air aspirated from the exterior along the entire working opening at a constant high speed prevents that:

- agents may leak through the working opening of the chamber.

As the exterior air pressure around the unit exceeds the pressure of the internal air system, it is ensured that:

- agents cannot be released to the exterior in the case of a leak in the cabinet housing.

- **Product protection**

A steady airflow within the air system ensures that:

- a constant downflow allows the HEPA filters to remove contaminants so that the samples are always surrounded by ultrapure air,
- harmful particles are not carried over through the sample chamber (protection from cross-contamination).

- **HEPA filters**

The downflow (i.e. the air circulating within the device) and the exhaust air (air that is released to the exterior) are cleaned by HEPA filters (HEPA = High Efficiency Particulate Air Filter).

- **Safety lockout**

To protect from UV radiation, the optional UV disinfection routine can be run only if the front opening is closed. During UV disinfection, the front opening safety lockout is activated and prevents harmful UV radiation from being emitted from the sample chamber.

- Media connections and components are to be installed by expert personnel only.

Warning system:

- **Airflow monitoring**

Airflow monitoring determines the speed of the airflow in the sample chamber as well as the inflow speed of the air aspirated from the exterior through the working opening. As soon as air speeds move above or below a specified safety value, a signal is transmitted to the alarm system.

- **Visual and audible alarm system**

The warning system constantly monitors the safety-relevant device functions:

- inflow speed of the air aspired from the exterior,
- downflow speed,
- working position of the front window.

If the warning system detects changes to one of these device functions, it issues:

- an audible and a visual alarm signal.

- **Position monitoring**

The position sensors monitor the position of the front window; it will indicate when the front window is in the working position.

DOMINIQUE DUTSCHER SAS

Filter System

Version Herasafe 2030i

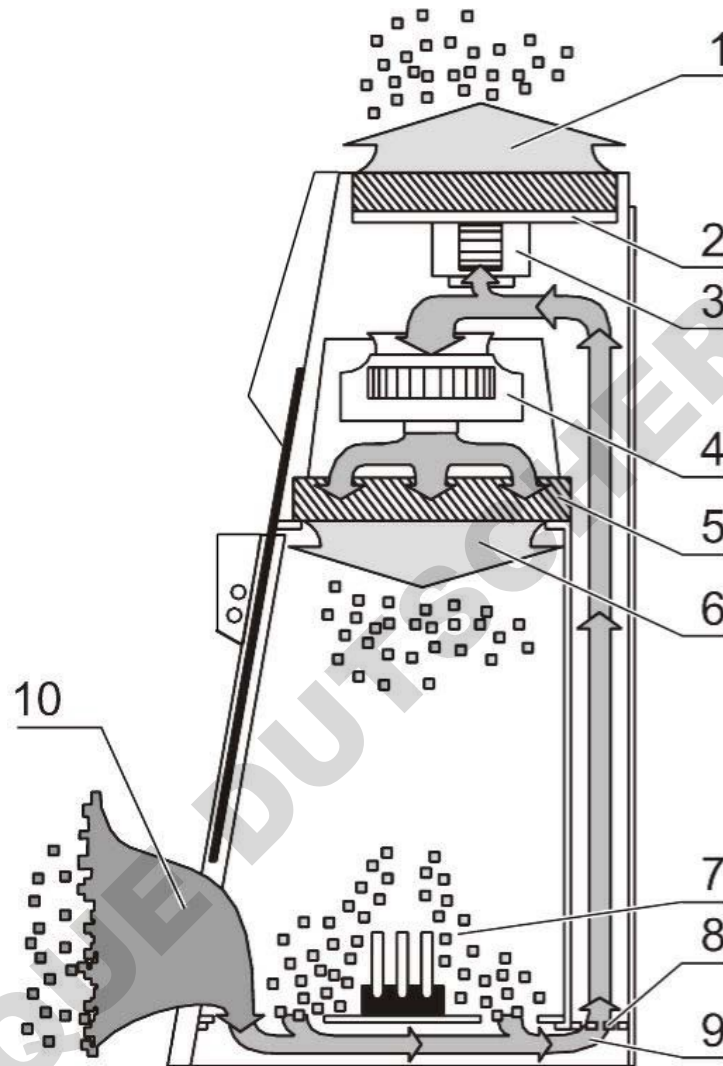

Figure 5 Filter System with Downflow Filter and Exhaust Air Filter

The filter system consists of two HEPA filters [2] and [5] for the circulating air and for the exhaust air and a coarse filter for the aspired air.

HEPA filters: Room air [10] is drawn into the sample chamber through the working opening. In the air duct, room air and the downflow within the chamber [7] are then blended to make up the blend air [9]. The blend air is then:

- filtered proportionally by the downflow filter [5] and supplied as ultrapure air [6] evenly into the sample chamber of the device,
- filtered by the exhaust air filter [2] and released as ultrapure air [1] to the exterior of the device.

Inlet air protection: The air duct between the sample chamber and the device plenum has an inlet air protection [8] below the working surface to prevent coarse particles from entering the plenum where they may impair fan [3] and [4] and filter functions.

Maxisafe 2030i version

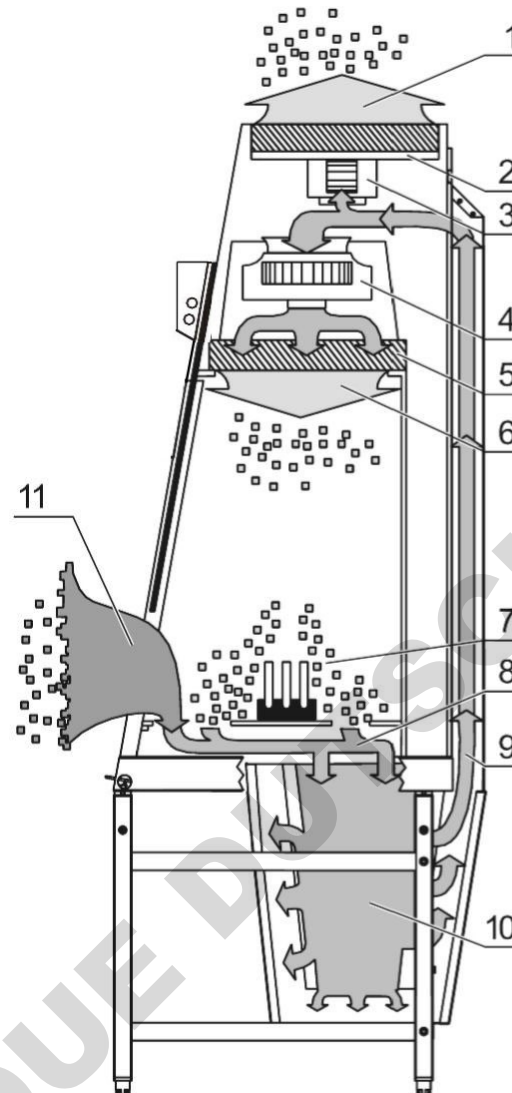

Figure 6 Filter System with Prefilters, Downflow Air Filters and Exhaust Air Filters

The filter system consists of a set of HEPA prefilters [10] (the number of filters depends on the overall width of the workspace) and two HEPA filters [2] and [5] for the downflow and exhaust air flow.

HEPA Prefilter:

Due to the compact size of the filter cartridges, filter replacement can be achieved with minimum contamination. The use of prefilters relieves the workload on the downflow and exhaust filters considerably.

The filter cartridges used are Class H14 HEP filters (to DIN EN 1822). Alternatively, activated carbon filters can be inserted into the casing as odour filters.

Ambient air [11] is drawn in through the working opening. In the intake area above the prefilter, ambient air and exhaust air from the device [7] mix to form blend air [8]. This blend air is then:

- drawn into the prefilter [10], then filtered and channeled to the air duct [9].

HEPA Filter: From the air duct, the prefiltered air is then:

- filtered proportionally by the downflow filter [5] and supplied as ultrapure air [6] evenly into the sample chamber of the device,
- filtered by the exhaust air filter [2] and released as ultrapure air [1] to the exterior of the device.

Controls and Display

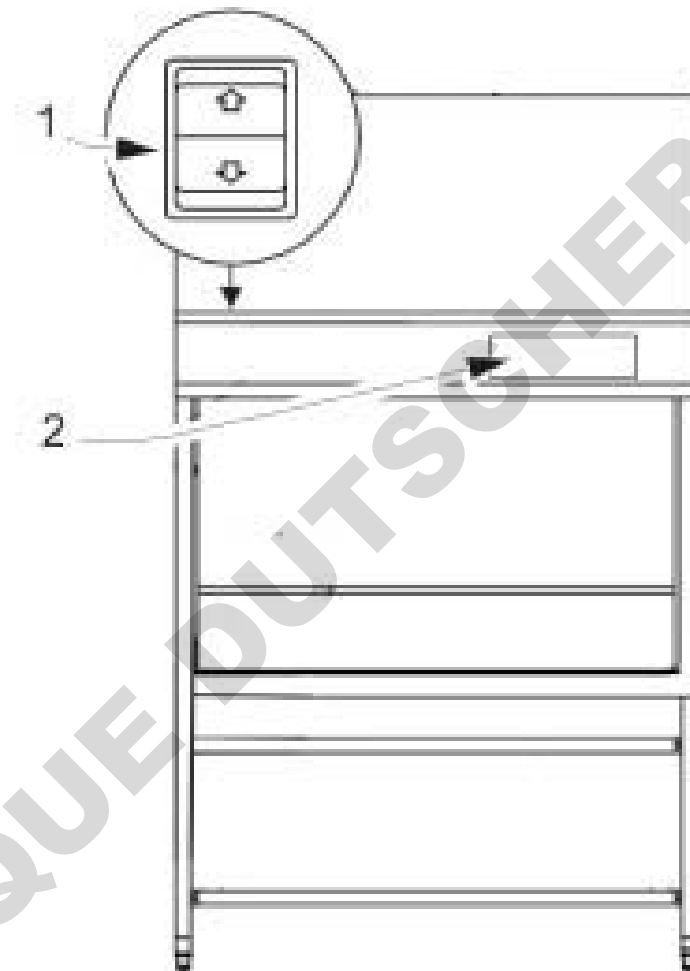

Figure 7 Controls and Display

The safety cabinet is equipped with two separate control elements that operate independently of each other:

- auxiliary rocker switch [1] to move the front window up and down
- GUI - Graphical User Interface [2]

The status indicators of the display [2] indicate control operations initiated with the control elements.

In the GUI the current status of the cabinet is shown.

Sample Chamber Access

The sample chamber of the device is accessible via two modes.

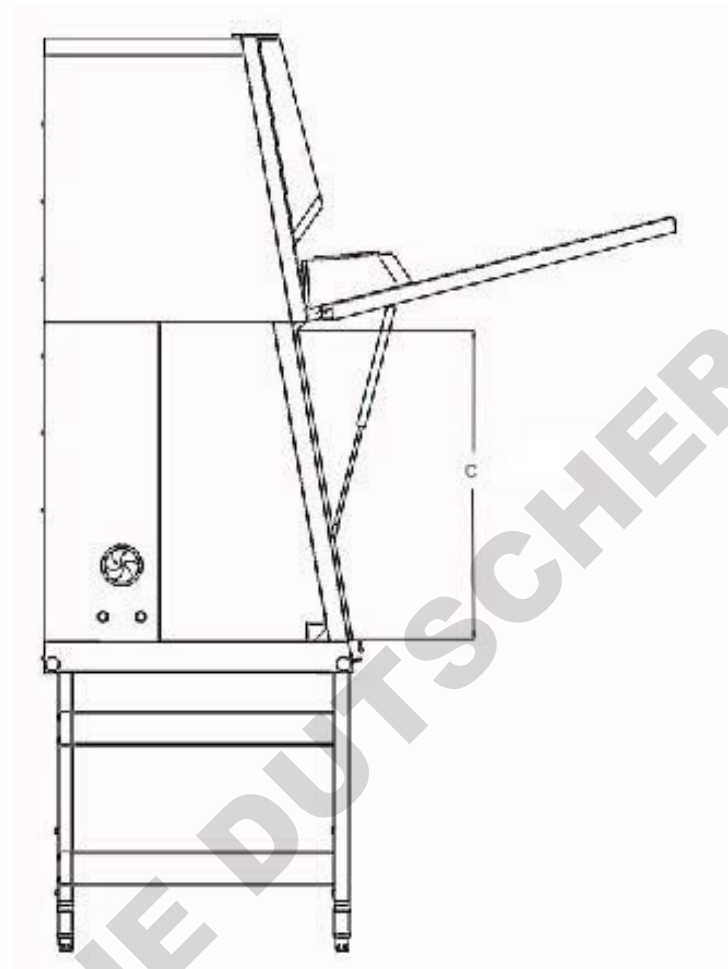

Figure 8 Access through Front Cover

Front cover:

Manual opening of the front cover [1] allows access to the complete sample chamber width with an opening height C. It is generally needed for decontamination and introduction of larger accessories.

NOTE Front cover lockout

The front cover is equipped with a safety lockout and can only be opened in standby mode, i.e. when the front window is completely closed.

A - minimum working opening
 B - maximum opening height

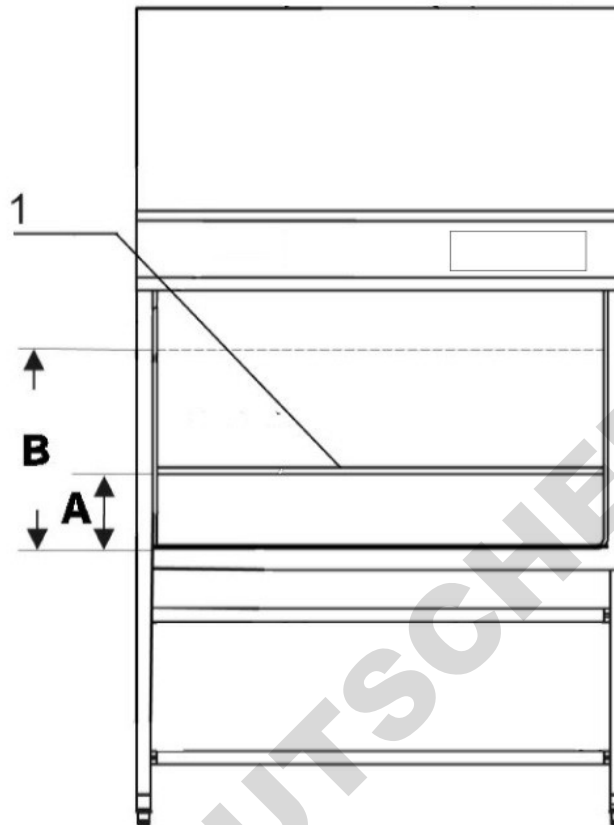

Figure 9 Access through Front Window

Front window:

The electrically operated front window [1] is made of multi-layer safety glass and integral to the front cover frame. It can be raised to a maximum opening height B. To access the sample chamber during the work process, the front window must stay in the work position with opening height A.



Crushing hazard

During movement of the front window do not try to access the inner chamber.



Front window movement!

Do not attempt to move the front window manually as otherwise the motor drive may be damaged.

Lowering the front window when the device is deenergized:

The safety feature is backed up by a battery. Should a power failure occur, the auxiliary rocker switch (see "Using the auxiliary Rocker Switch" on page 54) can be used to lower the front window completely.

Device Interfaces

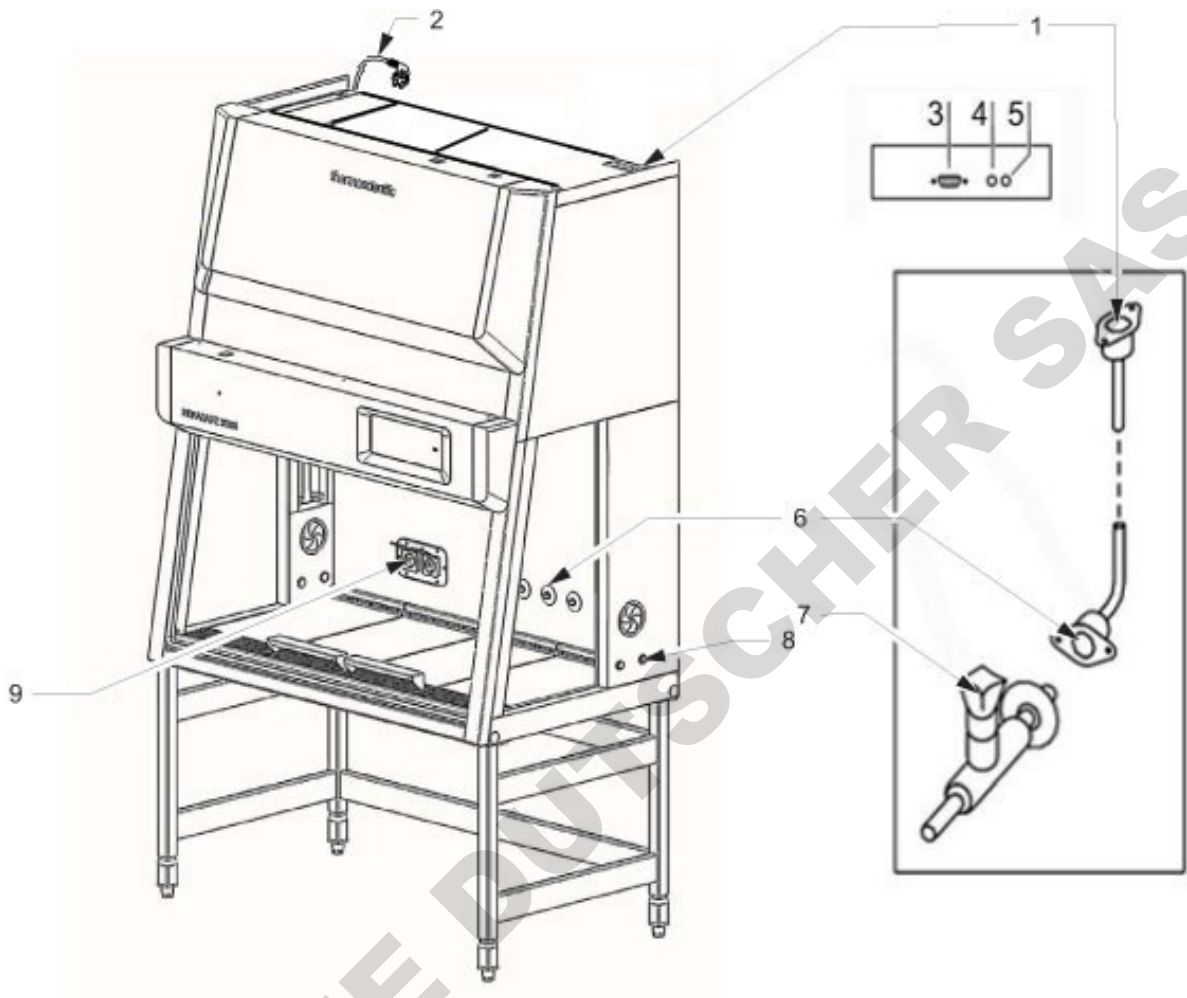

Figure 10 Supply Interfaces

The standard equipment includes the outlets [9] for internal power supply as well as the SmartPort and openings [8] on both sides for routing of cables and hoses. All other supply connections are available as options and may also be retrofitted.

Power supply connection: The connection to the power supply system is achieved through a cable with grounding plug [2].

Contact: At the top side an USB interface [3] for Service is installed. Two fuse holders for 5A miniature fuses are located at the top rear of the cabinet:

[4] for L-Phase,
[5] for N-Neutral.

Internal power supply: According to the model size there are electrical outlets at the left or/and right side (5A) [9] located on the rear wall.

Feed throughs: There are two sealed feed throughs [8] on each side. These may be used for installation of media valves [7]. On delivery they are sealed with plastic stoppers.

Media connections (optional): The media supply unit consists of three pipes that are routed into the sample chamber through the top of the unit. The inlet connections [1] and outlet connections [6] with thread (R 3/8"), e.g. for media valves [7], are preinstalled and equipped with a sealing plug.

The media connections are universal-type connections. One equipotential bonding connection is installed at the top of the unit.

NOTE

The connection of the piping and media valves has to be carried out according to country specific standards and by expert personnel only.

**Combustible gas!**

The use of a gas burner is not recommended.

If a gas burner is to be operated in the sample chamber, then a low profile burner should be used and an appropriate shut-off device for the gas supply system (shut-off valve, solenoid valve) must be installed.

Use only laboratory safety burners in the sample chamber.

External systems: Failure detection systems or gas supply solenoid valves may be connected to the safety cabinet control.

Workspace Illumination

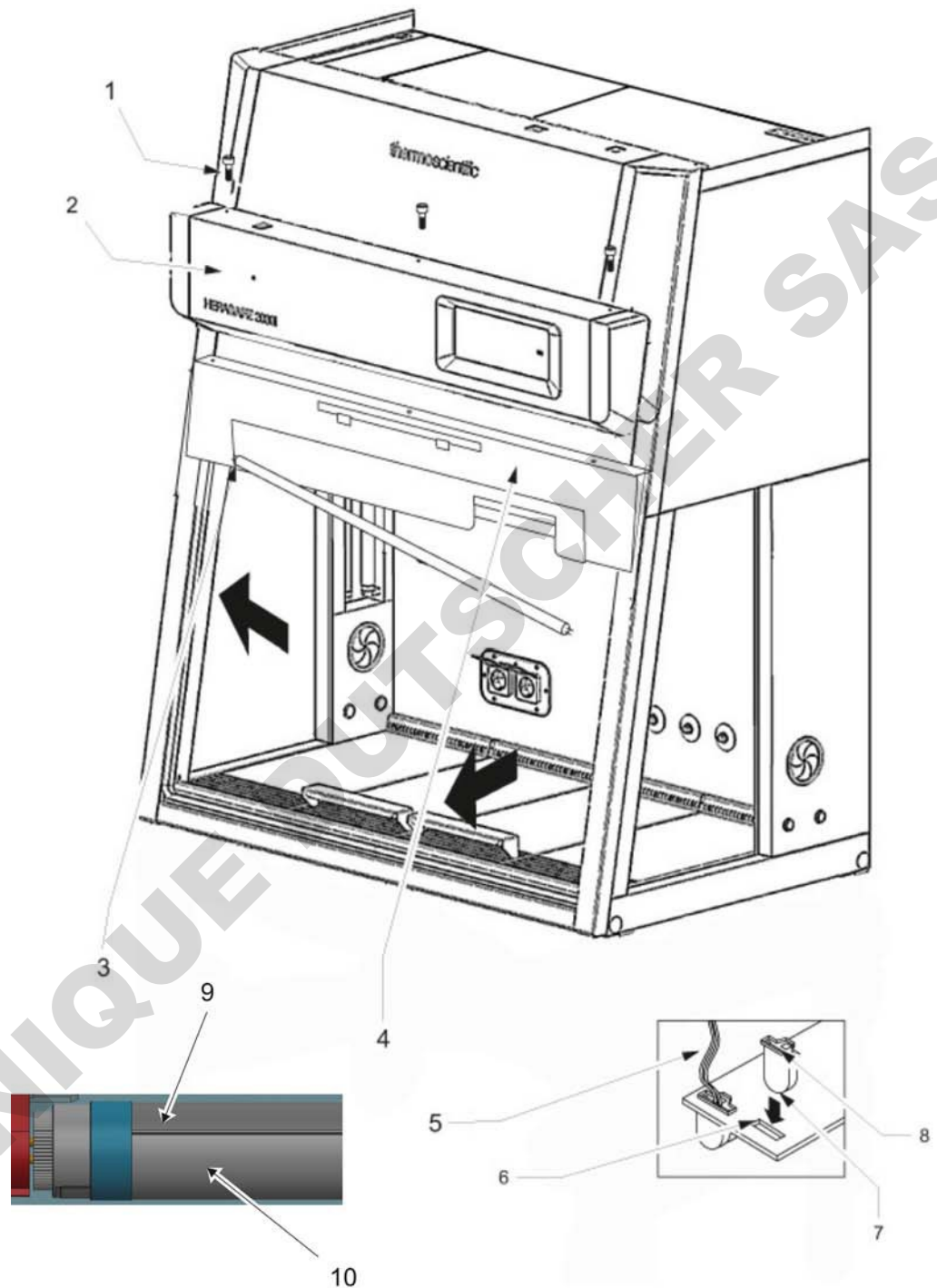

Figure 11 Workspace Illumination

The workspace illumination [2] is equipped with two LED that are installed behind the light dome [3].

NOTE

The reflector side (9) must be installed upwards, so that the radiation side (10) is fully active.

UV Lamp Unit

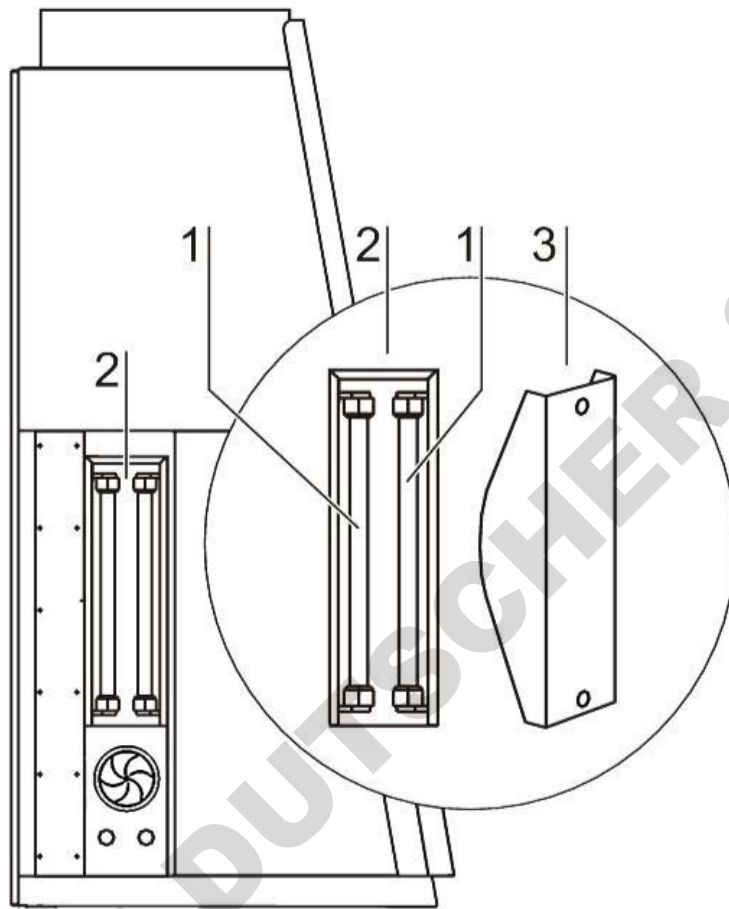

Figure 12 UV Lamp Unit

The UV lamp unit consists of two lamp housings [2] with two UV lamps each [1] that are integral to the side walls. Both lamp housings are protected by a stainless steel cover [3].

By cross-radiation of the UV units, all surfaces will be disinfected as the shadow zone is reduced. The operating time of the UV lamps is preset and can be changed by the operator.

NOTE Protection from UV radiation

As a protection from harmful UV radiation, the UV lamps can only be activated if the front window is completely closed.

Working Area

The standard equipment comprises the segmented workplate for the Herasafe 2030i and the one-piece workplate for the Maxisafe 2030i. Special workplates are available as optional accessories.

The workplates or workplate segments are placed onto the frame above the workspace drain pan.

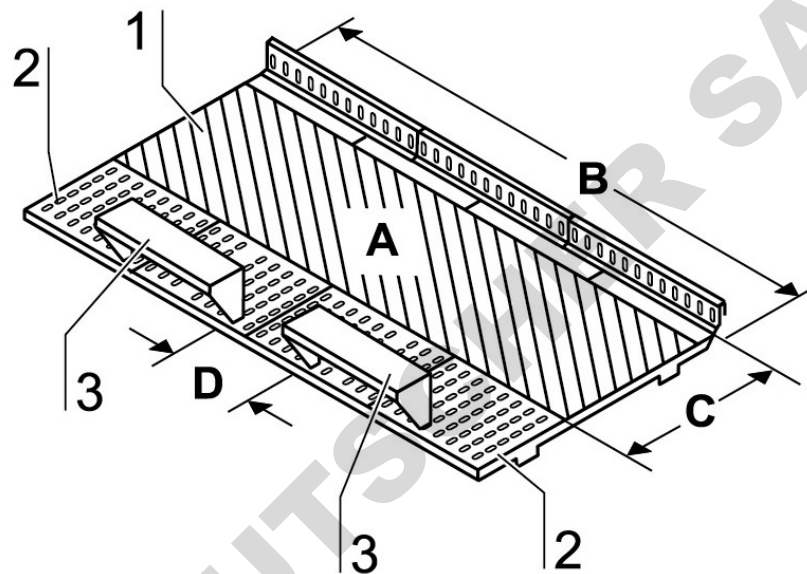

Figure 13 Working Area on the Workplate, Armrests

The working area A for perfect material protection extends over the entire width B and depth C of the workplate [1]. The two arm rests [3] are positioned at a distance D (20 cm) to each other centrally on the workplate [1] or on the workplate segments. The armrests are installed to the second perforation line [2] of the workplate.



The 2 armrests (3) are safety relevant component parts!

SmartPort

Installation of low voltage cables and hoses:

The low voltage cables and hoses that are used must be designed for the purposes intended. Hoses have to be < 10 mm (Ø 10 mm). The opening in the rubber grommet of the SmartPort should be maintained as small as possible so as not to compromise the efficiency of containment. Always introduce hoses from the outside inwards and apply only little force. Make sure that the seal is seated correctly! The SmartPort is intended for single use and may not be reused.

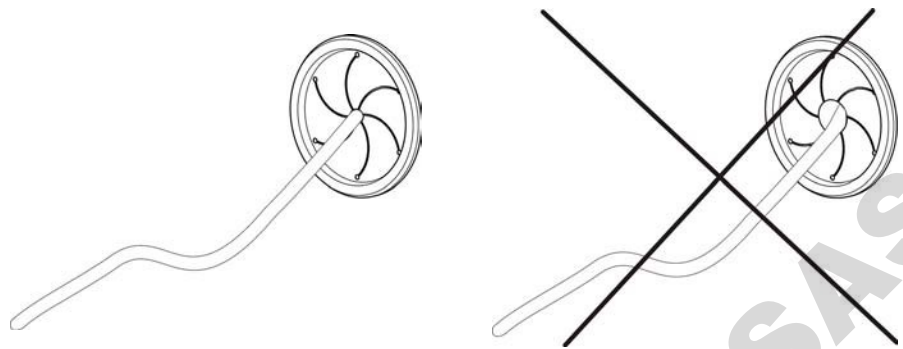

Models with NF label!

Any deviation from the installation instructions for low-voltage cables or tubing through the access port constitutes a non-compliant use of the NF. Such action will, in the event of an accident with biohazardous materials, result in the complete loss of the manufacturer's liability. For the warranty conditions, please see section 1.4 and 1.5 Standards and safety regulations.



Containment!

If feedthrough seals previously pierced are not used in operation, new seals must be installed in order to ensure a stable vacuum in the workspace. The correct seating of the SmartPorts in the side walls must be verified.

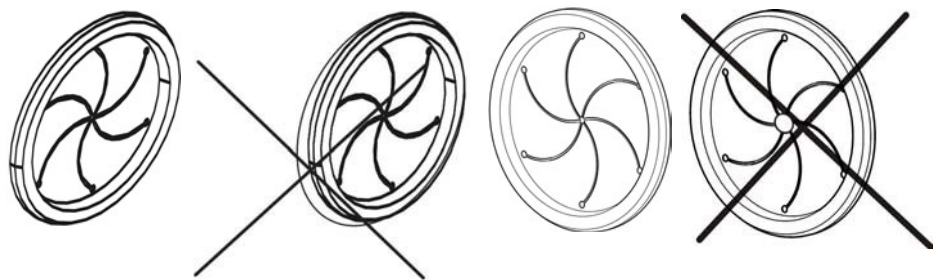

Start-up

Initial Operation

Prior to initial operation, the safety cabinet must be subjected to an installation test. Correct assembly and installation performed by the operator are essential for good start-up.

Installing Unit and Accessories

Herasafe 2030i version:

Device without stand:

- Place the device without stand onto a sufficiently stable substructure so that the weight of the device frame does not rest upon the drain pan.



High lever load!

Depending on the size, the units have a weight of 170 kg to 280 kg, see Technical data.

Lift the unit with an appropriate lifting device.

- Remove the protective foil from the worktops and arm rests.

Device with stand:

To assemble the (optional) stand and to install the device frame to the stand:



Figure 14 Stand Installation

1. Slide the two crossmembers [2] onto the retaining angles [3] of the sidemembers [1]. Secure the crossmembers to the two sidemembers using the screws [4].

2. To attach the device frame [5] to the stand [7], install four Allen screws [6] loosely into the corresponding threaded holes at the underside of the device.
3. Place the safety cabinet [1] onto the stand so that the Allen screws [6] pass through the corresponding holes [8] of the retaining tabs [10].
4. Push the device frame [5] in the grooves [9] of the retaining tabs [10] all the way to the stop.
5. Tighten the four Allen screws [6].

DOMINIQUE DUTSCHER SAS

Maxisafe 2030i version:

The stand [3] and prefilter casing [1] form a mechanical unit. To facilitate the installation of the body, the stand is equipped with a lifting device.

The four columns [7] of the stand have built-in spindles [6], on which the body can be placed and lowered to its final position.

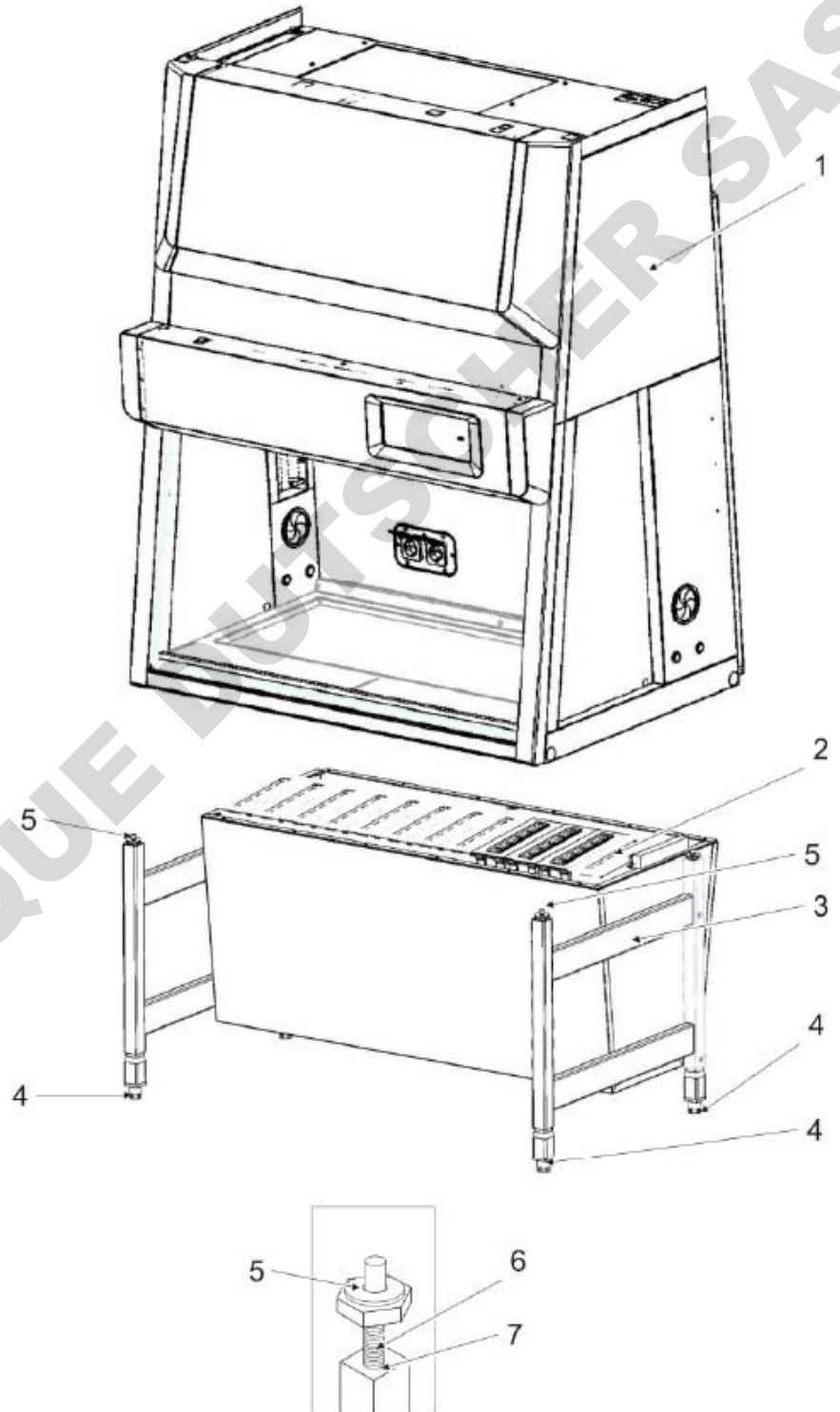

Figure 15 Installing the Maxisafe 2030i version

1. Extend the spindles by approx. 10 cm by turning the respective hexagon heads [5] and adjust the spindles to the same height on all four columns.
2. Place the safety cabinet on the spindles. Check whether the guide pins [4] fit exactly in the receptacles on the lower frame of the body.
3. Screw in the spindles evenly and in small steps until the hexagon heads butt against the column heads.



Leveling the device

Never use the spindles to level the device, but use the adjustable levelers instead.

4. To level the working area of the safety cabinet, place a bubble level on the workplate and turn the levelers [2] at the bottom of the stand with a wrench (size: 24 mm) until the workplate is exactly level in all directions. When adjusting the device levelers, you should proceed from left to right and from rear to front.

Leveling the Device

The cabinet should be levelled only after it has been positioned.

1. Remove transport protection (foil) from the workplate or from the workplate segments.
2. Lift the workplate or the workplate segments and place it/them onto the front and rear rails in the sample chamber with the wide line of holes facing forward.
3. Device without stand: Place a bubble level onto the workplate and align the substructure until the bubble level indicates an exactly horizontal position in all directions.
4. Device with a stand: Place a bubble level onto the workplate and use the four levellers to effect a level state in all planes.
When adjusting the device stand height, proceed from right to left and from rear to front.

Power Supply Connection



High voltage!

Contact with current-carrying components may cause a lethal electric shock.

Before connecting the device to the power supply system, check plug and power supply cable for possible damage. Do not use damaged components to connect the device to the power supply system!

The connection has to be carried out according to country specific standards.

Establishing the power supply connection:

1. Before connecting the device to the power supply system, check to see if the voltage of the outlet corresponds with the specifications on the nameplate of the device. If the ratings given for voltage (V) and maximum current (A) are not correct, the device must not be connected to the power supply system.
2. Connect the grounding plug of the device to a properly grounded and fused outlet.
 - The outlet must be fused separately using a fusible link T 16 A or using a circuit breaker B 16.
3. Make sure that the power supply line is not subjected to tensile or compressive force.

Installation of the power supply connection:

To protect against accidental switch-off, the outlets for the connection to the power supply must be located outside the normal hand reaching range and must be accessible only to authorized personnel. Ideally, the outlets should be installed above the safety cabinet and be readily accessible. Route the power cables so they do not run across hot surfaces (such as exhaust tubing or similar tubing runs).

Connecting the equipotential bonding:

If the sample chamber is supplied with media (gas, water, etc.), the on-site equipotential bonding must be connected to one of the premounted threaded bushings at the top of the housing.

Initialization routine:

After the unit has been connected to the power supply system, the device control runs through a start-up initialization routine.

Initial Setup

This section explains how to set up the device using the initial setup routine.

When the unit is turned on for the first time after delivery to the customer site, you must complete an initial setup process before you can use the unit. There are five single screens with initial adjustments you must make and confirm using the “Next” button to complete the full setup.

On some screens, you may return to the previous screen by tapping the “Back” button. At the top of each screen a step counter shows your progress through the setup routine, indicating the number of the current step and the total number of steps, for example “Step 2 of 5”. A screen title appears directly underneath the step counter to indicate where you are in the setup routine.

Proceed as follows to start up the unit:

1. Power up the device by connecting the external power source.

A startup screen with a “Start Setup” button appears, prompting you to run the setup, as shown in Figure 16 below.



Figure 16 Initial Startup: Startup Screen

2. Tap the “Start Setup” button.

The “Language” screen appears with a wheel picker, prompting you to choose a display language, as shown in Figure 17 below.



Figure 17 Initial Setup: Setting the Language

3. Tap the up/down arrows or swipe your finger across the wheel up or down to set the language (default is English).
4. Once you have chosen your display language, tap the “Next” button.

The next screen allows you to select your location. Enter the name of the city/country and select from the list of suggestions displayed (see “Appendix: City Time Zones” on page 149).

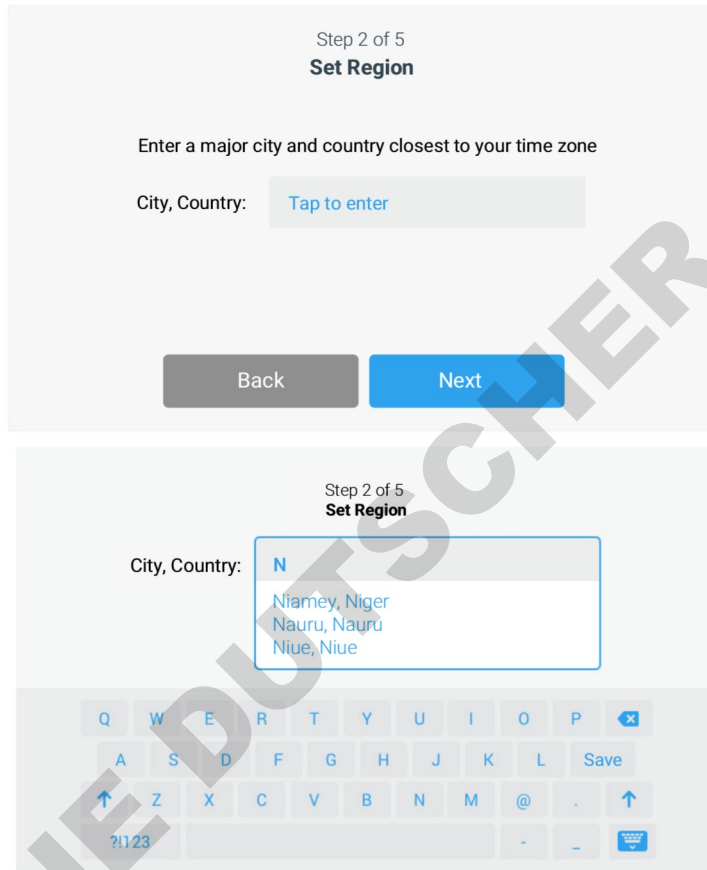

Figure 18 Initial Setup: Setting the Region

After selecting the region, tap the “Save” button.

The “Date setup” screen appears with a wheel picker, prompting you to set the date, as shown in Figure 19 below.

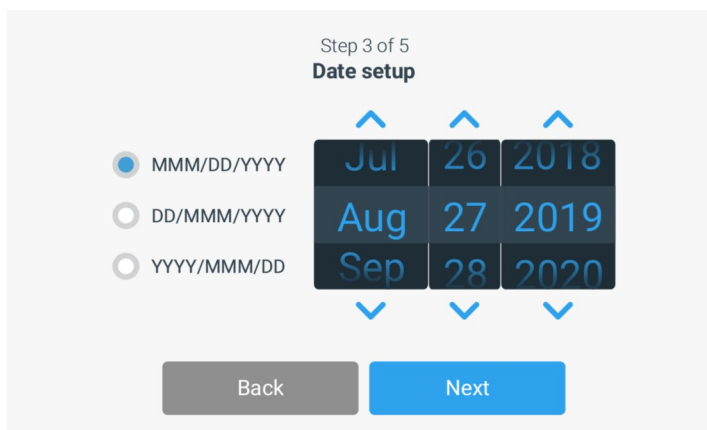

Figure 19 Initial Setup: Setting the Date

5. Tap the “MMM/DD/YYYY”, “DD/MMM/YYYY”, or “YYYY/MMM/DD” radio button on the left side of the screen to choose a date format.

The segments of the wheel picker screen are rearranged to reflect the selected date format. For example, if you select the “DD/MMM/YYYY” radio button, the wheel picker will change to 01 | Jan | 2016.

6. Tap the up/down arrows or swipe your finger across the wheel up or down to set the current month, day, and year on each of the three wheel picker segments.
7. Once you have set the date, tap the “Next” button.

The “Time setup” screen appears with a three-segmented wheel picker, prompting you to set the time of day, as shown in Figure 20 below.

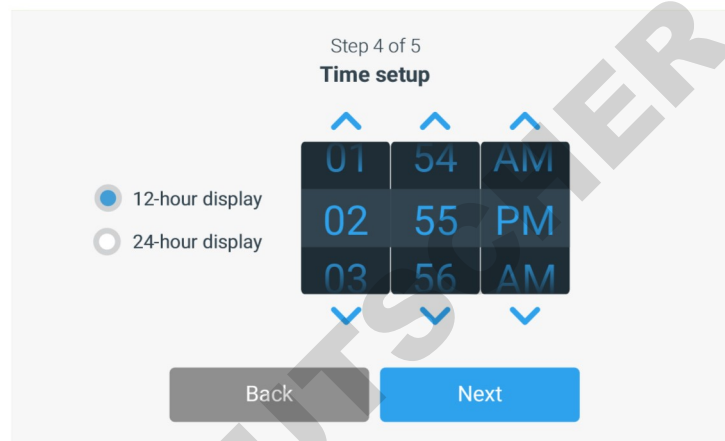

Figure 20 Initial Setup: Setting the Time of Day in 12hr, AM/PM Format

8. If desired, tap the “24-hour display” radio button on the left side of the screen to choose the 24-hour time format. (Default time format is AM/PM, 12-hour format.)

The segments of the wheel picker screen are rearranged to reflect the 24-hour time format, as shown in Figure 21 below.



Figure 21 Initial Setup: Setting the Time of Day in 24hr CET Format

9. Tap the up/down arrows or swipe your finger across each wheel up or down to set the current time in hours and minutes.
10. Once you have set the time, tap the “Next” button.

The “Setup completed” screen appears with its “Finish” button highlighted, prompting you to complete the setup, as shown in Figure 22 below.

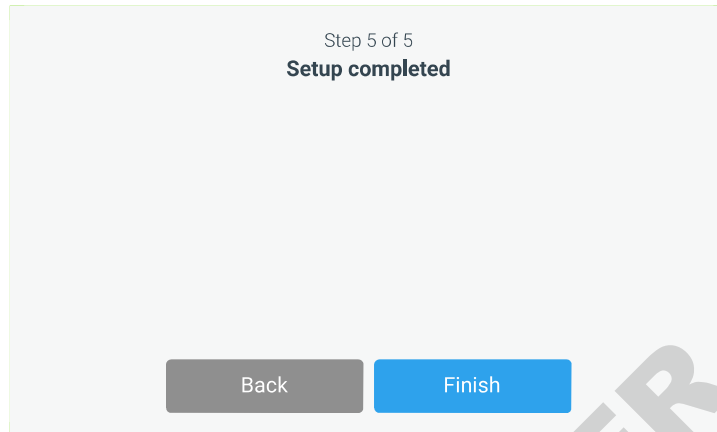

Figure 22 Initial Setup: Completing the Initial Setup

11. Tap the “Finish” button to have your setup stored.

The unit comes up in standby mode, as shown in Figure 23, with the window closed.



Figure 23 Main Screen - Unit in Standby Mode, Window Closed

The Setup is complete now. You can now begin using the unit.

NOTE All of the settings made in the previous steps can be edited by tapping the “Settings” icon in the left-hand Main Navigation Bar. See “Main Navigation Bar (Region R3)” on page 49.

Power supply connection

The safety cabinet should remain connected to the power supply system at all times to ensure that settings for the individual unit configuration remain active in the memory. If the power supply is interrupted for more than 5 minutes, the time must be reset correctly. After the power supply connection has been reestablished, the system switches to the operating mode that had been active last. Additionally, a window with the message “Mains voltage has been restored” appears as soon as power has been restored, prompting the user to confirm by tapping OK. This message may, for example, be caused by a power outage.

USB Interface

The USB port on top of the device is reserved for servicing!



Pin	Name	Description	Level
1	USB_H1_VBUS	Power supply	+5 V DC max 500mA
2	USB_H1_DN	Data minus (D-)	
3	USB_H1_DP	Data plus (D+)	
4	GND	Ground	

Figure 24 USB Interface and Display

The USB port next to the display window enables the user to save log data and install new software releases.

Installation Test

Do not operate the device before the installation test has been completed.

- The installation inspection of the device must be conducted in accordance with EN 12469 and additionally according to DIN 12980 for Maxisafe 2020. The cabinet may be operated as a Class II microbiological safety cabinet, in accordance with EN 12469 / 2000, if the device functions or function patterns listed below were checked and if the test results are within the safety value tolerances specified by the manufacturer:
 - Electrical safety test
 - Inflow speed test
 - Downflow speed test
 - Leakage test of HEPA filters
 - Airflow control test
 - Installation test according to DIN 12980:2016 for Maxisafe 2030i
- A repeat test must also be performed after repairs to the device or after considerable changes (more than 5 cm) to the location of the device.
- The operator must prepare a test report or request a written test report from the authorized test service.



Safety warranty

The operational safety of the device, particularly the personal and material protection, are guaranteed only if all safety functions of the device have been tested and approved.

Thermo Electron LED will not warrant the operational safety if the device is operated without performance of the required installation test or if the installation test and repeat test are not performed by adequately trained and authorized personnel!

NOTE Device hygiene

The initial start-up with subsequent installation test does not include any decontamination measures. For operation in the work process, the sample chamber of the device and the accessories required for the work process must be disinfected and cleaned in accordance with the hygiene guidelines set forth for the application.

DOMINIQUE DUTSCHER SAS

Operation

This chapter describes how to control the Herasafe 2030i and Maxisafe 2030i Biological Safety Cabinets from the touchscreen display mounted in the light dome of the unit.

The screen display unit measures 17.8 cm (7 inches) diagonally across and has touch-sensitive areas that support finger gestures like tapping, swiping and pinching. It can be used with gloves.

Screen Layout

The touchscreen display unit of the Herasafe 2030i and Maxisafe 2030i Biological Safety Cabinets is subdivided into the four main screen regions. Figure 25 presents the arrangement of the screen areas discussed in the following.



Figure 25 Screen Areas

The four screen areas offer the following features:

- The Info & Health Status area (Region 1 in Figure 25 above) shows the biological safety cabinet's name, the current date and time, the unit's overall health status, and a login area when password protection is activated. For an overview, see "Info & Health Status Area" on page 44.
- The Main Screen (Region 2 in Figure 25 above) displays the main operating parameters of the unit, including window status and airflow speeds. When alarms or reportable events occur, this part of the display screen shows alarm or event information. For an overview, see "Main Screen (Region R2)" on page 44.
- The Control Panel (Region 2B in Figure 25 above) offers touch-sensitive buttons for controlling the major functions of the unit, such as window up/down, sample chamber illumination, gas supply, and power receptacles. For an overview, see "Control Panel (Region R2B)" on page 47.
- The Main Navigation Bar (Region R3) holds iconic shortcuts to the "Settings" screen and is visible at all times. Clicking any of these icons displays "Settings" screen in the Main Screen area. For an overview, see "Main Navigation Bar (Region R3)" on page 49.

Info & Health Status Area

The Info & Health Status Area at the top of the display window appears in all screen displays. Figure 26 shows an example of the Info & Health Status Area on a unit that is in a proper working condition.



Figure 26 Info & Health Status Area

The Info & Health Status Area displays the following information:

- Unit Name (top left in Figure 26), see “Setting the Unit Name” on page 83.
- Date/Time (bottom left in Figure 26), as entered during the initial setup (see “Initial Setup” on page 37) or adjusted later on (see “Setting the Date” on page 79 and “Setting the Time of Day” on page 80).
- The “Unit Health Status” icon (center in Figure 26) is a touch-sensitive area that opens a Health Status pop-up window on top of the Main Screen. Four different icons may appear in this place, representing the overall health status of the biological safety cabinet:



The green “Health Status Good” icon indicates that the unit is in proper operating condition. For more details, see “Viewing General Status Information” on page 70.



The yellow alert triangle is a “Health Status Alert” icon. It indicates that there is an issue that does not stop operation of the biological safety cabinet immediately, yet requires the operator’s attention soon, such as a HEPA filter to be replaced. For more details, see “Handling Alerts” on page 70.

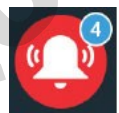

The “red bell” “Health Status Alarm” icon indicates that there are one or more major alarm conditions that need to be corrected because they may constitute a hazard to the operator or the unit itself. The blue circle indicates how many alarms exist. A red bell with sound waves on both sides (top) means that the alarm is sounding, while the red bell with the diagonal line across (bottom) shows that the alarm has been snoozed. For more details, see “Silencing and Handling Alarms” on page 67.



- The “Login” prompt (top right in Figure 26) appears only if the unit is set up to operate in Secure Mode (see “Access Control” on page 112).

Main Screen (Region R2)

The Main Screen takes up the main part of the “Display Settings” screen and displays the status details on the biological safety cabinet.

Figure 27 shows the unit in working mode, with the window ready in the working position and the downflow and inflow speeds at operational speeds. The sample space illumination, fans, gas supply and power receptacle functions are all on.

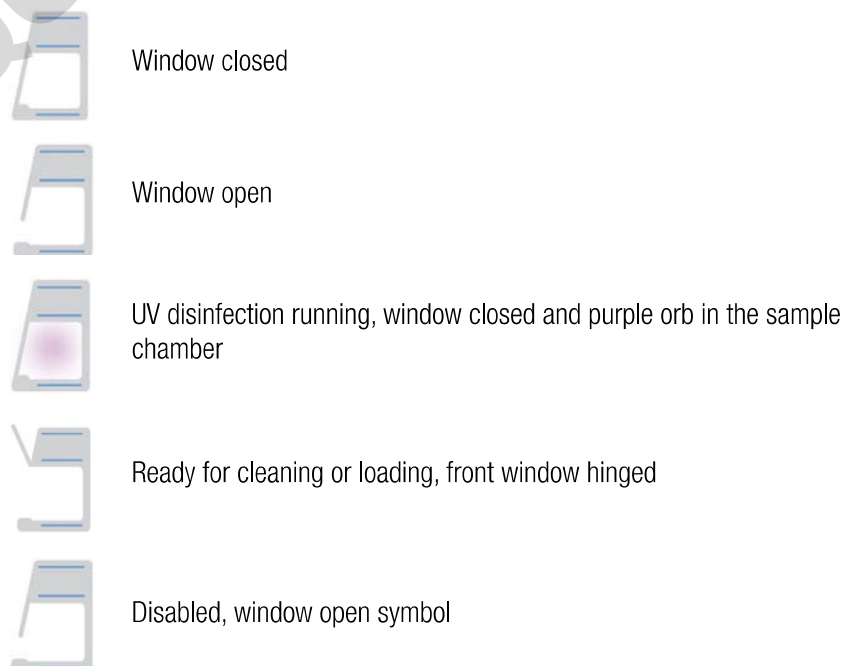

Figure 27 Main Screen

The screen content changes with operational state, depending on whether the unit is:

- in working mode, as shown in Figure 27 above
- starting up, as explained in “Startup Mode” on page 51
- in standby mode, as explained in “Standby Mode” on page 51
- ready for loading and/or cleaning, as explained in “Cleaning and Loading Mode” on page 52
- in idle mode, as explained in “Idle Mode” on page 53
- running UV disinfection, as explained in “Running UV Disinfection” on page 59

The side-view symbol graphic on the left shows the current state of the unit. Figure 28 gives an overview of how the symbol graphic varies with different operational states.



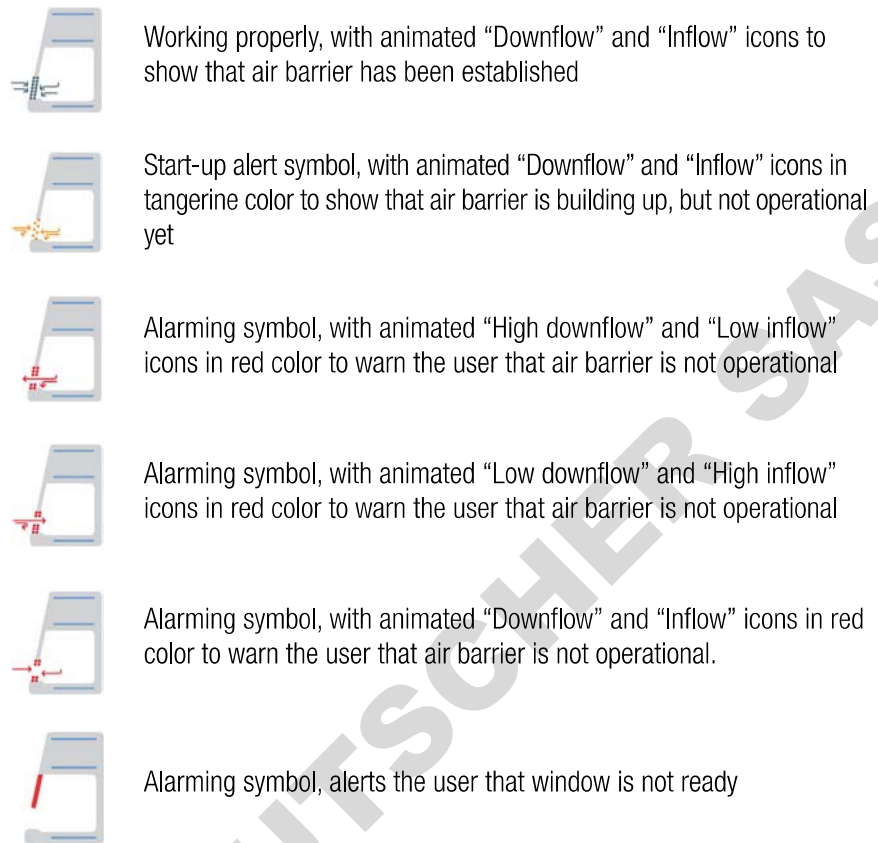

Figure 28 Overview of Side-View Symbol Graphics for Unit Status

Three status indicator boxes appear in the center of the Main Screen. They show, from top to bottom, the state of the window, plus the downflow and inflow statuses.

Status indicator boxes may display with four different status icons:



The checkmark on the green circle indicates that this particular function is working properly.



The yellow animated “Timer” icon indicates that the unit is working up towards an operational state.



The white cross on the red circle indicates that there is a problem with that particular function.



The light gray dash on the gray circle signifies there is no activity. This icon indicates, for example, that there is no airflow when the unit is on, but the fans are off.

The following examples show different combinations of status indicator boxes for major operational states.

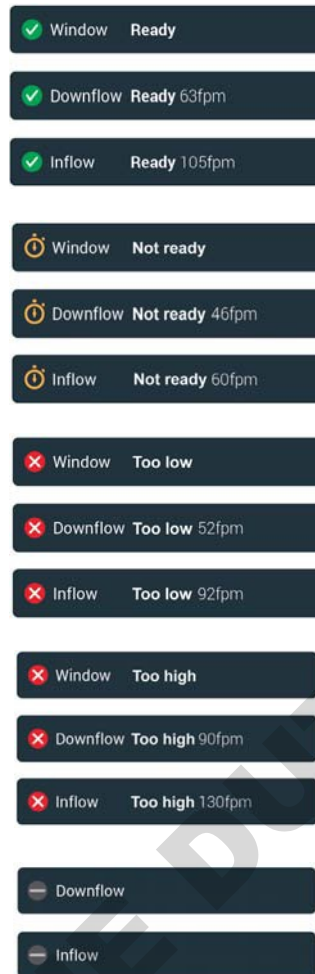

All green circles with checkmark: unit is ready.

All yellow timers: unit is not ready, but running up to operational state.

All red circles with cross: window and airflow values are too low.

All red circles with cross: window and airflow values are too high.

All gray circles with dash: no activity because the fans are off.

Examples for windows with different operational states are shown below.

Control Panel (Region R2B)

The Control Panel in Screen Region R2B contains a complete set of controls for operating the functions of the biological safety cabinet. The inventory of buttons varies with the number of options built into the unit, as can be seen in Figure 29 and Figure 30.

The Control Panel is visible at all times below the Main Screen.

Figure 29 shows the control panel for a biological safety cabinet equipped with all options, including a motorized window, sample chamber illumination, sample chamber fans, gas supply and a power receptacle in the sample chamber.



Figure 29 Control Panel for fully equipped Unit

Functions that are currently working are identified by a light gray frame around the button, as shown in the bottom rows of Figure 29 and Figure 30. A frame dimmed to dark gray, as shown in the top rows, indicates that the function is available, but currently not in use.

Figure 30 shows the Control Panel for a unit equipped with all options but the gas supply.

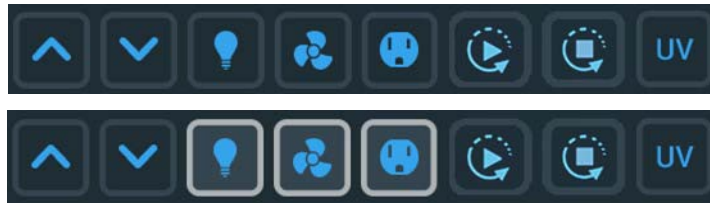

Figure 30 Control Panel for Unit without Gas Option

The functions of the individual control panel buttons are explained in Figure 31 below.



The “Open window” and “Close window” buttons (available on units with a motorized window) labeled with up and down arrows raise and lower the window.



The “Light Bulb” button switches the interior sample chamber illumination of the biological safety cabinet on and off.



The “Fan” button switches the interior sample chamber fans of the biological safety cabinet on and off. Tap and hold this button for 5 sec. to switch the fans on or off. During the UV disinfection cycle, the fans run in reduced flow mode, which is indicated by a small blue circle labeled “1/2” (see lower image on the left side). The fans also run in reduced flow mode when the front window is closed and there is no UV disinfection ongoing.

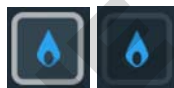

On units equipped with the gas option, the “Gas” button opens or closes the valve that controls the gas supply to the sample chamber. If the window is open to working position, and the fans are running and airflow speed is ok, you may tap the “Gas” button to open the gas valve.

In any other condition, the “Gas” button will not open the gas valve and a pop-up message appears stating:

The gas valve can only be opened when the window is in the working position, the fans are running, and there are no active alarms.

The “Gas” button is deactivated automatically if the user shuts the window, turns the fans off, or if an alarm is triggered.



The “Power Receptacle” button switches the power receptacles in the sample chamber of the biological safety cabinet on and off.



The “Autostart” button starts the unit immediately with the set of functions previously selected in the “Autostart” settings (see “Programs” on page 86). Tap and hold this button for 3 sec. to start the unit in “Autostart” mode.





The “Autostop” button stops the unit immediately, closing the window and leaving only a user-selected set of functions enabled, as previously selected in the “Autostop” settings (see “Programs” on page 86). Tap and hold this button for 3 sec. to stop the unit in “Autostop” mode.

If you have selected the closing of the front window in the Autostop settings (see “Setting up AutoStop” on page 89), you need to keep the AutoStop button  pressed until the movement of the front window stops completely.



The “UV” button switches UV disinfection of the sample chamber on and off.

Figure 31 Buttons on the Control Panel

When operating the “Close window”  and “AutoStop” buttons , you must tap and hold the button until the window is closed. This is a safety feature.

To aid users in this gesture, the tooltip-style bubble shown in Figure 32 is displayed on screen when you press either button.

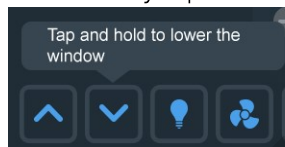



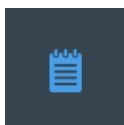





Figure 32 Tooltip Bubble over “Close window” Button

Main Navigation Bar (Region R3)

The Main Navigation Bar (in Screen Region R3) holds icons for all major settings of the Herasafe 2030i and Maxisafe 2030i biological safety cabinets.

The Main Navigation Bar is visible at all times on all screens.

Icon	Meaning
	“Back” button: cycles through all screens previously displayed (grayed out if on Main Screen).
	“Home” icon: returns to the Main Screen.
	“Settings” icon: opens the “Settings” screen (see “Settings” on page 73) with various options for parameter settings.
	“Event Log” icon: (see “Event Log” on page 114)

Icon	Meaning
	“Alarms and Alerts” icon ¹ : opens the “Alarms and Alerts” screen (see “Alarms and Alerts” on page 91).
	“Data Plate” icon ¹ : opens the “Data Plate” screen (see “Data Plate” on page 97) showing general data about the unit.
	“Programs” icon ¹ : opens the “Programs” screen (see “Programs” on page 86), where you can program the AutoStart and AutoStop functions.

¹ can also be accessed from the “Settings” screen

Figure 33 Main Navigation Bar

Working Mode

Figure 34 shows the Main Screen in working mode.



Figure 34 Main Screen - Unit working

The side-view symbol graphic shows that the window is opened to working position, and the arrows in the animated “Air barrier” icon show that the air barrier is working properly. The three status indicator boxes to the right of the symbol graphic show green checkmarks to indicate that the window is at the correct position, and that downflow and inflow speed are at their correct values.

Buttons are highlighted in the Control Panel Area to indicate that the sample chamber illumination, fans, gas supply, and power receptacle functions are all on, as needed for a working session. The “AutoStop” button  is available because the unit is running.

Startup Mode

Figure 35 shows the Main Screen while the unit is starting up. The following startup screen shows what happens when the “AutoStart”  or “Fan” button is tapped: The screen shows alerts for the air barrier because the airflow speeds are not up to speed yet.



Figure 35 Main Screen - Unit starting up

The symbol graph shows that the window is opened to the working position, and the animated yellow arrow and air barrier symbols indicate that the airflow is not ready. The three status indicator boxes show:

- a green checkmark icon in the window status box to indicate that the window is ready, but
- yellow “Timer” icons with rotating hands show in the Downflow and Inflow boxes, signifying that the airflows are not up to proper speed yet.

NOTE When the operational downflow and inflow speeds are reached, the yellow timers are replaced by green checkmark icons.

Figure 35 shows a typical startup mode example for “AutoStart”, with the “Lights”, “Fans”, and “Power receptacle” buttons already enabled (see “Programs” on page 86 for more details). If enabled in AutoStart, the “Gas” button  may come on later when the airflows are up to speed.

Standby Mode

Figure 36 shows the Main Screen in standby mode.



Figure 36 Main Screen - Unit in Standby

Standby mode is entered when you close the window from within a working session, which is indicated by the closed window in the side-view symbol graphic. A Standby header appears to the right of the graphic, showing the unit is in standby mode, maintaining cleanliness and containment, and ready to resume work when you move the window back to the working position. The green checkmark next to the Standby header signifies that everything is working properly.

In the Control Panel Area, buttons are highlighted to indicate that functions are still on, including the sample chamber illumination, the fans, and the power receptacles. The “AutoStop” button  is also available because the unit is running.

If the window is closed, the fans will switch to reduced flow, as indicated by the small blue circle with the “1/2” label .

Cleaning and Loading Mode

Cleaning mode is entered when you fully open the front window using the hinge for accessing the sample chamber, for example, in order to decontaminate or introduce larger accessories. Cleaning mode is indicated by the flipped-up window in the side-view symbol graphic and the “Cleaning mode” header that appears next to it, as shown in Figure 37.

Additional text like “SmartClean Plus” and “Sample chamber open for cleaning and/or loading or unloading.” further explains what cleaning mode is for.

The “Health Status” icon in the Info & Health Status Area is a yellow alert triangle.



Figure 37 Main Screen - Unit cleaning

Idle Mode

Idle mode is entered when you turn all functions (including the fans) off, with the window either in the working position or closed. Idle mode is indicated by the gray “no activity” icons in the downflow and inflow status indicator boxes, as shown in Figure 38.



Figure 38 Main Screen - Unit in Idle Mode, Window closed

Idle mode is also possible with the window opened to the working position, as shown in Figure 39. In this case, the downflow and inflow status indicator boxes show an “Alert” icon.



Figure 39 Main Screen - Unit in Idle Mode, Window open

Sleep Mode

After an inactivity period of 15 minutes, the device goes to Sleep Mode and displays a screensaver. The screensaver is a blank screen with a moving “Tap to wake” prompt, as shown in Figure 40.

Sleep Mode is activated after 15 minutes when the following prerequisites are met:

- the user does not interact with the device
- no pending or new alarms exist
- the window is closed
- the fans are switched off

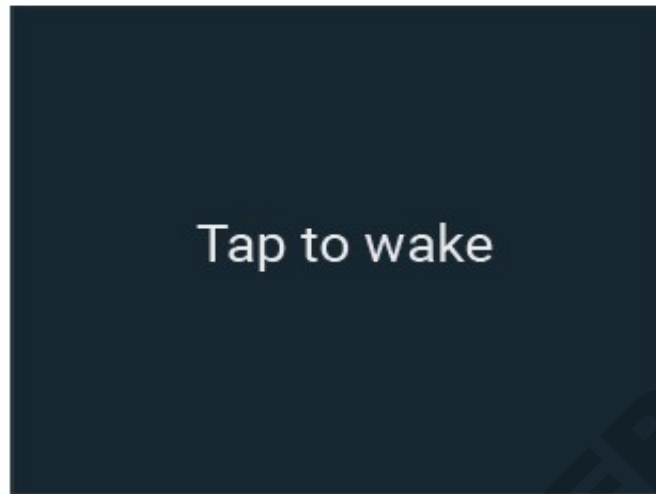

Figure 40 „Tap to wake“ Screensaver

To exit Sleep Mode and return to the previous screen, tap anywhere on the touchscreen display.

The device exits Sleep Mode automatically when one of the following occurs:

- a new alarm occurs
- the window is opened by pressing the rocker switch (see “Using the auxiliary Rocker Switch” below)
- the fans are switched on

Sleep Mode can be activated or deactivated in the display settings (see “Display Settings” on page 77).

Handling and Control

The following section describes basic, everyday operations you need for working with the device:

Using the auxiliary Rocker Switch

The basic window functions required for the operation of the device can be controlled using the auxiliary rocker switch:

- During a power failure the front window can be lowered, raising is possible only, if mains supply is re-established.

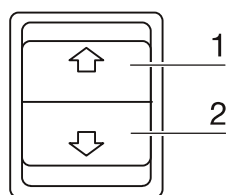

Figure 41 Basic window functions of the auxiliary Rocker Switch

Moving the Front Window

The movement of the front window is controlled by depressing the auxiliary rocker switch control element with the corresponding arrow symbol.



Crushing hazard

During movement of the front window do not try to access the inner chamber.

Proceed as follows to raise the window:

1. Press the control element [1/Figure 41].

When the front window reaches the working position, the movement stops automatically. If the movement starts above the working position, the front window stops at the maximal opening position.

2. To stop the upward movement, release the control element.
3. To lower the window, keep the control element depressed [2/Figure 41].
4. To stop the downward movement, release the control element.

When the front window reaches its working position, the movement stops automatically, the audible alarm signal is switched off, and the green “Health Status Good” icon  appears in the Info & Health Status Area at the top of the “Display Settings” screen.

When the front window does not reach the working position, the “Health Status Alarm” icon  appears in the Info & Health Status Area at the top of the display screen, along with a scrolling alarm description. For details on how to handle alarms, please refer to the section “Silencing and Handling Alarms” on page 67.

The audible alarm signal is switched off when the front window is completely closed.

Moving the Front Window to the Working Position



Crushing hazard

During movement of the front window do not try to access the inner chamber.

Proceed as follows to move the front window up to the working position:

1. Tap the “Open window” button  on the Control panel to raise the window from the closed to the working position.

When the front window reaches the working position, the movement stops automatically. When the movement starts above the working position, the front window stops at the maximal opening position.

NOTE The working position is factory pre-set and cannot be changed in the Settings.

Proceed as follows to stop the upward movement:

2. Tap the “Close window” button .

Proceed as follows to continue the upward movement beyond the working position:

3. Tap the “Open window” button .

Lowering the Front Window

Proceed as follows to lower the front window:

1. Tap the “Close window” button  on the Control panel and keep it depressed until the window reaches its closed position.

Proceed as follows to stop the downward movement:

2. Release the “Close window” button .

Switching the Sample Chamber Illumination on and off

In each operating mode but the UV disinfection cycle, the sample chamber illumination can be switched on or off.

Proceed as follows to switch the illumination on or off:

1. Tap the “Light Bulb” button  to switch on or off.

The illumination comes on, and the “Light Bulb” button  is displayed with a light gray border.

Activating and Deactivating the internal Power Supply Receptacles

All power outlets in the sample chamber can be activated (power supply on) or deactivated (power supply off) simultaneously.

Proceed as follows to activate the power receptacles:

1. Tap the “Power Receptacle” button .

The powered accessories in the sample chamber are turned on, and the “Power Receptacle” button  is displayed with a light gray border.

Proceed as follows to deactivate the power supply receptacles:

2. Tap the “Power Receptacle” button .

The powered accessories in the sample chamber are turned off, and the light gray border on the “Power Receptacle” button  disappears.

Activating and deactivating the internal Gas Supply

The solenoid valve controlling the gas inflow can be opened and closed from the Control Panel.

NOTE The solenoid valve for activating the internal gas supply is an additional safety feature that enables the gas supply to the safety cabinet. The main gas supply is controlled by a media valve or other external shut-off device.

Proceed as follows to activate the gas inflow:

1. Tap the “Gas” button .

Gas starts streaming through media valves within the sample chamber, and the “Gas” button  is displayed with a light gray border.

Proceed as follows to deactivate the gas supply:

2. Tap the “Gas” button .

The solenoid valve gives a clicking sound, the gas supply to the sample chamber is turned off, and the light gray border on the “Gas” button  disappears.

Logging into a Passcode-protected Unit

In laboratory environments with exacting biosafety requirements, there may be a need to restrict access to the biological safety cabinet.

This enhanced level of biosafety is afforded by Secure Mode.

NOTE Secure Mode can only be enabled by an administrator. The process of enabling Secure Mode is described in the section “Access Control” on page 112.

If the unit is in “Secure” Mode, the word “Login” appears in the top right corner of the Info & Health Status Area, as shown in Figure 42 below.



Figure 42 Info & Health Status Area with “Login” Prompt

As a regular user, your login is not time-limited, that is, the session will never time out.

When you tap “Login”, a login box appears in the center of the screen, then slides up while a keyboard slides in from the bottom.

NOTE If the unit is set to “Open” mode, the word “Login” will not be displayed in the top right corner of the screen. Some specialized functions require that you log in, though. For example, when you tap the “Factory Settings” or “Field Certification” buttons in the “Settings” screen (see “Settings” on page 73) you will be prompted to log in.

Logging in

Proceed as follows to log into a unit in “Secure” Mode:

1. Tap the word “Login” in the top right corner of the screen, or tap anywhere else on the screen.

The “Login” screen appears on top of the screen, then a keypad slides up from the bottom and pushes the “Login” screen up towards the top of the screen (see Figure 43).

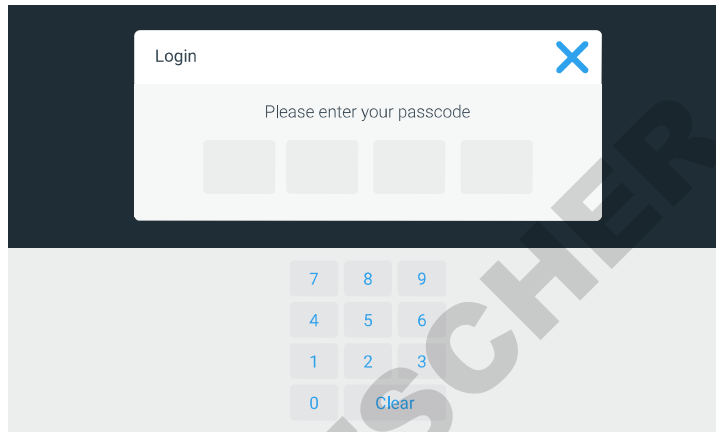

Figure 43 “Login” Screen

2. Enter your four-digit passcode, or tap the “X” icon to exit and close the window if you do not want to log in.

After entering the last digit, you will be logged in. The Main Screen appears, with the word “Logout” (instead of “Login”) in the top right corner.

NOTE If you have entered an incorrect passcode, an error message appears below the passcode field. Try again using the correct passcode.

Logging out

1. Tap the word “Logout” in the top right corner of the screen.

The “Log out” screen shown in Figure 44 appears on top of the screen, asking you to confirm that you want to log out.

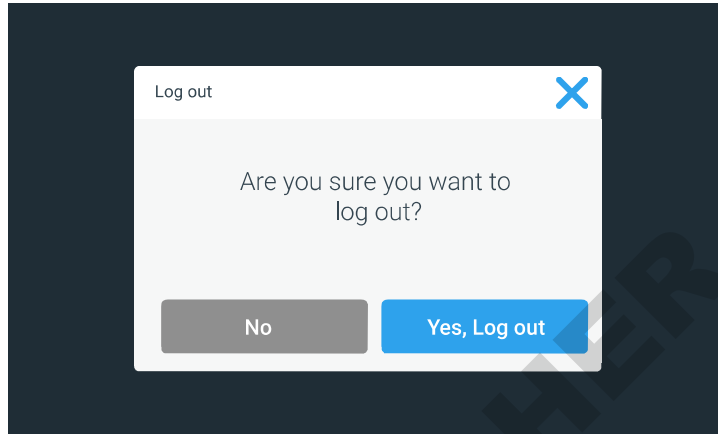

Figure 44 “Log out” Screen

2. Tap the “Yes, Log out” button to confirm, or tap the “No” button or “X” icon in the top right corner to exit and close the window if you do not want to log out.

The confirmation message appears shown in Figure 45, confirming that you have been logged out successfully.

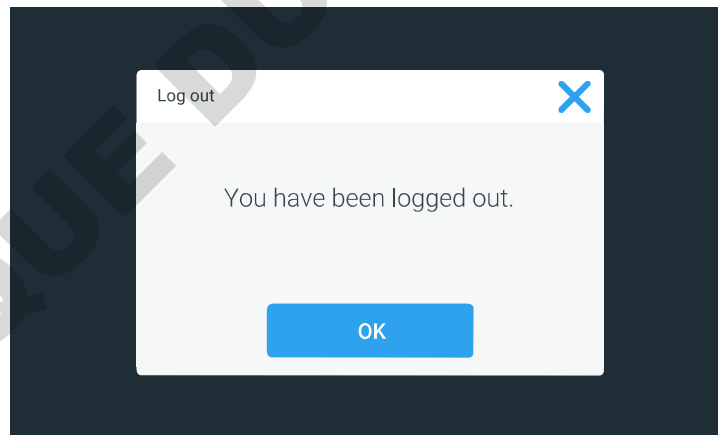

Figure 45 “Log out” Screen: Logged out Message

You will be returned to the main home screen, regardless of the screen you were viewing before you decided to log out. In “Secure” mode, the unit also automatically shuts off all functions that were previously on, such as illumination, fans, power receptacles, gas. You may still raise or lower the window on the unit.

Running UV Disinfection

The biological safety cabinet has a built-in UV disinfection routine that affords an intensifying additional disinfection after a standard wipe/spray disinfection. UV disinfection can be started by pressing the “UV” button on the Control Panel.

For running the UV disinfection routine, the front window must be completely lowered to protect against UV radiation. A safety interlock ensures that the routine cannot be run until the front window is in the closed position.

While the routine is running, the “UV disinfection” screen shown in Figure 46 below is displayed on the Main Screen.



Figure 46 Main Screen: “UV disinfection” running

The “UV disinfection” screen sports the side-view symbol graphic with the window closed and a purple orb in the sample chamber. To the right of the graphic a green checkmark and the “UV disinfection” header identifies the current mode of operation.

Additionally, the “Total cycle time” in hours and the time remaining in hours, minutes and seconds are displayed.

UV disinfection ends when the preset total cycle time for the routine has elapsed. Then, the UV lamps are switched off automatically, and the “UV disinfection” screen goes away.

If the setting for “UV disinfection” (see “Setting UV Disinfection Cycle Time” on page 74 for instructions) includes an adjustment for bulb life, the label for the total cycle time display reads “Total adjusted cycle time”, as shown in the example in Figure 47.



Figure 47 Main Screen: Disinfection running with Adjustment for Bulbs

Tapping the “Total cycle time: n hr” label will take you to the “Disinfection Cycle Settings” screen if you need to change the setting. The process of setting cycle time is described in the section “Setting UV Disinfection Cycle Time” on page 74.

You can also tap the “Power Receptacle” button  on or off during an ongoing UV disinfection cycle.

When the “Light Bulb” button  is tapped, a pop-up window appears, stating “The LED light cannot be switched during the UV disinfection cycle. Would you like to abort the UV cycle and switch the LED lights on?”

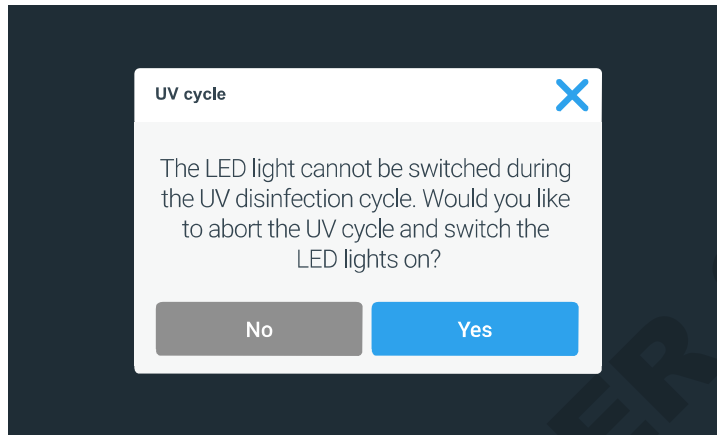



Figure 48 UV Cycle Alert when “Light Bulb” Button is tapped during UV Disinfection

You may then choose to continue by tapping “No”, or abort UV disinfection by tapping “Yes”.

Starting the UV Disinfection Cycle

Proceed as follows to start the UV disinfection cycle:

1. Tap the “Close window” button  on the Control panel to close the window. Hold the button all the way until the window is closed.

The tooltip-style bubble shown in Figure 49 appears above the button as a reminder that you need to close window completely.

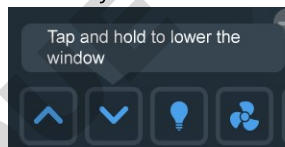



Figure 49 Tooltip Bubble over “Close window” Button

2. If the “UV” button  is pressed while the front window is open and/or the sample chamber illumination is on, the following pop-up window will appear.

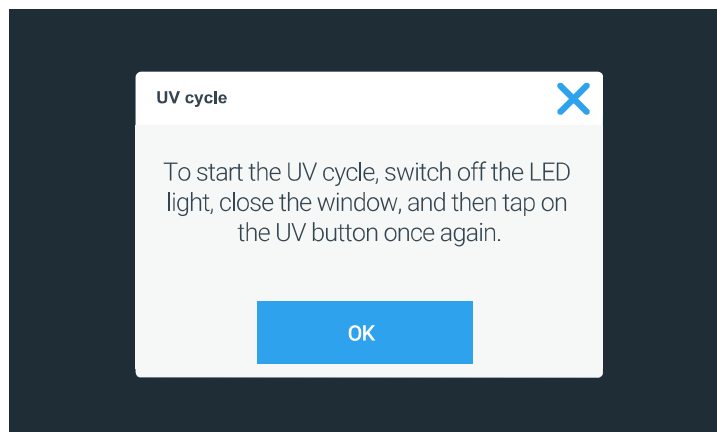







Figure 50 UV Cycle Alert when Window is open / Illumination is on

3. If this happens, tap the “OK” button to close the pop-up window, then use the “Light Bulb” button  to turn off the sample chamber illumination and/or the “Close window” button  to close the window.
4. Tap the “UV” button  on the Control panel (again) to start the UV disinfection cycle.

The “UV Disinfection” screen shown in Figure 46 appears. The sample chamber illumination is off, the fans are on at reduced speed, the gas supply is off, and the power receptacle is off. The “AutoStop” button  is available as the unit is running. The “UV”  and “Fan”  buttons are highlighted with a light gray frame to indicate that both functions are on. The “Fan” button is displayed with a “1/2” label in a small blue circle to indicate that the fans are running in standby mode.

NOTE If you need to extend or shorten the UV disinfection cycle, you can tap the “Total cycle time: n hr” label to go the “Disinfection Cycle Settings” screen. The process of setting cycle time is described in the section “Setting UV Disinfection Cycle Time” on page 74.

5. Wait until the UV disinfection cycle is complete.

Completion of the UV disinfection cycle is announced by the alert message shown in Figure 51.

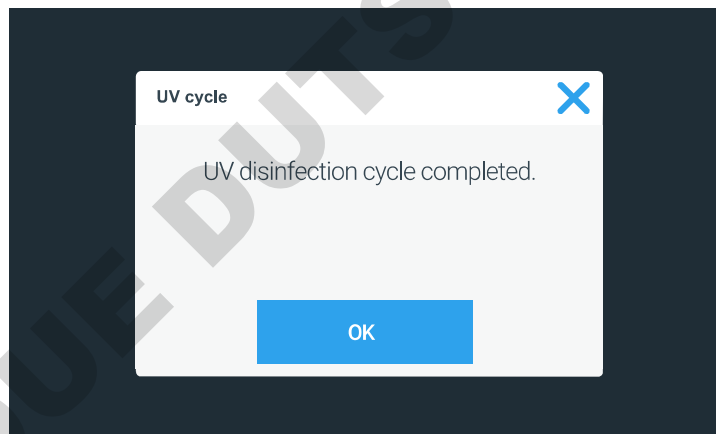

Figure 51 UV Disinfection Cycle complete Alert

6. Tap the “OK” button to complete the UV disinfection cycle.

Turning the Fan on and off during UV Disinfection

In UV Disinfection mode, the only other button that can be pressed is the “Fan” button. When the “Fan” button is pressed on, the fans are turned on in Stand-by mode and will remain on until you turn them off.

Proceed as follows to turn the fan on during a UV disinfection cycle:

1. From within the running UV disinfection cycle, press the “Fan” button  for 5 seconds.

If this is the first time you turn the fans on during the ongoing UV disinfection cycle, the pop-up window shown in Figure 52 will appear, reminding you that the fans will continue to run in reduced flow mode after the UV disinfection cycle is complete.

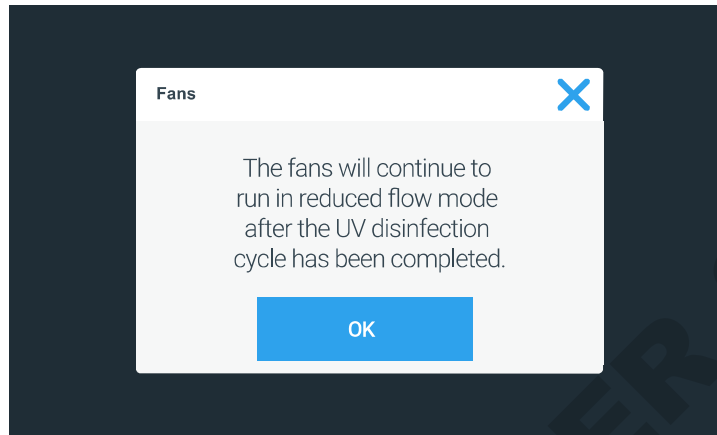

Figure 52 Reduced Flow Mode Alert during UV Disinfection Cycle

The “Fan” button will change its appearance, displaying a gray border and a small blue circle labeled “1/2” to indicate that the fans are running in reduced flow mode (see Figure 53).

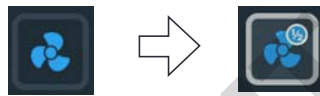



Figure 53 “Fan” Button in Off Mode vs UV Disinfection Mode

2. Tap the “OK” button or the “X” icon in the top right corner to close the window, or wait for the window to close automatically after 10 seconds.

Proceed as follows to stop the fans while a UV disinfection cycle is running:

1. Tap the “Fan” button  on the Control panel to stop the fans.

The “Fan” button will change its appearance, returning to its “off-state” image (see Figure 54).

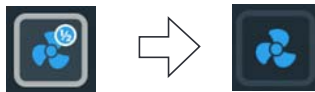

Figure 54 “Fan” Button in UV Disinfection Mode vs Off State

2. Tap the “OK” button or the “X” icon in the top right corner to close the window, or wait for the window to close automatically after 10 seconds.

Restarting a disrupted UV Disinfection Cycle

If the UV disinfection cycle is disrupted, for example, because the front window has been opened or another error has occurred, a pop-up window appears, stating that the UV disinfection cycle has been disrupted (see Figure 55 below).

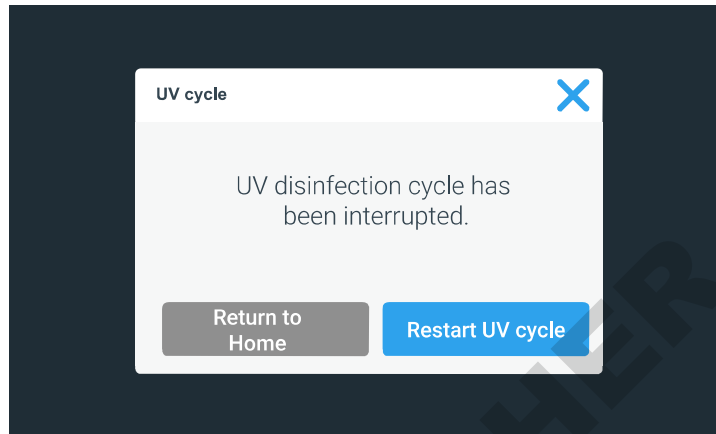

Figure 55 UV Disinfection Cycle was disrupted Alert

Proceed as follows to restart a disrupted UV disinfection cycle:

1. Correct the problem, for example by closing the window.
2. Tap the “Restart UV cycle” button, or tap the “Home” icon to exit.

The UV disinfection cycle will start over.

Alarms

If the downflow, inflow or window parameters are not at operational settings, there may be at risk of exposure to biohazardous material or contamination. In this case, the biological safety cabinet emits a visual and audible alarm to alert the user, as shown in Figure 56 below.

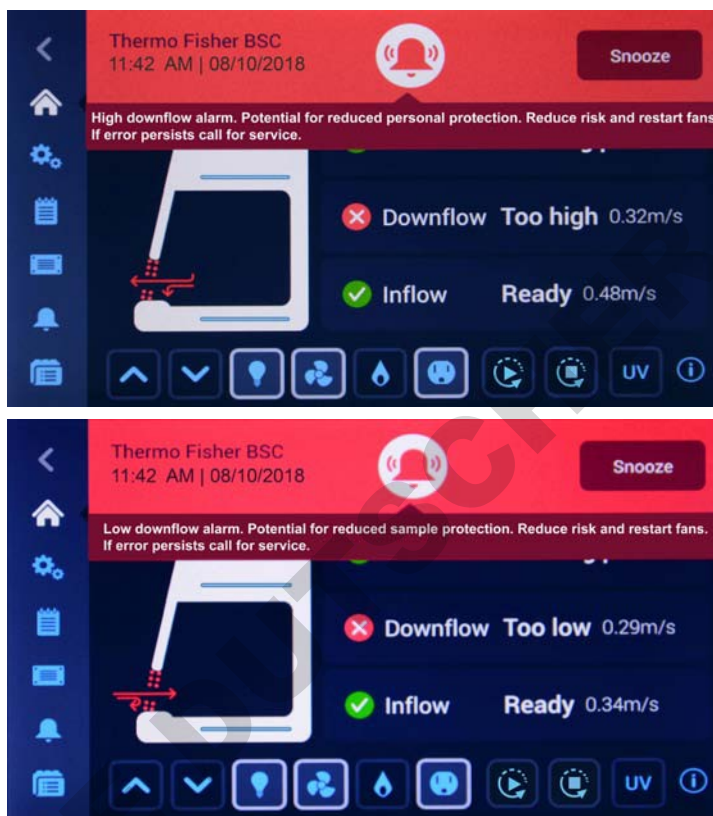

Figure 56 Alarming Screen for Downflow too high and too low Alarm

A “Health status” icon in the shape of an alarm bell appears on a red background, along with a “Snooze” button. Directly below the “Bell” icon, descriptive text explains the issue and provides instructions on how to troubleshoot it. If there is more text than will fit on screen, the text scrolls from right to left in “newsticker fashion”. When multiple alarms occur at the same time, the “Health status” icon has a small blue circle overlay that shows the number of pending alarms, and additional alarm descriptions appear in the newsticker section.

The symbol graphic in the Main Screen appears with a pertinent animation that identifies the type of problem and its location. For example, the air barrier sliced in two by red arrows shown in Figure 56 indicates that there is a downflow problem (see Figure 28 on page 46 for a complete overview of appearances).

Tapping the “Snooze” button silences the audible alarm temporarily for a pre-set timeout period. (The default alarm snooze timeout period is 5 minutes, but the setting may be changed in the “Alarms and Alerts” screen, as explained in “Snooze Timeout” on page 93). The “Alarm bell” icon is crossed out to indicate that the audible alarm signal has been snoozed (see Figure 57 on page 66).

NOTE
Applicable BSC standards in effect may not allow temporary muting of audible alarm and limit the available choice of alarm tones.

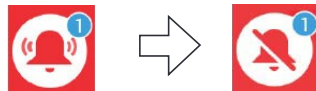

Figure 57 “Health Status Alarm” Icon (“Alarm Bell”) in unsnoozed and snoozed Modes

If you tap the red “Health Status Alarm” icon instead of the “Snooze” button, the audible alarm is automatically snoozed, but the countdown timer shown in Figure 58 appears immediately next to the “Snoozed alarm” icon to indicate when the audible alarm will return.

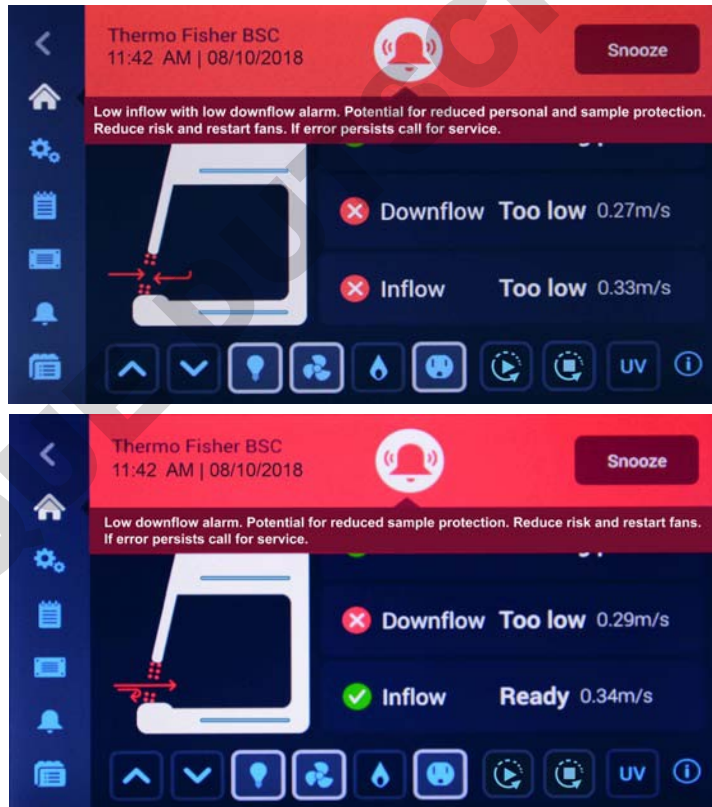

Figure 58 Alarming Screen with snoozed Alarm

Additionally, you will be taken directly to the Health Status Danger screen with its alarm list shown in Figure 59.

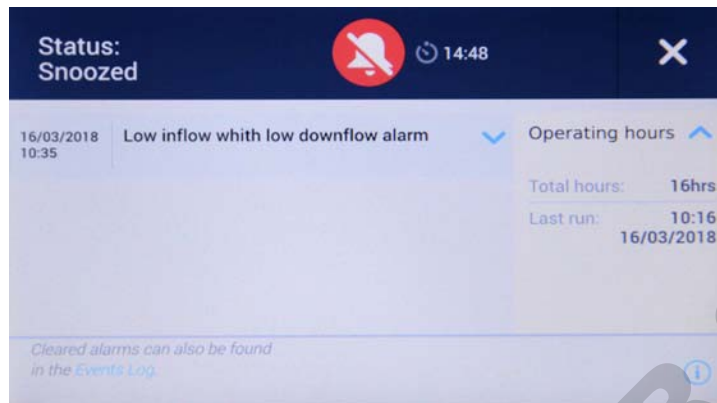

Figure 59 “Health Status Alarm” Screen

Once the ticker message has been visible for two cycles of displayed text, the screen changes to the appearance shown in Figure 60 below:





Figure 60 Main Screen after two Cycles of Alarm Ticker Message

The “Health status” icon has changed to show the audible alarm is snoozed. To the right of the “Health status” icon is a countdown timer showing the snooze time remaining, that is, the time period after which the audible alarm is resumed.

When the issue causing the alarm has been resolved, for example, when the user moves the front window to the appropriate position, the audible and visual alarms automatically disappear, and the screen display returns to the healthy state (see “Viewing General Status Information” on page 70).

Silencing and Handling Alarms

Proceed as follows to silence the audible alarm and handle the problem:



1. When an audible alarm is sounded, go to the biological safety cabinet and tap the “Snooze” button  to temporarily silence it.
2. Inspect the small blue alarm counter in the red “Health Status Alarm” icon  to find out whether you have to handle one or more alarms.

3. Read the instructions in the newsticker area to learn more about the issue(s) and available troubleshooting options.

After two cycles of displayed text, the ticker message disappears and is replaced by the Main Screen shown in Figure 60 above.

4. Tap the red “Health Status Alarm” icon  to display the “Health Status Alarm” screen shown in Figure 59 and review the alarm list.
5. Correct each issue that has caused an alarm.

As you correct the pending issues, they will disappear from the alarm list on the “Health Status Alarm” screen one by one.

When the last issue has been cleared, the screen display returns to the healthy state and the green “Health Status Good” icon  replaces the red “Health Status Alarm” icon .



The alarm volume should be adjusted in the “Alarms and Alerts” screen according to the sound level of the environment lab.

Alerts

Some events in the biological safety cabinet that do not immediately affect containment or cleanliness produce alerts. These alerts appear with the visual features shown in the example in Figure 61.

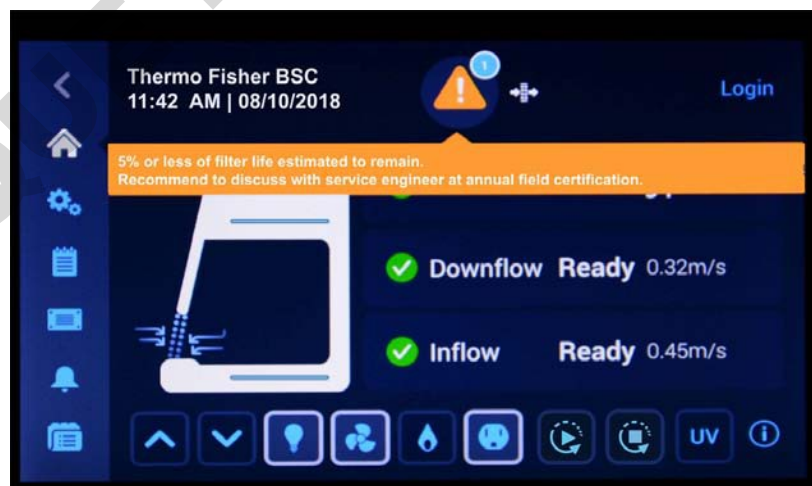

Figure 61 “Alert” Screen with Filter Replacement Reminder

The “Health Status Alert” icon in the shape of a yellow “Alert triangle” icon appears on a black background and a short signal sounds. Directly below the “Alert triangle” icon, descriptive text explains the issue and provides instructions on how to correct it. If there is more text than will fit on screen, the text scrolls from right to left in “newsticker fashion”. When multiple alerts occur at the same time, the “Health status” icon has a small blue circle overlay that shows the number of pending alerts, and additional alert descriptions appear in the newsticker section.

The symbol graphic in the Main Screen appears remains unchanged. In the filter message example shown in Figure 61, the air barrier is displayed as fully functional (see Figure 28 on page 46 for a complete overview of appearances).

If you tap the “Alert triangle” icon, you will be taken directly to the “Status Alert” screen with its alert list, shown in Figure 62.

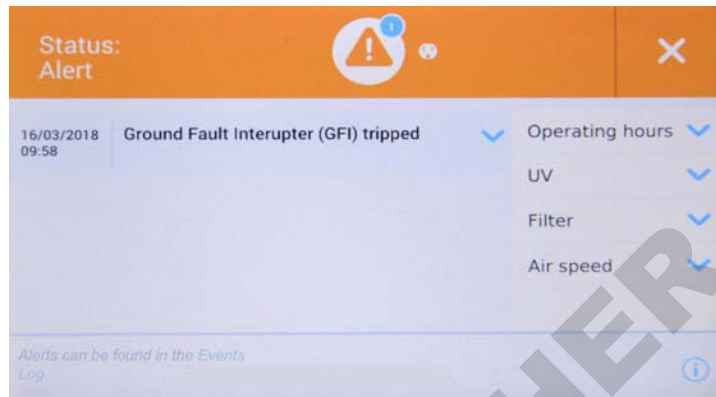

Figure 62 “Status Alert” Screen with Alert Screen Message, Status Alert GFI

Events that produce alerts include:

- GFI (Ground Fault Interruptor; US versions only) has tripped and switched off the power receptacle
- Filter nearing end of life and needing replacement
- UV light bulb nearing end of life and needing replacement
- Field Certification expiring

Each type of alert has a specific icon that appears both to the right of the “Alert” icon and in the “Status Alert” screen.

Once the ticker message has been visible for two cycles of displayed text, the ticker will go away and the screen changes to the appearance shown in Figure 63 below:

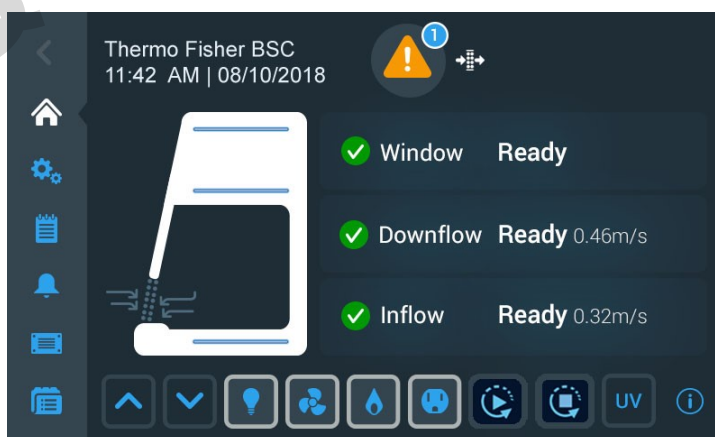

Figure 63 Main Screen after two Cycles of Alert Ticker Message

When the issue causing the alert has been resolved, for example, when the user has replaced the filter, the alert can be cleared from the status screen, and the screen display returns to the healthy state (see “Viewing General Status Information” on page 70).

Handling Alerts

Proceed as follows to handle alerts:

1. When an alert appears, inspect the small blue alarm counter in the “Health Status Alert” icon 🚨 to find out whether you have to handle one or more alerts.
2. Read the instructions in the newsticker area to learn more about the alert(s) and available troubleshooting options.

After two cycles of displayed text, the ticker message disappears and is replaced by the Main Screen shown in Figure 63 above.

3. Tap the yellow “Health Status Alert” icon to display the “Status Alert” screen shown in Figure 62 and review the alerts list.
4. Tap any entry in the alarm list to view additional details, as in the GFI Tripped (US versions only) example in Figure 64 below.

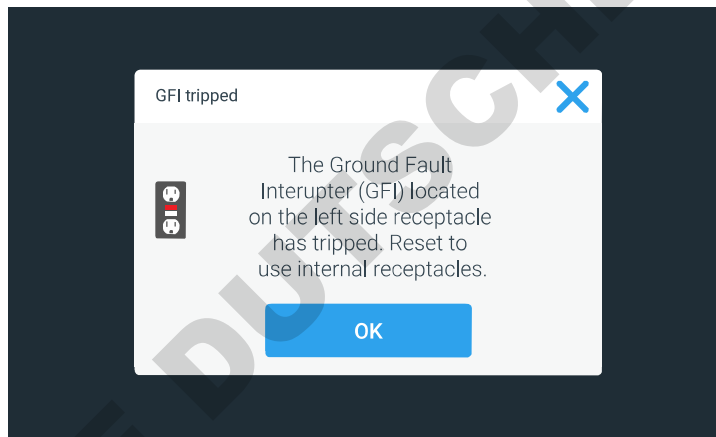

Figure 64 “GFI tripped” Alert Details Screen

5. Correct each issue that has caused an alarm.

As you correct the pending issues, they will disappear from the alerts list on the “Health Status Alert” screen one by one.

When the last issue has been cleared, the screen display returns to the healthy state and the green “Health Status Good” icon 🟢 replaces the yellow “Health Status Alert” icon 🚨.

Viewing General Status Information

There are two dedicated screens for viewing general status information on a unit that is free of alarms and alerts. The first of the “Status Good” screens opens when you tap the “Health Status Good” icon in the Info & Health Status Area of the screen. See the description of the “Info & Health Status Area” on page 44 for details.

Additionally, you may reset the UV light bulb operating hours in this screen.

NOTE Although a “Reset” button appears on-screen, resetting of the HEPA filter operating hours can only be done by an authorized field service technician.

The “Status Good” screens display the following information:

- First screen:
 - Total Operating Hours including last time the cabinet was run
 - UV light total operating hours, last cycle, and install date
- Second screen:
 - Filter running time, estimated time left, and install date
 - In-Cabinet power receptacles: GFI Status (Ready or Tripped; North American market version only)
 - Air speed: Inflow and Downflow

The two screens can be navigated by swiping left or right or tapping the small left/right chevron icons. Two dots signify the number of screens available in this section and indicate which screen you are currently viewing; the dot for the active screen is always solid, while the hidden screen appears in outline shape.

Viewing UV Light Bulb and HEPA Filter Lifetime

Proceed as follows to display the remaining useful service life of the UV light bulb and HEPA filter:

1. Tap the “Status Good” icon  in the Info & Health Status Area on top of the Main Screen.

The “Status Good” screen shown in Figure 65 appears, displaying the first suite of status data.



Figure 65 “Status Good” Screen #1: Operating Hours, UV and Filter

2. If you have just changed the UV light bulb, tap the “Reset” button below the UV display area.

The “UV Total hours” counter and “Last cycle” date will be reset to zero and a default date, while the “Installed” date will be reset to the current date.



Reset the UV operating hours only when you have positively replaced the UV light bulb. Resetting the operating hours without previously replacing the UV light bulb results in a misleading operating hours count. When the lifetime of the UV bulb expires, UV disinfection efficiency may be compromised, but no pertinent alarm message will be given. This may result in latent biohazards that may go unnoticed.

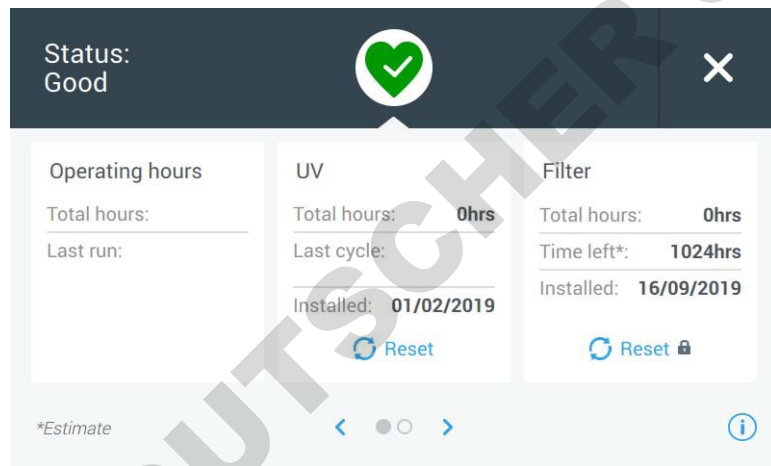

Figure 66 “Status Good” Screen #2: Operating Hours, UV and Filter (EU Version)

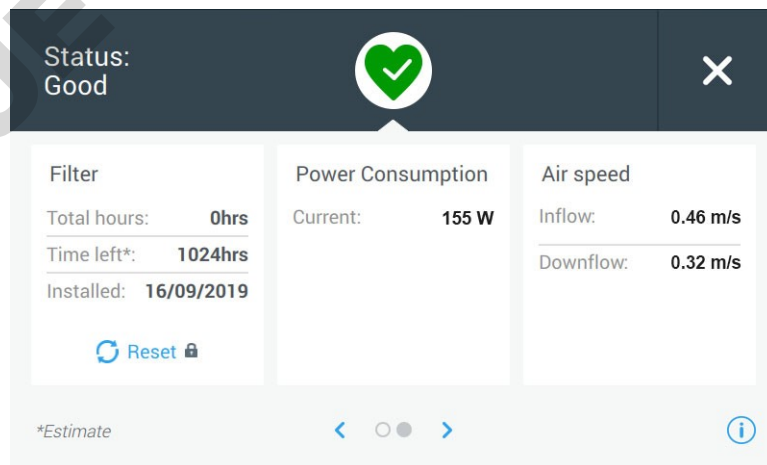

Figure 67 “Status Good” Screen #2: Filter, Power Consumption and Air Speed

3. Swipe the screen to the left or tap the right blue chevron in the navigation area at the bottom center to display the second suite of status data, shown for the EU version in Figure 66 and for the US version of the device in Figure 67 below.
4. When you are done viewing status data, tap the “X” icon in the upper right corner to close the “Status Good” screen.

You will be returned to the Main Screen.

Settings

This section explains how to set up the unit using the various options of the “Settings” screen.

After completing the initial setup process, you can further set up and customize the unit by using the options of the “Settings” screen shown below in Figure 68.

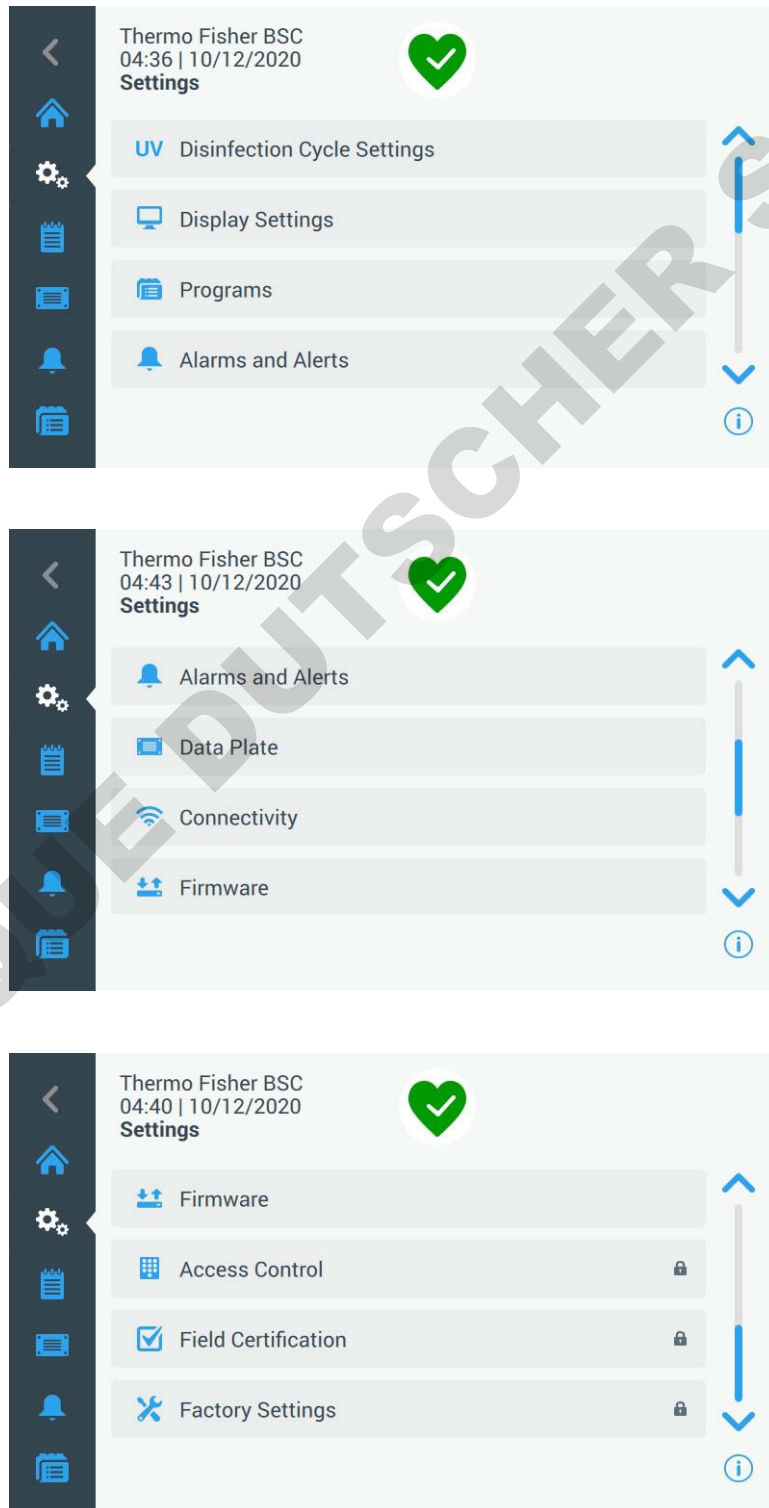



Figure 68 “Settings” Screen

The “Settings” screen opens up when you tap the “Settings” icon  in the Main Navigation Bar. It offers nine menu items that can be tapped to open further screens with advanced adjustment options:

- “Disinfection Cycle Settings”: See “Setting UV Disinfection Cycle Time” on page 74.
- “Display Settings”: See “Display Settings” on page 77.
- “Programs”: See “Programs” on page 86.
- “Alarms and Alerts”: See “Alarms and Alerts” on page 91.
- “Data Plate”: See “Data Plate” on page 97.
- “Connectivity”: See “Connectivity” on page 98
- “Firmware”: See “Firmware Update” on page 112
- “Access Control” (password protected): See “Access Control” on page 112.
- “Field Certification” (password protected): See “Field Certification” on page 113.
- “Factory Settings” (password protected): See “Factory Settings” on page 113.

NOTE Some of these items are also available as shortcuts on the Main Navigation Bar.

Setting UV Disinfection Cycle Time

Tapping the “Disinfection Cycle Settings” button  takes you to the “Disinfection Cycle Settings” screen, shown in Figure 69 below. From this screen, you can change the default running time of the UV disinfection cycle. This value is used by default when you start the Disinfection cycle by tapping the “UV light” button in the Control Panel Area of the display window.

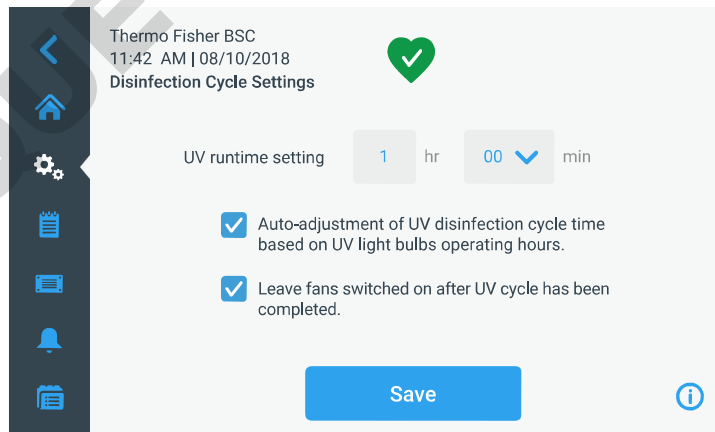



Figure 69 “Disinfection Cycle Settings” Screen

The “Disinfection Cycle Settings” screen displays the following fields:



- “UV runtime setting”: Sets the duration of the UV Disinfection cycle from 0 to 24 hours, with additional intervals of 00, 15, 30, and 45 minutes.

Hours are entered by using a calculator-style keypad, minutes are selectable from a drop-down list.

NOTE The default setting is 1 hour, 00 minutes. 0 hours and 00 minutes is NOT a selectable option.

- *“Auto-adjustment of UV disinfection cycle time based on UV light bulbs operating hours”*: Automatically adjusts cycle time for optimizing the operation of UV bulbs as they age.
- *“Leave fans switched on after UV cycle has been completed”*: keeps the fans running beyond the UV disinfection cycle. You must turn off the fans manually by tapping the “Fan” button .

Proceed as follows to set the Disinfection Cycle time:

1. Tap the “Settings” icon  on the Main Navigation Bar.
2. Tap the “Disinfection Cycle Settings” button  on the “Settings” screen.
3. Tap on the hours field to bring up a “calculator-style” keypad.
4. Enter a duration between 0 and 24 hours.
5. Tap on the arrow in the minutes field and choose 00, 15, 30, or 45 minutes.
6. If you wish to keep the fans running after the disinfection cycle, tap on the checkbox *“Leave fans switched on after UV cycle has been completed”*.
7. When you are done choosing the default cycle time, tap the “Save” button.

NOTE Some of these elements are also available as shortcuts in the main navigation bar.

A pop-up window appears stating that *“Your settings have been saved.”*. If a disinfection cycle is active at this time, you will be asked whether you would like to apply the changes to the current cycle. A header in the top left corner states: *“Settings Saved”*.

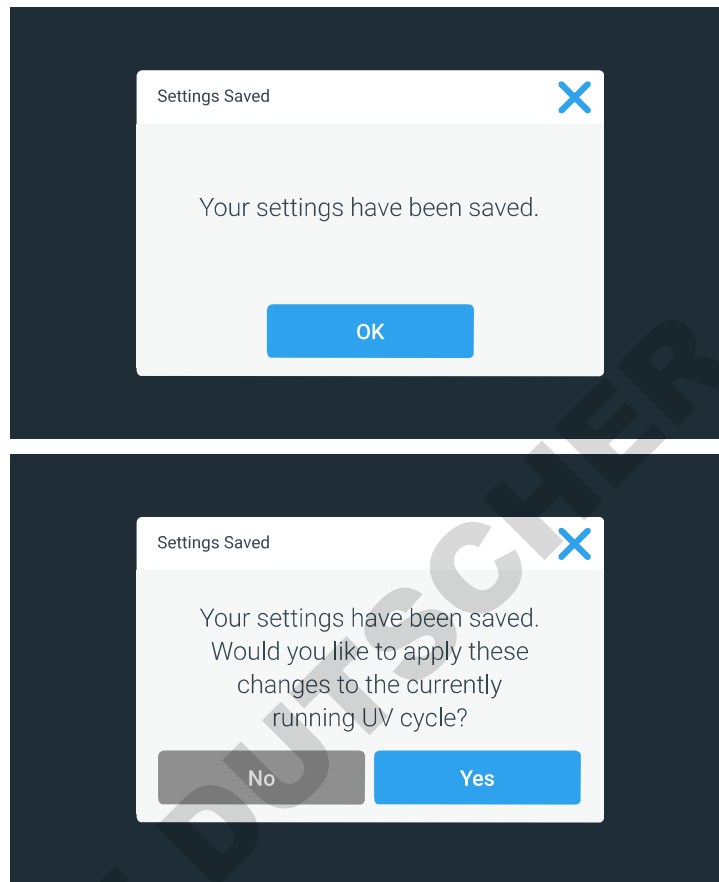

Figure 70 “Settings Saved” Pop-up Windows for Disinfection Cycle Settings

8. Tap the “Yes” button to apply the changes and close the window.

NOTE The window will close automatically after 5 seconds if you do not tap the “Yes” button.

You will be returned to the “Settings” screen.

NOTE If you have entered this screen by tapping the “UV” button on the Main Navigation Bar while the UV disinfection cycle was running, you will be returned to the home screen instead.

Display Settings

Tapping the “Display Settings” button  on the “Settings” screen takes you to the “Display Settings” screen shown in Figure 71.

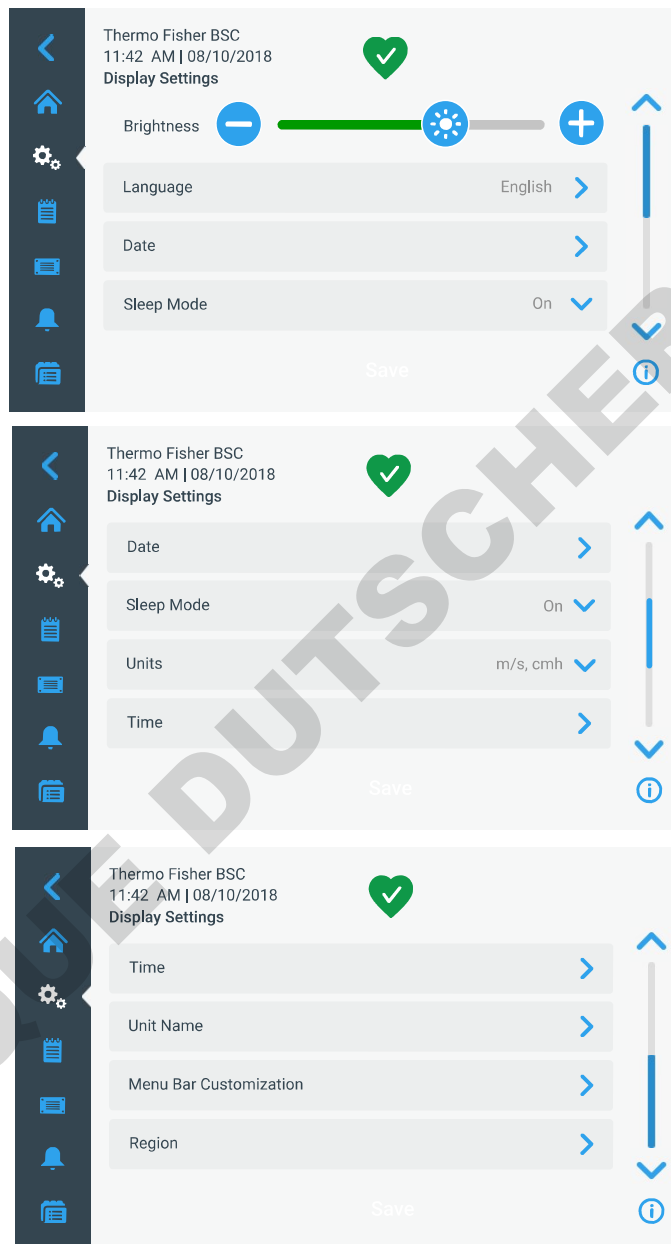

Figure 71 “Display Settings” Screen

The “Display Settings” screen lets you make and/or select the following settings:



- “Brightness”; see “Setting Brightness” on page 78
- “Language”; see “Setting the Display Language” on page 78
- “Date”; see “Setting the Date” on page 79
- “Sleep Mode”; see “Activating / Deactivating Sleep Mode” on page 82
- “Units” (of Measurement); see “Setting Units of Measurement” on page 82

- “Time”; see “Setting the Time of Day” on page 80
- “Unit Name”; see “Setting the Unit Name” on page 83
- “Menu Bar Customization”; see “Customizing the Menu Bar” on page 84
- “Region”; see “Setting the Region” on page 85

Setting Brightness

Brightness is set on the main “Display Settings” screen shown in Figure 71.

Proceed as follows to change brightness of the screen:

1. Tap the “Settings” icon  on the Main Navigation Bar.
2. Tap the “Display Settings” button  on the “Settings” screen.
3. Tap the “Brightness” button on the “Display Settings” screen.
4. Drag the “Brightness” slider button to the right or to the left, or tap the plus (“+”) or (“-”) button to increase or decrease.

If you have made any changes, the “Save” button appears at the bottom of the screen.

5. When you are done adjusting brightness, tap the “Save” button.
6. To commit the changes, tap the “OK” button in the pop-up window that appears (see “Saving Changes” on page 95).

You will be returned to the “Display Settings” screen.

Setting the Display Language

The “Language” button on the “Display Settings” screen opens the “Language” screen where you may choose a display language of your choice. This setting overwrites the display language selection made during the initial setup, as described in the section “Initial Setup” on page 37.

Proceed as follows to set the display language:

1. Tap the “Settings” icon  on the Main Navigation Bar.
2. Tap the “Display Settings” button  on the “Settings” screen.
3. Tap the “Language” button on the “Display Settings” screen.

The “Language” screen appears with a wheel picker, prompting you to choose a display language, as shown in Figure 72 below.



Figure 72 “Display Settings” Screen: “Language” Screen



4. Tap the up/down arrows or swipe your finger across the wheel up or down to set the language (default is English).
If you have made any changes, the “Save” button appears at the bottom of the screen.
5. When you are done choosing the language, tap the “Save” button.
6. To commit the changes, tap the “OK” button in the pop-up window that appears (see “Saving Changes” on page 95).

You will be returned to the “Display Settings” screen.

Setting the Date

The “Date” button in the “Display Settings” screen opens the “Date” screen shown in Figure 73 below. The “Date” screen lets you set the date that appears in a date field in the Info & Health Status Area at the top of all screens.

Proceed as follows to set the date:

1. Tap the “Settings” icon  on the Main Navigation Bar.
2. Tap the “Display Settings” button  on the “Settings” screen.
3. Tap the “Date” button on the “Display Settings” screen.

The “Date” screen appears with a wheel picker, prompting you to set the date, as shown in Figure 73 below.

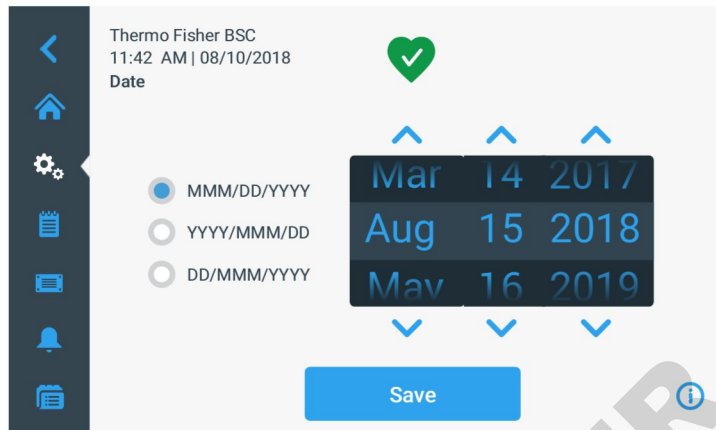

Figure 73 “Display Setting” Screen: “Date” Screen

4. Tap the “MMM/DD/YYYY”, “DD/MMM/YYYY”, or “YYYY/MMM/DD” radio button on the left side of the screen to choose a date format.

The segments of the wheel picker screen are rearranged to reflect the selected date format. For example, if you select the “DD/MMM/YYYY” radio button, the wheel picker will change to 01 | Jan | 2016.

5. Tap the up/down arrows or swipe your finger across the wheel up or down to set the current month, day, and year on each of the three wheel picker segments.

If you have made any changes, the “Save” button appears at the bottom of the screen.



6. When you are done setting the date, tap the “Save” button.
7. To commit the changes, tap the “OK” button in the pop-up window that appears (see “Saving Changes” on page 95).

You will be returned to the “Display Settings” screen.

Setting the Time of Day

The “Time” button in the “Display Settings” screen opens the “Time” screen shown in Figure 74 below. The “Time” screen lets you set the time of day that appears in a time field in the Info & Health Status Area at the top of all screens.

Proceed as follows to set the time:

1. Tap the “Settings” icon  on the Main Navigation Bar.
2. Tap the “Display Settings” button  on the “Settings” screen.
3. Tap the “Time” button on the “Display Settings” screen.

The “Time” screen appears with a three-segmented wheel picker, prompting you to set the time of day, as shown in Figure 74 below.

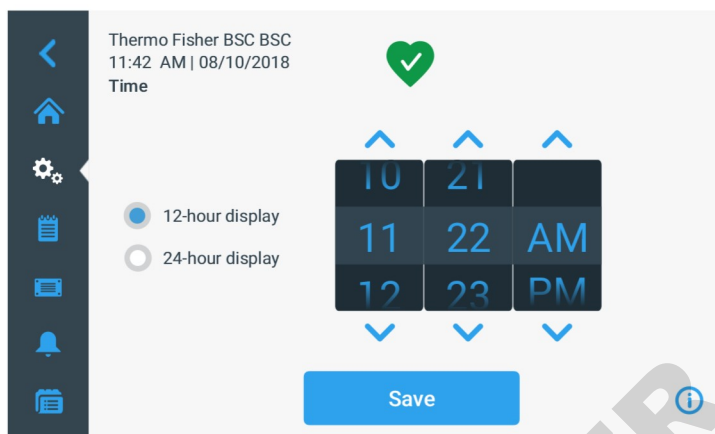

Figure 74 “Display Setting” Screen: “Time” Screen with 12-hour AM/PM Format

4. If desired, tap the “24-hour display” radio button on the left side of the screen to choose the 24-hour time format. (Default time format is AM/PM, 12-hour format.)

The segments of the wheel picker screen are rearranged to reflect the 24-hour time format, as shown in Figure 75 below.

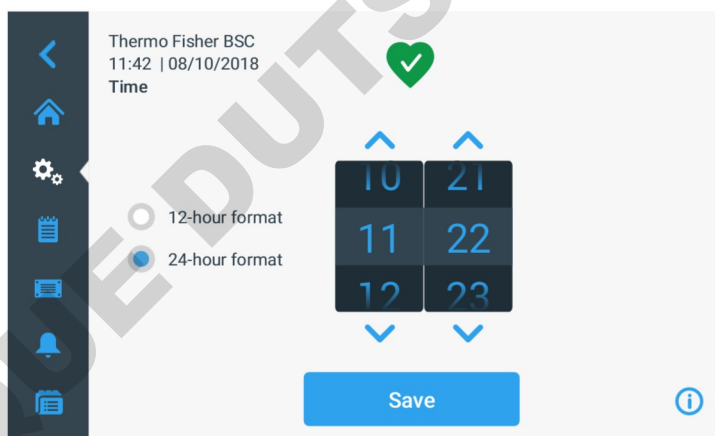

Figure 75 “Display Setting” Screen: “Time” Screen with 24-hour Format

5. Tap the up/down arrows or swipe your finger across each wheel up or down to set the current time in hours and minutes.



If you have made any changes, the “Save” button appears at the bottom of the screen.

6. When you are done setting the time of day, tap the “Save” button.
7. To commit the changes, tap the “OK” button in the pop-up window that appears (see “Saving Changes” on page 95).

You will be returned to the “Display Settings” screen.

Activating / Deactivating Sleep Mode

Proceed as follows to activate/deactivate Sleep Mode (see “Sleep Mode” on page 53):

1. Tap the “Settings” icon  on the Main Navigation Bar.
2. Tap the “Display Settings” button  on the “Settings” screen.
3. Tap the “Sleep Mode” dropdown list on the “Display Settings” screen.

The dropdown list is expanded and displays its options, as shown in Figure 76 below.

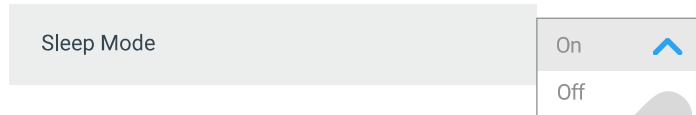

Figure 76 “Sleep Mode” Dropdown Menu



4. Choose either “On” or “Off” for activating or deactivating the Sleep Mode.
If you have made any changes, the “Save” button appears at the bottom of the screen.
5. When you are done choosing the Sleep Mode option, tap the “Save” button.
6. To commit the changes, tap the “OK” button in the pop-up window that appears (see “Saving Changes” on page 95).
7. You will be returned to the “Display Settings” screen.

Setting Units of Measurement

The units of measurement for airflow can be chosen directly on the main “Display Settings” screen shown in Figure 71. A dropdown list lets you chose between:

- metric units: m/s (meters per second), cmh (cubic meters per hour)
- imperial units: fpm (feet per minute), cfm (cubic feet per minute)

Proceed as follows to switch units of measurement:

1. Tap the “Settings” icon  on the Main Navigation Bar.
2. Tap the “Display Settings” button  on the “Settings” screen.
3. Tap the “Units” dropdown list on the “Display Settings” screen.

The dropdown list is expanded and displays its options, as shown in Figure 77 below.

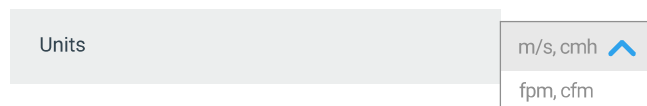

Figure 77 “Units” Dropdown Menu

4. Choose either “m/s, cmh” for metric units or “fpm, cfm” for imperial units (default is metric).
If you have made any changes, the “Save” button appears at the bottom of the screen.
5. When you are done choosing the units of measurement, tap the “Save” button.

- To commit the changes, tap the “OK” button in the pop-up window that appears (see “Saving Changes” on page 95).

You will be returned to the “Display Settings” screen.

Setting the Unit Name

You may set a name for the unit that will be displayed above the time/date field in the Info & Health Status Area at the top of all screens.

Proceed as follows to edit the name of the unit:

- Tap the “Settings” icon  on the Main Navigation Bar.
- Tap the “Display Settings” button  on the “Settings” screen.
- Tap the “Unit Name” button on the “Display Settings” screen.

The “Unit Name” screen appears, as shown in Figure 78 below.

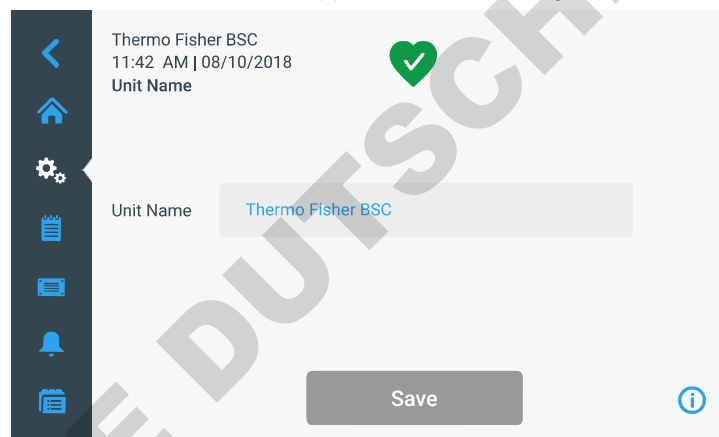

Figure 78 “Display Settings” Screen: “Unit Name” Screen

- Inspect the “Unit name” field:
 - If no unit name has been previously set, the “Unit Name” field will read *“Tap to enter”*.
 - If a unit name has been previously set, that name appears in the *“Unit Name”* field.
- Tap on the *“Unit Name”* field to display a full keypad, as shown in Figure 79 below.
 - If no unit name has been previously set, a cursor will appear in the *“Unit Name”* field and prompt you to start typing.

If a unit name has been previously set, that name will be selected for overwriting.

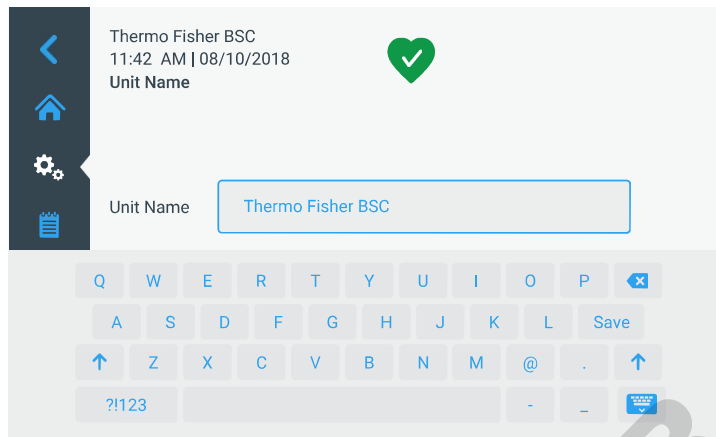

Figure 79 “Display Settings” Screen: “Unit Name” Screen



6. Type the desired unit name.
7. When you are done typing, do one of the following:
 - a. Tap the “Save” button on the keypad.
 - b. Tap anywhere outside of the keypad and the “User Name” field to hide the keypad, then tap the “Save” button at the bottom of the screen.
8. To commit the changes, tap the “OK” button in the pop-up window that appears (see “Saving Changes” on page 95).

You will be returned to the “Display Settings” screen.

Customizing the Menu Bar

The “Menu Bar Customization” screen shown in Figure 80 lets you swap the three bottom icons in the left-hand Main Navigation Bar.

Proceed as follows to swap any of the bottom icons in the left-hand Main Navigation Bar:

1. Tap the “Settings” icon  on the Main Navigation Bar.
2. Tap the “Display Settings” button  on the “Settings” screen.
3. Tap the “Menu Bar Customization” button on the “Display Settings” screen.

The “Menu Bar Customization” screen appears, as shown in Figure 80 below.

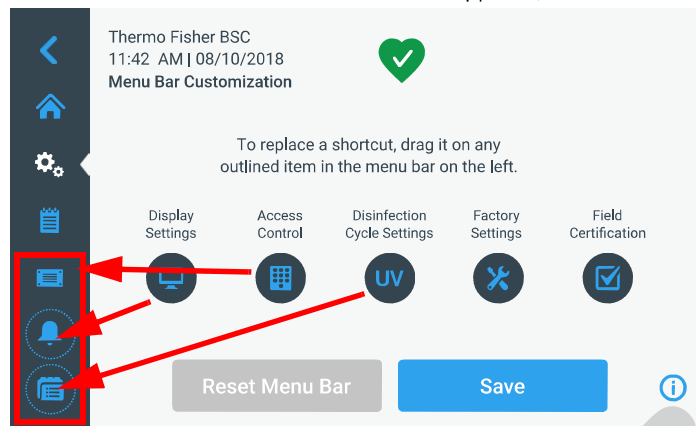

Figure 80 “Display Setting” Screen: “Menu Bar Customization” Screen with Icon Swapping Options

4. Tap one of the five icons in the center of the “Menu Bar Customization” screen.
5. Drag the icon on top of one of the three highlighted icons in the left-hand Main Navigation Bar.

The icon you have just dragged will appear in the Main Navigation Bar. The icon previously displayed in the Main Navigation Bar will appear among the five icons in the center of the screen, along with the pertinent text label.

If you have made any changes, the “Save” button appears at the bottom of the screen.

6. When you are done customizing the Main Navigation Bar, tap the “Save” button.
7. To commit the changes, tap the “OK” button in the pop-up window that appears (see “Saving Changes” on page 95).

You will be returned to the “Display Settings” screen.

Setting the Region

The “Region” button in the “Display Settings” screen opens the “Region” screen shown in Figure 81 below. The “Region” screen lets you enter a city and country combination.

Proceed as follows to set the region:

1. Tap the “Settings” icon  on the Main Navigation Bar.
2. Tap the “Display Settings” button  on the “Settings” screen.
3. Tap the “Region” button on the “Display Settings” screen.

The “Region” screen appears. Enter the name of the city or country and select from the list of suggestions displayed (see “Appendix: City Time Zones” on page 149):

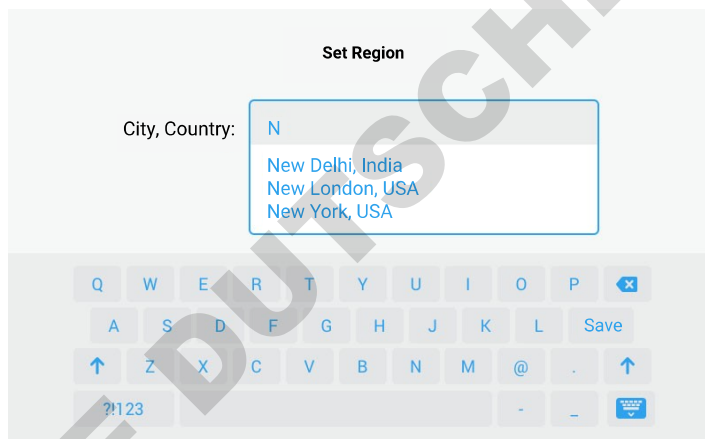
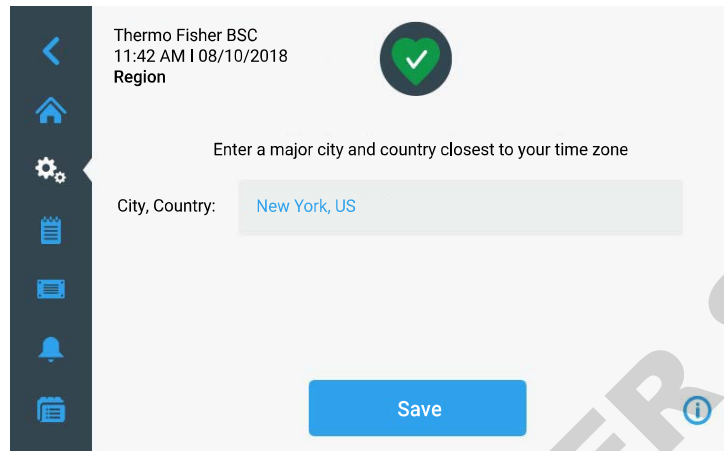



Figure 81 “Display Setting” Screen: “Region” Screen

You can tap the field to display the keyboard. Then you can start typing your city. As you type, the field auto-suggests the city/country combinations. You may either continue to type to narrow the suggestions being presented, or tap on one of the suggestions to select.

Press the “Save” button to save your changes and return to the “Display Settings” screen. Once you tap the “Save” button, a pop-up window overlay screen appears stating: Your settings have been saved.

Programs

Tapping the “Programs” button in the “Settings” screen takes you to the “Programs” screen shown in Figure 82. The “Programs” screen lets you set up the “AutoStart”  and “AutoStop” buttons  that switch the biological safety cabinet on and off, respectively.

The settings you make in these screens determine which of the unit's functions are turned on by default when you press the "AutoStart" button  or which functions are turned off when you press the "AutoStop" button  in the Control Panel.

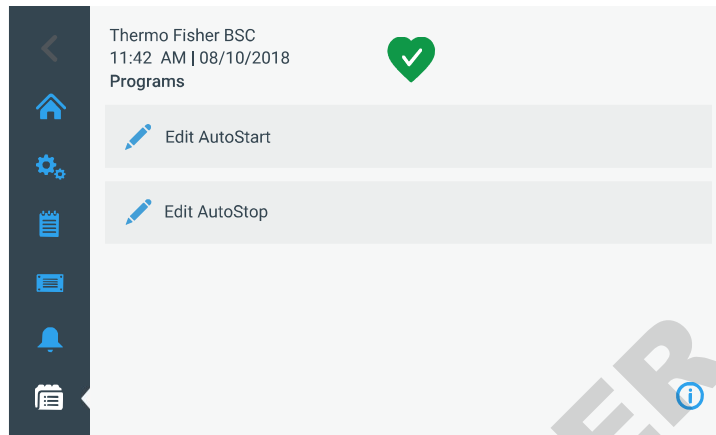

Figure 82 "Programs" Screen

The "Programs" screen offers two menu buttons that can be tapped to open further screens with editable settings for the auto-start and auto-stop timers.

Setting up AutoStart

Proceed as follows to set up the biological safety cabinet for AutoStart:

1. Tap the "Settings" icon  on the Main Navigation Bar, followed by the "Programs" button  on the "Settings" screen.

Alternatively, you can also tap the "Programs" icon  on the Main Navigation Bar.

2. Tap the "Edit AutoStart" button on the "Programs" screen.

Doing so will open up the “Edit AutoStart” screen shown in Figure 83 below. By default, the “Edit AutoStart” screen comes up with all four checkboxes already selected, as shown in the top image in Figure 83.

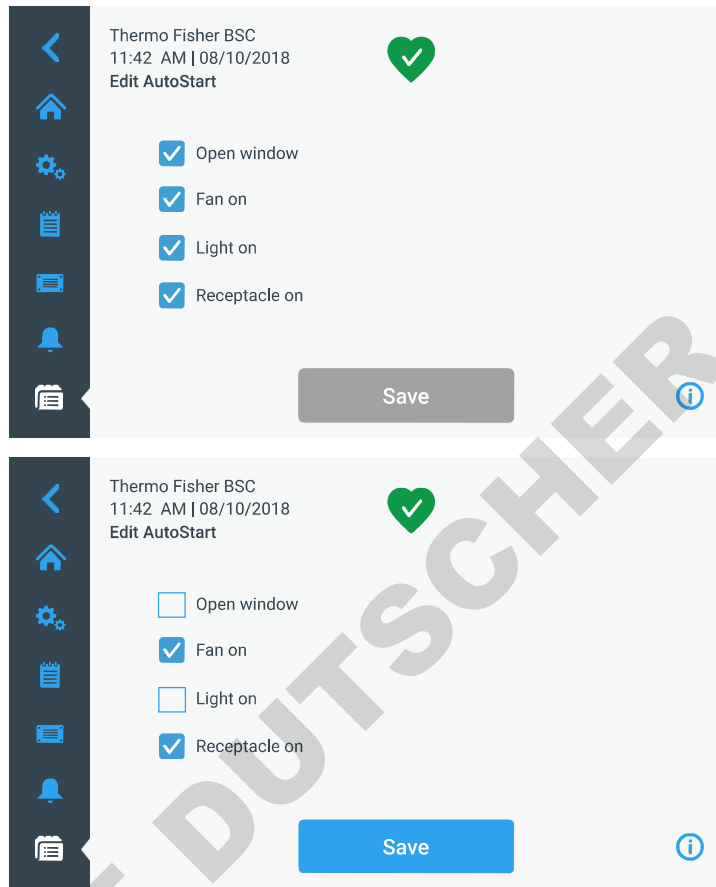





Figure 83 “Programs” Screen: “Edit AutoStart” Screen

3. Tap to select or deselect the option checkboxes as required:
 - “Open window” will automatically open the window to the working position when the “AutoStart” button  is pressed.
 - “Fan on” turns on the fans when the “AutoStart” button  is pressed.
 - “Light on” turns on the sample chamber illumination when the “AutoStart” button  is pressed.
 - “Receptacle on” applies electrical power to the power outlets in the sample chamber when the “AutoStart” button  is pressed.



If you have made any changes, the “Save” button appears at the bottom of the screen, as shown in the bottom image in Figure 83.

4. When you are done choosing AutoStart options, tap the “Save” button.
5. To commit the changes, tap the “OK” button in the pop-up window that appears (see “Saving Changes” on page 95).

You will be returned to the “Settings” screen.

Setting up AutoStop

Proceed as follows to set up the biological safety cabinet for AutoStop:

1. Tap the “Settings” icon  on the Main Navigation Bar, followed by the “Programs” button  on the “Settings” screen.

Alternatively, you can also tap the “Programs” icon  on the Main Navigation Bar.

2. Tap the “Edit AutoStop” button on the “Programs” screen.

Doing so will open up the “Edit AutoStop” screen shown in Figure 84 below. By default, the “Edit AutoStop” screen comes up with the “Fan off after UV” option and all remaining checkboxes selected (top image in Figure 84).





Figure 84 “Programs” Screen: “Edit AutoStop” Screen

3. Tap to select one of three radio buttons to determine whether and when the fans should be turned off after the “AutoStop” button  has been pressed:
 - “Fan off after UV” selects the “UV on” option to have the biological safety cabinet run UV disinfection after AutoStop.
 - “Fan immediately off”
 - “Leave fan on”
4. Tap to select or deselect any of the four checkboxes as required:

- “Close window” will automatically close the window.

NOTE If the window is set to close as part of AutoStop, you must press and hold the “AutoStop” button  while the window is closing. This is a safety feature.

- “Light off” turns off the sample chamber illumination when the “AutoStop” button  is pressed.
- “Receptacle off” shuts off electrical power to the power outlets in the sample chamber when the “AutoStop” button  is pressed.
- “UV on” starts the UV disinfection cycle when the “AutoStop” button  is pressed.

The “UV on” setting has additional parameters. You may set:

- Time to run UV in hours (1-24 hours) and minutes (00, 15, 30, 45 minutes). You may change the hours by tapping in the hour field and entering a number from 1 to 24 in the calculator style keypad. You may change the minutes by selecting any of these four options from a dropdown list: 00, 15, 30, 45.
- You may also want to keep the fans running after the UV cycle is complete by checking the “Leave fan on” option explained further above. Default is unchecked.

If you have made any changes, the “Save” button appears at the bottom of the screen.

5. When you are done choosing AutoStop options, tap the “Save” button (bottom image in Figure 84).
6. To commit the changes, tap the “OK” button in the pop-up window that appears (see “Saving Changes” on page 95).

You will be returned to the “Settings” screen.

Alarms and Alerts

Tapping the “Alarms and Alerts” button  on the “Settings” screen takes you to the “Alarms and Alerts” screen, shown in Figure 85 below.

From the “Alarms and Alerts” screen, you may change the volume, tone, and timing of several audible alarms and alerts emitted by the biological safety cabinet.

Selections are made by tapping dropdown lists on the screen. You may change one, several, or all of the dropdown lists before committing your selections with the “Save” button.



Figure 85 “Alarms and Alerts” Screen

Alarm Volume

You may change the volume of the alarm tone directly on the main “Alarms and Alerts” screen by just tapping on the dropdown list labeled “Alarm Volume” (see Figure 86 below) and selecting one of the four “Off”, “Low”, “Medium”, or “High” options.

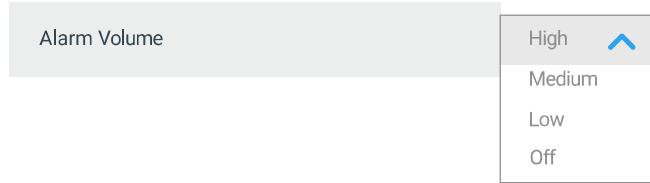





Figure 86 “Alarms and Alerts” Screen: “Alarm Volume” Options



The alarm volume should be adjusted in the “Alarms and Alerts” screen according to the sound level of the environment lab.

Proceed as follows to change the alarm volume:

1. Tap the “Settings” icon  on the Main Navigation Bar.
2. Tap the “Alarms and Alerts” button  on the “Settings” screen.
Alternatively, you can also tap the “Alarms and Alerts” icon  on the Main Navigation Bar to open the “Alarms and Alerts” screen.
3. Tap the “Alarm Volume” dropdown menu and choose an option.
4. Save your changes as explained in the section “Saving Changes” on page 95, or change any other desired option on the “Alarms and Alerts” screen.

Window Alarm Tone

You may change the alarm tone for the front window directly on the main “Alarms and Alerts” screen by just tapping on the dropdown list labeled “Window Alarm Tone” (see Figure 87 below) and selecting one of the three options.

NOTE The naming of the options may differ in each country.

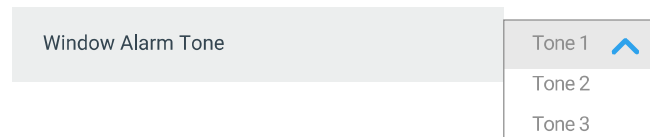





Figure 87 “Alarms and Alerts” Screen: Window Alarm Tone Options

Proceed as follows to change the window alarm tone:

1. Tap the “Settings” icon  on the Main Navigation Bar.
2. Tap the “Alarms and Alerts” button  on the “Settings” screen.

Alternatively, you can also tap the “Alarms and Alerts” icon  on the Main Navigation Bar to open the “Alarms and Alerts” screen.

3. Tap the “Window Alarm Tone” dropdown menu and choose an option.
4. Save your changes as explained in the section “Saving Changes” on page 95, or change any other desired option on the “Alarms and Alerts” screen.

Airflow Alarm Tone

You may change the alarm tone for low or high airflow conditions directly on the main “Alarms and Alerts” screen by just tapping on the dropdown list labeled “Airflow Alarm Tone” (see Figure 87 below) and selecting one of the three options.

NOTE The options may be named differently, depending on the country.

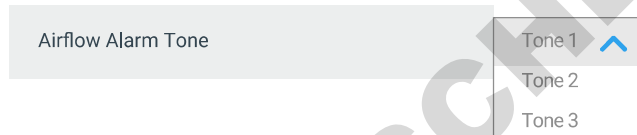





Figure 88 “Alarms and Alerts” Screen: Airflow Alarm Tone Options

Proceed as follows to change the airflow alarm tone:

1. Tap the “Settings” icon  on the Main Navigation Bar.
2. Tap the “Alarms and Alerts” button  on the “Settings” screen.
Alternatively, you can tap the “Alarms and Alerts” icon  on the Main Navigation Bar to open the “Alarms and Alerts” screen.
3. Tap the “Airflow Alarm Tone” dropdown menu and choose an option.
4. Save your changes as explained in the section “Saving Changes” on page 95, or change any other desired option on the “Alarms and Alerts” screen.

Snooze Timeout

You may set the timeout period during which an alarm is temporarily silenced when you press the “Snooze” button directly on the main “Alarms and Alerts” screen. This is done by tapping on the dropdown list labeled “Snooze Timeout” (see Figure 89 below) and selecting one of the periods.

NOTE Applicable BSC standards in effect may not allow temporary muting of audible alarm.

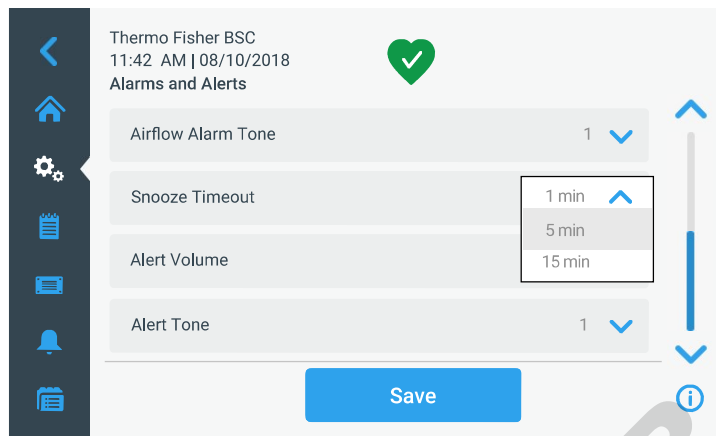





Figure 89 “Alarms and Alerts” Screen with Snooze Timeout Options expanded

Proceed as follows to change the snooze timeout period:

1. Tap the “Settings” icon  on the Main Navigation Bar.
2. Tap the “Alarms and Alerts” button  on the “Settings” screen.
Alternatively, you can tap the “Alarms and Alerts” icon  on the Main Navigation Bar to open the “Alarms and Alerts” screen.
3. Tap the “Snooze Timeout” dropdown menu and choose an option.

NOTE The default option is 5 min.

The time period in the “Snooze Timeout” dropdown will change to the new setting.

4. Save your changes as explained in the section “Saving Changes” on page 95, or change any other desired option on the “Alarms and Alerts” screen.

Alert Volume

You may change the volume of the alert tone directly on the main “Alarms and Alerts” screen by just tapping on the dropdown list labeled “Alert Volume” (see Figure 90 below) and selecting one of the Low, Medium, or High options.

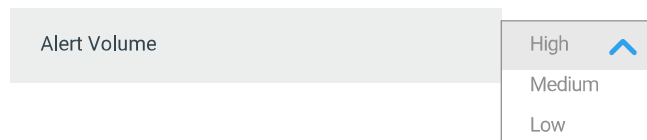



Figure 90 “Alarms and Alerts” Screen: Alert Volume Options

Proceed as follows to change the alert volume:

1. Tap the “Settings” icon  on the Main Navigation Bar.
2. Tap the “Alarms and Alerts” button  on the “Settings” screen.

Alternatively, you can tap the “Alarms and Alerts” icon  on the Main Navigation Bar to open the “Alarms and Alerts” screen.

3. Tap the “Alert Volume” dropdown menu and choose an option.
4. Save your changes as explained in the section “Saving Changes” on page 95, or change any other desired option on the “Alarms and Alerts” screen.

Alert Tone

You may choose an alert tone directly on the main “Alarms and Alerts” screen by just tapping on the dropdown list labeled “Alert Tone” (see Figure 91 below) and selecting one of the three options.

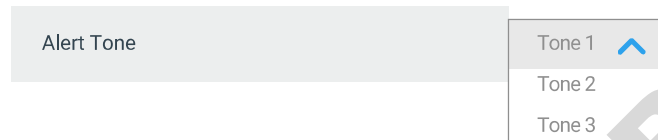



Figure 91 “Alarms and Alerts” Screen: Alert Tone Options

Proceed as follows to change the alert tone:

1. Tap the “Settings” icon  on the Main Navigation Bar.
2. Tap the “Alarms and Alerts” button  on the “Settings” screen.

Alternatively, you can tap the “Alarms and Alerts” icon  on the Main Navigation Bar to open the “Alarms and Alerts” screen.

3. Tap the “Alert Tone” dropdown menu and choose an option.
4. Save your changes as explained in the section “Saving Changes” on page 95, or change any other desired option on the “Alarms and Alerts” screen.

Saving Changes

The “Save” button at the bottom of the screen lets you commit any changes you have made to the setup. The “Save” button will appear as soon as you make any changes to any of the dropdowns on the screen.

1. When you are done making settings, tap the “Save” button.

A pop-up window appears, stating that *“Your settings have been saved.”*. A header in the top left corner states: *“Settings saved”*.

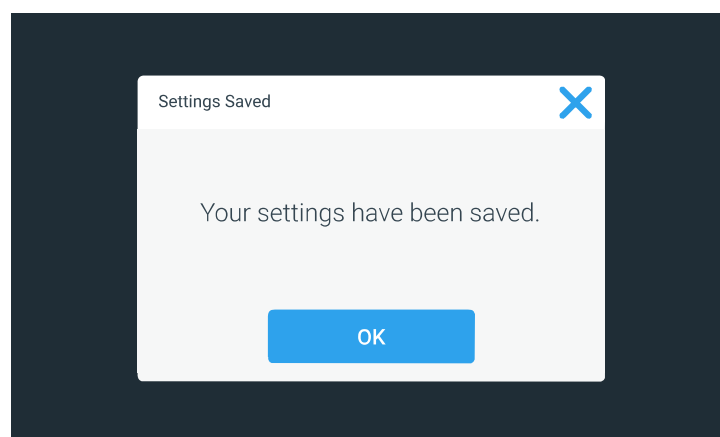

Figure 92 “Settings Saved” Screen

2. Tap the “OK” button to apply the changes and close the window.

NOTE The window will close automatically after 5 seconds if you do not tap the “OK” button.

3. If you wish to cancel saving, tap the X icon in the top right corner of the pop-up window.

Another pop-up window appears, asking whether you are sure about exiting. You may then choose to tap the “Discard Changes” button and cancel saving for good, or tap the “Save Changes” button and continue saving.

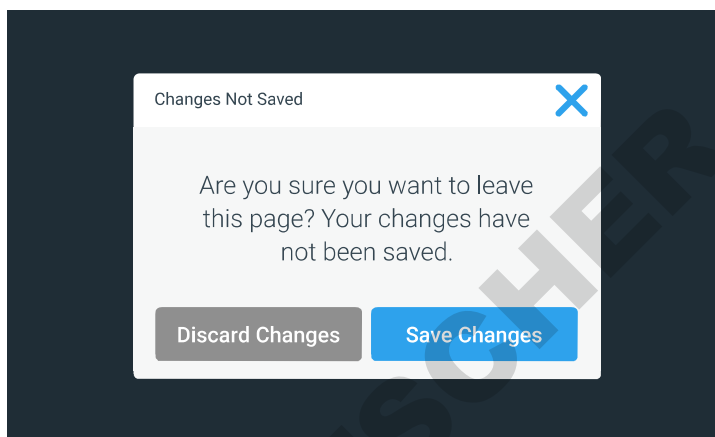

Figure 93 “Changes not Saved” Message

You will be returned to the “Settings” screen.

Data Plate

Tapping the “Data Plate” icon  on the Main Navigation Bar takes you to the “Data Plate” screen shown in Figure 94. The “Data Plate” screen displays pertinent information about the biological safety cabinet, including:

- Serial no.
- Order no.
- Release
- Firmware release
- Addon board release

All information on the first-level “Data Plate” screen is read-only and cannot be edited.

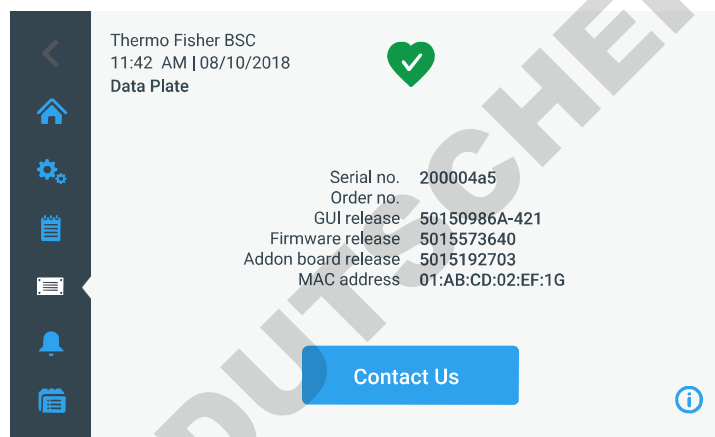

Figure 94 “Data Plate” Screen

Viewing and Editing Contact Information

Tapping the “Contact Us” button on the “Data Plate” screen takes the user to the “Contact Us” screen shown in Figure 95. The “Contact Us” screen lists addresses and telephone numbers of Thermo Scientific service organizations. You may view and/or edit contact information for Thermo Fisher Scientific to keep the contact information in the unit up-to-date.

The page is divided into three separate boxes with headers for: US, Europe, and Asia.

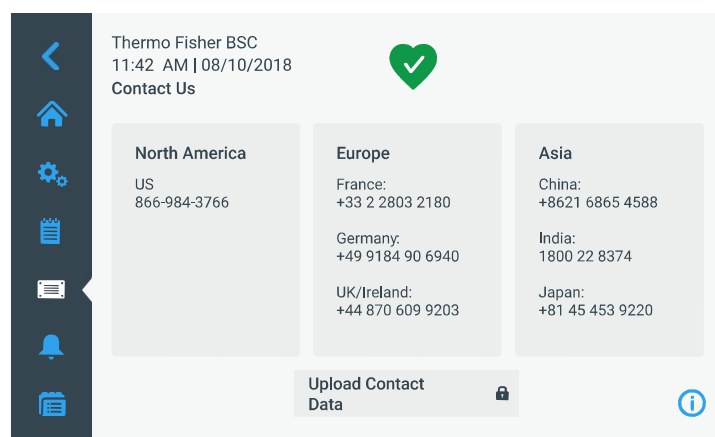

Figure 95 “Data Plate” Screen: “Contact Us” Screen

You may tap into the three fields to edit or add text. A keyboard (see Figure 96) appears when the user taps into any of the boxes.

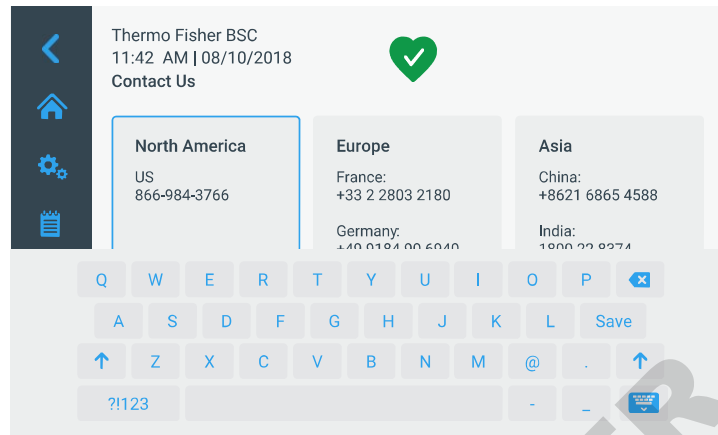

Figure 96 “Data Plate” Screen: Editing the “Contact Us” Screen

The headers are not editable. You can use the up/down arrows to scroll through the box if there is more content than can be seen on one screen, or use a swiping gesture to scroll the box.

Connectivity

Connectivity requirements

There are two requirements that must be observed to take full advantage of your Herasafe/Maxisafe 2030i’s connectivity options:

1. The Herasafe/Maxisafe 2030i is designed to connect to the Thermo Fisher Cloud exclusively through a WiFi (wireless) network. The lowest acceptable signal strength is 75 dBm.
 - a. Consult with your IT department about the correct wireless network and password to use
 - b. To safeguard your data against unauthorized access, make sure you use a WiFi Protected Access network with state-of-the-art data encryption, as outlined further below under “WiFi Network Specifications”
 - c. Make sure that your safety cabinet is within the coverage area of the WiFi network, that there is sufficient WiFi signal strength at the location of your safety cabinet and that there is no radio interference from adjacent communications equipment to your WiFi network
 - d. Ensure that the date and time settings of your safety cabinet are in sync with the current date and time at your location
 - e. If your Herasafe/Maxisafe 2030i is unable to establish the WiFi connection, check whether you are using the correct WiFi network and password, then repeat the connection attempt
2. A Thermo Fisher Cloud account.
 - a. It must be ensured that the customer’s IT network does not block ports 443, 22, 1023 and ICMP Ping. These ports are necessary to establish a cloud connection.

- b. If you do not already have a Thermo Fisher Cloud account open the URL below using a web browser:

<https://www.thermofisher.com/cloud>

- c. Choose the “create an account” option.

WiFi Network Specifications

Parameter	Specification
WiFi protocol	802.11b/g/n
WiFi Security	WEP, WPA PSK, WPA2 PSK
WiFi band	2.4 GHz
Firewall Ports that must open	443, 22, 1023 and ICMP Ping

NOTE

Thermo Fisher Cloud-connected devices do not support the use of proxy servers and enterprise networks which require identity/username for internet access. The entry of username/password via a Web browser is not supported either.

NOTE Connectivity with WiFi option

The connectivity option is only available in the EU, US and CAN regions. WiFi figures are only displayed if the region set in the “Region” screen (see “Initial Setup” on page 37) is allowed.

If the customer uses WiFi stick other than the one supplied with the device or sold by Thermo as a spare part, the device will lose its approval. Use only original parts.

For the WiFi setup connection to Thermo Fisher Cloud, the customer's IT department should be consulted.

Tapping the “Connectivity” button  in the “Settings” screen takes you to the “Connectivity” screen shown in Figure 97. If the unit includes a WiFi module, but the unit has not been connected to a WiFi (wireless) network, the following “Connectivity” screen is displayed.

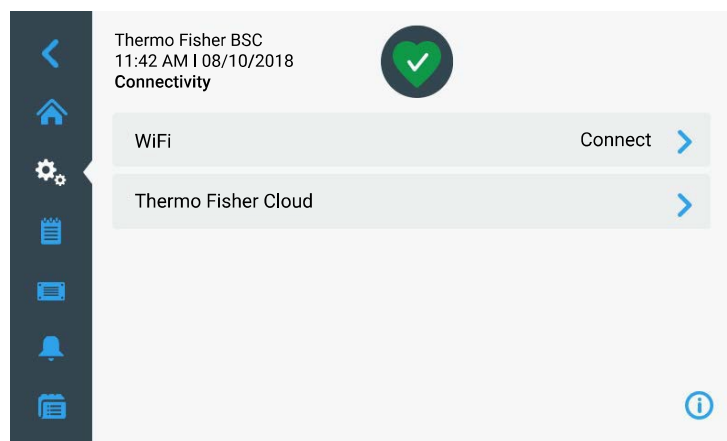

Figure 97 “Connectivity” Screen

If the unit is actively connected to a WiFi network the name of the network is displayed as in the following screen:



Figure 98 “Connectivity” Screen with Network Name Displayed

New WiFi Connection

If you are not actively connected to a WiFi network because you haven't set up a network, the following screen is displayed when you tap on the “WiFi” Connect button:

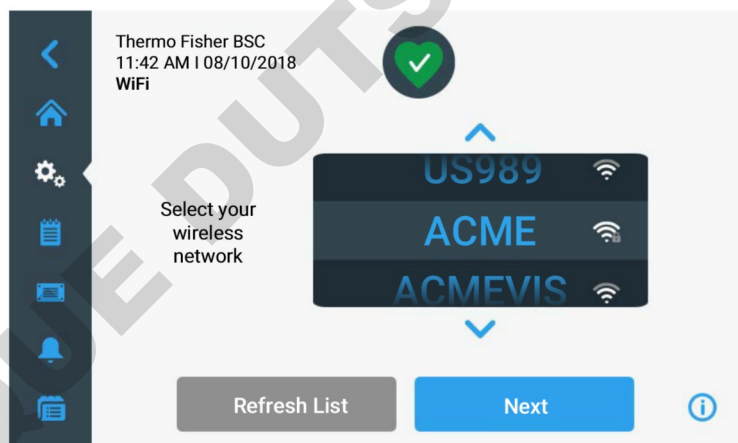

Figure 99 “WiFi” Screen

From this screen, all available networks are shown in the wheel picker format. They are shown along with their signal strength and whether the network is secured requiring a password.

You may tap on the “Refresh List” button to refresh the list, if your network isn't displayed. You can use either the arrows above the wheel picker or the wheel picker itself to scroll through the available networks. Once you have highlighted the network you would like to join, tap the “Next” button.

Note, there can only be max. 24 characters for the WiFi wheel picker. An ellipsis (counts as one character) is displayed if the entry is longer than 24 characters.

If the network does not require a password and the connection is successful, the following pop-up window message is displayed:

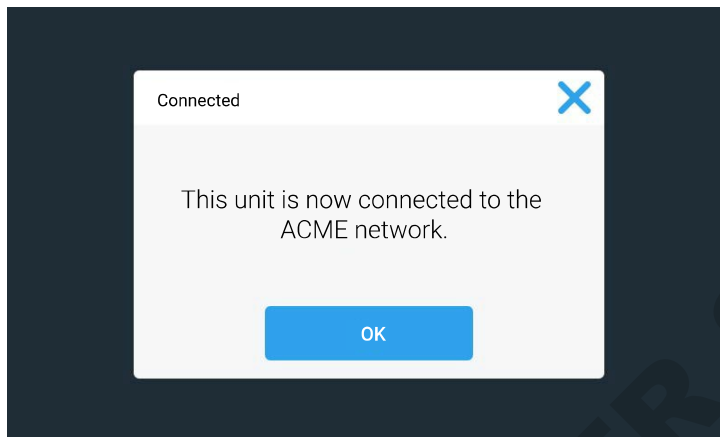

Figure 100 Screen with Network Connection Message

If the unit requires a password to join, the following screen is displayed:

Thermo Fisher BSC
11:42 AM | 08/10/2018
WiFi Edit

Status: Connected

Network: ACME

Security: WPA2 PSK

Password: *****

Type: DHCP Static/Manual

IP Address: 123.456.789.0

Netmask: 123.456.789.0

Gateway: 123.456.789.0

DNS1: 123.456.789.0

DNS2: Tap to enter

Mac Address: 12:AB:CD:34:EF:56

Forget this Network Save

Figure 101 “WiFi” Screen with Password Required

You may use the “Back” button to return to the screen with the wheel picker to select another network, or you may enter the network password and tap the “Join” button to join the network.

Select DHCP to get the address from the DHCP server.

Tapping the eye icon next to the password field will toggle the password view from asterisks (default) to actual text if you have a complicated password and you would like to confirm you have entered it correctly.

If the password is accepted and the unit is able to join the network, the following pop-up window is displayed:

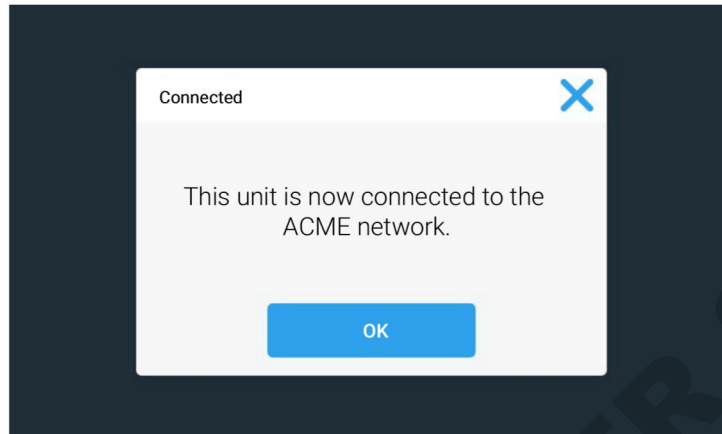

Figure 102 Network Connection Message

Tapping the “OK” button or the X icon in the top right corner will close the pop-up window and the display returns to the “Connectivity” screen. The “Connectivity” screen displays the WiFi network name in the WiFi button.

When unsuccessful, an error message appears on the screen of the device, detailing the nature of the problem. Use this information for troubleshooting the connection problem, then try again.

Joining a Different Type of WiFi Network

If the network you would like to join is not displayed in the wheel-picker list, you may choose “Join Other” and tap the “Next” at the bottom of the screen. If the network cannot be seen, this may also be due to the signal strength being too weak:

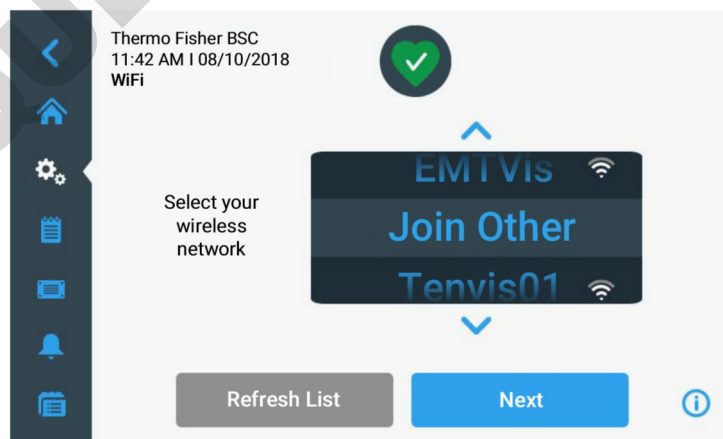
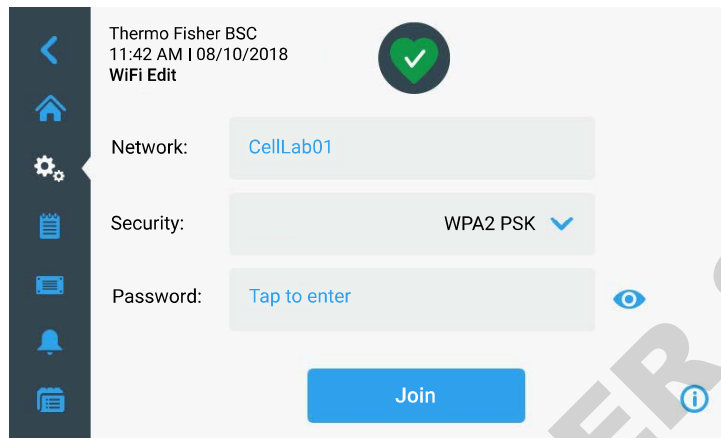
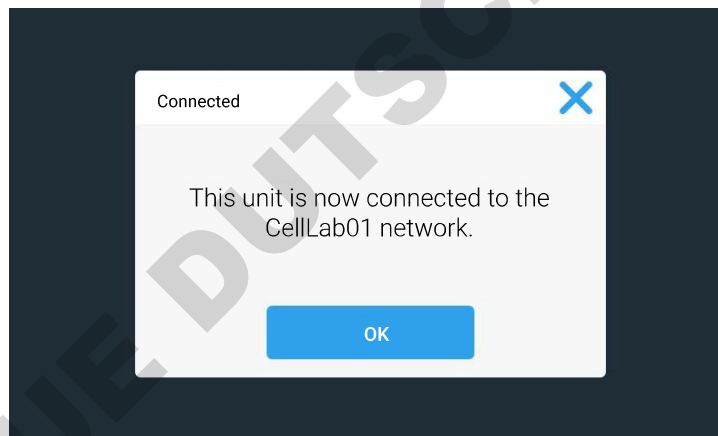

Figure 103 “WiFi” Screen - Join Other

On the following screen, you will be prompted to enter the Network name, choose the type of security from the drop-down menu, and enter the password for the Network (if a secure network requiring a password):



Once all fields have been entered, you must tap the “Join” button. If the unit successfully joined the network, the following pop-up window message is displayed:



Note the “CellLab01” would be the name of the network. Tapping the “OK” button or the X icon in the top right corner will close the pop-up window and the display returns to the “Connectivity” screen. The “Connectivity” screen displays the WiFi network name in the WiFi button.

When unsuccessful, an error message appears on the screen of the device, detailing the nature of the problem. Use this information for troubleshooting the connection problem, then try again.

Editing a WiFi Network

If you are connected to a WiFi network and you would like to view or edit the connection, the following visual screen is displayed when you tap on the “WiFi” button:



If the unit is actively connected, the status displays “Connected”. If the unit is not actively connected, the status displays “Disconnected”.

You may tap into the “IP Address” field to manually change the IP Address. If you would like to remove the unit from the selected network, you may tap the “Forget this Network” button. Tapping this button will bring you back to the “Connectivity” screen. If you make a change to this screen, you must tap the “Save” button.

You are shown a Save confirmation screen stating your changes have been saved:

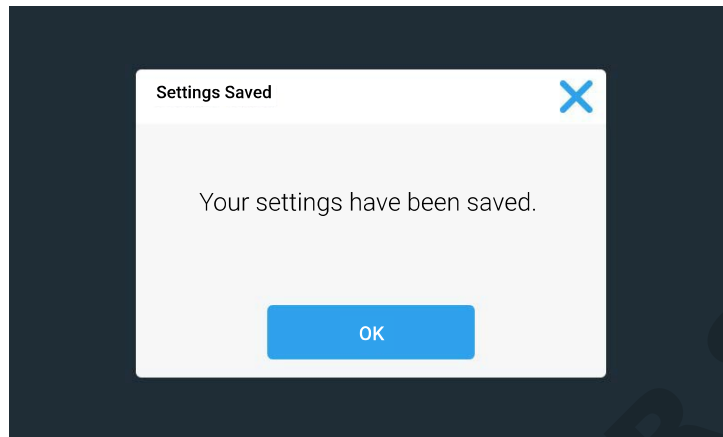

You may tap the "OK" button or the X icon in the top right corner to close this window and return to the "Connectivity" screen.

DHCP and Static/Manual Settings

If required by the network additional fields for DHCP and Static/Manual settings can be shown as in these examples:

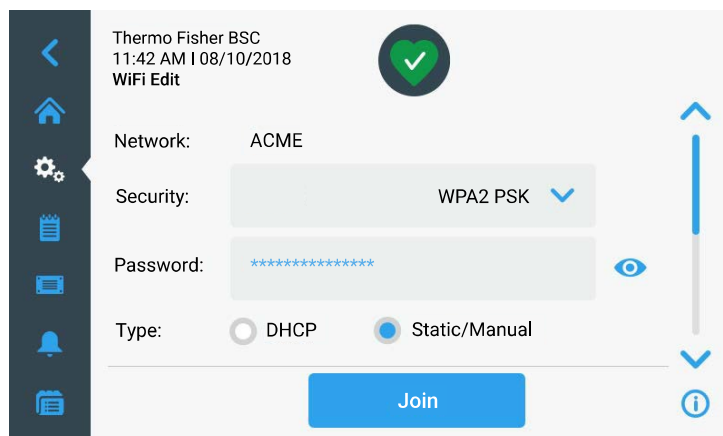
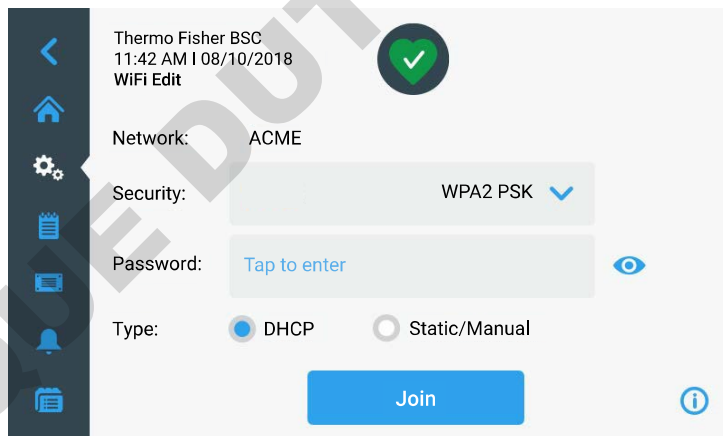

Example showing content below the main screen (scroll to view):

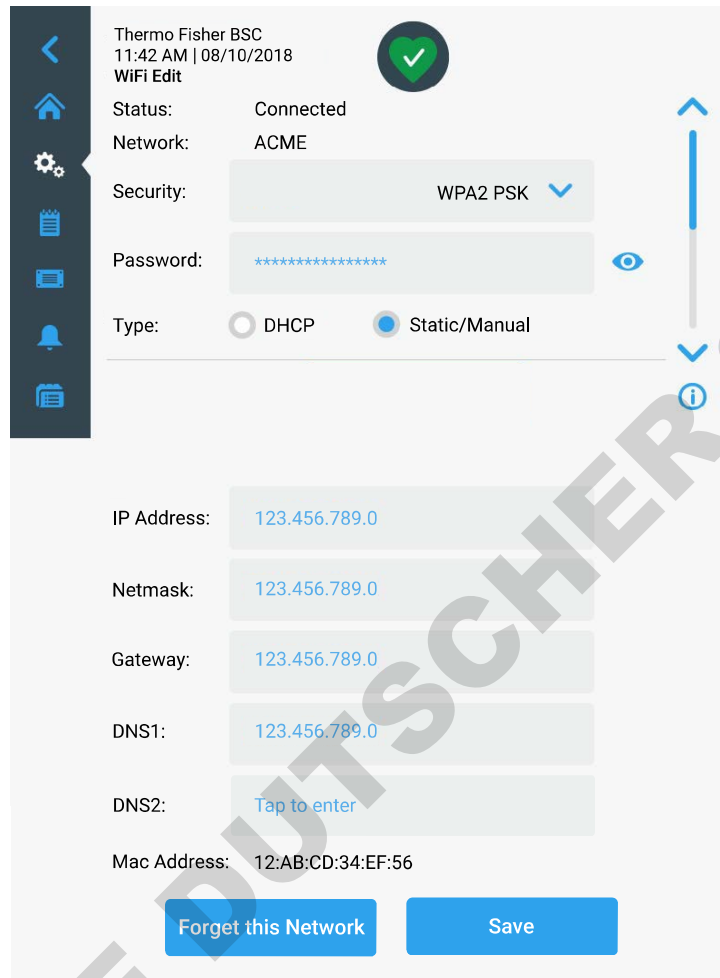

Connecting to the Thermo Fisher Cloud

When the unit has been connected to the WiFi network and you do have an account set up, you may connect your unit to the Thermo Fisher Cloud. Figure 104 shows the “Thermo Fisher Cloud” screen with its three cloud connectivity option boxes. The Cloud icon at the top left of the Main screen must be displayed to perform these actions. This signals that the TFS Cloud is accessible:

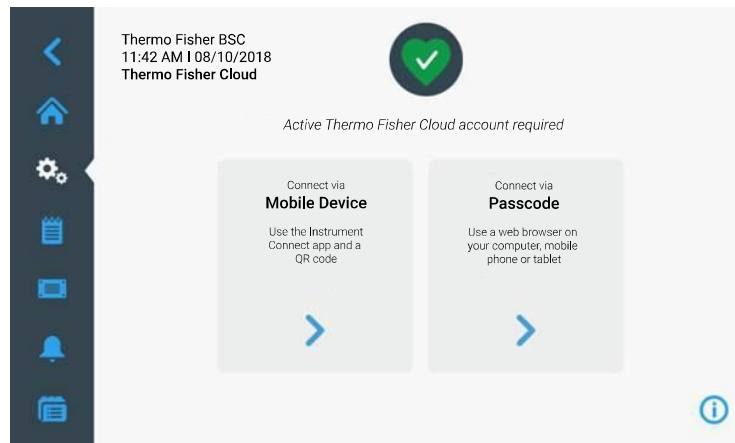
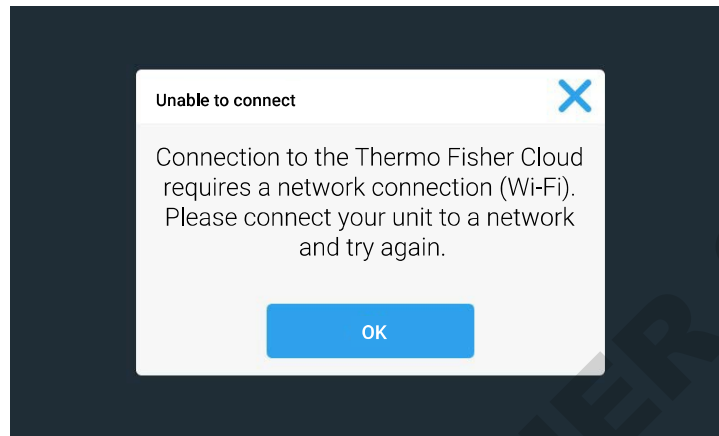

Figure 104 “Thermo Fisher Cloud” Screen

You must have an active Thermo Fisher Cloud account before you can use one of the three methods listed above to connect the unit.

If the unit is not actively connected to a WiFi network, the following screen is displayed:



Connect via Mobile Device

If you tap on the “Connect via Mobile Device” box from the “Thermo Fisher Cloud” screen, the following screen is displayed:

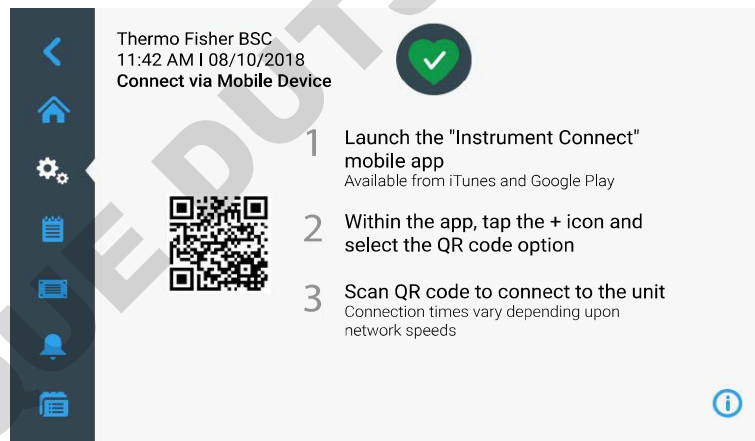

A QR code is generated by the system and displayed on the left side of the screen with text in the right column detailing the steps required by the user to successfully connect the unit to the cloud.

NOTE

The mobile app has limited functionality compared to the web application (URL). For example, it is not possible to implement user management or remove devices from the cloud.

Once you complete the steps successfully and the unit has connected, the following confirmation screen is displayed:

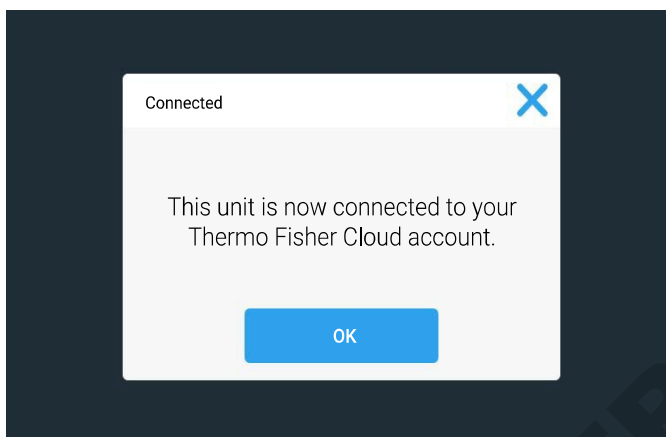

Figure 105 Thermo Fisher Cloud Connection Successful Message



You may tap the “OK” button or the X icon in the top right corner to close this window and return to the “Connectivity” screen.

When unsuccessful, an error message appears on the screen of the device, detailing the nature of the problem. Use this information for troubleshooting the connection problem, then try again.

Connect via Passcode

This procedure uses a passcode that is generated by the system when you open the “Connect via Passcode” screen shown in Figure 106.

Proceed as follows to connect using a passcode:

1. Create a Thermo Fisher Scientific account,
2. Tap the “Settings” icon  on the Main Navigation Bar.
3. Tap the “Connectivity” button  on the “Settings” screen.

The “Connectivity” screen shown in Figure 97 further above appears.

4. Tap the “Thermo Fisher Cloud” button.
5. Tap the “Connect via Passcode” box on the “Thermo Fisher Cloud” screen.

The system generates a passcode and displays it on the “Connect via Passcode” screen shown in Figure 106:

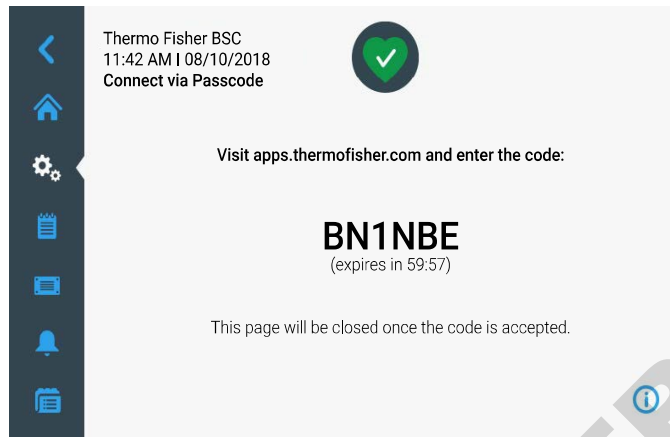
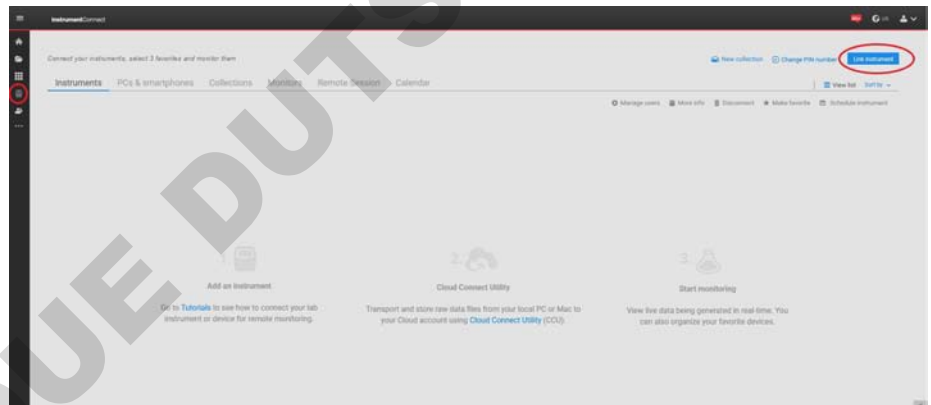

Figure 106 “Connect via Passcode” Screen

A unique code is generated by the system and displayed on the screen with additional text detailing the steps required by you to successfully connect the unit to the cloud. Follow the instructions on the website apps.thermofisher.com. When successful, the confirmation message shown in Figure 105 appears on the screen of the device.



1. Enter the 6-digit code.

When unsuccessful, an error message appears on the screen of the device, detailing the nature of the problem. Use this information for troubleshooting the connection problem, then try again.

Managing Thermo Fisher Cloud Access

At this time, there is no method to view/edit a list of linked Thermo Fisher Cloud accounts from the unit itself. Viewing, editing, and deleting accounts linked to the unit is done from the respective Thermo Fisher Cloud accounts using a web browser.

Displaying WiFi and Cloud Connectivity

Connecting the device via one of the three methods (via mobile device, passcode, username) is only possible, if the device has successfully established a connection to the cloud. This is indicated by the cloud icon that appears in the top left corner of the main screen. This icon indicates an existing connection to the cloud. It does not indicate that the device is already logged into the cloud, though.

If the unit is actively connected to a WiFi network and/or the Thermo Fisher Cloud, the corresponding icons are displayed in the top left corner of the main screen:



WiFi Connection Error

In the event of a defective WiFi connection, e.g. if the connection to the DHCP server cannot be established, the following menu is displayed with an „exclamation mark“ in the WiFi symbol:





Figure 107 „WiFi Connection Error“ Screen

Problem-solving measures:

1. Check DHCP server and restart if necessary
2. Restart the safety cabinet

Firmware Update

From time to time you will be informed about new software updates. Proceed as follows to update the firmware of your device:

1. Save two files to a USB memory stick:
 - a. the update file -*.update
 - b. the signature file - *.sign
2. Insert the USB memory stick into the USB port of your device.
3. Tap the “Settings” icon  on the Main Navigation Bar.
4. Tap the “Firmware” button  on the “Settings” screen.

Follow the instructions on the screen and wait for the update to be completed.

Access Control

Tapping the “Access Control” button  in the “Settings” screen takes you to the “Login” screen shown in Figure 42. After entering the passcode the “Access Control” screen Figure 108 is shown. The “Access Control” screen allows you to activate “Secure” mode, in which a passcode will be requested from all users who want to change its settings.

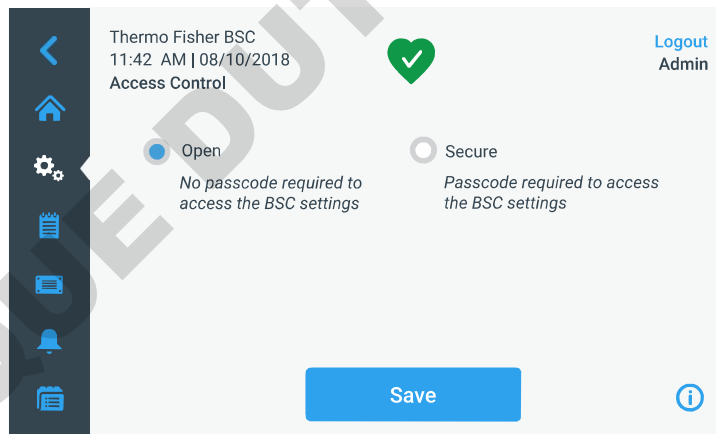

Figure 108 “Access Control” Screen in “Open” Mode

By default, the biological safety cabinet is in “Open” mode, that is, you do not need to enter a passcode to access and operate the unit.

NOTE The Admin passcode is 0418. The “Factory Settings” and “Field Certification” screens require specific passcodes, which are different from the Admin passcode. These screens are reserved for Thermo Scientific field service.

With a new login the mode can be changed again. Changing the access mode from “Open” to “Secure” requires the Admin passcode.

After the mode has been changed from “Open” to “Secure” by tapping the “Secure” radio button, the “Save” button turns blue to indicate that you may save your changes now.

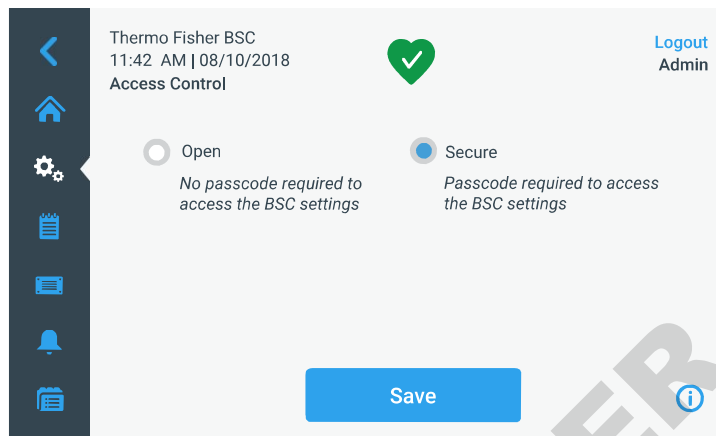



Figure 109 “Access Control” Screen in “Secure” Mode

You will be returned to the “Access Control” screen. The “Access Control” screen now has a “Logout” command and user name readout in the upper right corner.

Factory Settings

Tapping the “Factory Settings” button  in the “Settings” screen takes you to the “Factory Settings” screen. Access to the “Factory Settings” screen is reserved to Thermo Scientific Field Service and requires a special passcode (which differs from the Admin passcode).

Field Certification

Tapping the “Field Certification” button  in the “Settings” screen takes you to the field certification screen. Access to the “Field Certification” screen is reserved to Thermo Scientific Field Service and requires a special passcode (which differs from the Admin passcode).

Event Log

Tapping the “Event Log”  icon in the “Settings” screen takes you to the “Event Log” screen shown in Figure 110. The “Event Log” screen displays a complete and continuous list of events and alarms from the last 24 hours. For events > 24 hours the data log must be downloaded to a USB stick.

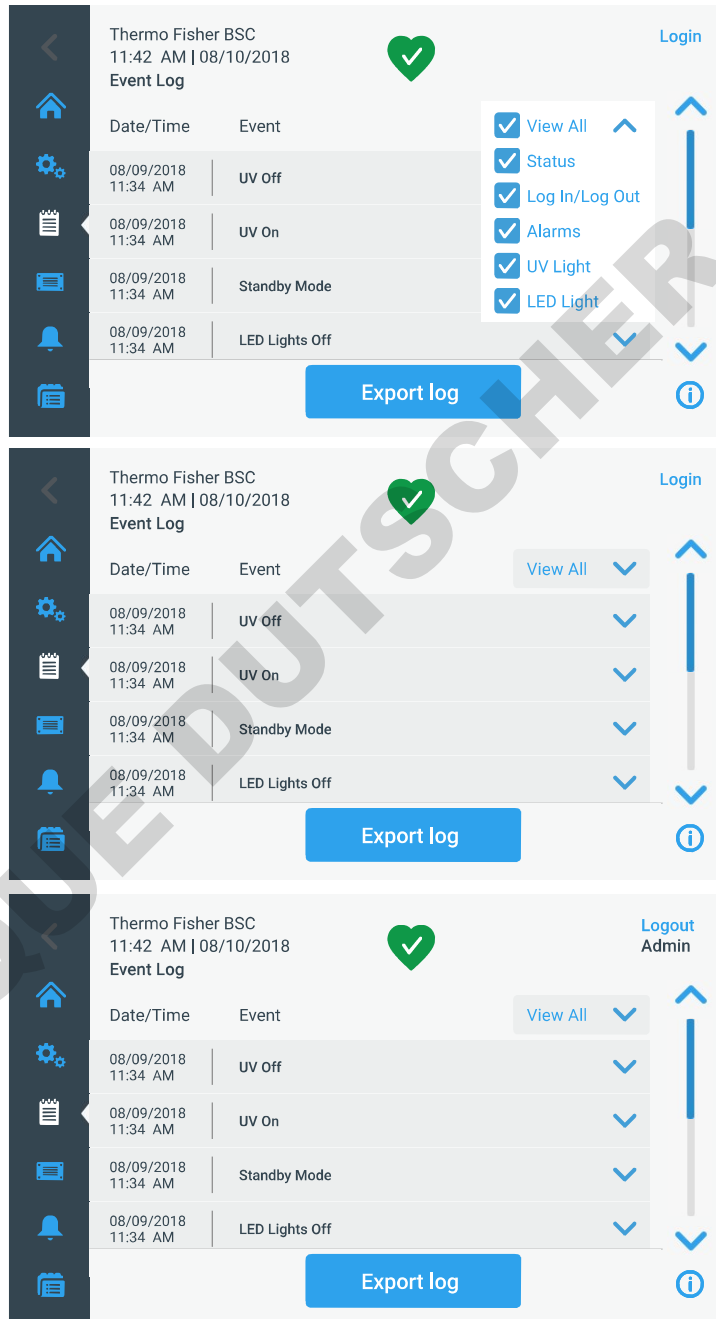

Figure 110 “Event Log” Screen

The “Event Log” screen displays the following information:

- Periodic status, as captured in 1 minute increments by default.
- Events, including alarms and alerts as well as changes to settings:

- For each alarm the time activated and the time deactivated is recorded. Alarms include:
 - inflow alarm low
 - inflow alarm high
 - downflow alarm low
 - downflow alarm high
 - window too low
 - window too high
 - external exhaust alarm, if applicable
- For each alert, the time activated is recorded. Alerts include:
 - 5% filter life remaining
 - 5% UV light life remaining
 - GFI tripped (US versions only)
 - annual field certification due
- Changes to settings include:
 - changes to the language, date, or time
 - changes to login/logout and/or associated passcode
 - reset of UV bulb, filters, or field certification timers
- Status of fans (on, off, reduced mode)
- Status of sample chamber illumination (on/off)
- Status of UV (on/disinfection cycle/off)
- Status of internal receptacle (on/off)
- Status of GFI (tripped/not tripped), if applicable

Viewing the Event Log

Proceed as follows to view the event log:

1. Tap the “Event Log” icon  on the Main Navigation Bar.

The “Event Log” screen shown in Figure 111 appears.

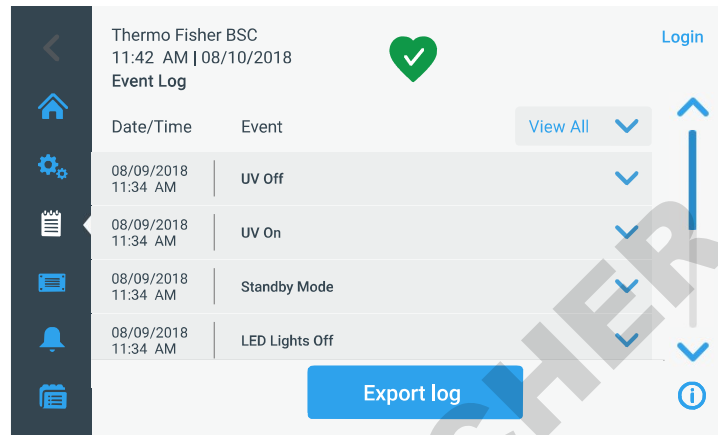

Figure 111 “Event Log” Screen: Standby Mode expanded

2. Tap the up and down arrows to the right of the event list to scroll.
3. Tap on any list item in the event log to expand it and view more detailed information, as shown for the Standby mode item in Figure 111.

Filtering the Event Log

The dropdown menu labeled “View All” on top of the event list allows the user to customize the content displayed in the “Event Log”. By default, the dropdown list is pre-set to “View All”, that is, the event list is unfiltered and shows the full content of the event log. You can expand the dropdown list and exclude or include whole classes of events to make the event list easier to read.

Proceed as follows to filter the event list:

1. Tap the dropdown menu labeled “View All” in the “Event Log” screen.

The dropdown list is expanded, displaying the filtering options shown in Figure 112.

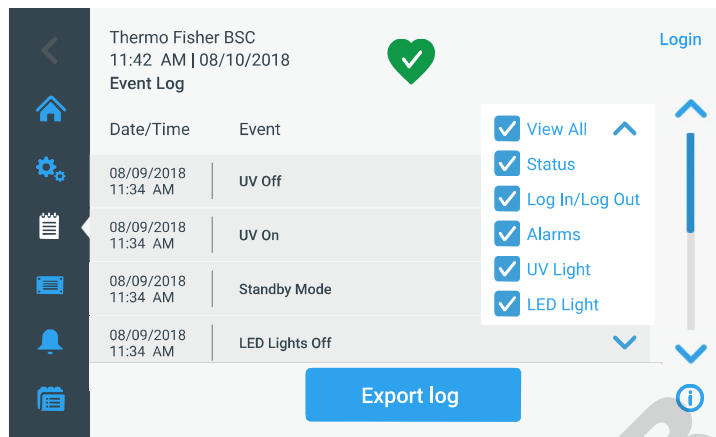

Figure 112 Filtering the “Event Log”

2. Uncheck the classes of events you wish to exclude from the event list.

The list in the event log is refreshed, displaying only the items you have left checked. The “View All” option is unchecked.

3. To undo filtering, check “View All”.

All options are checked again, and the full event list display is restored.

NOTE Unchecking options for onscreen viewing is only for the current session. If you navigate away from the event log screen and then return, you will find View All highlighted again.

Exporting the Event Log

The Event Log can be exported in Comma Separated Values (CSV) format, writing up to six months of event data. You must insert a USB drive to download the file to the USB port of the unit.

Various internal log files are exported along with the event data. Before exporting the event log, the following dialog is displayed:

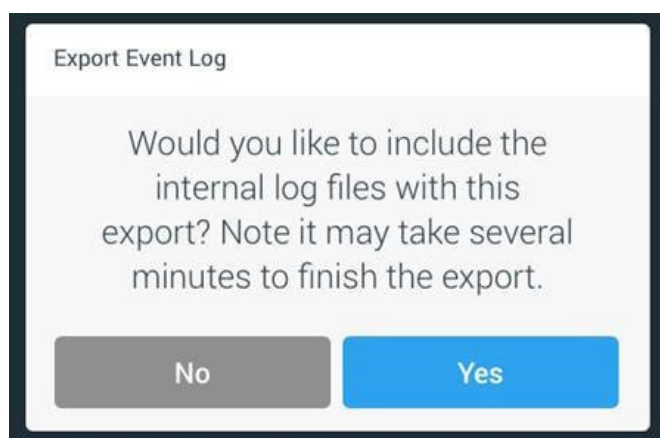

Proceed as follows to export the event log:

1. Insert a USB drive into the USB port, which is located in a small bay next to the display window.
2. Tap the “Export Log” button in the “Event Log” screen.
3. If you have not inserted a USB drive yet, the pop-up window shown in Figure 113 appears, asking you to insert a USB drive to export the log to. The window will close automatically when you insert a valid USB drive, and the export process will start.

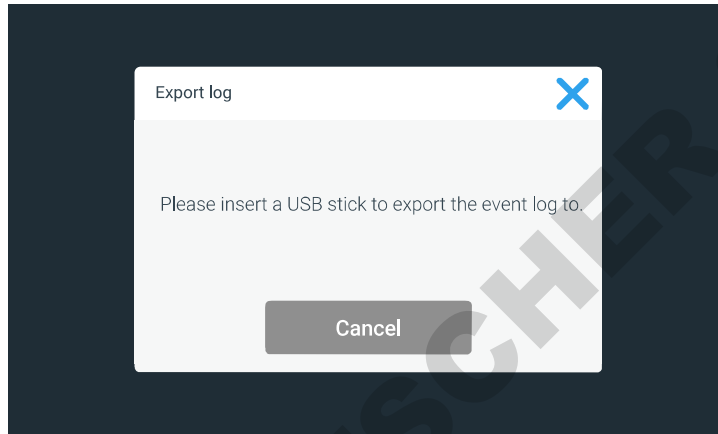

Figure 113 “Export log” Screen: Missing USB Drive Alert

- a. If you have inserted a USB drive that is not writable or readable, the pop-up window shown in Figure 114 appears, stating the drive is not readable and asking you to insert a different USB drive.

If you have inserted a valid USB drive, the export will start immediately. The pop-up window shown in Figure 114 appears, cautioning you not to remove the USB drive until the transfer is complete.

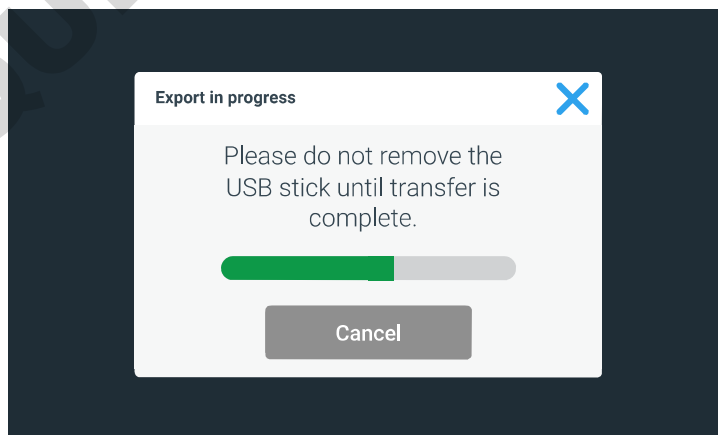

Figure 114 “Export in progress” Screen

4. If you wish to exit, you may tap the “Cancel” button or the “X” icon to close this window and return to the event log.

- When the export process has been completed, the final pop-up window shown in Figure 115 appears, announcing that you may remove the USB drive now.

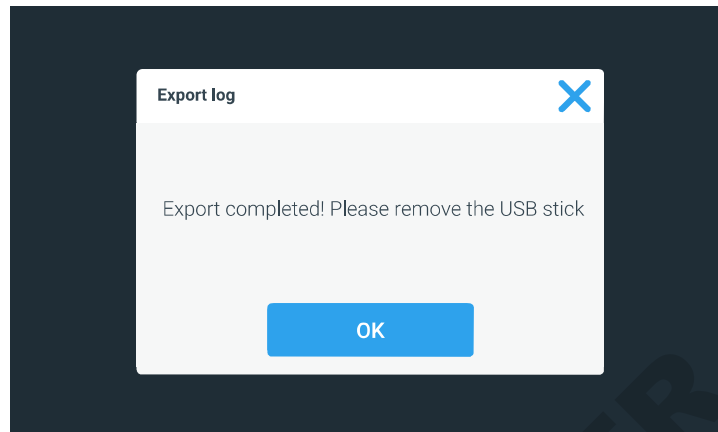

Figure 115 "Export log" Screen: Export completed

DOMINIQUE DUTSCHER SAS

Preparation

Hygiene Preparations for the Sample Chamber

The sample chamber surfaces and the accessories required for the work process must be disinfected and cleaned in accordance with the hygiene guidelines set forth for the application.

Preparing the Sample Chamber

Installing the accessories:

1. Lower the front window completely.
2. Open the front cover or move the front window into the maximum opening position.
3. Position the accessories in the working area of the workplate.
4. Close the front cover.
5. Move the front window to its working position and wait until the airflow has stabilized.



Operational safety!

The personal and material protection is ensured only if the airflow system of the device is working properly. If the alarm system issues failure messages when the front window is in the working position, stop all applications that may release harmful aerosols!

NOTE Cytostatics applications

Use only the low-profile, one-piece workplate for cytostatics applications.

6. Then place samples into the chamber.
7. To interrupt the work process or for extensive experiment cycles without manual interference, switch the device to standby mode. When the working opening is completely closed, the safety cabinet is sealed aerosol-tight.

Response to Failure Messages

Failure messages are displayed on the touchscreen display as outlined in the sections “Alarms” on page 65 and “Alerts” on page 68 . If one of these messages is displayed, contact the Technical Service immediately.

To isolate the cause of the failure, the operating personnel must perform only the following tests and measures:

- Check to see if the exhaust air opening on top of the cabinet is blocked.
- Ensure that the on-site exhaust air system is activated.
- Close doors and windows in the laboratory to prevent drafts.
- Switch off devices in the vicinity of the safety cabinet that cause air turbulence or emit excessive heat.
- Open flames in the sample chamber may impair airflow conditions.
- Restart the cabinet to check if failure messages persist.

Work Rules

The observance of work rules ensures a minimum of operational safety when handling the safety cabinet.

Before starting an operation:

- Take off jewelry.
- Put on required personal protective gear, e.g. hand, face, or body protection.
- Clean and disinfect sample chamber surfaces at regular intervals.

During an operation:

- Place samples only within the defined work area of the workplate.
- Do not place unnecessary items into the sample chamber.
- Use only disinfected and cleaned accessories for the work process.
- Do not cause air turbulence, by quick hand, arm or body movement in the sample chamber or in front of the work opening.
- Do not place accessories into the sample chamber that cause air turbulence or emit excessive heat.
- Do not block air circulation at the ventilation slots of the workplate.

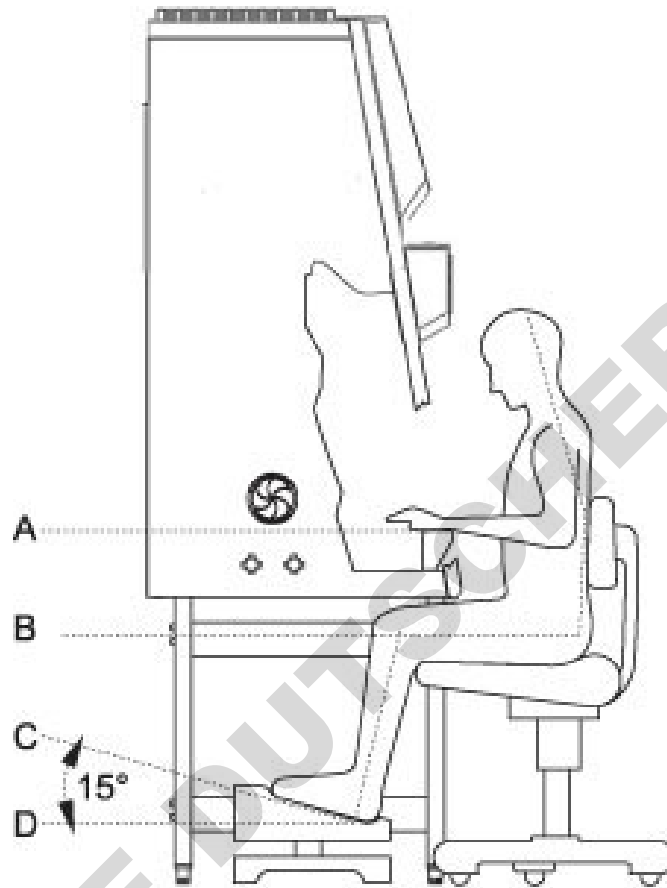
Sitting posture during work:**Figure 116** Sitting Posture

To prevent risks to health, a height-adjustable working chair with an adjustable seat back should be used during extended work periods at the safety cabinet.

- A** When the forearm rests on the armrest, it should be in an almost horizontal position.
- B** When the thigh is in a horizontal position, the angle between thigh and lower leg should exceed 90°.

To ensure a compensation between floor and sitting height, a footrest (DIN 4556) should be used. The minimal effective surface of the footrest should be 45 x 35 cm.

- C** The slope should be adjustable within a range of 5° to 15°.
- D** The adjustable height should extend to a minimum of 11 cm above the floor.

After finishing an operation:

- Remove samples from the sample chamber and store them properly.
- Clean and disinfect the sample chamber surfaces, including the workplate and the drain pan. Clean and disinfect all accessories.

DOMINIQUE DUTSCHER SAS

Shut-down

Interrupting an Operation

To interrupt a work process, the fans can be switched off.

1. Remove all samples from the safety cabinet and store them properly.
2. Remove accessories from the sample chamber and clean and disinfect them.
3. Clean and disinfect the sample chamber surfaces, the workplate, and the drain pan.
4. Switch the fans off.

Shutting the Unit down

If the unit is not to be used or stored for an extended period of time, it must be completely decontaminated.



Decontamination measures!

To shut the device down, the sample chamber must be disinfected completely and the plenum, including the filters, must be sterilized using formaldehyde.

1. After the device has been decontaminated, close the front window completely.
2. Disconnect the device from the power supply system.

DOMINIQUE DUTSCHER SAS

Cleaning and Decontamination



Before cleaning and UV disinfection the covers of the UV lamps must be removed and afterwards installed.

Decontamination Procedure

Several procedures can be applied for decontaminating the safety cabinet. Which procedure is selected, depends on:

- the potential risk imminent in the agents,
- the degree of purity required by an experiment or by a work process.

Possible decontamination procedures:

Wipe/spray disinfection: is the standard disinfection procedure for cabinets used for microbiological experiments.

UV disinfection: is particularly suited as an intensifying additional disinfection after a wipe/spray disinfection.

Sterilization with steam: can be used for treating the removable stainless steel components. Examples of autoclavable components are the bezels of the UV lamps, the workplate or workplate segments and the armrests.

Disinfection with formaldehyde: can be performed if a sterile sample chamber is required for the work process. This sterilization procedure is mandatory:

- when filters are replaced,
- when the device is shut down,
- when the device is discarded.

Wipe/Spray Disinfection

The wipe/spray disinfection is performed in three stages:

- pre-disinfection,
- cleaning,
- final disinfection.

Recommended disinfectants:**Compatibility**

Chloride-containing disinfectants may damage some surfaces; use only chloride-free disinfectants or a disinfectant with a low enough chloride content to have been proved harmless for stainless steel finishes! Disinfectants with an alcohol content of more than 70 % may cause embrittlement of plastic components after extended exposure. Use only disinfectants with a low alcohol content. When using a disinfectant with an alcohol content of more than 70 %, the release limit of 200 g within 2 hours must not be exceeded. Also suited are disinfectants based on quaternary ammonium compounds.

Predisinfection:

1. Remove all samples from the sample chamber and store them properly.
2. Remove accessories from the safety cabinet and disinfect them using the disinfection procedure recommended by the manufacturer.
3. The workplate and stainless steel components can be removed from the sample chamber and disinfected separately.
4. For predisinfection, spray disinfectant on all sample chamber surfaces or wipe the surfaces using disinfectant.
5. Do not remove the optional UV lamps from the sockets; wipe them thoroughly using a damp cloth.
6. Switch the device to work mode, move front window to the working position.
7. Allow disinfectant to react as recommended by manufacturer, then operate the safety cabinet for at least 15 to 20 minutes in the work mode so that released aerosols can be absorbed by the filters.

Cleaning:

1. Thoroughly remove dirt residues and deposits using a solution of tepid water and dishwashing agent.
2. Wipe the surfaces clean using a clean cloth and plenty of clear water.
3. Remove the cleaning liquid from the drain pan and wipe all sample chamber surfaces dry.

Final disinfection:

1. Again, spray disinfectant on all sample chamber surfaces or wipe the surfaces clean with disinfectant.
2. Allow disinfectant to react as recommended by manufacturer.

UV Disinfection after a Wipe/Spray Disinfection

A UV disinfection can be performed either by using the optional integral UV lamps or by using a mobile UV device. The run time of the routine can be preset with the operating panel.



Before disinfection remove the UV side covers and replace them afterwards. Do not apply too much cleaning agent to the UV emitter box. The ground fault circuit interrupter may release.

UV Disinfection using the integral UV Lamps

Running the UV disinfection routine, see “Running UV Disinfection” on page 59.

Changing the UV Disinfection Time

Setting the run time for the UV disinfection, see “Setting UV Disinfection Cycle Time” on page 74

Disinfection with Formaldehyde



Disinfection procedure

Disinfection with formaldehyde bears considerable risks, the procedure must only be performed by specially trained authorized service personnel and in accordance to national regulations.

A suitable disinfection procedure must be selected according to the scope of application of the safety cabinet.

One possible method based on EN 12469/2000 is described below.

To cover the spectrum of action A, B, C and D, it is necessary to use another method. Based on recommendations of the RKI (Robert Koch Institute), another disinfection procedure is described in the service manual.

Procedure in accordance to EN 12469 / 2000:

For gas disinfection, formaldehyde is evaporated in the sample chamber of the completely sealed cabinet. The quantity of the formaldehyde used depends on the sample chamber volume of the cabinet version to be disinfected (see “Technical Data” on page 137). Per cubic meter of sample chamber volume, at least 5 g formaldehyde must be evaporated with 20 ml water (corresponds with 25 ml of a 20 % formaldehyde solution). The formaldehyde evaporates immediately when its boiling point is reached. The required reaction time is at least 6 hours.

After the required reaction time, the formaldehyde should be neutralized by evaporating a 25 % ammonium solution (10 ml per cubic meter of sample chamber volume).

NOTE

After the neutralization reaction time with ammonia, carry out check measurements and ventilate. Ventilation until the MAK value is reached: Formaldehyde concentration <0.3 ppm (Occupational Exposure Limits).

Ambient conditions and accessories:

The temperature at the cabinet location should be approx 21 °C, the relative humidity should be between 60 and 85 %. To evaporate the solution, a heating device with a container is required.

Cleaning the exterior Surfaces

Wipe the exterior surfaces of the device clean using a solution of tepid water and commercial dishwasher solution. Then, wipe exterior surfaces dry using a soft, clean cloth.

Cleaning the Front Window

For cleaning the front window (and for disinfecting it using wipe disinfection), the front window can be closed and hinged.

Cleaning the Drain Pan

Clean the drain pan using a solution of tepid water and commercial dishwasher.

1. Remove the working plates from the workspace.
2. Remove dirt residues and deposits thoroughly.
3. Wipe the drain pan clean using a clean cloth and plenty of clear water.
4. Remove the cleaning liquid from the drain pan and wipe the drain pan surfaces thoroughly clean.



Material residues

After cleaning, make sure that all cleaning materials have been removed completely from the drain pan.

5. Reinstall the working plates.

Maintenance

Inspection

The annual inspection comprises the following checks:

- Electrical safety in accordance with national regulations.
- Functional test of the device.
- Checking all components for possible damage.
- Checking the filter state.

NOTE Perforated plate

The Perforated plate at the blanket of the sample chamber serves for the protection of the downflow filter and prevents refluxing. While scanning the filter surface for leak test the perforated plate must be built-in.

- Checking the airflow conditions.
- Repeat test in accordance with applicable standard (EN 12469:2000, NSF/ANSI 49 or other).

Service

HEPA filters:

As the filter replacement is an interference with the safety system of the device, filters must only be replaced by Thermo Electron LED or by adequately trained and authorized service personnel.

NOTE Filter change

Before filters are replaced the disinfection with formaldehyde is mandatory. After the filter replacement, a repeat test must be performed in accordance with applicable standard (EN 12469:2000, NSF/ANSI 49 or other).

UV Lamps



Before replacing the UV lamps disconnect the unit from the power supply.

The UV lamps should be replaced after 8000 operating hours:

1. Remove cover from lamp housing. The cover is only pushed onto the lamp casing and may be pulled off easily.
2. Rotate the lamp in the socket so that the lamp contacts can be removed from the groove in the socket.
3. Insert the new lamp into the socket and rotate until the contacts engage.
4. Push the cover onto the lamp casing.

Sample Chamber Illumination

The tubes are installed in the front cover bezel.

1. Remove the bezel retaining screws and the bezel.
2. The tubes are retained by rotatable sockets. Rotate the tube carefully to the removal position and remove it from the socket.
3. Insert the replacement tube and rotate it to the working position.
4. Reinstall the bezel and secure it with the screws.

Replacing the Front Cover Seal

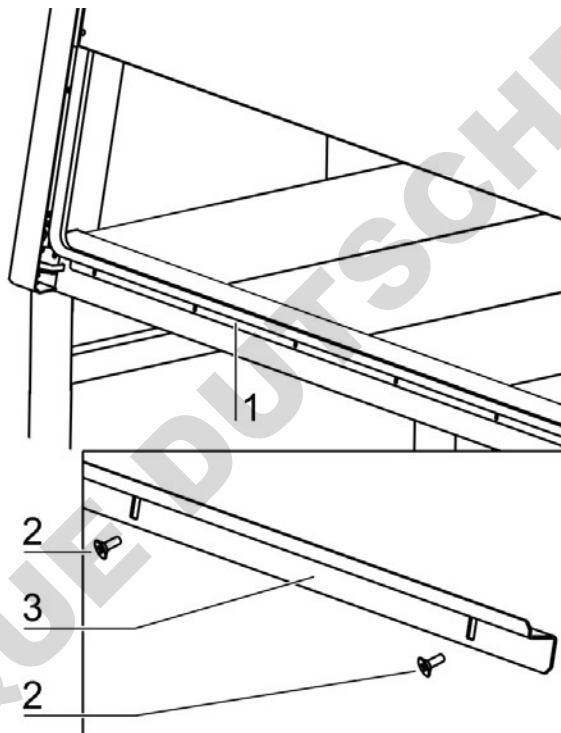

Figure 117 Replacing the Front Cover Seal

The seal is merely pushed onto the device frame and is secured additionally at the upper and lower side of the sample chamber opening by a retaining rail.

1. Remove the retaining screws [2] and remove the retaining rail [3].
2. Pull the seal [1] off the retaining lip at the device frame.
3. Push the groove of the replacement seal onto the retaining lip and press the seal on to ensure that it is positioned flush along the entire length of the contact surface.
4. Install the retaining rail.

NOTE

If the front door seal [1] shows visible signs of wear, the seal must be replaced by the service.

Exchanging SmartPorts



Contamination!

There is a risk of contamination for users and the product itself. In order to prevent contaminated particles escaping from the workspace, the unit must be switched on in order to exchange the SmartPorts.

The SmartPorts are removed inwards into the workspace. Prior to replacement, all work in the workspace must be finished.

1. Before replacing the SmartPorts, open the front window. Doing so will produce an alarm to indicate that there is a potentially unsafe operating condition.
2. Before replacing the SmartPorts, disinfect the workspace, front window, as well as the inner and outer compartment walls.
3. First remove the inner grommet of the SmartPort in the workspace inwards from the side panel opening.
4. Disinfect the grommet in the workspace and disinfect the inner compartment walls.
5. Insert new inner grommet in the side panel opening from the inside.
6. Then remove the outer grommet of the SmartPort in the workspace inwards from the side panel opening.
7. Place the removed grommet in the workspace and disinfect.
8. Disinfect the outer compartment walls.
9. Insert new outer grommet in the side panel opening from the outside.
10. Safely discard used disinfected grommets.

Retrofitting and Repairs

External communication systems, e.g. failure report systems or components for supplying media such as gas solenoid valves can be retrofitted and integrated into the device control.



Repairs

All retrofitting and repair work are interferences with the safety system of the unit. Particularly modifications to the filter system and resulting changes of the airflow may impair personal and material protection. Such work must be carried out only by authorized service personnel.

DOMINIQUE DUTSCHER SAS

Disposal

Disposal Procedure

Discarded cabinets or unit components contain reusable materials. All components with the exception of the HEPA filters can be disposed of after having been thoroughly decontaminated. The HEPA filters must be disposed of in accordance with the applicable national and state regulations for special solid waste.



Contamination hazard!

As the device can be used for processing and treating infectious substances, it may be contaminated. Prior to disposal, the complete device with filters must be decontaminated by performing a formaldehyde sterilization!



Recyclable materials!

Component	Material
Thermal insulation components	Polystyrene foam, EPS/PPS compound
Printed circuit boards	Enclosed electrical components coated with various plastics, mounted on epoxy resin-bound boards.
Plastic components, general	Note material labeling
Exterior housing	Steel, painted
Device backpanel	Stainless steel/steel, painted
Front cover seal	EMPP
Front window, side windows	Multi-layer safety glass
Operating panel and indicator foil	Polyethylene, Polyester
Workplates	Stainless steel
UV bezels	Stainless steel
Armrests	Stainless steel
Rechargeable battery (safety feature: Lower Front Window)	Nickel/metal hydrid

WEEE Conformity:

This product is required to comply with the European Union's Waste Electrical & Electronic Equipment (WEEE) Directive 2012/19/EU. It is marked with the following symbol:



Thermo Electron has contracted with one or more recycling/disposal companies in each EU Member State, and this product should be disposed of or recycled through them. Further information on Thermo Fisher Scientific's compliance with these Directives.

The recyclers in your country, and information on Thermo Scientific products which may assist the detection of substances subject to the RoHS Directive are available at www.thermofisher.com.

DOMINIQUE DUTSCHER SAS

Technical Data

Dimensions					
Herasafe 2030i / Maxisafe 2030i		0.9	1.2	1.5	1.8
Exterior dimensions					
Width	mm/in	1000/39.4	1300/51.2	1600/63.0	1900/74.8
Depth	mm/in	Herasafe 2030i 800/31.5 - Maxisafe 2030i 865/34.1			
Height	mm/in	1552/61.1			
Interior dimensions					
Width	mm/in	900/35.4	1200/47.2	1500/59.1	1800/70.9
Depth	mm/in	627/24.7			
Height	mm/in	780/30.7			
Front window					
Working position	mm/in	Herasafe 2030i 200/7.9 + 250/9.8 - Maxisafe 2030i 250/9.8			
Max. opening	mm/in	780/ 30.7			
Working area height					
Seat position	mm/in	750/29.5			
Heightable	mm/in	750/29.5 - 950/37.4			
Stand height					
	mm/in	680/26.8 - 880/34.6			
Unit height with stand					
	mm/in	2216/87 / max. 2416/95			
Side wall feed throughs					
Diameter	mm/in	21.3/0.84			
Distance lower edge	mm/in	135/5.3			
Distance from the rear wall					
Bushing 1	mm/in	153.5/6			
Bushing 2	mm/in	243.5/9.6			
SmartPort	mm/in	198.5/7.8			

Optional media connections in the interior - rear wall					
Herasafe 2030i / Maxisafe 2030i		0.9	1.2	1.5	1.8
Diameter	inch	R 3/8	R 3/8	R 3/8	R 3/8
Outer distance left					
Connection 1	mm/in	401/15.8	501/19.7	900.1/35.4	1050/41.3
Connection 2	mm/in	301/11.8	401/15.8	800.1/31.5	950/37.4
Connection 3	mm/in	201/7.9	301/11.8	700.1/27.6	850/33.5
Electrical Data					
Herasafe 2030i / Maxisafe 2030i		0.9	1.2	1.5	1.8
Voltage					
Rated voltage	V	230V - 1/N/PE AC - 50/60 Hz			
Fan voltage	V	48 V / DC			
Current					
Power consumption	A	7.0	7.0/7.5	9.0	9.0
Leakage current IEC 1010, EN 61010	mA	< 3.5			
Motherboard fusing	A	2 x T15A H			
Outlet fusing	A	2x T 5 A			
On-site fusing	A	Circuit breaker B 16 / Fuse T 16 A			
Equipment fusing (230V)	A	2 x T15A H			
Power					
Power input max.	W	1675	1675/1740	2010	2010
Protection					
Protection class		I			
Protection type		IP 20			
Overvoltage category (IEC 1010, EN 61010)		II			
Pollution degree (IEC 1010, EN 61010)		2			
Connection lines					
Connecting lines		cable (2.5 or 5 m/8.2 or 16.4 ft))			

Pressures					
Herasafe 2030i / Maxisafe 2030i		0.9	1.2	1.5	1.8
Pressure media valves	bar/psi	max. 6/87			
Volume, weights and loads					
Herasafe 2030i		0.9	1.2	1.5	1.8
Volume					
Device volume	m ³ /cf	1.1/39	1.4/49	1.7/60	2.1/74
Floorpan	l/cf	30/1	40/1.4	50/1.7	60/2.1
Weights					
Cabinet	kg/lbs	170/375	200/441	230/507	280/617
Stand AFS 1	kg/lbs	26/57	26/57	27/60	27/60
Stand AFS 2	kg/lbs	30/66	30/66	31/68	31/68
Loads					
Max. load per working area module	kg/lbs	25/55			
Max. load on overall working area	kg/lbs	50/110	75/165	75/165	75/165
Maxisafe 2030i		0.9	1.2	1.5	1.8
Volume					
Device volume	m ³ /cf	1.4/	1.7/60	2.1/74	2.7/
Floorpan	l/cf	4/0.14	5/0.18	6/0.21	7.5/0.26
Weights					
Cabinet	kg/lbs	200/441	240/529	280/617	330/728
Stand AFS 2	kg/lbs	30/66	30/66	31/68	31/68
Loads					
Max. load per working area module	kg/lbs	25/55			
Max. load on overall working area	kg/lbs	50/110	75/165	75/165	75/165

Airflow system					
Herasafe 2030i / Maxisafe 2030i		0.9	1.2	1.5	1.8
Air speeds					
Inflow	m/s	0.45/88.6			
Downflow	m/s	0.32/63			
Air volume					
200 mm/8" access opening		0.9	1.2	1.5	1.8
Overall volume flow	m ³ /h / cfm	910/536	1215/715	1520/894	1824/1074
Downflow volume flow	m ³ /h / cfm	622/366	829/488	1037/610	1244/732
Inflow air volume flow	m ³ /h / cfm	288/170	386/227	483/284	580/341
250 mm / 10" access opening (only for Herasafe 2030i)					
Overall volume flow	m ³ /h / cfm	983/578	1311/772	1640/965	1969/1159
Downflow volume flow	m ³ /h / cfm	622/366	829/488	1037/610	1244/732
Inflow air volume flow	m ³ /h / cfm	360/212	482/284	603/355	725/427

Filter					
Herasafe 2030i / Maxisafe 2030i		0.9	1.2	1.5	1.8
Type		HEPA (H 14 acc. DIN EN 1822)			
Material		Glass fiber fleece			
Separability in MPPS	%	99.995			
Separability at 0.3 µm particle size	%	99.999			
Downflow					
Width	mm/in	915/36	1220/48	1525/60	1830/72
Depth	mm/in	457/18			
Height	mm/in	93/3.7			
Exhaust					
Width	mm/in	457/18	610/24	915/36	
Depth	mm/in	457/18	457/18	457/18	
Height	mm/in	117/4.6	117/4.6	117/4.6	
Prefilter					
Maxisafe 2030i		0.9	1.2	1.5	1.8
Type		HEPA (H 14 acc. DIN EN 1822)			
Material		Glass fiber fleece			
Separability in MPPS	%	99.995			
Separability at 0.3 µm particle size	%	99.999			
Width	mm/in		865/34		
Depth	mm/in		257/10		
Height	mm/in		575/23		

Ambient conditions					
Herasafe 2030i / Maxisafe 2030i		0.9	1.2	1.5	1.8
Temperature					
Max. ambient temperature during operation	°C / °F	40/104			
Min. ambient temperature during operation	°C / °F	10/50			
Humidity					
Max. humidity/operation	% h.r.	90			
Max. humidity/storage	% h.r.	90			
Heat dissipation to environment					
200 mm/8" access opening					
Room temperature 20°C	kJ/s / BTU/hr	0.13/454	0.15/522	0.22/740	0.25/856
250 mm access opening					
Room temperature 20 °C	kJ/s / BTU/hr	0.16/529	0.18/597	0.24/819	0.3/1024
Room temperature rise					
Above room temperature with window closed	°K	< 2			
Ergonomics					
Noise level	dB(A)	57	57	57	57
		The noise level was determined in accordance with EN ISO 3744. The sound pressure level was measured at a distance of 1 m in front of the working opening. The measurement uncertainty is within a range of ± 2 dB.			

Herasafe 2030i / Maxisafe 2030i					
		0.9	1.2	1.5	1.8
Dongle					
Hardware interface		40			
Standard					
Frequency band					
Data rate					
Output power					
Security					
Max. humidity (operation)	% h.r.	90			
Max. humidity (storage)	% h.r.	90			
Pollution degree					

DOMINIQUE DUTSCHER SAS

DOMINIQUE DUTSCHER SAS

Device Log

Device type:		Part number:		
Serial number:		Service number:		
Location:		Operator's note:		
Work carried out		Notes	Date	Signature

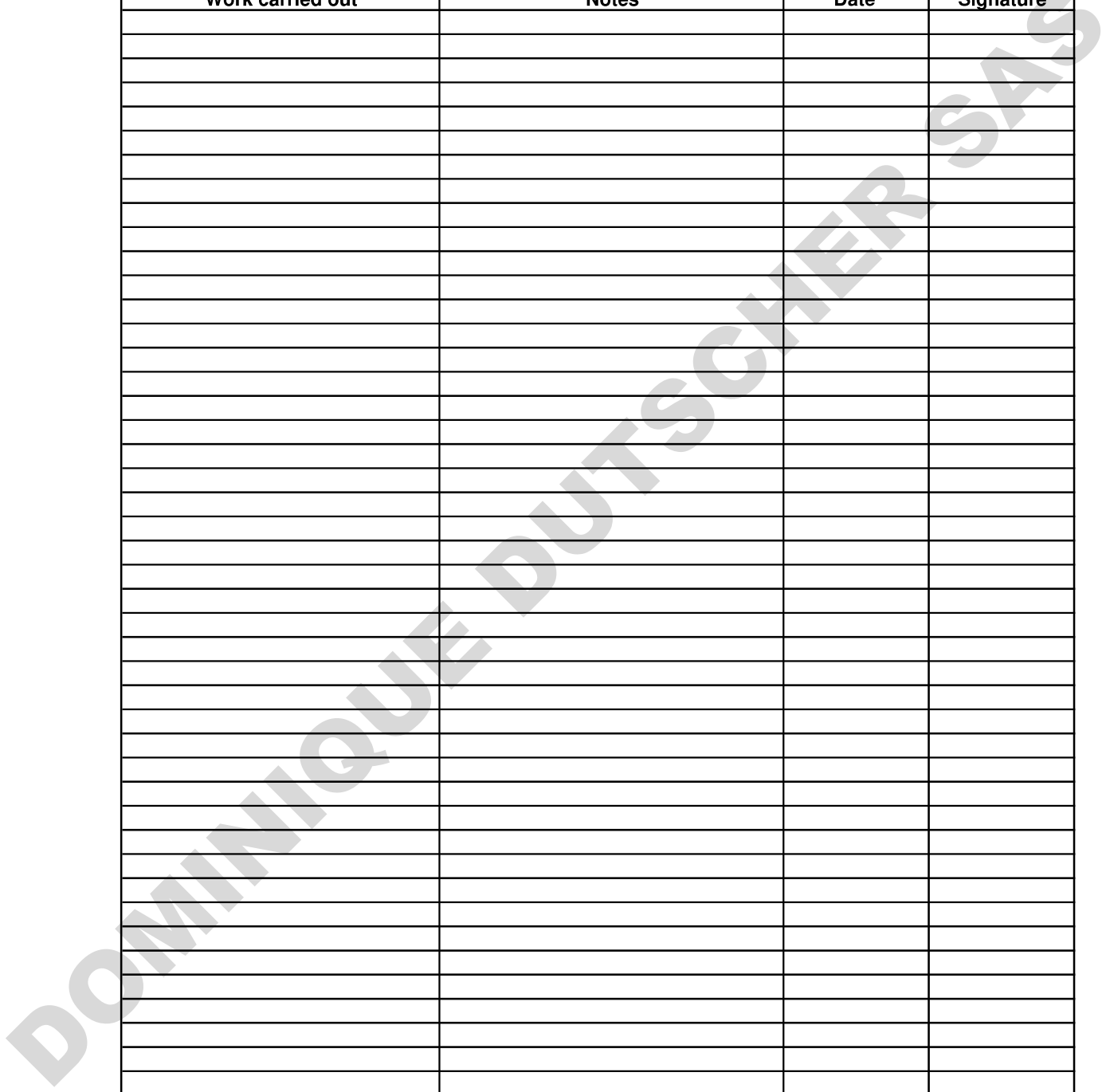

DOMINIQUE DUTSCHER SAS

Certificate of Decontamination

Invoice recipient / Customer no.:				Location / Forwarding address:			
Year of manufacturer:		KC:	ST:	Name of technician:		Appointed date:	
order date:		Ordered by:		Order no.:			
Type of device:				ID no. / Order no.:		Operating hours:	
Equipment no.:		Factory no.:		Service device no.:		Date of delivery:	
				Date of start-up:		Customer inventory no.:	
Certificate of decontamination							
<p>Dear customer,</p> <p>when using biological and chemical agents within and outside of devices, hazards to the health of the operating personnel may be present and contamination of the surroundings of the device may occur when service or repair works are carried out. Within the scope of national and international legal regulations, such as</p> <ul style="list-style-type: none"> - responsibility of a company for the protection of its employees, - responsibility of the operator for the operational safety of devices, <p>all possible hazards must absolutely be prevented. Prior to any calibration, service, and repair works, prior to any relocation of a device, and prior to the shut-down of a device, the device must be decontaminated, disinfected, and cleaned as required by the work to be carried out. Therefore, we ask you to fill in this certificate of decontamination before you start with the required work.</p> <p>Yours sincerely</p> <p>Thermo Electron LED GmbH</p>							
Works to be carried out (please mark where applicable)							
Service		<input type="checkbox"/>		Filter replacement		<input type="checkbox"/>	
Repair		<input type="checkbox"/>		Relocation		<input type="checkbox"/>	
Calibration		<input type="checkbox"/>		Transport		<input type="checkbox"/>	
Declaration of possible contamination (please mark where applicable)							
The device is clear of biological material				<input type="checkbox"/>		The device is clear of dangerous chemical substances	
The device is clear of radioactivity				<input type="checkbox"/>		The device is clear of other dangerous substances	
The device is clear of cytostatic agents				<input type="checkbox"/>			
Certification:							
<p>Prior to carrying out the required work, we have decontaminated, disinfected, and cleaned the device as described in the operating instructions of the device and in accordance with nationally applicable regulations. The device does not present any hazards.</p>							
Note:							
Date, legally binding signature, stamp							

DOMINIQUE DUTSCHER SAS

Appendix: City Time Zones

Time Zone, Offset to UTC	City
Africa / 00:00	Abidjan, Ivory Coast
	Accra, Ghana
	Algiers, Algeria
	Bamako, Mali
	Banjul, Gambia
	Casablanca, Morocco
	Conakry, Guinea
	Dakar, Senegal
	Lome, Togo
	Monrovia, Liberia
	Nouakchott, Mauritania
	Ouagadougou, Burkina Faso
	Sao Tome and Principe
	Sierra Leone
Africa / -01:00	Bissau, Guinea-Bissau
	El Aaiún, Western Sahara
Africa / +01:00	Bangui, Central African Republic
	Brazzaville, Congo (Republic)
	Douala, Cameroon
	Kinshasa, Congo (DRC)
	Lagos, Nigeria
	Libreville, Gabon
	Luanda, Angola
	Malabo, Equatorial Guinea
	N'Djamena, Chad
	Niamey, Niger
	Porto-Novo, Benin
Tunis, Tunisia	

Africa / +02:00

Blantyre, Malawi

Bujumbura, Burundi

Cairo, Egypt

Gaborone, Botswana

Harare, Zimbabwe

Johannesburg, South Africa

Juba, South Sudan

Khartoum, Sudan

Kigali, Rwanda

Lubumbashi, Congo (DRC)

Lusaka, Zambia

Maputo, Mozambique

Maseru, Lesotho

Mbabane, Swaziland

Tripoli, Libya

Windhoek, Namibia

Africa / +03:00

Addis Ababa, Ethiopia

Asmara, Eritrea

Dar es Salaam, Tanzania

Djibouti, Djibouti

Kampala, Uganda

Mogadishu, Somalia

Nairobi, Kenya

America / -02:00

Noronha, Brazil

Scoresbysund, Greenland

America / -02:30

St John's, Canada

America / -03:00

Araguaina, Brazil

Bahia, Brazil

Belem, Brazil

Buenos Aires, Argentina

Catamarca, Argentina

Cayenne, French Guiana

Cordoba, Argentina

Danmarkshavn, Greenland

Fortaleza, Brazil

Godthab, Greenland

Jujuy, Argentina

La Rioja, Argentina

Maceio, Brazil

Mendoza, Argentina

Montevideo, Uruguay

Paramaribo, Suriname

Punta Arenas, Chile

Recife, Brazil

Rio Gallegos, Argentina

Salta, Argentina

San Juan, Argentina

San Luis, Argentina

Santiago, Chile

Sao Paulo, Brazil

Tucuman, Argentina

Ushuaia, Argentina

America / -04:00

Anguilla, Anguilla

Antigua, Antigua & Barbuda

Aruba, Aruba

Asuncion, Paraguay

Barbados, Barbados

Blanc-Sablon, Canada

Boa Vista, Brazil

Campo Grande, Brazil

Caracas, Venezuela

Cuiaba, Brazil

Curacao, Curaçao

Dominica, Dominica

Glace Bay, Canada

Goose Bay, Canada

Grenada, Grenada

Guadeloupe, Guadeloupe

Guyana, Guyana

Halifax, Canada

Kralendijk, Caribbean Netherlands

La Paz, Bolivia

Lower Princes, Sint Maarten

Manaus, Brazil

Marigot, St. Martin

Martinique, Martinique

Miquelon, St. Pierre & Miquelon

Moncton, Canada

Montserrat, Montserrat

Pangnirtung, Canada

Port of Spain, Trinidad & Tobago

Porto Velho, Brazil

Puerto Rico, Puerto Rico

Santarem, Brazil

Santo Domingo, Dominican Republic

St Barthelemy, St. Barthélemy

St Kitts, St. Kitts & Nevis

St Lucia, St. Lucia

St Thomas, U.S. Virgin Islands

St Vincent, St. Vincent & Grenadines

Thule, Greenland

Tortola, British Virgin Islands

America / -05:00

Atikokan, Canada

Bogota, Colombia

Cayman, Cayman Islands

Detroit, US

Eirunepe, Brazil

Grand Turk, Turks & Caicos Islands

Guayaquil, Ecuador

Havana, Cuba

Indianapolis, US (Indiana)

Marengo, US (Indiana)

Tell City, US (Indiana)

Vevay, US (Indiana)

Vincennes, US (Indiana)

Winamac, US (Indiana)

Iqaluit, Canada

Jamaica, Jamaica

Louisville, US (Kentucky)

Lima, Peru

Menominee, US

Nassau, Bahamas

New York, US

Nipigon, Canada

Panama, Panama

Port-au-Prince, Haiti

Rio Branco, Brazil

Thunder Bay, Canada

Toronto, Canada

America / -06:00

Belize, Belize

Cancun, Mexico

Chicago, US

Chihuahua, Mexico

Costa Rica, Costa Rica

El Salvador, El Salvador

Guatemala, Guatemala

Knox, US (Indiana)

Petersburg, US (Indiana)

Monticello, US (Kentucky)

Managua, Nicaragua

Matamoros, Mexico

Merida, Mexico

Mexico City, Mexico

Monterrey, Mexico

Ojinaga, Mexico

Rainy River, Canada

Rankin Inlet, Canada

Regina, Canada

Resolute, Canada

Tegucigalpa, Honduras

Winnipeg, Canada

America / -07:00

Boise, US

Cambridge Bay, Canada

Creston, Canada

Denver, US

Edmonton, Canada

Beulah, US (North Dakota)

Center, US (North Dakota)

New Salem, US (North Dakota)

Phoenix, US

Swift Current, Canada

Yellowknife, Canada

America / -08:00	Bahia Banderas, Mexico
	Dawson Creek, Canada
	Fort Nelson, Canada
	Hermosillo, Mexico
	Inuvik, Canada
	Juneau, US
	Los Angeles, US
	Mazatlan, Mexico
	Metlakatla, US
	Sitka, US
	Tijuana, Mexico
	Vancouver, Canada
	Whitehorse, Canada
	America / -09:00
	Yakutat, US
America / -10:00	Anchorage, US
America / -11:00	Adak, US
	Nome, US
Antarctica / +03:00	Syowa, Antarctica
Antarctica / +06:00	Mawson, Antarctica
	Vostok, Antarctica
Antarctica / +07:00	Davis, Antarctica
Antarctica / +08:00	Casey, Antarctica
Antarctica / +10:00	Dumont Durville, Antarctica
Antarctica / +11:00	Macquarie, Australia
Antarctica / +12:00	McMurdo, Antarctica
Antarctica / 00:00	Rothera, Antarctica
	Troll, Antarctica
Antarctica / -3:00	Palmer, Antarctica
Arctic / +01:00	Longyearbyen, Svalbard & Jan Mayen

Asia / +02:00	Amman, Jordan
	Beirut, Lebanon
	Damascus, Syria
	Famagusta, Cyprus
	Gaza, Palestine
	Hebron, Palestine
	Jerusalem, Israel
	Nicosia, Cyprus
Asia / +03:00	Aden, Yemen
	Baghdad, Iraq
	Kuwait, Kuwait
	Riyadh, Saudi Arabia
Asia / +03:50	Tehran, Iran
Asia / +04:00	Bahrain, Bahrain
	Baku, Azerbaijan
	Dubai, United Arab Emirates
	Muscat, Oman
	Qatar, Qatar
	Tbilisi, Georgia
	Yerevan, Armenia
	Asia / +04:50
Asia / +05:00	Aqtau, Kazakhstan
	Aqtobe, Kazakhstan
	Ashgabat, Turkmenistan
	Atyrau, Kazakhstan
	Karachi, Pakistan
	Oral, Kazakhstan
	Qostanay, Kazakhstan
	Qyzylorda, Kazakhstan
	Samarkand, Uzbekistan
	Yekaterinburg, Russia
	Asia / +05:50
Kathmandu, Nepal	
Kolkata, India	
Thimphu, Bhutan	

Asia / +06:00

Almaty, Kazakhstan

Bishkek, Kyrgyzstan

Dhaka, Bangladesh

Dushanbe, Tajikistan

Hovd, Mongolia

Omsk, Russia

Tashkent, Uzbekistan

Urumqi, China

Asia / +06:50

Yangon, Myanmar

Asia / +07:00

Bangkok, Thailand

Barnaul, Russia

Choibalsan, Mongolia

Jakarta, Indonesia

Krasnoyarsk, Russia

Novokuznetsk, Russia

Novosibirsk, Russia

Phnom Penh, Cambodia

Tomsk, Russia

Ulaanbaatar, Mongolia

Vientiane, Laos

Asia / +07:50

Kuala Lumpur, Malaysia

Singapore, Singapore

Asia / +08:00

Brunei, Brunei

Ho Chi Minh, Vietnam

Hong Kong, Hong Kong

Irkutsk, Russia

Kuching, Malaysia

Macao, Macao

Makassar, Indonesia

Manila, Philippines

Pontianak, Indonesia

Shanghai, China

Taipei, Taiwan

Asia / +09:00	Chita, Russia
	Dili, East Timor
	Jayapura, Indonesia
	Khandyga, Russia
	Pyongyang, North Korea
	Seoul, South Korea
	Tokyo, Japan
	Ust-Nera, Russia
	Yakutsk, Russia
Asia / +10:00	Vladivostok, Russia
Asia / +11:00	Magadan, Russia
	Sakhalin, Russia
	Srednekolymsk, Russia
Asia / +12:00	Kamchatka, Russia
Asia / +13:00	Anadyr, Russia
Atlantic / 00:00	Canary, Spain
	Faroe, Faroe Islands
	Madeira, Portugal
	Reykjavik, Iceland
	St Helena, St. Helena
	Atlantic / -1:00
Atlantic / -2:00	Cape Verde, Cape Verde
	South Georgia, South Georgia & South Sandwich Islands
Atlantic / -4:00	Bermuda, Bermuda
	Stanley, Falkland Islands (Islas Malvinas)
Australia / +08:00	Perth, Australia
Australia / +09:50	Adelaide, Australia
	Broken Hill, Australia
	Darwin, Australia
Australia / +08:45	Eucla, Australia

Australia / +10:00	Brisbane, Australia
	Currie, Australia
	Lindeman, Australia
	Lord Howe, Australia
	Melbourne, Australia
	Sydney, Australia
Australia / +11:00	Hobart, Australia
Europe / 00:00	Ceuta, Spain
Europe / +01:00	Amsterdam, Netherlands
	Andorra, Andorra
	Belgrade, Serbia
	Berlin, Germany
	Bratislava, Slovakia
	Brussels, Belgium
	Budapest, Hungary
	Busingen, Germany
	Copenhagen, Denmark
	Dublin, Ireland
	Gibraltar, Gibraltar
	Guernsey, Guernsey
	Isle of Man, Isle of Man
	Jersey, Jersey
	Lisbon, Portugal
	Ljubljana, Slovenia
	London, UK
	Luxembourg, Luxembourg
	Madrid, Spain
	Malta, Malta
	Monaco, Monaco
	Oslo, Norway
	Paris, France
	Podgorica, Montenegro
	Prague, Czech Republic
	Rome, Italy
	San Marino, San Marino
	Sarajevo, Bosnia

	Skopje, North Macedonia
	Stockholm, Sweden
	Tirane, Albania
	Vaduz, Liechtenstein
	Vatican, Vatican City
	Vienna, Austria
	Warsaw, Poland
	Zagreb, Croatia
	Zurich, Switzerland
Europe / +02:00	Athens, Greece
	Bucharest, Romania
	Helsinki, Finland
	Istanbul, Turkey
	Mariehamn, Åland Islands
	Sofia, Bulgaria
Europe / +03:00	Chisinau, Moldova
	Kaliningrad, Russia
	Kiev, Ukraine
	Minsk, Belarus
	Moscow, Russia
	Riga, Latvia
	Simferopol, Ukraine
	Tallinn, Estonia
	Uzhgorod, Ukraine
	Vilnius, Lithuania
	Zaporozhye, Ukraine
Europe / +04:00	Astrakhan, Russia
	Kirov, Russia
	Samara, Russia
	Saratov, Russia
	Ulyanovsk, Russia
	Volgograd, Russia
Indian / +03:00	Antananarivo, Madagascar
	Comoro, Comoros
	Mayotte, Mayotte
Indian / +04:00	Mahu, Seychelles

	Mauritius, Mauritius
	Réunion, Réunion
Indian / +05:00	Chagos, British Indian Ocean Territory
	Kerguelen, French Southern Territories
	Maldives, Maldives
Indian / +06:50	Cocos, Cocos (Keeling) Islands
Indian / +07:00	Christmas, Christmas Island
Pacific / -5:00	Galapagos, Ecuador
Pacific / -6:00	Easter, Chile
Pacific / -08:00	Pitcairn, Pitcairn Islands
Pacific / -9:00	Gambier, French Polynesia
Pacific / -09:30	Marquesas, French Polynesia
Pacific / -10:00	Honolulu, US
	Rarotonga, Cook Islands
	Tahiti, French Polynesia
Pacific / -11:00	Apia, Samoa
	Fakaofu, Tokelau
	Midway, U.S. Outlying Islands
	Niue, Niue
	Pago Pago, American Samoa
Pacific / -12:00	Enderbury, Kiribati
	Kwajalein, Marshall Islands
Pacific / +09:00	Palau, Palau
Pacific / +10:00	Bougainville, Papua New Guinea
	Chuuk, Micronesia
	Guam, Guam
	Port Moresby, Papua New Guinea
	Saipan, Northern Mariana Islands
Pacific / +11:00	Efate, Vanuatu
	Guadalcanal, Solomon Islands
	Noumea, New Caledonia
	Pohnpei, Micronesia
Pacific / +11:50	Nauru, Nauru
	Norfolk, Norfolk Island
Pacific / +12:00	Auckland, New Zealand
	Fiji, Fiji

	Funafuti, Tuvalu
	Kosrae, Micronesia
	Majuro, Marshall Islands
	Tarawa, Kiribati
	Wake, U.S. Outlying Islands
	Wallis, Wallis & Futuna
Pacific / +12:45	Chatham, New Zealand
Pacific / +13:00	Tongatapu, Tonga
Pacific / +14:00	Kiritimati, Kiribati

DOMINIQUE DUTSCHER SAS

DOMINIQUE DUTSCHER SAS

Find out more at [thermofisher.com](https://www.thermofisher.com)

thermoscientific