

**Heratherm Refrigerated Incubators  
IMP 180 / IMP 400**

50150875 Revision 00 July 2016

**thermo**scientific

© 2016 Thermo Fisher Scientific Inc. All rights reserved.

Thermo Fisher Scientific Inc. provides this document to its customers with a product purchase to use in the product operation. This document is copyright protected and any reproduction of the whole or any part of this document is strictly prohibited, except with the written authorization of Thermo Fisher Scientific Inc.

The contents of this document are subject to change without notice.

All technical information in this document is for reference purposes only. System configurations and specifications in this document supersede all previous information received by the purchaser.

**Thermo Fisher Scientific Inc. makes no representations that this document is complete, accurate or error-free and assumes no responsibility and will not be liable for any errors, omissions, damage or loss that might result from any use of this document, even if the information in the document is followed properly.**

This document is not part of any sales contract between Thermo Fisher Scientific Inc. and a purchaser. This document shall in no way govern or modify any Terms and Conditions

In case of conflicting translations into foreign languages the German-language version of these operating instructions shall be binding.

#### **Trademarks**

Heratherm™ is a registered trademark of Thermo Scientific.

Thermo Scientific is a brand owned by Thermo Fisher Scientific, Inc.

All other trademarks mentioned in the operating instructions are the exclusive property of the respective manufacturers.

Thermo Fisher Scientific  
Robert-Bosch-Straße 1  
D - 63505 Langenselbold  
Germany

Thermo Electron LED GmbH is an affiliate to:  
Thermo Fisher Scientific Inc.  
81 Wyman Street  
Waltham, MA 02454  
USA

# Contents

<b>Chapter 1 Safety Notes .....</b>	<b>1-1</b>
Basic Operating Precautions .....	1-1
Operational Safety Rules .....	1-2
Warranty .....	1-2
Explanation of Safety Information and Symbols .....	1-3
Safety Notes and Symbols Used Throughout These Operating Instructions .....	1-3
Additional Symbols for Safety Information .....	1-4
Symbols on the refrigerated incubator .....	1-5
Intended Purpose of the refrigerated incubator .....	1-6
Intended Purpose of the refrigerated incubator .....	1-6
Incorrect Use .....	1-6
Standards and Directives .....	1-6
<b>Chapter 2 Delivery of the refrigerated incubator.....</b>	<b>2-1</b>
Packaging .....	2-1
Acceptance Inspection .....	2-1
Scope of Supply .....	2-2
<b>Chapter 3 Installation .....</b>	<b>3-1</b>
Ambient Conditions.....	3-1
Location Requirements.....	3-1
Intermediate Storage.....	3-2
Room Ventilation.....	3-2
Space Requirement .....	3-3
Table-top refrigerated incubators .....	3-3
Floor Stand refrigerated incubators .....	3-4
Transport .....	3-5
Stacking Table-Top Units .....	3-7
Installing the Anti-tilt Anchor .....	3-8
<b>Chapter 4 Product Description .....</b>	<b>4-1</b>
Heratherm IMP Series refrigerated incubator Overview.....	4-1
Door frame heater .....	4-1
Over-temperature protection (TWB).....	4-1
Peltier System .....	4-6
Safety Devices.....	4-7
Work Space Atmosphere .....	4-7
Door Switch (Option) .....	4-7
Sensing and Control System .....	4-7
Data Communications & Alarm Interface.....	4-9
RS-232 Interface.....	4-9

Alarm Contact.....	4-9
AC Power Socket.....	4-9
Fuses.....	4-9
Work Space Components.....	4-11
Inner Chamber.....	4-11
Access Port (Option).....	4-11
Shelf System.....	4-12
Additional Tube Access Port (Option).....	4-13
<b>Chapter 5 Installation procedures.....</b>	<b>5-1</b>
Table-top refrigerated incubators.....	5-1
Installing the Shelf System.....	5-1
Initial Installation.....	5-1
Installing the Perforated Shelves.....	5-2
Preparing the useable space.....	5-2
Installation or Removal of the Support Rails.....	5-3
Installing and Uninstalling the Air Baffle.....	5-4
Levelling the refrigerated incubator.....	5-4
Commissioning of floor stand refrigerated incubators.....	5-5
Installing/Removing air baffles (IMP-S Series).....	5-5
Commissioning, general.....	5-6
Installing the Shelf Support Brackets.....	5-6
Installing the Perforated Shelves.....	5-6
Mains connection.....	5-7
Connecting to the Power Supply Source.....	5-7
Connecting the RS-232 Interface.....	5-8
Interconnecting the refrigerated incubator with a Computer.....	5-9
Wiring the Alarm Contact.....	5-11
Functional Description.....	5-11
Alarm Relay Specifications.....	5-11
Connection Example.....	5-12
<b>Chapter 6 Operation.....</b>	<b>6-1</b>
Preparing the refrigerated incubator.....	6-1
Starting Operation.....	6-1
<b>Chapter 7 Handling and Control.....</b>	<b>7-1</b>
Powering Up.....	7-4
Switching the refrigerated incubator Off / Powering Down.....	7-5
Temperature Set Value.....	7-5
Timer.....	7-6
Setting a Fixed-time On or Off Timer.....	7-8
Setting a Weekly Timer.....	7-9
Stopping a Timer.....	7-11
Power Outlet (optional).....	7-13
Fan.....	7-14
Settings.....	7-14
Error Log.....	7-14
Calibration.....	7-15
Date and Time.....	7-16

Temperature Display Unit .....	7-20
TWB Setting/Activating (adjustable temperature) .....	7-21
Program Preferences .....	7-22
Configuration.....	7-25
Programming .....	7-26
End of Program.....	7-26
Instructions .....	7-26
<b>Chapter 8 Shut-down .....</b>	<b>8-1</b>
Shutting the refrigerated incubator Down .....	8-1
<b>Chapter 9 Cleaning and Disinfection .....</b>	<b>9-1</b>
Cleaning.....	9-1
Cleaning Exterior Surfaces.....	9-1
Wipe / Spray Disinfection .....	9-1
Preparing the Manual Wipe/Spray Disinfection .....	9-2
Pre-disinfection .....	9-3
Cleaning.....	9-4
Final Disinfection.....	9-4
<b>Chapter 10 Maintenance.....</b>	<b>10-1</b>
Inspections and Checks .....	10-1
Regular Checks.....	10-1
Semi-annual Inspection .....	10-1
Service Intervals.....	10-2
3-monthly service .....	10-2
Annual Service.....	10-2
Preparing Temperature Calibration.....	10-3
Comparison Measurement Procedure.....	10-3
Temperature Calibration Procedure .....	10-4
Replacing the Door Seal.....	10-5
Replacing the Power Cord.....	10-6
Returns for Repair.....	10-6
<b>Chapter 11 Disposal.....</b>	<b>11-1</b>
Overview of Materials Used .....	11-1
<b>Chapter 12 Error Codes .....</b>	<b>12-1</b>
<b>Chapter 13 Technical Data .....</b>	<b>13-1</b>
<b>Chapter 14 Spare Parts and Accessories .....</b>	<b>14-1</b>
<b>Chapter 15 Device Log .....</b>	<b>15-1</b>
<b>Chapter 16 Contact .....</b>	<b>16-1</b>

DOMINIQUE DUTSCHER SAS

## List of Figures

Figure 3-1 Table-top refrigerated incubators, dimensions and required clearances .....	3-3
Figure 3-2 Floor stand refrigerated incubators, dimensions and required clearances .....	3-4
Figure 3-3 Lift Points.....	3-5
Figure 4-1 Heratherm IMP 180 Front View .....	4-2
Figure 4-2 Heratherm IMP 180 Rear View.....	4-3
Figure 4-3 Heratherm IMP 400-S Front View.....	4-4
Figure 4-4 Heratherm IMP 400-S Rear View .....	4-5
Figure 4-5 IMP Peltier refrigerated incubator in cooling mode .....	4-6
Figure 4-6 IMP Peltier refrigerated incubator in heating mode .....	4-6
Figure 4-7 PT100 Sensor IMP 180.....	4-7
Figure 4-8 PT100 Sensor IMP 400.....	4-8
Figure 4-9 Signal Interfaces and Power Socket .....	4-9
Figure 4-10 T 2A H 250V fuse.....	4-10
Figure 4-11 Access Ports .....	4-11
Figure 4-12 Shelf System .....	4-12
Figure 4-13 Additional Tube Access Ports .....	4-13
Figure 5-1 Sliding the Retaining Spring into the Support Rail.....	5-1
Figure 5-2 Installing the Shelving .....	5-2
Figure 5-3 Support Rail Installation.....	5-3
Figure 5-4 Removing the Air Baffle .....	5-4
Figure 5-5 Removing the bottom plate .....	5-5
Figure 5-6 Removing the left and right support profiles.....	5-5
Figure 5-7 Shelf Support Bracket Installation .....	5-6
Figure 5-8 Perforated Shelf .....	5-6
Figure 5-9 AC Power Supply Socket.....	5-8
Figure 5-10 Alarm Contact Connection Example.....	5-12
Figure 7-1 Control Panel for Heratherm IMP Series and IMP-S Series refrigerated incubators. ....	7-1
Figure 10-1 Door Seal Replacement .....	10-4





## Safety Notes

### Basic Operating Precautions

These operating instructions describe Heratherm refrigerated incubators.

Heratherm refrigerated incubators have been manufactured to the latest state of the art and have been tested thoroughly for flawless functioning prior to shipping. However, the refrigerated incubator may present potential hazards, particularly if it is operated by inadequately trained personnel or if it is not used in accordance with the intended purpose. Therefore, the following must be observed for the sake of accident prevention:

- Never step into the unit.
- Heratherm refrigerated incubators must be operated by adequately trained and authorized professional personnel.
- Heratherm refrigerated incubators must not be operated unless these operating instructions have been fully read and understood.
- The present operating instructions, applicable safety data sheets, plant hygiene guidelines and the corresponding technical rules issued by the operator shall be used to create written procedures targeted at personnel working with the subject matter device, detailing:
  - the decontamination measures to be employed for the refrigerated incubator and the accessories used with it,
  - the safety precautions to be taken when processing specific agents,
  - wearing protective equipment when handling e.g. microbiological and biological samples
  - the measures to be taken in case of accidents.
- Repair work on the refrigerated incubator must be carried out only by trained and authorized expert personnel.
- The contents of these operating instructions are subject to change at any time without further notice.
- Concerning translations into foreign languages, the German version of these operating instructions is binding.
- Keep these operating instructions close to the refrigerated incubator so that safety instructions and important information are always accessible.
- Drying time after decommissioning, as Transport 2 hours.

- Should you encounter problems that are not detailed adequately in these operating instructions, please contact Thermo Electron LED GmbH immediately for your own safety.

## Operational Safety Rules

The following rules must be heeded when working with Heratherm refrigerated incubators:

- Observe the sample weight limits specified for your Heratherm refrigerated incubator as a whole and its shelving in particular; see “[Technical Data](#)” on [page 13-1](#).
- Arrange the samples evenly throughout the work space, making sure not to place them too closely to the interior walls to ensure a uniform temperature distribution.
- Do not load your Heratherm refrigerated incubator with substances that exceed the capabilities of the available lab apparatus and Personal Protection Equipment to provide sufficient degrees of protection to users and third parties.
- Check the door seal every six months for proper sealing performance and possible damage.
- Do not process any samples containing hazardous chemical substances that may be released into the ambient air through defective seals or may cause corrosion or other defects on parts of the Heratherm refrigerated incubator.
- The tempering of defined substances or materials with higher moisture content can result in increased condensation in the chamber. Measures on [page 6-2](#) must be observed.

## Warranty





Thermo Fisher Scientific warrants the operational safety and functions of the Heratherm refrigerated incubators only under the condition that:

- the refrigerated incubator is operated and serviced exclusively in accordance with its intended purpose and as described in these operating instructions,
- the refrigerated incubator is not modified,
- only original spare parts and accessories that have been approved by Thermo Scientific are used (third-party spares without Thermo Scientific approval void the limited warranty),
- inspections and maintenance are performed at the specified intervals,
- an operation verification test is performed after each repair activity.











The warranty is valid from the date of delivery of the refrigerated incubator to the customer.

## Explanation of Safety Information and Symbols

### Safety Notes and Symbols Used Throughout These Operating Instructions

	 <b>DANGER</b> Indicates a hazardous situation which, if not avoided, will result in death or serious injuries.
	 <b>WARNING</b> Indicates a hazardous situation which, if not avoided, could result in death or serious injuries.
	 <b>CAUTION</b> Indicates a situation which, if not avoided, could result in damage to equipment or property.
	 <b>NOTE</b> Is used for useful hints and information regarding the application.

## Additional Symbols for Safety Information

	Wear safety gloves!
	Wear safety goggles!
	Harmful liquids!
	Electric shock!
	Hot surfaces!
	Fire hazard!
	Explosion hazard!
	Suffocation hazard!
	Biological hazard!
	Contamination hazard!
	Danger of tipping!

## Symbols on the refrigerated incubator



Observe operating instructions

120 VAC

120 Volts AC power socket

230 VAC

230 Volts AC power socket

NC PE NO COM

Alarm contact

**T 2A H**  
**250 V**

Fuse 2 A, slow blow, high breaking current, 250 volt



Hot surfaces!



EAC conformity mark: confirms conformity according to all technical regulations of the Eurasian customs union (Russia, Kazakhstan and Belarus)

RS 232

RS 232 interface

## Intended Purpose

### Intended Purpose of the refrigerated incubator

Heratherm refrigerated incubators are laboratory equipment for tempering (cooling and heating) of defined substances and materials. They serve for the preparation and cultivation of cell and tissue cultures. The devices employ precision temperature control for simulating the particular physiological environment for these cultures.

### Incorrect Use

To avoid the risk of explosion do not load the refrigerated incubator with tissue, material, or liquids that:

- are easily flammable or explosive,
- release vapor or dust that forms combustible or explosive mixtures when exposed to air,
- release poisons,
- do not pour any liquids on the bottom of the interior surface or into a collecting basin inside the unit.
- release dust
- exhibit exothermic reactions
- are pyrotechnical substances
- refrain also from pouring any liquids onto the internal base plate or inserting bowls filled with liquids into the sample compartment.

## Standards and Directives

The refrigerated incubator complies with the following standards and guidelines:

- IEC EN 61010 - 1, IEC EN 61010 - 2 - 010
- Low Voltage Directive 2014/35/EC
- EMC Directive 2014/30/EC
- China EEP Hazardous Substances Information  
<http://www.thermofisher.com/us/en/home/technical-resources/rohs-certificates.html>

Additionally, the refrigerated incubator is in compliance with many other international standards, regulations and directives not listed here. Should you have any questions regarding compliance with national standards, regulations and directives applicable for your country, please contact your Thermo Fisher Scientific sales organization.

## Delivery of the refrigerated incubator

### Packaging

Heratherm refrigerated incubators are delivered in a rugged packaging box. All packaging materials can be separated and are reusable:

Packaging materials

Packaging carton: Recycled paper

Foam elements: Styrofoam (CFC-free and HFC-free)

Pallet: Chemically untreated wood

Packaging film: Polyethylene

Packaging ribbons: Polypropylene

### Acceptance Inspection

After the refrigerated incubator has been delivered, check the delivery immediately for:

- completeness,
- possible damage.

If components are missing or damage is found on the refrigerated incubator or the packaging, in particular damage caused by humidity and/or water, please notify the carrier as well as Thermo Scientific Technical Support immediately.

	<div data-bbox="467 1402 782 1486"> <b>WARNING</b></div> <p data-bbox="812 1444 977 1476">Risk of injury</p> <p data-bbox="454 1507 1253 1665"><b>Should sharp edges have formed in damaged areas or elsewhere on the device, take all necessary precautions to protect personnel handling the refrigerated incubator. For example, have them wear protective gloves and other personal protection equipment.</b></p>
--	--

## Scope of Supply

### refrigerated incubators

Quantity of components supplied (pieces)	IMP Series
Perforated shelves	2
Support rail for shelf table-top refrigerated incubators	2
Shelf support	4
Power cord	1
Connector, potential-free contact	1
Clip springs for table-top refrigerated incubators	2
Plug for standard access port	2
Anti-tilt anchor	1
Operating manual	1
Summarized Safety Instructions	1
Condensed water dish IMP 180	1
Condensed water dish IMP 400	2



# Installation

## Ambient Conditions

### Location Requirements



The refrigerated incubator must only be operated in a location that meets all of the ambient condition requirements listed below:

- Installation location indoors in dry areas free from drafts.
- The dust burden may not exceed the contamination category 2 based on EN 61010-1. Using the refrigerated incubator in an atmosphere with electrically conductive dust is prohibited.
- The minimal distance to adjacent surfaces must be observed on all sides (see Section “Space Requirement” on page 3-3)
- The operating room must be equipped with appropriate ventilation.
- Solid, level, fire-proof surface; no flammable materials opposite to the rear panel of the refrigerated incubator.
- Vibration-proof substructure (floor stand, lab table) capable of bearing the dead weight of the refrigerated incubator and its accessories (particularly if two devices are stacked).
- The electrical circuitry of the refrigerated incubator has been designed for an operating height of up to 2000 m above sea level.
- If a high-voltage test is to be performed on the unit, it must first be heated for around 30 minutes at 50°C.
- The ambient temperature must be within a range of +18 °C to +28 °C (64 °F to 82 °F).
- Avoid direct exposure to sunlight.
- Devices that produce excessive amounts of heat must not be placed near the refrigerated incubator.
- Place the refrigerated incubator on a floor stand (option; to be ordered separately), never on the lab floor. This prevents the penetration of dust or dirt into the device.
- Power line voltage variations must not exceed  $\pm 10$  % of the nominal voltage.
- Transient surges must lie within the range of levels that normally occur in the power supply system. The impulse withstand voltage based on surge category II of IEC 60364-4-443 shall be applied at the nominal voltage level.

- Relative humidity up to 70%, non condensing, at an ambient temperature of 28°C.
- Should condensation exist, wait until the moisture has evaporated completely before connecting the refrigerated incubator to a power source and powering up.

	 <b>WARNING</b>	<b>Humidity</b>
<p><b>After transport or storing under humid conditions a drying-out process must be performed. During the drying-out process the equipment cannot be assumed to meet all the safety requirements of the IEC 61010-2-010 standard. The drying-out period is 2 hours.</b></p>		

- Consider installing one dedicated upstream circuit breaker per refrigerated incubator to avoid multiple device failures in case of an electrical fault.

	 <b>WARNING</b>	<b>Contamination hazard</b>
<p><b>Do not place the refrigerated incubator directly on the lab floor, but mount it on the floor stand or on a lab work surface (option; to be ordered separately). Contaminants, such as bacteria, viruses, fungi, prions, and other biological substances may use the open door to migrate easily from the floor into the refrigerated incubator's work space.</b></p>		

## Intermediate Storage

When the refrigerated incubator is placed in intermediate storage, which is permissible for a maximum of four weeks, make sure that the ambient temperature is between 20 °C to 60 °C (68 °F to 140 °F) and the maximum relative humidity does not exceed 90%, non-condensing.

## Room Ventilation

Heat dissipating from the refrigerated incubator during continuous operation may cause a change in the room climate.

- Therefore, the refrigerated incubator must only be installed in rooms with sufficient ventilation.
- Do not install the refrigerated incubator in room recesses without ventilation.
- When several devices are to be placed in the same room, additional ventilation may have to be provided as necessary.
- To avoid any impact of the heat dissipated by the refrigerated incubator on the ambient climate the room must be vented by means of a laboratory-grade ventilation system that complies with applicable local and national health and safety regulations and has sufficient capacity.
- If excessive temperatures tend to occur in the operating room, be sure to provide a thermal protection means that cuts out the power supply to mitigate the impact of over-temperature scenarios.

## Space Requirement

When installing the refrigerated incubator, make sure that the installation and supply connections remain freely accessible.

The specified side clearances represent minimum distances.

### Table-top refrigerated incubators

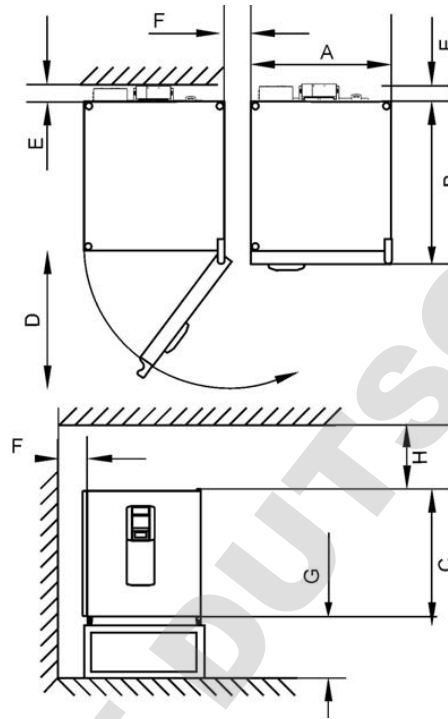

Figure 3-1 Table-top refrigerated incubators, dimensions and required clearances

Table 3-1 refrigerated incubator Dimensions

Model	A (mm/inch)	B (mm/inch)	C (mm/inch)	D (mm/inch)
IMP 180	640/25.2	738/29.1	920/36.2	650/25.6

\* Depth of handle /display (66 mm/2.6 in) not included in overall depth specified; height of adjustable feet (36 mm/1.4 in) not included in overall height specified.

Table 3-2 Required Clearances

E (mm/inch)	F (mm/inch)	H (mm/inch)	I (mm/inch)
130/5,1	150/5,9	200/7,9	300/11.8

## Floor Stand refrigerated incubators

400 liter units

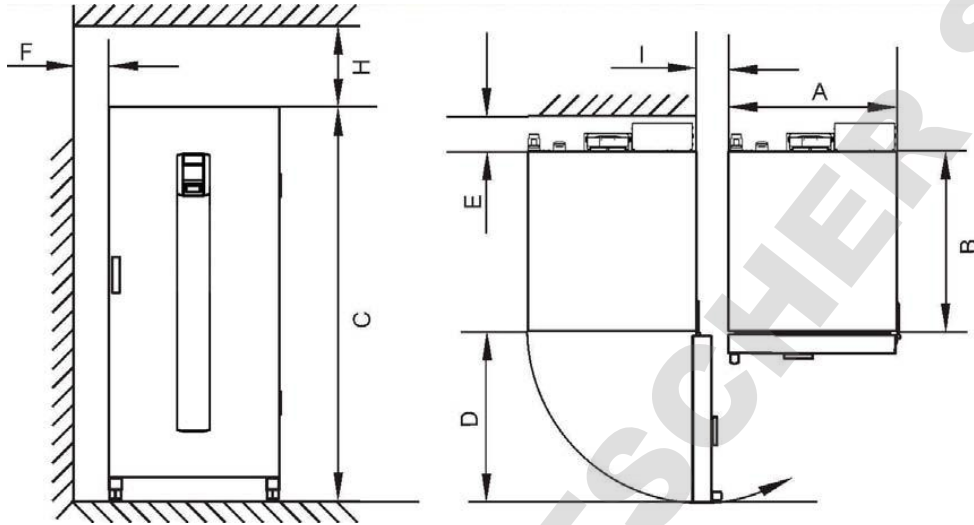

Figure 3-2 Floor stand refrigerated incubators, dimensions and required clearances

Table 3-3 refrigerated incubator Dimensions

Model	A (mm/inch)	B (mm/inch)	C (mm/inch)	D (mm/inch)
IMP 400	755/29.7	770/30.3	1655/65.2	810/31.9

\* Depth of handle /display (66 mm/2.6 in) not included in overall depth specified. Width of hinge (23 mm/0,91 in) not included in overall width.

Table 3-4 Required Clearances

E (mm/inch)	F (mm/inch)	G (mm/inch)	H (mm/inch)	I (mm/inch)
150/5,9	150/5,9	360/14,2	200/7.9	50 / 2

## Transport

	<div style="border: 1px solid black; padding: 5px;"><div style="display: flex; align-items: center;"><div style="background-color: yellow; border: 1px solid black; padding: 2px 5px;"> <b>WARNING</b></div><div style="margin-left: 10px;"><b>Humidity</b></div></div><p>After transport or storing under humid conditions a drying-out process must be performed. During the drying-out process the equipment cannot be assumed to meet all the safety requirements of the IEC 61010-2-010 standard. The drying-out period is 2 hours.</p></div>
--	---

### Table-top refrigerated incubators

For transport, do not lift the refrigerated incubator using the doors or components attached to the refrigerated incubator as lift points.

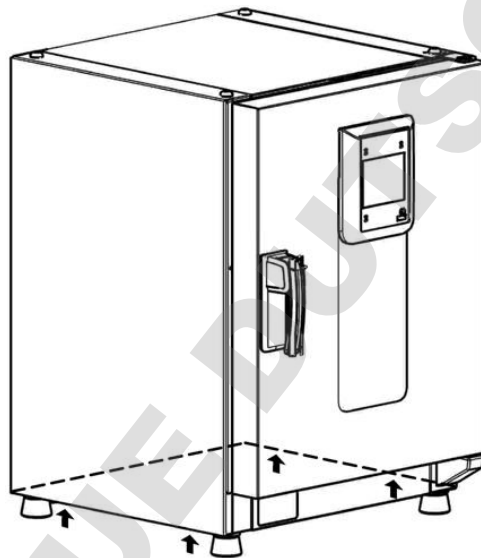



Figure 3-3 Lift Points



	<div style="border: 1px solid black; padding: 5px;"><div style="display: flex; align-items: center;"><div style="background-color: yellow; border: 1px solid black; padding: 2px 5px;"> <b>CAUTION</b></div><div style="margin-left: 10px;"><b>Heavy loads! Lift with care!</b></div></div><p>To avoid injury through physical strain, such as strain traumata and slipped discs, do not attempt to lift the refrigerated incubator alone!</p><p>To avoid injury through dropped loads, be sure to wear Personal Protection Equipment, such as safety shoes, when lifting the refrigerated incubator.</p><p>To avoid crushing your fingers or hands (particularly in a closing door) or damaging the refrigerated incubator, do not use any other lift points than those indicated in the illustration above.</p></div>
--	--

## Floor stand refrigerated incubators



The floor stand refrigerated incubators come equipped with four (4) casters. The lever for releasing the caster is located above the locking lever. After positioning the unit in its installation location ensure that the locking levers are pressed down on the casters.

To ensure the degree of stability specified by safety requirements the front casters must be turned so that they are facing forward after the unit has been positioned in its installation location and the locking levers pressed down on these casters.

	 <b>CAUTION</b> <b>Danger of tipping when moving!</b>
	<p>Disconnect the unit from the power source before moving it.</p> <p>Unscrew the wall mounts/supports from the wall.</p> <p>Retract the spacers.</p> <p>Move the Heratherm floor stand units with caution.</p> <p>When moving the unit always give particular attention to protruding items, such as door handle, spacers, etc.</p> <p>Quick starts and stops can result in tipping!</p> <p>Always ensure that the doors are closed when moving the unit.</p>

## Stacking Table-Top Units

Two IMP 180 can be stacked without use of a stacking kit. The kit is recommended when stacking with an oven or a unit with decontamination cycle, to avoid temperature impact.

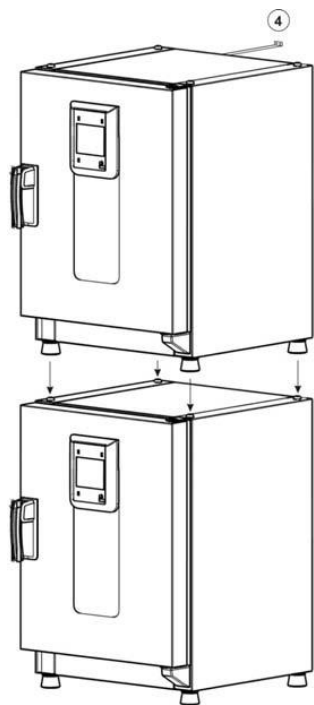

1	2 x Anti-tilt anchor
---	----------------------

Two IMP 180 can be stacked without use of a stacking kit. The kit is recommended when stacking with an oven or a unit with decontamination cycle, to avoid temperature impact.

**NOTE**

Stacking adapter

Two IMP 180 can be stacked without stacking adapter. A stacking adapter kit is recommended when an oven or a unit with decontamination routine is stacked to avoid temperature impact.

## Installing the Anti-tilt Anchor

### Table-top refrigerated incubators

The Heratherm table-top refrigerated incubators must be secured with anti-tilt anchors which are connected to a solid part of a building. The anti-tilt anchor is to be mounted in the middle position (2) or if not possible on the side opposite of the door hinges.

Bend the fixing tabs of the anti-tilt anchor up on one side and down on the other by an angle of approx. 90°.

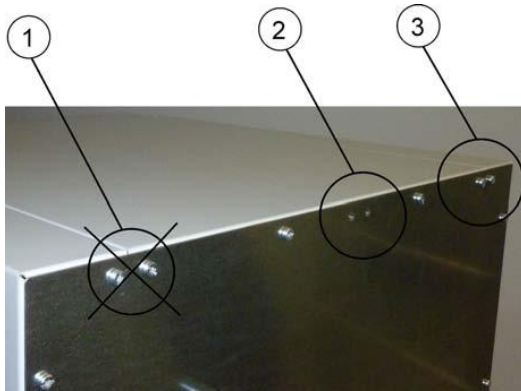

1. Do not use this position if the door is hinged on this side. Right-hand hinges represent the standard configuration.
2. Preferred position.
3. Alternative position. Do not use if the door is hinged on this side.

Remove the bracket screws. Use the preferred position, if possible.

Fix the anti-tilt anchor with the bracket side down to the unit.

Position the unit with the anti-tilt anchor to in an angle of approx. 90° +/- 20%.

Take care that the stacking feet of the unit are still in correct place on the lower unit or on the stacking adapter.

Fix the anti-tilt anchor to a solid part of the building.



## Floor stand refrigerated incubators

### NOTE

Heratherm floor stand refrigerated incubators must always be attached to the wall using two (2) retaining brackets on the outer left and right side on the back of the unit.

When operating under maximum environment- and condition of employment and when using low setpoint temperature can lead to performance losses in stacked devices.



Remove the screws.

Attach the end of the retaining bracket that is facing downward to the unit.

Align the device at roughly 90°, +/-20° to the retaining bracket.

Affix the retaining bracket to the wall.



**Unsafe part of the building!**

**Install the anti-tilt anchor to a solid part of the building, which is able for shoring loads.**

**The installation has to be carried out by qualified personnel only.**

**The connection to the building must be carried out with appropriate screws and dowels according to the consistence of the building part.**

Additionally, the following caution notes must be heeded at all times:



**Risk of overheating with stacked devices**

To avoid the risk of electrical components and the outer enclosure overheating or temperature control failing due to insufficient ventilation, do not exceed the specified stacking height!



**Risk of tipping and dropping of stacked devices**

You should be aware at all times that stacked devices do not form a stable unit, even when the stacking pads and frames are correctly used. The top device may tip over and drop down when being transported in a stack. To avoid injury to persons and damage to equipment, do not attempt to move stacked devices as a unit! Separate and move each device one by one, then re-stack them. Thermo Scientific don't give warranty for stacking equipment of other manufacturer's, this occurs at own risk.

## Product Description

### Heratherm IMP Series refrigerated incubator Overview

IMP Series advanced protocol microbiological refrigerated incubators come equipped with the following features:

- high-precision work space temperature control, adjustable in steps of one-tenth of a degree from 5°C (32°F) up to 70°C (158°F)
- Peltier-air-air-system with work space and outside fan
- countdown, fixed-time, and weekly timers for timed process control
- two perforated shelves
- an access port for tubing, sensor leads, etc.

#### Door frame heater

In Heratherm IMP series incubators frame heating in the inner door-box is installed to prevent or reduce the risk of condensate formation.

#### Over-temperature protection (TWB)

The monitor temperature (maximum over temperature) can be set on the display manually. When the maximum temperature is exceeded over the TWB the Peltier heating function is switched off permanently and can only be reset by the user manually on the display again (Instructions: "Settings" on page 7-21).

**Product Description**  
**Heratherm IMP Series refrigerated incubator Overview**

The individual features of IMP Series refrigerated incubators are shown in the figures below.

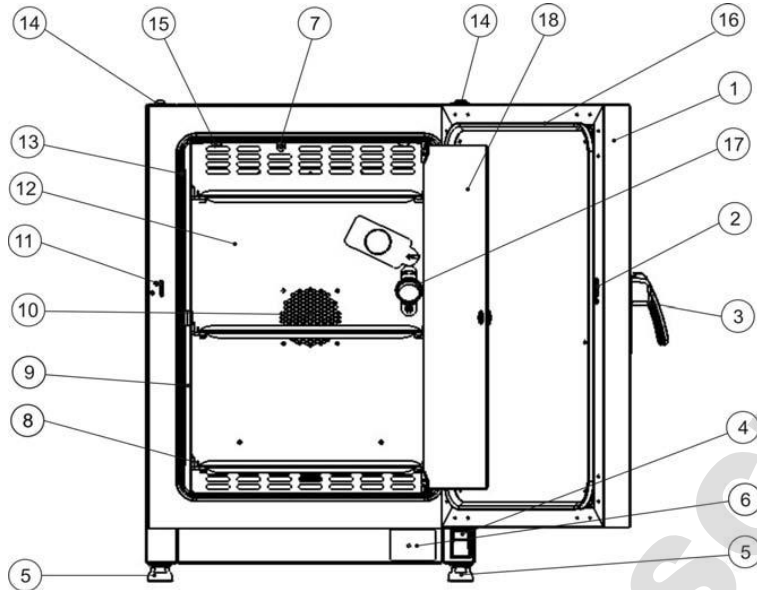

**Figure 4-1 Heratherm IMP 180 Front View**

- [1] Outer door
- [2] Door latch cutout
- [3] Door latch and handle
- [4] Door hinge, lower
- [5] Leveling foot
- [6] Nameplate
- [7] Temperature sensor
- [8] Support rail for perforated shelf
- [9] Shelf support
- [10] Fan opening, air baffle
- [11] Door hook catch
- [12] Air baffle
- [13] Door seal
- [14] Stacking pad
- [15] Spring
- [16] Door frame heater
- [17] Access port
- [18] Glass door

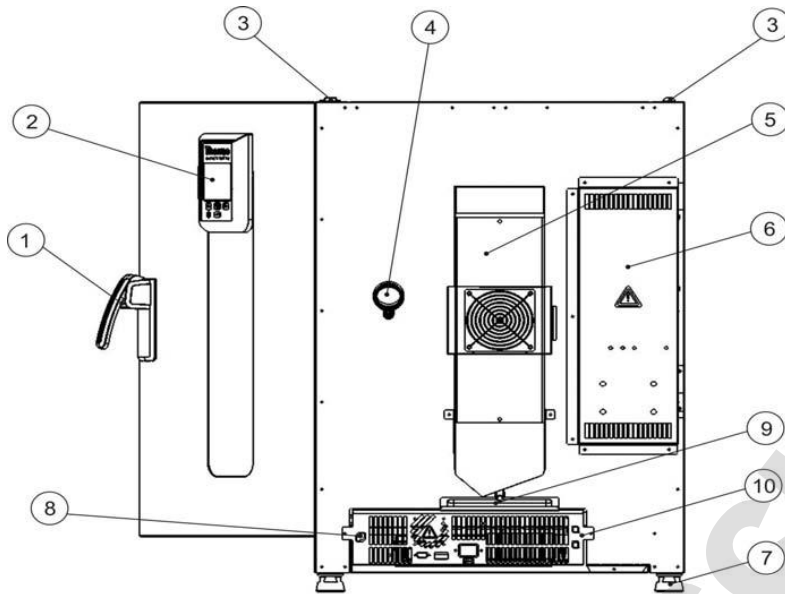

**Figure 4-2 Heratherm IMP 180 Rear View**

- [1] Door latch and handle
- [2] Control panel
- [3] Stacking pad
- [4] Access port
- [5] Peltier system with outside fan
- [6] Electronics compartment
- [7] Leveling foot
- [8] Sample sensor connection
- [9] Condense water drain with dish
- [10] Electro compartment

**NOTE**

**Condensate water dish**

Prior to the commissioning of the unit the condensate water dish is to be installed according to figure 4-2.

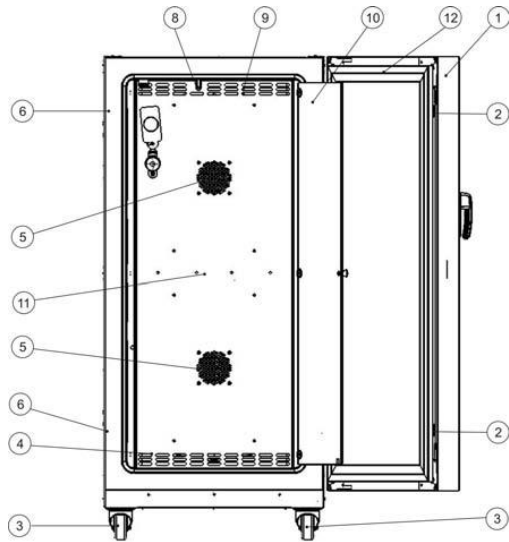

**Figure 4-3 Heratherm IMP 400 Front View**

- [1] Outer door
- [2] Door latch
- [3] Unit caster
- [4] Air baffle
- [5] Perforated shelf
- [6] Door hook catch
- [7] Glass door latch
- [8] Temperature sensor
- [9] Access port
- [10] Glass door
- [11] Fan opening, air baffle
- [12] Door frame heater

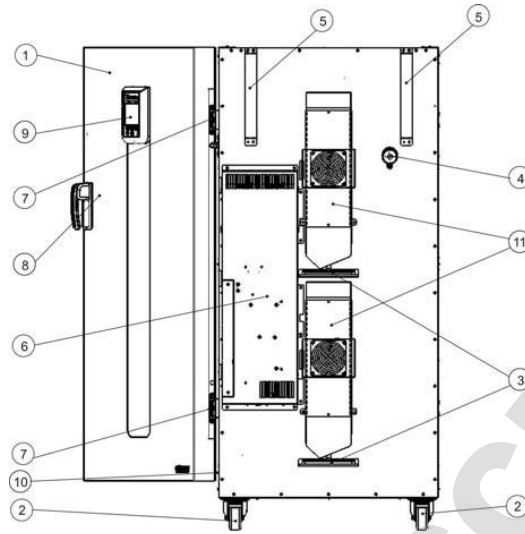

**Figure 4-4 Heratherm IMP 400 Rear View**

- [1] Outer door
- [2] Unit caster
- [3] 2 x condensate water drain with dish
- [4] Access port
- [5] Anti-tilt anchor
- [6] Electronics compartment
- [7] Hinge
- [8] Door handle
- [9] Display
- [10] Nameplate on sidewall
- [11] 2 x Peltier system with outside fan

<b>NOTE</b>	<p><b>Condensate water dish</b></p> <p>Prior to the commissioning of the unit the both condensate water dishes are to be installed according to figure 4-4.</p>
-------------	---

## Peltier System

The installed "Peltier -air-air system" (see Figure 4-5 and 4-6) is integrated in the rear wall and designed for tempering (cooling and heating) of the usable space. The Peltier module consists of two heat sinks (heat exchanger), each equipped with an axial fan. In cooling mode, heat from the usable space is absorbed and conducted to the environment on the device outside. In heating mode the heat is absorbed from the outside of the unit and emitted into the device usable space.

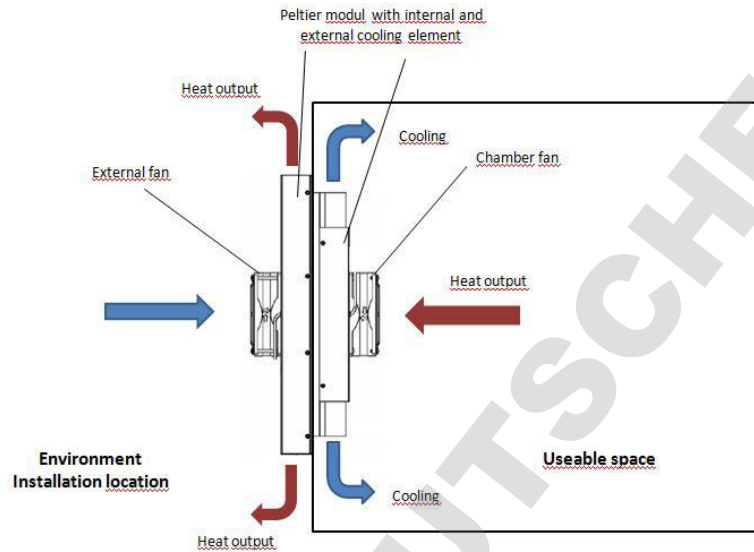

Figure 4-5 IMP Peltier refrigerated incubator in cooling mode

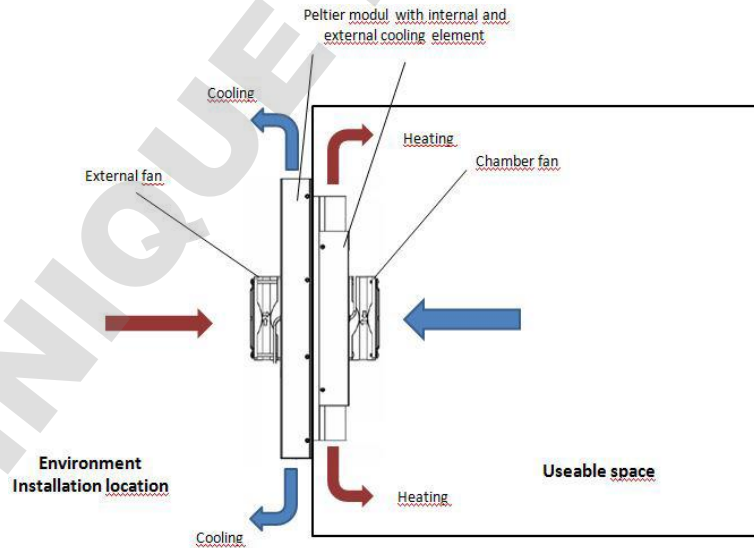

Figure 4-6 IMP Peltier refrigerated incubator in heating mode



## Safety Devices

The refrigerated incubators are equipped with the following safety features:

- a sample protection feature that safeguards the samples against destruction through overheating in case of controller failure;
- dual sensor: if one sensor fails, the other will take over.
- an overheat protection cut-out feature class 2 (TWB), according to DIN 12880, that shuts down the refrigerated incubators IMP completely when excessive temperatures occur in the workspace;
- an alarm relay that is energized, along with audible and visual alarms, to indicate errors encountered during operation;
- dual fuses rated at 15 amperes.

## Work Space Atmosphere

To ensure undisturbed operation, the ambient temperature in the operating room must be at least 18 °C (64.4 °F).

The Peltier element controls the work space temperature of the refrigerated incubator from 5 °C (41 °F) up to the maximum of 70 °C (158 °F).

## Sensing and Control System

The PT 100-type sensor for the control of the work space temperature and for the thermal protection is installed on the bottom of table-top refrigerated incubators and in the top of floor stand refrigerated incubators.

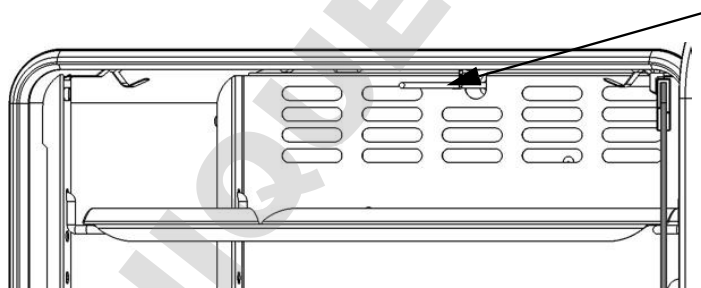
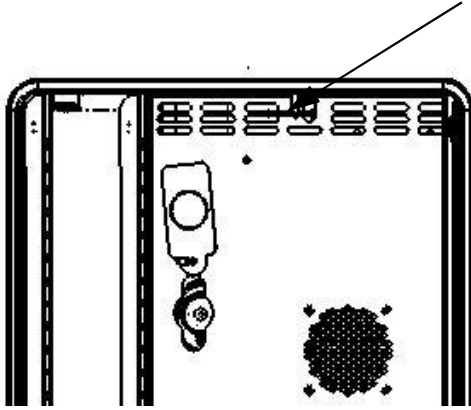

Figure 4-7 PT100 Sensor IMP 180



**Figure 4-8 PT100 Sensor IMP 400**

The work space temperature sensor provides the inputs to the refrigerated incubator's built-in controller, which continuously compares the measured values to the user-specified set value and adjusts the heaters according to the result.

**NOTE**

**Do not remove the protection hose from the sensor.  
Protect the sensor from mechanical damage.**

The unit has a thermal protection function that is factory-preprogrammed and not adjustable. It protects the cultures in the work space from overheating: Thermal protection kicks in on a brief violation of the upper limit, based on the defined setpoint temperature, at between 2 and 3 °C (35.6 °F and 37.4 °F) (37 °C (99 °F): 2 °C (35.6 °F), > 50 °C (122 °F): 3 °C (37.4 °F)), automatically reducing the work space temperature to the user-specified set value and allowing the incubation process to be continued even in case of a controller malfunction. If the thermal protection is activated, the error message (E111) "Temperature too high" appears in the display window and an audible alarm is sounded.

When the user acknowledges the error message, the red alarm icon (D4 in [figure 7-1](#) on [page 7-1](#)) is illuminated and the Temperature Set Value icon (see [table 7-3](#) on [page 7-4](#)) is highlighted by a red border to indicate that thermal protection has kicked in.

## Data Communications & Alarm Interface

All signal connections are installed in the electrical interface panel at the rear of the refrigerated incubator.

### RS-232 Interface

The RS-232 interface (item 2 in [figure 4-9](#) below) may be used to connect Heratherm refrigerated incubators to the serial interface port of a computer to allow for the computer-aided acquisition and documentation of major operating parameters (temperature, error codes, etc.).

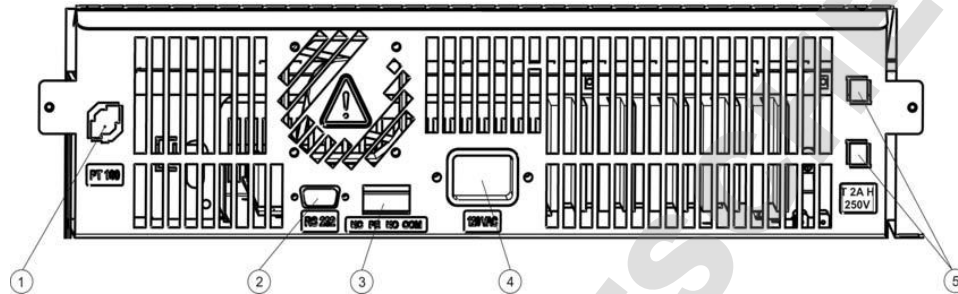

- [1] Sample Sensor connection
- [2] RS 232 interface
- [3] Alarm contact
- [4] Power socket
- [5] 2 fuses T 2A H 250 V, for socket

**Figure 4-9 Signal Interfaces and Power Socket**

### Alarm Contact

The refrigerated incubator can be connected to an on-site, external alarm system (such as a private branch telephone exchange, a facility monitoring system, visual or audible alarm indicators). For this purpose, the devices come with a pre-wired potential-free alarm contact (item 3 in [figure 4-9](#)). The alarm contact is energized whenever an error occurs in an internal control loop or the refrigerated incubator's electrical circuits or hardware.

### AC Power Socket

The refrigerated incubator is connected to the AC supply mains via the socket (item 4 in [figure 4-9](#)), which accepts a power cord with an IEC standard plug.

### Fuses

#### 15 A device fuses

Two 15 A slow-blow fuses mounted on the refrigerated incubator's main electronic circuit board protect internal circuitry from the impact of excessive power consumption.

	<b>NOTE</b>
<p>Replacement should only be carried out by skilled and authorized qualified personnel of electrotechnology/signal engineering!</p>	

	<b>NOTE</b>	<b>Fuse replacement 15 A fuses</b>
<p>The device fuses are not user-serviceable. When the refrigerated incubator exhibits the typical signs of a blown fuse (no response to pressing the On/Off button, control panel remains extinguished, no heating operation), call Thermo Fisher Scientific Customer Service to have the fuses replaced.</p>		

### Replacement 2 A fuses socket

Access to the 2 A fuses for the electrical outlets Fig. 4-10 is performed by turning the grid lock on the fuse modules at the electronics unit.

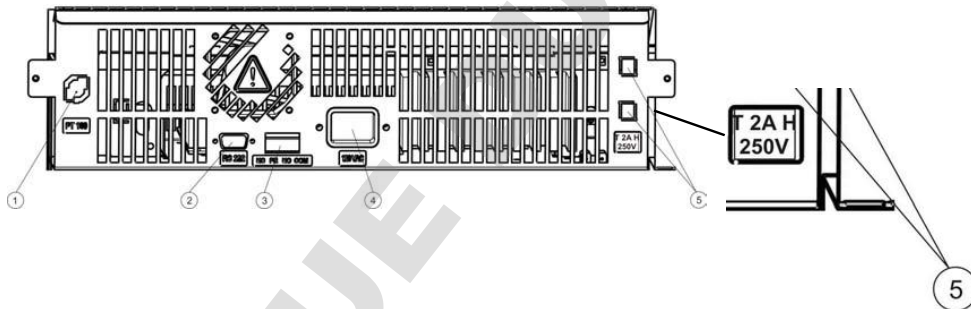

Figure 4-10 T 2A H 250V fuse

	<b>CAUTION</b>	<b>Fuse replacement 2 A fuses</b>
<p>Only compatible fuses 2 A, slow blow, high breaking current, 250 V are to be used for replacement.</p>		

## Work Space Components

### Inner Chamber

All components of the work space are made of corrosion-resistant stainless steel and have an absolutely smooth and easy-to-clean surface. Any embossings have a large radius.

### Access Port

A re-sealable, capped access port (can be closed off using the plugs delivered with the unit) (Heratherm IMP 180 and IMP 400-S only, see figure 4-7) allows cables, hoses or additional sensor leads to be routed into the work space of the refrigerated incubator.

The access port [2] has a diameter of 42 mm.

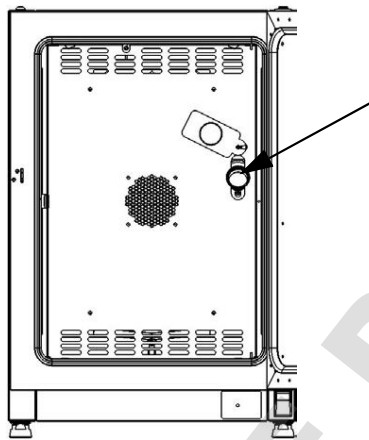

Figure 4-11 Access Port

<b>NOTE</b>	<b>Operating conditions</b>
<p>When accessories are to be operated in the work space of the refrigerated incubator, the ambient condition requirements must be observed (see table below). The energy introduced into the work space has an impact on the lower end of the temperature control range. When additional heating sources are introduced into the work space, temperature control may be adversely affected.</p>	
<p>It is recommended to close the access port as much as possible after inserting cable, hose, additional sensor to keep air exchange via the port to a minimum.</p>	

## Shelf System

The refrigerated incubator is supplied with two perforated shelves. The shelf support rails [1] have an alternating pattern of oblong and round perforations spaced evenly at 30 mm, allowing the shelf support brackets [8] to be inserted without any room for error, yet in a very flexible way to accommodate any required height of sample container. The shelves [2] have an integrated tilt protection and pull-out stop. For details on using the shelf system, see “[Installing the Shelf System](#)” on page 5-1.

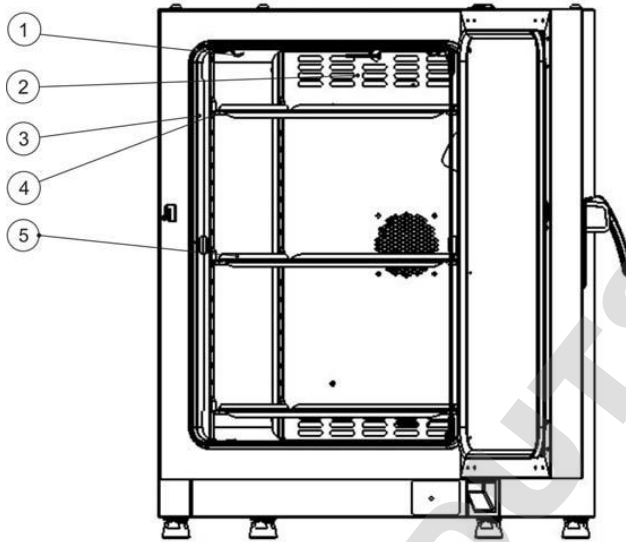

Figure 4-12 Shelf System

- [1] Retaining Springs (only for table-top refrigerated incubators)
- [2] Air Baffles
- [3] Support Rails
- [4] Shelf Support
- [5] Shelves

## Additional Tube Access Ports (Option)

Heratherm refrigerated incubators may be equipped with additional tube access ports in the side and top panels.

Available tube access port options are listed in [table 4-1](#) below.

**Table 4-1 Tube Access Ports for Heratherm refrigerated incubators (Option)**

Model	Side Panel Mounted Port, dia. in mm/inch	Top Panel Mounted Port, dia. in mm/inch
IMP	20/0.79 or 52/2.05	20/0.79 or 52/2.05

The tube access ports are mounted in fixed locations in the side and top panels (see [figure 4-13](#)).

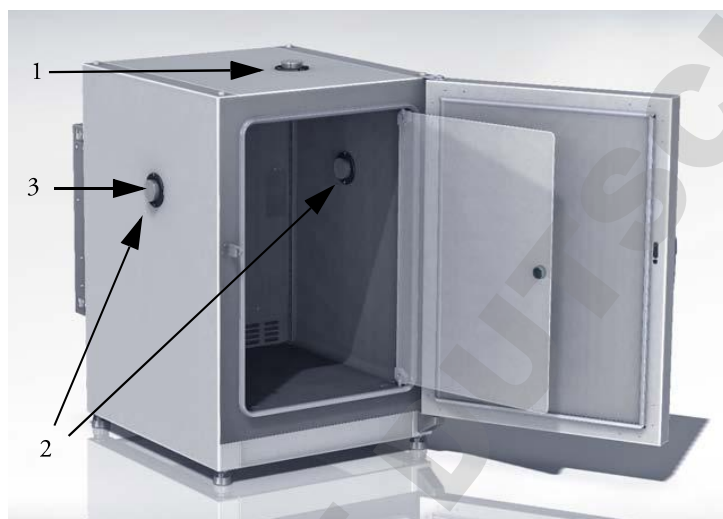

**Figure 4-13 Additional Tube Access Ports**

- [1] Top panel mounted tube access port
- [2] Side panel mounted tube access port
- [3] Sealing cap for side panel mounted tube access port

<b>NOTE</b>	<b>Access port</b>
<p>Once the cables, tubes or other conduits have been inserted, the tube access ports must be padded with the heat-resistant fiber pads shipped with the device and the cap must be mounted to seal the port as far as possible to keep air exchange via the port to a minimum.</p>	





## Installation procedures

### Table-top refrigerated incubators

#### Installing the Shelf System

The installation of the shelf system does not require any tools. The support rails are secured in place by spring action. Once the shelf support brackets have been inserted into the rails, the perforated shelves can be simply pushed onto their support hooks to complete the installation.

#### NOTE

The support rails of the floor stand refrigerated incubators cannot be removed.

#### Initial Installation

1. Peel off the protective foil from the support rails.
2. Push the retaining spring [1] into the guide on the support rail [2], making sure that the locking nub [3] on the retaining spring safely engages with the matching hole in the support rail.

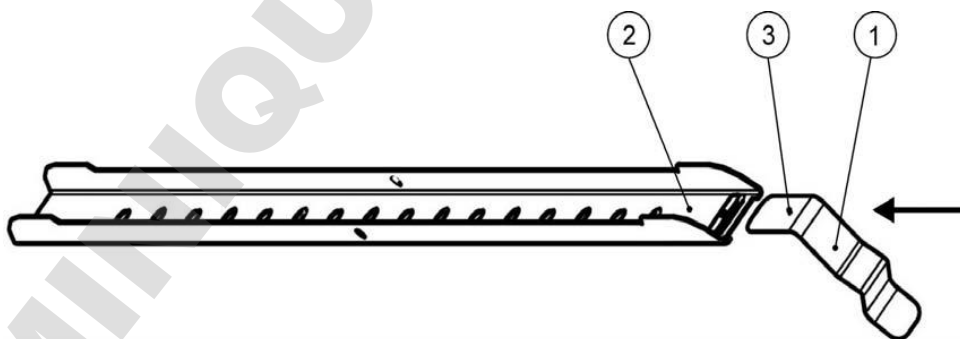
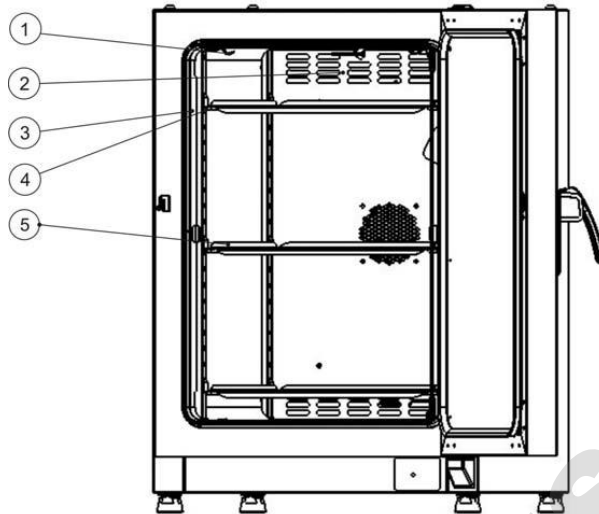

Figure 5-1 Sliding the Retaining Spring into the Support Rail

## Installing the Perforated Shelves

The illustration below shows the placement of the shelf system elements.



- [1] Air Baffles
- [2] Retaining Springs (only for table-top refrigerated incubators)
- [3] Support Rails
- [4] Shelf Support
- [5] Shelves

**Figure 5-2 Installing the Shelving**

## Preparing the usable space

Upon delivery, Heratherm refrigerated incubators are not in a sterile state. Before the initial start-up, the refrigerated incubator must be decontaminated.

The following work space components should be checked for cleanliness and disinfected prior to use:

- Support rails,
- Shelf support,
- Perforated shelves,
- Usable space surfaces,
- Work space seals and gaskets,
- Glass door

## NOTE

### Cleaning and disinfection

For details about the cleaning and disinfection of the refrigerated incubator, please refer to “Cleaning” on page 9-1.

## Installation or Removal of the Support Rails

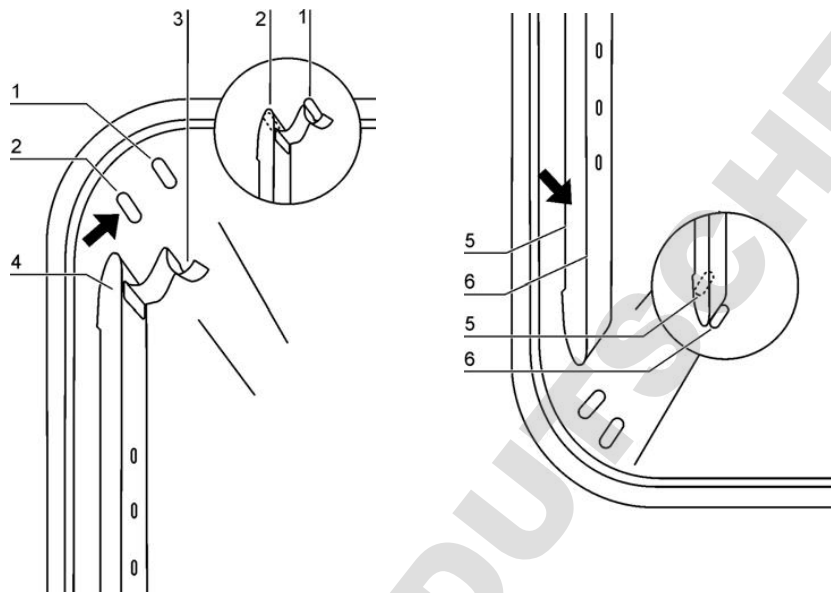

**Figure 5-3 Support Rail Installation**

The embossings at [2] and [5] act as lateral guides for the support rails, while the embossings at [1] and [6] secure the support rails in place. For the support rails to install correctly the retaining spring [3] must be facing upwards.

1. Place the support rail [4] on the lower embossing [6] and tilt it upwards against the work space side wall so that the rail is positioned over the two embossings at [5] and [2].
2. Clamp the retaining spring [3] behind the upper embossing [1].
3. To remove the support rails, pull the retaining spring tab down out of the embossing and remove the support rail assembly.

## Installing and Uninstalling the Air Baffle

Heratherm IMP Series refrigerated incubators are shipped from the factory with the air baffle readily pre-installed. Before the air baffle can be removed from the back wall, the support rails need to be uninstalled.

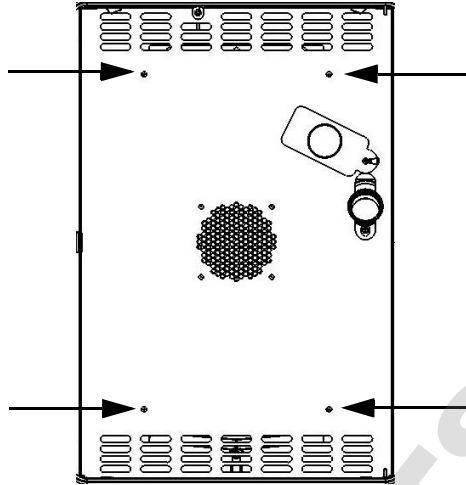

**Figure 5-4 Removing the Air Baffle**

1. Loosen the two screws [1] that hold the air baffle to the interior container back wall.
2. Grab the two retaining springs [2] at their tabs and the cut-out of the access port and pull them downwards out of the embossings, then take off the air baffle from the back wall.
3. For the air baffle to install correctly, the retaining springs must be facing upwards. Place the air baffle on the lower embossings and tilt it upwards against the back wall of the work space.
4. Clamp the two retaining springs [2] into the upper embossings.
5. Secure the air baffle against the interior container back wall by fastening the two screws at [1].

## Levelling the refrigerated incubator

1. Position a bubble level onto the center shelf.
2. Manually adjust the levelling feet until the shelf is horizontally aligned in all directions. Perform the adjustment of the levelling feet from left to right and from rear to front.

## Commissioning of floor stand refrigerated incubators

### Installing/Removing air baffles (IMP 400 Series)

The section below describes how to install/remove the bottom plate.

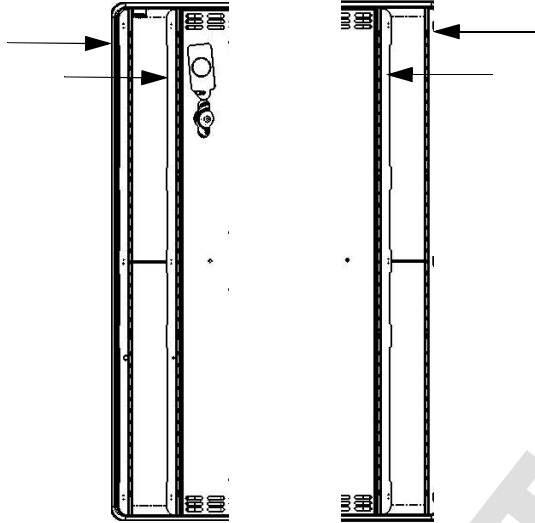

**Figure 5-5** Removing the bottom plate

1. Loosen and remove the four (4) screws in the bottom plate and then remove the bottom plate completely.

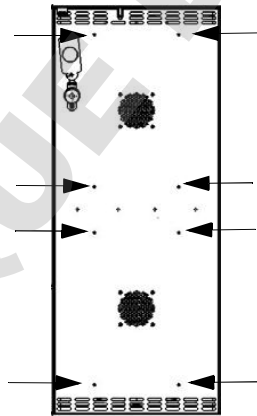

**Figure 5-6** Removing the left and right support profiles

Loosen and remove the eight (8) screws for the left and right support profiles and then take out the lateral air baffles.

Check to ensure that the air baffles are securely screwed into place after cleaning and moving the unit.

## Commissioning, general

### Installing the Shelf Support Brackets

1. Insert the shelf support bracket [3] into the perforations [1] of the support rail and tilt it downwards.
2. Make sure that the two vertical elements [2] of the shelf support bracket butt against the support rail.

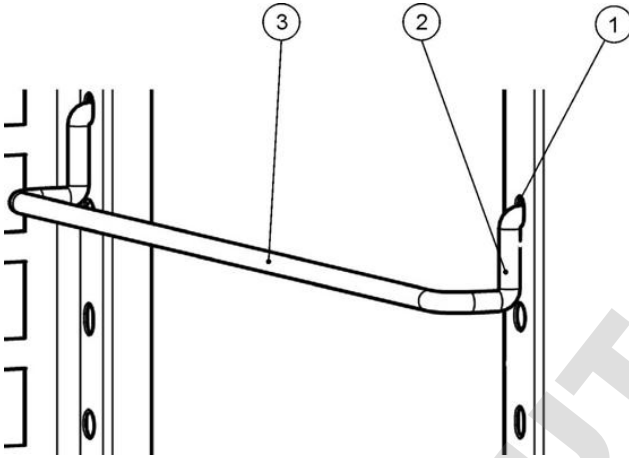
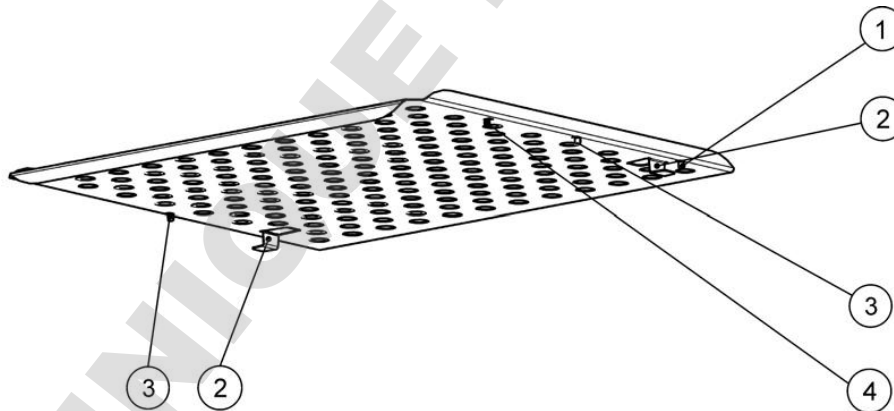

Figure 5-7 Shelf Support Bracket Installation

### Installing the Perforated Shelves





- [1] Rear Pull-out Stop
- [2] Tilt Protection Device
- [3] Front Pull-out Stop
- [4] Shelf

Figure 5-8 Perforated Shelf

1. Push the shelf [4] onto the shelf support brackets with the tilt protection devices [2] facing the rear panel of the refrigerated incubator.

2. Slightly raise the perforated shelf so that the pull-out stops [1] and [3] can slide over the shelf support brackets.
3. Make sure that the shelves and both of their tilt protection devices are free to move over the shelf support brackets.

## Mains connection

	<p> <b>DANGER</b> Electric shock</p> <p><b>Contact with live electrical components may cause a lethal electric shock.</b></p> <p><b>Before connecting the refrigerated incubator to the power supply, check the power cord and the plug for damage. Do not use damaged cables for connecting the refrigerated incubator to the power supply!</b></p>
---	---

The refrigerated incubator has a class I, protection-earthed enclosure. To minimize the risk of electrical shock, use the AC power cord supplied to connect the refrigerated incubator to a correctly installed and protection-earthed power supply source, with the following features in place for each refrigerated incubator:

- T 16 A slow-blow fusing
- B 16 circuit breaker
- FI circuit breaker
- For 400L units only: Maximum permissible system impedance (according to EN/IEC 61000-3-11 clause 6.2.2)  $Z_{max} = 0,432 \text{ Ohm}$ .

## Connecting to the Power Supply Source

1. Before connecting the refrigerated incubator to the power source, check to see if the power supply voltage corresponds with the specifications on the nameplate on the front of the refrigerated incubator. If the voltage (V) and current (A) ratings given are not as required, do not connect the refrigerated incubator to the power source!
2. Connect the IEC connector to the socket at the rear of the refrigerated incubator.
3. Route the power cord along a path that does not cross possible hot surfaces (e.g. exhaust air piping, peltier elements at the equipment rear side) tables, passageways and aisles. With stacked devices, keep the power cord away from hot spots on the other refrigerated incubator in the stack.
4. Connect the protection-earthed plug of the power cord to a correctly protection-earthed and earth leakage circuit breaker fused power socket.
5. Make sure the power cord is not subjected to tensile or compressive force.

	<b>NOTE</b>	<b>Keep the power outlet accessible!</b>
<p>To allow a rapid disconnection of power in case of an emergency, make sure that power outlets remain freely accessible at all times!</p>		



Figure 5-9 AC Power Supply Socket

	<b>NOTE</b>	<b>Condensation</b>
<p>When taking the refrigerated incubator into operation for the first time allow some time before switching on for stabilization to avoid condensation forming on live parts.</p> <p>If a high-voltage test is to be performed on the unit, it must first be heated for around 30 minutes at 50°C.</p>		

## Connecting the RS-232 Interface

	<b>NOTE</b>	
<p><b>Connecting the incubator via RS232 to a computer should only be carried out by skilled and authorized qualified personnel of electrotechnology/signal engineering!</b></p>		

The RS-232 data communication interface supports the querying of status information and temperature data from the refrigerated incubator by entering basic commands in a standard terminal window provided by your computer's operating system. The interconnection requires a standard RS-232 cable with 9-pin connectors and a straight "1:1" pinout without any crossed wires, which is not supplied with the refrigerated incubator.



Users may employ the RS-232 command inventory listed in [table 5-1](#) below for automating process data logging - for example, by embedding these commands in scripts that run on a remote computer.

	<div style="border: 1px solid black; padding: 5px;"> <b>CAUTION</b> <b>RS-232 interface compatibility</b></div> <p>To avoid overloading and damaging the RS-232 interface check the interfacing parameters against the pin-out description given above and make sure that computer's interface port works with a signal level of +/- 5V DC.</p>
--	--

## Interconnecting the refrigerated incubator with a Computer

1. Turn the computer off.
2. Route the serial interface cable along a path that does not cross hot exhaust air piping, Peltier elements, stacked devices, tables, aisles or passageways.  
With stacked devices, keep the serial interface cable away from hot spots on the other refrigerated incubator in the stack.
3. Connect one connector of the serial interface cable (cable length, 5 to max. 10 m, not supplied as a standard item) to the socket labeled RS 223 in the computer and alarm interface section at the rear of the refrigerated incubator (see [“Signal Interfaces and Power Socket”](#) on [page 4-13](#)).
4. Connect the second connector to an unused COM 1 /COM 2 or other serial port on the computer.
5. Boot the computer.
6. Launch your standard terminal program and set up the connection with the following parameters:
  - 57600 bits per second
  - 8 data bits
  - 1 stop bit
  - No Parity
7. Once your terminal indicates that serial communication has been established successfully, enter any of the commands listed in [table 5-1](#) below, depending on what type of information you want to query.
8. Use the following generic command syntax:  
**?:aaa:bb::cc<CR>** , where:
  - **?:** identifies the command line as a query;
  - **aaa:** is the parameter address;

- **bb::** is a query, that must be left at „00” for technical reasons;
- **cc** is for a command - specific checksum listed in the table below.
- **<CR>** is for carriage return.

You will receive a response of the following general format:

**!:aaaa:bb:XXXXX:cc<CR>** , where:

- **!** identifies the line as a response to a query;
- **aaaa**: is the parameter address entered with the query;
- **bb**: is the number of payload bytes in hexadecimal code— for example, **1F** for the decimal value **31**;
- **XXXXXX**: is the significant status information queried;
- **cc**: is a check sum (technically an inverted XOR of all bytes returned, excluding the check sum bytes and the **<CR>** character);
- **<CR>** is for carriage return.

**Table 5-1 Terminal Commands for Querying Data**

Command Syntax	Response Example
<b>Combined Date and Time</b>	
?:0010:00::c1	!:0010:11: <b>31.07.10;01:02:23</b> :e2 Date Time
<b>Date only</b>	
?:0011:00::c0	!:0011:08: <b>31.07.10</b> :d2 Date
<b>Time only</b>	
?:0012:00::c3	!:0012:08: <b>01:02:23</b> :dc Time
<b>Temperature Set Value (T1); Current Work Space Temperature (T2); Reference Temperature (T3); Sample Sensor Temperature (T4)</b>	
?:3010:00::c2	!:3010:1f:+125.00;+124.96;+000.000;+000.00:b0 T1 T2 T3 T4

## Wiring the Alarm Contact

		<p><b>Skilled work</b></p> <p>Thermo Scientific warrants the operational safety and the operativeness of the refrigerated incubator only if installation and repairs are performed by skilled personnel.</p> <p>The connection of the refrigerated incubator to an external alarm system must only be carried out by adequately trained and authorized electrical engineering or telecommunications expert personnel!</p>
--	---	---

## Functional Description

When system errors and failures occur in the temperature control circuits, an alarm message is issued to the connected alarm monitoring system. The potential-free contact (single changeover-type contact) has been designed for the circuit configuration specified below.

		<p><b>Switching behavior</b></p> <p>The alarm relay is energized by all error conditions reported by internal control loops.</p>
--	---	--

## Alarm Relay Specifications

Circuit	Voltage	External fusing
Circuits with system voltage	max. 250 V ~	max. 2 A
SELV circuits (cf. VDE 0100, Part 410)	25 V ~	max. 2 A
	60 V =	max. 1 A
SELV-E circuits (cf. VDE 0100, Part 410)	50 V ~	max. 1 A
	120 V =	max. 0.5 A

		<p><b>Alarm contact electrical compatibility considerations</b></p> <p>To avoid overloading and damaging the alarm contact, check the electrical interfacing parameters of the alarm-receiving system for compatibility with the alarm relay specifications given above.</p>
--	---	--

## Connection Example

The connector [5] for the interface cable is supplied with the refrigerated incubator as a standard item. Specifications for the operating voltage and the fusing of external alarm circuitry are given in the table above.

1. Wire the individual conductors [1] through [4] of the interface cable as shown in the wiring diagram.
2. Route the alarm cable along a path that does not cross possible hot surfaces (e.g. exhaust air piping, peltier elements at the equipment rear side) tables, passageways and aisles. . With stacked devices, keep the alarm cable away from hot spots on the other refrigerated incubator in the stack.
3. Plug the alarm system interface cable connector into the interface port [5] in the rear panel of the refrigerated incubator.

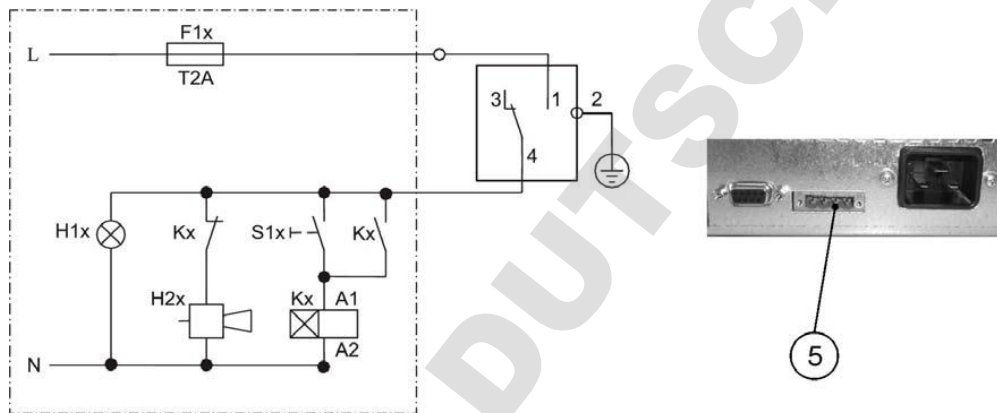

**Figure 5-10 Alarm Contact Connection Example**

The circuit diagram shown above represents the undisturbed condition of operation. In case of an error condition - including a power outage - contact closure occurs on the path between contacts 1-4.

## Operation

### Preparing the refrigerated incubator

The refrigerated incubator must not be released for operation before all major start-up activities have been completed (see “[Installation procedures](#)” on [page 5-1](#)).

#### Device Check

Prior to starting operation, the following refrigerated incubator components must be checked for their correct function:

- The door seal in the front frame must not be damaged.
- The glass door must not be damaged.
- The shelving components must be installed safely.
- Disinfecting the refrigerated incubator’s Work Space

Disinfect the work space according to the operator-specified hygiene guidelines.

### Starting Operation

1. Turn the refrigerated incubator on using the control panel.
2. Adjust the temperature set value on the control panel.
3. The temperature controller starts adjusting the work space to the user-specified temperature set value now.



**DANGER**

To avoid any risk of explosion or fire

- refrain from loading the refrigerated incubator with any of the substances listed in the section “[Incorrect Use](#)” on [page 1-6](#)
- make sure that the ambient air is free of any solvents
- do not operate the refrigerated incubator in areas with an explosion hazard

4. Load the work space with samples.

	<p><b>WARNING</b> Hot surfaces</p> <p>The screen of the glass door, the interior panel of the outer door as well as the surfaces of the shelving and the work space reach temperatures up to 70°C, while the refrigerated incubator is running through its heating cycles and need some time to cool down.</p> <p>When removing samples from a running or recently completed heating cycle, always wear safety gloves and other appropriate personal protection equipment to avoid burns on hot surfaces!</p>
---	---

	<p><b>CAUTION</b> Risk of overloading</p> <p><b>Overloading may damage the shelves or cause the shelves and/or the refrigerated incubator to tilt when the shelves are being drawn out, ultimately destroying the samples. To avoid overloading the refrigerated incubator or its shelving be sure to observe the sample weight limits specified in <a href="#">chapter 13</a>, “<a href="#">Technical Data</a>.”</b></p>
--	---

	<p><b>NOTE</b> Proper loading</p> <p>To ensure sufficient air circulation and uniform heating of the samples, do not use more than 70% of the maximum surface area of the work space. Bulky objects in the work space that dissipate heat may impair heat distribution.</p> <p>During tempering of defined substances or materials with higher moisture content, the access port is to be opened in order to reduce a possible condensation in the chamber. If necessary a modified door seal is available as an accessory,</p>
--	---

## Handling and Control

Heratherm IMP Series refrigerated incubators come with a front panel mounted control unit consisting of a multifunctional display, four control buttons, and an on/off button. The four control buttons interact with the display window to let users access all of the user control functions and adjustments of the refrigerated incubator, including - for example, the temperature set value, timer, energizing/de-energizing an optional AC outlet in the work space, as well as a variety of other functions.

Under normal operating conditions the display presents user with the work space temperature. The display returns to its default mode upon completion of the adjustments or whenever no entries have been made for a period of 30 seconds.



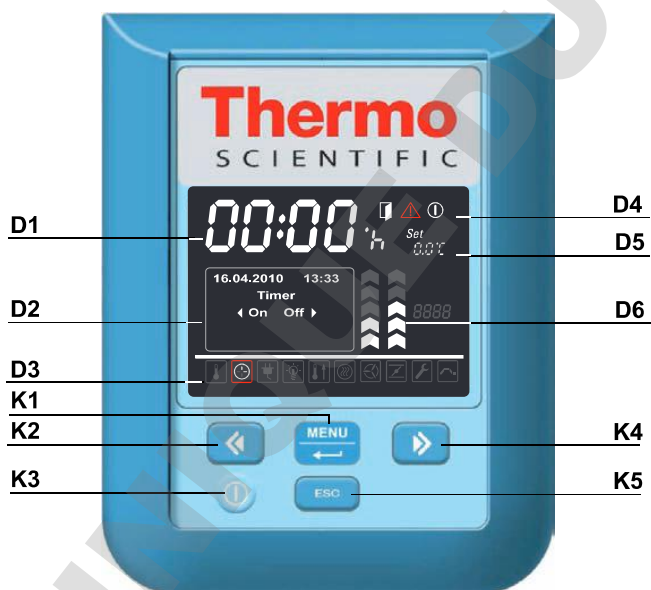

The graphic below shows the Heratherm IMP 180 and IMP 400 control panel with all of its visualization elements and controls.

**Figure 7-1 Control Panel for Heratherm IMP Series refrigerated incubators.**



The table below contains brief descriptions of the buttons on the control panel (items K1 through K5 in [figure 7-1](#)).



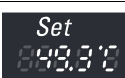

Table 7-1 Control Buttons

Icon	Item	Function
	K1	<p><b>Menu/Enter button</b></p> <p><b>First key press:</b> Activates the menu, highlighting the first menu item with a red border (see D3).</p> <p><b>Second key press:</b> Selects the currently activated menu item (as highlighted by the red border). Depending on the currently selected function, pressing this button enables entries with item D2, D5 or D6.</p> <p><b>Third key press (once a setting has been changed):</b> Confirms a previous entry or selection.</p>
	K2	<p><b>Left button</b></p> <p><b>After the first press of the Menu/Enter button:</b></p> <ul style="list-style-type: none"> <li>- Moves the selection in the menu (see item D3) to the next icon on the left.</li> </ul> <p><b>Once a menu item has been selected:</b></p> <ul style="list-style-type: none"> <li>- Decreases an adjustable parameter value - for example, the temperature set value in D5 or the fan speed level at D6. Holding this button depressed for a few seconds changes the selected value in quick run mode.</li> <li>- Moves the selection in the multifunctional display pane in D2 in the currently activated menu item to the next option on the left - for example, from the <b>Off</b> state of the timer to <b>On</b>.</li> </ul>
	K3	<p><b>On/Off Button</b></p> <p>Holding this button depressed for 2 seconds switches the refrigerated incubator off. The display window goes out, except for the readiness indicator icon in the status display area at item D4. The temperature display field D1 provides a dimmed readout of the work space temperature, provided that the temperature exceeds 50 °C (122 °F).</p>
	K4	<p><b>Right button</b></p> <p><b>After the first press of Menu/Enter button:</b></p> <ul style="list-style-type: none"> <li>- Moves the selection in the menu (see item D3) to the next icon on the right.</li> </ul> <p><b>Once a menu item has been selected:</b></p> <ul style="list-style-type: none"> <li>- Increases an adjustable parameter value - for example, the temperature set value in D5 or the fan speed level at D6. Holding this button depressed for a few seconds changes the selected value in quick run mode.</li> <li>- Moves the selection in the multifunctional display pane in D2 in the currently activated menu item to the next option on the left - for example, from the <b>Off</b> state of the timer to <b>On</b>.</li> </ul>
	K5	<p><b>Escape button</b></p> <p>Returns to the previous level of the menu or standard display. Upon exiting from the current menu item the user may be prompted to save any previously made settings.</p>

The table below contains brief descriptions of the display features of the control panel (items D1 through D6 in [figure 7-1](#); the identifiers K1 through K4 refer to the buttons shown in that figure).



Table 7-2 Display Features

Feature	Item	Function
	D1	Display field showing a permanent readout of the actual temperature in the work space either in °C or °F (depending on the user's preferences, see <a href="#">“Temperature Display Unit”</a> on <a href="#">page 7-20</a> ). The temperature readout has one digit after the decimal point. Alternatively, a flashing time entry prompt of the general format <b>hh:mm</b> (hours:minutes, both with two digits) appears in this place while the user is setting the refrigerated incubator's built-in clock.
	D2	Four-line multifunctional display pane with fields for date and time, a display area for the specific options of the selected menu item, alarm codes, progress indicators for continuous processes (for example, program-controlled temperature ramping), etc.
	D3	Menu bar with iconized representations of adjustable parameters. A red border is used to highlight the current menu item, as selected using the <b>Menu</b> (K1) and arrow buttons <b>Left</b> (K2) and <b>Right</b> (K4). Brief descriptions of the individual menu items are given in <a href="#">table 7-3</a> below. <b>Note</b> If a menu item cannot be selected, then the function it represents is not part of the equipment configuration of your unit.
	D5	Settings pane labeled <b>Set</b> for temperature set value in either °C or °F (depending on the user's preferences; see <a href="#">“Temperature Display Unit”</a> on <a href="#">page 7-20</a> ).
	D6	The left one of the two vertical bar graphs belongs to the <b>Fan</b> icon directly beneath it and displays the current fan speed level.  The fan speed is set to 100% (chevrons 1 through 5 illuminated) and is not adjustable within the IMP series.

The table below contains brief descriptions of the menu bar icons (item D3 in [figure 7-1](#)).

Table 7-3 Menu Bar Icons





Icon	Function
	<b>Temperature Set Value</b> Allows for changing the temperature set value (factory-preset to 37 °C/99 °F) within the permissible temperature range. The set value can be changed by pressing the <b>Left</b> and <b>Right</b> (item K2 or K4) and you can, after confirming your changes with the <b>Menu/Enter</b> button (item K1), track the impact on the actual temperature in the temperature display field at D1. <b>Instructions:</b> <a href="#">“Temperature Set Value”</a> on <a href="#">page 7-5</a> .

Table 7-3 Menu Bar Icons

Icon	Function
	<p><b>Timer</b> Allows for having the refrigerated incubator turn on or off upon expiry of a user-specified countdown period or at a fixed on or off time, or having it operate on a complete weekly schedule of daily on and off times. When the user enables an “on timer” the display goes out. A rotating hand in the <b>Timer</b> icon and the illuminated readiness indicator icon in the status display area indicates that the timer is running. <b>Instructions:</b> “<a href="#">Timer</a>” on <a href="#">page 7-6</a>.</p>
	<p><b>Power Outlet (optional)</b> Toggles the AC outlet in the work space of the refrigerated incubator on and off. <b>Instructions:</b> “<a href="#">Power Outlet (optional)</a>” on <a href="#">page 7-13</a>.</p>
	<p><b>Fan</b> Shows function status of the fan.</p>
	<p><b>Settings</b> Invokes a submenu with the following functions: - Read access to error log - Calibrating the refrigerated incubator - Setting date and time - Toggling the temperature display unit between °C and °F - Selecting the timer mode of operation (countdown / fixed time of day / weekday timer) - Entering a configuration control code - Setting over temperature cut-out according to DIN 12880 (TWB - Temperature selection limiter) <b>(Instructions:</b> “<a href="#">Settings</a>” on <a href="#">page 7-14</a>)</p>

## Powering Up

1. Plug the power plug of the refrigerated incubator into a suitable protection-earthed AC power outlet.



In the display window on the front panel the readiness indicator icon (rightmost icon in the status display area at D4 in [figure 7-1](#) on [page 7-1](#)) is illuminated.



2. Keep the **On/Off** button depressed for two seconds.

An initialization routine will be run after the refrigerated incubator has been powered up. On completion of the initialization, the display will light up and the current work space temperature will appear in the temperature display field (item D1 in [figure 7-1](#) on [page 7-1](#)). The refrigerated incubator is ready for use now.

## Switching the refrigerated incubator Off / Powering Down



1. Keep the **On/Off** button depressed for two seconds.



The display window goes out, except for the readiness indicator icon (rightmost icon in the status display area at D4 in [figure 7-1](#) on [page 7-1](#)) and a residual heat temperature readout in case the work space temperature is still higher than 50 °C (122 °F). The refrigerated incubator is switched off now.









2. If required, unplug the AC power plug to power down the refrigerated incubator completely.

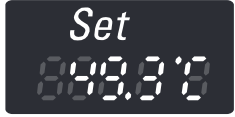

## Temperature Set Value

Heratherm refrigerated incubators allow for setting the desired work space temperature directly using only a few button presses. After confirming the new temperature set value in the settings pane **Set** (item D5 in [figure 7-1](#) on [page 7-1](#)), the user may trace the resulting temperature change in the temperature display field (item D1 in [figure 7-1](#) on [page 7-1](#)).

**Table 7-4 Adjusting the Temperature Set Value**

	<p>Press  to activate the menu bar, then use  to select the <b>Temperature</b> icon and press  to confirm.</p>
	<p>In the flashing settings pane <b>Set</b>, press  or  to adjust a new temperature set value, then press  to confirm your settings.</p>
	<p>The display returns to its default mode. The actual temperature measured in the work space and shown in the temperature display area starts to change until it reaches the newly adjusted set value.</p>



## Timer

The **Timer** feature from the menu bar enables the user to turn the refrigerated incubator on and off at scheduled times. The timer supports three different modes of operation, depending on the user's preferences:











- **Countdown-type on or off timer:** Turns the refrigerated incubator on or off after a user-specified period of time. Instructions on setting the preferences for this option are given in [table 7-5](#), while its use as an off timer and on timer are described in [table 7-6](#) on [page 7-7](#) and [table 7-7](#) on [page 7-7](#), respectively.
- **Fixed-time on or off timer:** Turns the refrigerated incubator on or off at a scheduled time. Instructions on setting the preferences for this option are given in [table 7-8](#) on [page 7-8](#), while its use as an off timer and on timer are described in [table 7-9](#) on [page 7-8](#) and [table 7-10](#) on [page 7-8](#), respectively.
- **Weekly timer:** Turns the refrigerated incubator on or off at scheduled times on specific days of the week. The process for setting the preferences for this option is described in [table 7-11](#) on [page 7-9](#), while instructions for programming the daily turn-on and turn-off times are given in [table 7-12](#) on [page 7-9](#).

Programming a turn-on time causes the refrigerated incubator to switch off until it is scheduled to restart, while a turn-off time keeps the device running before it shuts down at the user-specified time. The timer starts running immediately as soon as the user confirms his or her entries.

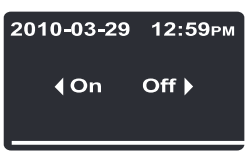

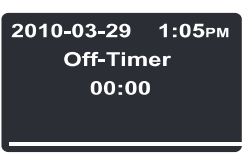

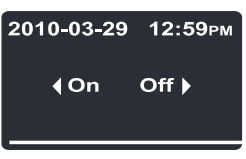

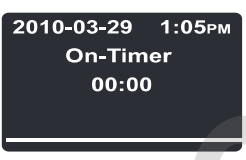



**Table 7-5 Presetting the Countdown Timer Mode of Operation**

	Press  to activate the menu bar, then use  to select the <b>Settings</b> icon and press  to confirm.
	Press  to switch to the <b>Timer</b> menu item and confirm the selection with .
	Press  or  to select the <b>Count Down</b> timer mode of operation, then use  to confirm the selection.
	The display returns to its default mode.

**Table 7-6 Setting a Countdown-type off Timer**

	<p>Press  to activate the menu bar, then use  to select the <b>Timer</b> icon and press  to confirm.</p>
	<p>Press  to select the off timer option <b>Off</b>.</p>
	<p>Set the hours and minutes until the refrigerated incubator is supposed to shut down by pressing  or , then press  to confirm.</p>
	<p>The display returns to its default mode. In the menu bar, the Timer icon is illuminated and a hand is rotating on the icon's face.</p>

**Table 7-7 Setting a Countdown-type On Timer**

	<p>Press  to activate the menu bar, then use  to select the <b>Timer</b> icon and press  to confirm.</p>
	<p>Press  to select the on timer option <b>On</b>, then  to confirm.</p>
	<p>Set the hours and minutes until the refrigerated incubator is supposed to turn on by pressing  or , then press  to confirm.</p>
	<p>The refrigerated incubator switches off. The display goes out, the Timer icon is illuminated in the menu bar with a rotating hand on its face. Additionally, the readiness indicator icon is illuminated.</p>

## Setting a Fixed-time On or Off Timer

Table 7-8 Presetting the “Fixed-time” Timer Mode of Operation











	<p>Press  to activate the menu bar, then use  to select the <b>Settings</b> icon and press  to confirm.</p>
	<p>Press  to switch to the <b>Timer</b> menu item and confirm the selection with .</p>
	<p>Press  or  to select the <b>Absolute</b> fixed-time timer mode of operation, then  to confirm the selection.</p>
	<p>The display returns to its default mode.</p>

Table 7-9 Setting a Fixed-time Off Timer



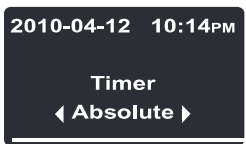







	<p>Press  to activate the menu bar, then use  to select the <b>Timer</b> icon and press  to confirm.</p>
	<p>Press  to select the off timer option <b>Off</b>.</p>
	<p>Set year, month, day, hours and minutes using  or , followed by  to confirm.</p>
	<p>In the menu bar, the Timer icon is illuminated and a hand is rotating on the icon's face.</p>

Table 7-10 Setting a Fixed-time On Timer



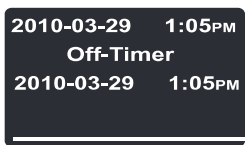







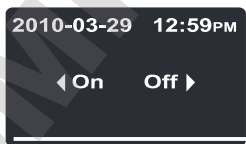

	<p>Press  to activate the menu bar, then use  to select the <b>Timer</b> icon and press  to confirm.</p>
	<p>Press  to select the on timer option <b>On</b>, then  to confirm.</p>

Table 7-10 Setting a Fixed-time On Timer

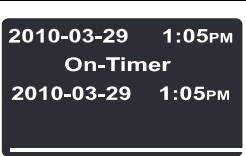
	<p>Set year, month, day, hours and minutes using  or , followed by  to confirm.</p>
 	<p>The refrigerated incubator switches off. The display goes out, the Timer icon is illuminated in the menu bar with a rotating hand on its face, and the readiness indicator icon is illuminated additionally.</p>

## Setting a Weekly Timer

Table 7-11 Presetting the Weekly Timer Mode of Operation











	<p>Press  to activate the menu bar, then use  to select the <b>Settings</b> icon and press  to confirm.</p>
	<p>Press  to switch to the <b>Timer</b> menu item and confirm the selection with .</p>
	<p>Press  or  to select the <b>Weekly</b> timer mode of operation, then  to confirm the selection.</p>
	<p>The display returns to its default mode.</p>

Table 7-12 Setting a Weekly Timer



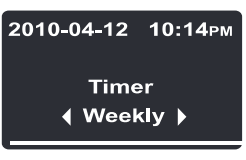











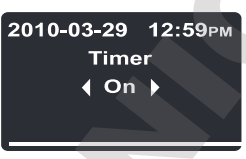

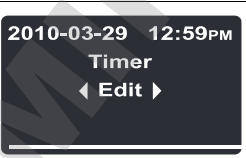

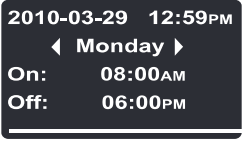









	<p>Press  to activate the menu bar, then use  to select the <b>Timer</b> icon and press  to confirm.</p>
	<p>In the selection screen shown at left, press  to switch from the default <b>On</b> to the <b>Edit</b> option.</p>
	<p>Select the <b>Edit</b> option by pressing .</p>

Table 7-12 Setting a Weekly Timer

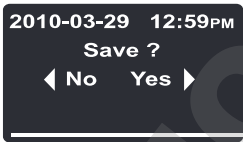
	<p>Press  to select the turn-on time for Monday, which should start flashing when selected (or continue to the desired weekday by pressing , which will cause the turn-on time of that day to start flashing).</p> <p>Press  or  to set the hours, then continue to minutes by pressing .</p> <p>Use  or  to set the minutes, then continue to the turn-off time by pressing .</p> <p>Set the turn-off time as explained above, then press  to continue to Tuesday or any other desired weekday.</p> <p>To prevent the refrigerated incubator from turning on and back off on a specific day, set both hours and minutes to --:--.</p>
	<p>Set the scheduled turn-on and turn-off times for each single day of the week all the way to Sunday and press . (The turn-on and turn-off times for Saturday and Sunday are disabled by default.)</p> <p>If there is no need to set the turn-on and/or turn-off times for a specific weekday, press  and  or  to go back and forth to the previous and next day, respectively.</p>
	<p>When prompted to save your changes, press  to confirm.</p> <p><b>Note</b> This prompt for saving also appears when you press the <b>Esc</b> button while working on the weekly timer's settings.</p>
	<p>To enable the weekly timer press .</p> <p>Alternatively, press  and  to select the <b>Off</b> option if the weekly timer you have just saved should be activated at a later date.</p>
	<p>In the menu bar, the Timer icon is illuminated and a hand is rotating on the icon's face.</p>



## Stopping a Timer

Table 7-13 Stopping an Off Timer Before It Expires









	<p>Press  to activate the menu bar, then use  to select the <b>Timer</b> icon and press  to confirm.</p>
	<p>Press  to confirm the <b>Yes</b> default selection.</p>
	<p>The message <b>Timer stopped!</b> appears as a confirmation.</p>
	<p>The display will return to the main menu. In the menu bar, the Timer icon will go out.</p>

Table 7-14 Stopping an On Timer Before it Expires



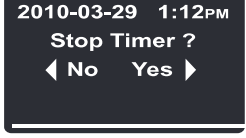

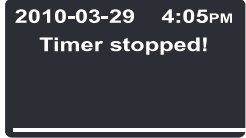





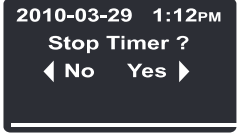

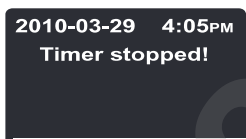
	<p>To cancel a pre-programmed on timer while the refrigerated incubator is switched off, hold the On/Off button depressed for a few seconds.</p>
	<p>In the <b>Stop Timer?</b> prompt that appears, confirm the default selection <b>Yes</b> by pressing .</p>
	<p>The message <b>Timer stopped!</b> appears as a confirmation.</p>
	<p>The display will return to the main menu. In the menu bar, the Timer icon will go out.</p>

Table 7-15 Stopping a Weekly Timer Before It Expires

	<p>Press  to activate the menu bar, then use  to select the <b>Timer</b> icon and press  to confirm.</p>
 <p style="text-align: center;">↓</p> 	<p>The flashing word <b>On</b> appears in the multifunctional display pane.</p> <p>Press  to switch to <b>Off</b> state, then press  to confirm.</p>
	<p>The message <b>Timer stopped!</b> appears as a confirmation.</p>
	<p>In the menu bar, the Timer icon will go out. The display returns to the entry screen for the current type of timer.</p>

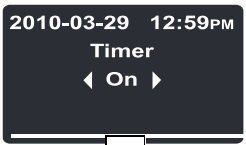
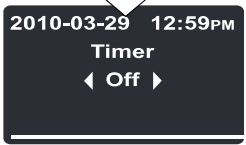
	<div style="background-color: #0056b3; color: white; padding: 5px; display: inline-block;"><b>NOTE</b></div>	<p><b>Stopping the timer</b></p> <p>After stopping the timer, no return to the standard display follows, instead to the level the timer is restarted,</p>
--	--	---

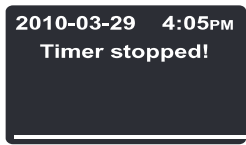

## Power Outlet (optional)

This menu item toggles the built-in AC outlet in the work space of the refrigerated incubator on and off. While the outlet is in live state the **Power Outlet** icon is illuminated in the menu bar.

**Table 7-16 Turning the AC Outlet On**

	<p>Press  to activate the menu bar, then use  to select the <b>Power Outlet</b> icon and press  to confirm.</p>
	<p>In the selection screen that appears, press  or  to switch to the <b>On</b> option and confirm the selected <b>On</b> option by pressing .</p>
	<p>The selected option <b>On</b> remains in the display pane for a few seconds to let you track your action.</p>
	<p>The display returns to its default mode. The <b>AC Outlet</b> icon in the menu bar is illuminated to indicate that the outlet is live.</p>

**Table 7-17 Turning the AC outlet off**

	<p>Press  to activate the menu bar, then use  to select the <b>Power Outlet</b> icon and press  to confirm.</p>
	<p>In the selection screen that appears, press  or  to switch to the <b>Off</b> option and confirm the selected <b>Off</b> option by pressing .</p>
	<p>The selected option <b>Off</b> remains in the display pane for a few seconds to let you track your action.</p>
	<p>The display returns to its default mode. The <b>AC Outlet</b> icon in the menu bar is extinguished to indicate that the outlet is switched off.</p>



## Fan

The fan is set to 100% (5 chevrons illuminated) and not adjustable. The current setting of the fan is indicated by the illuminated **Fan** icon in the menu bar and the five-level bar graph (see item D6 in [figure 7-1](#) on [page 7-1](#)) for the fan speed setting located directly above the icon.



## Settings

The **Settings** menu item opens a submenu populated with various commands for viewing general status information on the Heratherm unit and setting for the operation of the refrigerated incubator or its display window:

- Read access to error log
- Calibrating the refrigerated incubator
- Setting date and time
- Toggling the temperature display unit between °C and °F
- Entering a configuration control code
- Setting over temperature cut-out according to DIN 12880 class 2 (TWB - Temperature selection limiter).











Instructions for using these features are given in the following. Also supported is an option for presetting the timer mode of operation, as explained previously in the section “[Timer](#)” on [page 7-6](#).

## Error Log

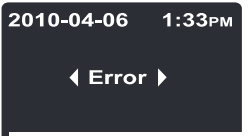
Users calling customer service for support may be asked by the Thermo Fisher Scientific agent to supply information from the error log of the refrigerated incubator. This internal memory may be accessed by choosing the **Settings** -> **Error** menu item. It enables the user to browse through the most recent 22 alarm messages that were caused by hardware or control loop errors. Each error is displayed with the date and time of its occurrence, a brief clear text description and an internal error code.

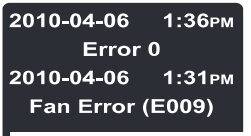
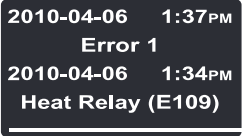
Error codes and instructions for clearing alarm conditions appear in the section “[Error Codes](#)” on [page 12-1](#).

Table 7-18 Reading the Error Log

	<p>Press  to activate the menu bar, then use  or  to select the <b>Settings</b> icon and press  to confirm.</p>
	<p>Press  to select the <b>Error</b> item from the <b>Settings</b> submenu.</p>
	<p>The first entry of the error log is displayed, named "<b>Error 0.</b>"</p>
	<p>Press  to go to the next entry (or  to go back to the previous one). After the entry numbered 21 the display wraps and returns to the beginning of the error log, displaying <b>Error 0</b> again.</p>
	<p>To exit from the error log and return to normal display mode press  twice. The <b>Settings</b> icon in the menu bar will go out.</p>











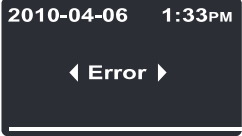
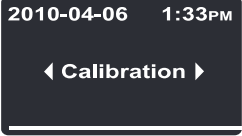

## Calibration

The **Settings** -> **Calibration** menu item enables the user to initiate a temperature calibration process (see "[Temperature Calibration Procedure](#)" on page 10-4) for the built-in temperature sensors and choose whether calibration should be accomplished manually or automatically:

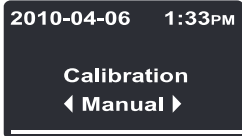
- The **Manual** option allows for entering an absolute temperature directly, as measured - for example, using an external reference sensor.

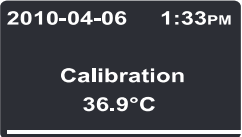
	<p><b>Calibration Prerequisites</b></p>
<p>Maintain the ambient conditions within the specified limits of the refrigerated incubator before launching calibration.</p>	
<p>Varying ambient conditions may impact the result of the calibration routine, which may lead to mis-adjustment of the controller and unreliable temperature control operation.</p>	
<p>In individual cases, the display may differ from the actual temperature value and can be corrected by using the function calibration.</p>	

**Table 7-19 Entering the Calibration Reference Temperature Manually**

	Prepare for temperature calibration (see “Preparing Temperature Calibration” and “Comparison Measurement Procedure” on page 10-3).
	Press  to activate the menu bar, then use  or  to select the <b>Settings</b> icon and press  to confirm.
	The <b>Error</b> menu item from the <b>Settings</b> submenu appears in the multifunctional display pane.
	Press  to switch to the <b>Calibration</b> menu item and confirm the selection with  .
	In the <b>Calibration</b> selection screen, press  to choose the preselected option <b>Manual</b> .
	In the settings dialog that appears, set the temperature measured with the external reference sensor by using  or  and confirm the settings with  .
	The newly entered value will be stored and used to calibrate the internal temperature sensors with the value measured by the reference sensor. The display returns to its default mode. The <b>Settings</b> icon in the menu bar will go out.

## Date and Time

The **Settings** -> **Time / Date** option allows for switching between the international time and date display formats and for setting the time and date of the internal clock. There are two display formats to choose from:

- European date format *DD.MM.YYYY* and 24-hours time format. Example: *07.04.2010* and *15:05*.
- US standard date format *YYYY-MM-DD* and 12-hour time format with *AM/PM* suffix. Example: *2010-04-07* and *3:05 PM*.

Table 7-20 Setting the Date Format

	<p>Press  to activate the menu bar, then use  or  to select the <b>Settings</b> icon and press  to confirm.</p>
	<p>The <b>Error</b> menu item from the <b>Settings</b> submenu appears in the multifunctional display pane.</p>
	<p>Press  to switch to the <b>Time / Date</b> menu item and confirm the selection with .</p>
	<p>The <b>Format Date</b> menu item is flashing in the multifunctional display pane. Choose the preselected option <b>Format Date</b> by pressing .</p> <p>The date field will start flashing in the upper left corner of the multifunctional display pane.</p>
	<p>Press  or  to switch to the desired date format <b>DD.MM.YYYY</b> or <b>YYYY-MM-DD</b> and confirm the selection with .</p> <p>The date field in the upper left corner will change its appearance according to your selection (and stop flashing).</p>
	<p>The display returns to its default mode. The <b>Settings</b> icon in the menu bar will go out.</p>

Table 7-21 Setting the Time Format



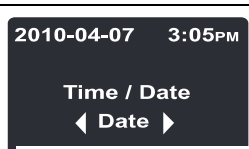

	<p>Press  to activate the menu bar, then use  or  to select the <b>Settings</b> icon and press  to confirm.</p>
	<p>The <b>Error</b> menu item from the <b>Settings</b> submenu appears in the multifunctional display pane.</p>

Table 7-21 Setting the Time Format







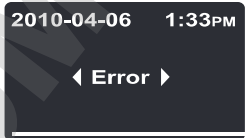

	<p>Press  to switch to the <b>Time / Date</b> menu item and confirm the selection with .</p>
	<p>The <b>Format Date</b> menu item is flashing in the multifunctional display pane.</p>
	<p>In the flashing <b>Format Date</b> menu item, press  to switch to the <b>Format Time</b> option and confirm the selection with .</p> <p>The <b>Format Date</b> menu item is flashing in the multifunctional display pane, along with the time field in the upper right corner.</p>
	<p>Press  or  to switch to the desired time format <b>hh:mm</b> or <b>hh:mm AM/PM</b> and confirm the selection with .</p> <p>The time field in the upper right corner will change its appearance according to your selection (and stop flashing).</p>
	<p>The display returns to its default mode. The <b>Settings</b> icon in the menu bar will go out.</p>

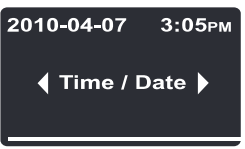
Table 7-22 Setting Date and Time

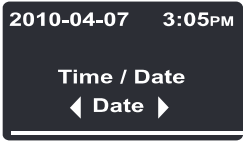
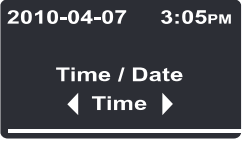

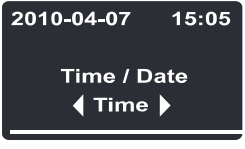











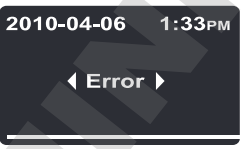
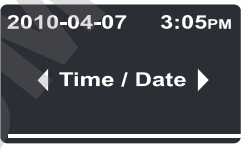

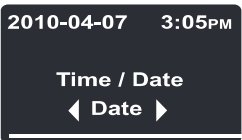
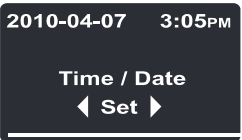

	<p>Press  to activate the menu bar, then use  or  to select the <b>Settings</b> icon and press  to confirm.</p>
	<p>The <b>Error</b> menu item from the <b>Settings</b> submenu appears in the multifunctional display pane.</p>
	<p>Press  to switch to the <b>Time / Date</b> menu item and confirm the selection with .</p>



Table 7-22 Setting Date and Time

	<p>The <b>Format Date</b> menu item is flashing in the multifunctional display pane.</p>
	<p>From the flashing <b>Format Date</b> menu item, press  to switch to the <b>Adjust</b> option and confirm the selection with . The <b>Adjust</b> menu item is flashing in the multifunctional display pane now, along with the day or year section (depending on the selected date format) of the date field in the upper left corner.</p>
	<p>Press  or  to set the year and confirm your settings with . The flashing selection moves on to the month section of the date field. Set months, days (or years), hours and minutes using  or  and confirm each setting with .</p>
	<p>When you confirm with the  button after setting the minutes, the date and time field in the upper right corner will be updated according to your settings (and stop flashing). The display returns to its default mode. The <b>Settings</b> icon in the menu bar will go out.</p>

## Temperature Display Unit

The **Settings** -> °C / °F menu item allows for toggling the refrigerated incubator used for displaying temperatures between degrees Centigrade and Fahrenheit.







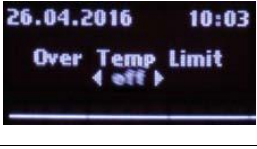

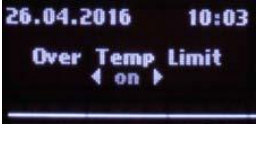



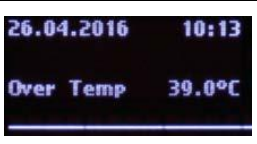

**Table 7-23 Toggling the Temperature Display Unit**

	<p>Press  to activate the menu bar, then use  or  to select the <b>Settings</b> icon and press  to confirm.</p>
	<p>The <b>Error</b> menu item from the <b>Settings</b> submenu appears in the multi-functional display pane.</p>
	<p>Press  to switch to the °C / °F menu item and confirm the selection with .</p>
  <p style="text-align: center;">↕</p>	<p>The multi-functional display pane changes to the following selection screen, with the currently unused temperature display unit (factory setting is °C) flashing. Confirm the selection with .</p>
	<p>The temperatures in the display field (item D1 in <a href="#">figure 7-1</a> on <a href="#">page 7-1</a>) and settings pane <b>Set</b> (item D5 in the same figure) will be displayed with the newly selected unit.</p> <p>The display returns to its default mode.</p> <p>The <b>Settings</b> icon in the menu bar will go out.</p>

## TWB Setting/Activating

With menu point **Settings** -> **Over Temp** the TWB (adjustable temperature selection limiter) of the refrigerated incubator can be set, according to DIN 12880 class 2.

**Tabelle 7-24 Setting the over temperature cut-out**

	<p>Press  to activate the menu bar, then use  or  to select the <b>Settings</b> icon and press  to confirm.</p>
	<p>Press  to invoke menu point <b>Over Temp Limit</b> of the sub menu <b>Settings</b>.</p>
	<p>Press  to change to <b>on</b> and press  to confirm.</p>
	<p>Press  or  to select the Set Temperatur, e.g. 39 °C  . Press  to confirm the selection.</p>
	<p>Pressing  the display returns to the standard display with activated <b>Over Temp</b>. The <b>Settings</b> icon in the menu bar will go out.</p>

	<div style="border: 1px solid black; padding: 5px;"> <p style="text-align: center;"><b>NOTE</b></p> <p><b>Set temperature of the Over Temp</b></p> <p>In the unlikely event that the temperature in the chamber surpasses the set temperature of the Over Temp, the unit will switch off the Peltier element. The operator needs to re-activate the unit by pressing</p> </div>
--	---









## Program Preferences

The **Settings** ->**Program** menu item supports the preferences described in the following for the execution of user programs (see “Programming” on page 7-37) used to control the operations. When a program terminates after running through one or more program cycles (see the section “Program Cycle Prompt” below), a single audible signal consisting of 5 beeps is given when no error condition is present. The is then switched off, unless the user has set the preferences to keep it running, as explained in the section “Mode after End (of Program)” on page 7-23.



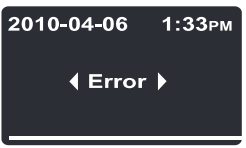
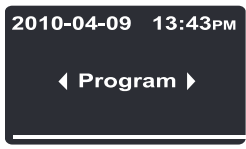

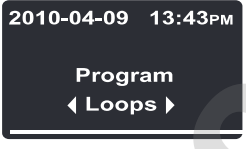

### Program Cycle Prompt

This menu item allows for enabling a prompt (deactivated when the ships from the factory) that asks for the number of times a program should be repeated (see “Launching a Program” on page 7-26) whenever the user launches a program.

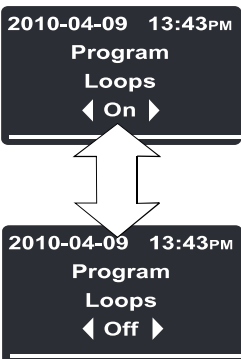
**Table 7-25 Activating / Deactivating the Program Cycle Prompt**

	<p>Press  to activate the menu bar, then use  or  to select the <b>Settings</b> icon and press  to confirm.</p>
	<p>The <b>Error</b> menu item from the <b>Settings</b> submenu appears in the multifunctional display pane.</p>
	<p>Press  to switch to the <b>Program</b> menu item and confirm the selection with .</p>
	<p>In the selection screen that appears, choose the preselected option <b>Loops</b> by pressing .</p>

**Table 7-25 Activating / Deactivating the Program Cycle Prompt**

	<p>In the subsequent selection screen, enable the prompt (deactivated in “as shipped” state) by using  to move the selection from <b>Off</b> to <b>On</b> state.</p> <p>To deactivate the prompt, switch back from <b>On</b> to <b>Off</b> state using  or  and confirm the selection with .</p> <p>When you choose <b>Off</b>, the is switched off after just one program cycle. You may change this default behavior by changing the “<a href="#">Mode after End (of Program)</a>” preference explained in the next section.</p>
	<p>The display returns to its default mode. The <b>Settings</b> icon in the menu bar will go out.</p>

**Mode after End (of Program)**

Additionally this command allows for enabling a second prompt (also deactivated when the refrigerated incubator is shipped from the factory) that appears when the user launches a program and asks for the mode of operation the should continue to run upon completion of the program (see “[Launching a Program](#)” on page 7-26):

- **Off:** This option turns the device off when the program ends. It does not prompt the user to confirm.
- **On:** When the user launches a program, this option prompts whether the should be turned off or continue to run in hold mode with the latest settings until the user acknowledges the end of the program.

An active weekly timer will be suspended until the **Program End** message is acknowledged. Upon resuming the timer, the refrigerated incubator will seek to establish the set value that was in place before the program was started.

**Table 7-26 Changing the Mode after End**





	<p>Press  to activate the menu bar, then use  or  to select the <b>Settings</b> icon and press  to confirm.</p>
	<p>The <b>Error</b> menu item from the <b>Settings</b> submenu appears in the multifunctional display pane.</p>

Table 7-26 Changing the Mode after End







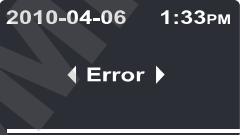





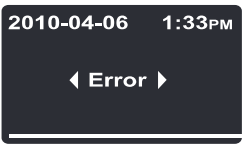
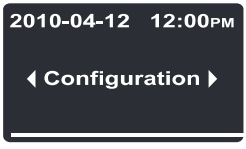

<p>2010-04-09 13:43PM</p> <p>◀ Program ▶</p>	<p>Press  to switch to the <b>Program</b> menu item and confirm the selection with .</p>
<p>2010-04-09 13:43PM</p> <p>Program</p> <p>◀ Loops ▶</p> <p>↓</p> <p>2010-04-09 13:43PM</p> <p>Program</p> <p>◀ Mode after End ▶</p>	<p>In the selection screen that appears press  to switch from the preselected option <b>Loops</b> to <b>Mode after End</b>, then confirm the selection with .</p>
<p>2010-04-09 13:43PM</p> <p>Program</p> <p>Mode after End</p> <p>◀ On ▶</p> <p>↕</p> <p>2010-04-09 13:43PM</p> <p>Program</p> <p>Mode after End</p> <p>◀ Off ▶</p>	<p>In the subsequent selection screen press  or  to switch between the <b>On</b> (Temperature Hold) and <b>Off</b> (factory default) states, then confirm the selection with .</p>
	<p>The display returns to its default mode. The <b>Settings</b> icon in the menu bar will go out.</p>

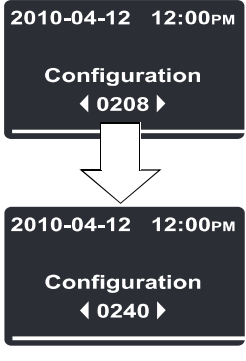
## Configuration

The **Settings** -> **Configuration** menu item enables the user to enter a four-digit code that loads a specific set of operating parameters for the - for example, in order to make the voltage selection described in the section “[Connecting the RS-232 Interface](#)” on [page 5-11](#) (only for 180 liter units).

**Table 7-27 Entering the Four-digit Code**

	<p>Press  to activate the menu bar, then use  or  to select the <b>Settings</b> icon and press  to confirm.</p>
	<p>The <b>Error</b> menu item from the <b>Settings</b> submenu appears in the multifunctional display pane.</p>
	<p>Press  to switch to the <b>Configuration</b> menu item and confirm the selection with .</p>
	<p>The multifunctional display pane will present a prompt similar to the example shown at left, with the first digit of the four-digit configuration code flashing.</p> <p>Set the first digit of the configuration code using  (or ) and confirm your setting with . Set the remaining three digits exactly as described above.</p> <p>By confirming your entry for the last digit with , the new configuration is activated immediately.</p>
	<p>The display returns to its default mode. The <b>Settings</b> icon in the menu bar will go out.</p>

## Programming

The menu item **Program** enables the user to create, store and launch up to 10 programs for automating workflows. Each of the 10 programs may consist of a maximum of 10 steps.

The following properties may be defined for each step, depending on the current hardware configuration:

- duration in hh:mm
- temperature set value











To ease the creation of programs users may choose to copy and edit existing programs.

## End of Program

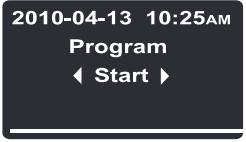
The end of a program is indicated by an audible signal (5 beeps). The refrigerated incubator is switched off or changes to Temperature Hold mode, as preset in the preferences under “[Mode after End \(of Program\)](#)” on [page 7-23](#). The display shows the message **Program End** as well as the temperature of the residual heat.

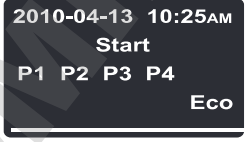







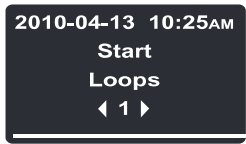

## Instructions

Table 7-28 Launching a Program

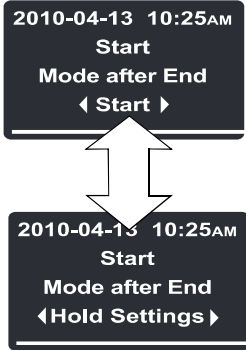
	<p>Press  to activate the menu bar, then use  or  to select the <b>Program</b> icon and press  to confirm.</p>
	<p>In the selection screen shown at left, choose the preselected option <b>Start</b> by pressing .</p>
	<p><b>Stop Timer Prompt Upon Launching a Program</b> When a timer is running, an additional <b>Stop Timer</b> prompt appears at this point (see “<a href="#">Stopping an Off Timer Before It Expires</a>” on <a href="#">page 7-14</a>). Choosing Yes aborts the timer and launches the selected program. Choosing No allows the timer to continue running. However, when a user program and a timer overlap, the program about to launch has priority over the timer, that is, the timer will be put on hold and execute only after the program has finished.</p>
	<p>In the list of existing programs (for example: <b>P1...P4</b>) shown at left, maintain the default selection <b>P1</b> or choose another program using  (or ). In either case, press  to launch the program.</p>

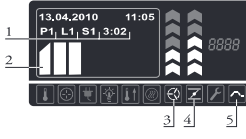

**Table 7-28 Launching a Program**

	<p>If activated in the preferences for programs (see “<a href="#">Activating / Deactivating the Program Cycle Prompt</a>” on page 7-22), the <b>Loops</b> prompt appears, asking for the desired number of program cycles (= Loops).</p> <p>Set the number of cycles by using  or  (default is “1” for one cycle) and confirm with .</p>
	<p>If activated in the preferences for programs (see “<a href="#">Changing the Mode after End</a>” on page 7-23), the <b>Mode after End</b> prompt will appear. You may use this dialog to select the desired mode of operation after a program has finished executing, that is, to have the turn off or go to hold mode when the program ends.</p> <p>Use  or  to choose the desired mode of operation and confirm the selection with .</p>
	<p>The multifunctional display pane presents a progress bar for the selected program, similar to the example shown at left.</p> <p>The functions of the display elements are explained in <a href="#">table 7-30</a> below.</p>
	<p>The <b>Program</b> icon in the menu bar is illuminated to indicate that a user program is running.</p>

The functions of the display elements (save for the date and time fields; see [table 7-2](#) on [page 7-3](#)) are explained in the following table.

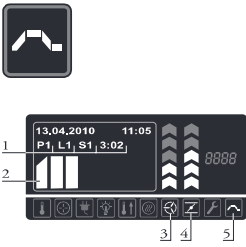

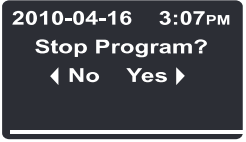



**Table 7-29 Display Elements Active during Program Execution**

No.	Function
1	<p>These three fields show the following program execution information:</p> <ul style="list-style-type: none"> <li>- ID of the active program - for example: <b>P1</b> for Program 1</li> <li>- number of the current program cycle - for example, <b>L1</b> for the first cycle (appears only when the prompt for the number of program cycles is active; see “<a href="#">Activating / Deactivating the Program Cycle Prompt</a>” on <a href="#">page 7-22</a>)</li> <li>- overall remaining time - for example: <b>3:02</b></li> </ul> <p><b>Note</b> The remaining time does not include any phases whose duration has been set to 00:00 in order to achieve rapid heat-up or cool-down of the .</p>
2	<p>This bar graph uses a variable number of bars to represent the progress of program execution: Three bars - for example, indicate step No. 3, four bars step No. 4 of a program, etc. Up to 10 bars may appear in this place, equivalent to a maximum of 10 steps (see above).</p>

**Table 7-29 Display Elements Active during Program Execution**

No.	Function
3	The <b>Fan</b> icon is illuminated to indicate that the fan has been turned on for the current step of the program. The fan speed level can be determined from the bar graph located directly above the icon (see <a href="#">table 7-2</a> on <a href="#">page 7-3</a> ).
4	The <b>Damper</b> icon is illuminated to indicate that the fan damper has been opened for the current step of the program. The damper position can be determined from the bar graph located directly above the icon (see <a href="#">table 7-2</a> on <a href="#">page 7-3</a> ).
5	The <b>Program</b> icon in the menu bar is illuminated to indicate that a user program is running.

**Table 7-30 Aborting a Program**

	<p>While a program is running (as indicated by the flashing bar, program number and remaining time counter in the multifunctional display pane and the <b>Program</b> icon illuminated in the menu bar) press  or .</p>
	<p>When the prompt shown at left appears in the multifunctional display pane, press  to choose the <b>Yes</b> option and confirm the selection with .</p>
	<p>The display returns to its default mode. The <b>Program</b> icon in the menu bar will go out.</p>

**Table 7-31 Creating a New Program**









	<p>Press  to activate the menu bar, then use  or  to select the <b>Program</b> icon and press  to confirm.</p>
	<p>In the selection screen that appears press  to switch from the preselected option <b>Start</b> option to <b>New</b>, then confirm the selection with .</p>

Table 7-31 Creating a New Program









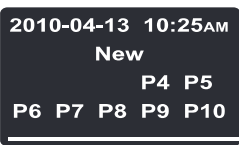

	<p>In the following selection screen, maintain the default selection (for example: <b>P4</b>) or choose any other program from the list of free program memory slots (example at left shows free memory slots at <b>P4...P10</b>) using  (or ).</p> <p>In either case press  to start creating a new program.</p>
	<p>A programming screen appears for the first step of the program, which is represented by a flashing empty bar. If the first step is supposed to last longer than an hour (up to 23 hours are supported), use  to set the hour count for the duration of the first step and confirm your settings with .</p> <p>Then, set the minute count using  (or press to accept zero minutes) and confirm your settings with .</p>
<p><b>NOTE</b></p>	<p><b>Setting the Duration of a Program Step</b></p> <p>By letting the duration of the step default to <b>00:00</b>, the temperature set value is reached as fast as possible. If you enter a time span, the refrigerated incubator will rather try to reach the set value along a continuously rising or falling ramp curve. For each step that involves a temperature change, the ramp is visually represented by a slanted top of the progress bar.</p>
	<p>The selection moves on to the settings pane <b>Set</b>, which will start flashing.</p> <p>Use  to set the desired temperature set value and confirm your settings with .</p> <p><b>Note</b> If you need to set up a program that involves a subsequent cool-down phase, you may want to consider programming the last step with a set temperature value of 0 °C (32 °F) to speed up cool-down. For details and instructions see <a href="#">“Temperature Set Value” on page 7-7</a>.</p>

Table 7-31 Creating a New Program





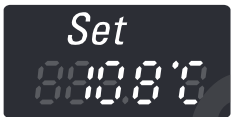





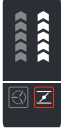

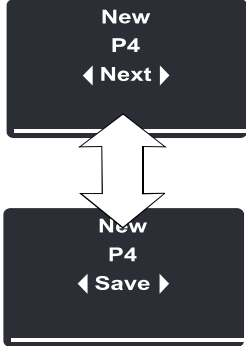





	<p>The selection moves on to the bar graph for the damper, which will start flashing.</p> <p>If you want the damper to remain open for the duration of the current program step, use  to select the desired damper position and confirm your settings with .</p>
	<p>The <b>Next</b> prompt appears in the multifunctional display pane.</p> <p>If you wish to create an additional program step, press the  button.</p> <p>The display returns to the initial stage of program creation. Now, the second bar will be flashing, representing the second program step.</p> <p>If you do not wish to create an additional program step, press  or  to continue to the <b>Save</b> option, then press  one more time to save the newly created program.</p>
	<p>The display returns to its default mode.</p> <p>The newly created program may be launched now, as described in “<a href="#">Launching a Program</a>” on <a href="#">page 7-26</a>.</p>

Table 7-32 Deleting an Existing Program

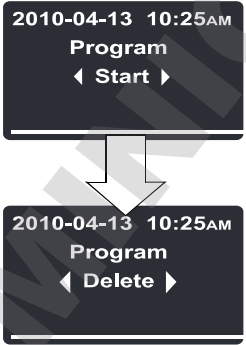
	<p>Press  to activate the menu bar, then use  or  to select the <b>Program</b> icon and press  to confirm.</p>
	<p>In the selection screen shown at left, press  to switch to the <b>Delete</b> option.</p>

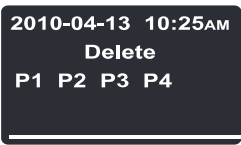
**Table 7-32 Deleting an Existing Program**

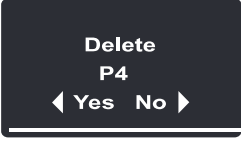
	<p>In the list of existing programs (for example: <b>P1...P4</b>; default selection is <b>P1</b>) shown at left, choose any program by pressing , then press  to confirm the deletion.</p>
	<p>In the confirmation dialog for the deletion that appears, press  to choose the <b>Yes</b> option (default selection is <b>No</b>), then press  to have the deletion carried out.</p>
<p>The display returns to its default mode. The program memory is free to accept a new or copied program (see “<a href="#">Creating a New Program</a>” on page 7-28 and the procedure described below under “<a href="#">Copying an Existing Program</a>”).</p>	

**Table 7-33 Copying an Existing Program**









	<p>Press  to activate the menu bar, then use  or  to select the <b>Program</b> icon and press  to confirm.</p>
	<p>In the selection screen shown at left, press  to switch to the <b>Copy</b> option.</p>
	<p>In the list of existing programs (for example: <b>P1...P4</b>; default selection is <b>P1</b>) shown at left, choose any program by pressing , then press  to start copying.</p>

Table 7-33 Copying an Existing Program

	<p>In the list of free program memory slots in the selection screen that appears (for example: <b>P5...P10</b>) press  to choose a target slot for copying, then press  to confirm the copy target.</p>
	<p>In the confirmation dialog for copying that appears, press  to choose the <b>Yes</b> option (default selection is <b>No</b>), then press  to confirm copying.</p>
	<p>The display returns to its default mode. The program you have just copied to the targeted memory slot may be edited now to adapt it to specific needs (see the procedure described below under <a href="#">“Editing an Existing Program”</a>).</p>

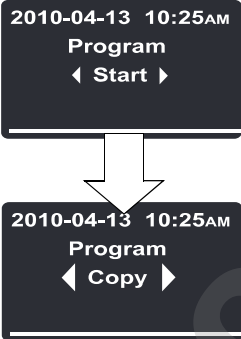
Table 7-34 Editing an Existing Program

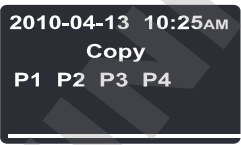
	<p>Press  to activate the menu bar, then use  or  to select the <b>Program</b> icon and press  to confirm.</p>
	<p>In the selection screen shown at left, press  to switch to the <b>Edit</b> option.</p>
	<p>In the list of existing programs (for example: <b>P1...P4</b>; default selection is <b>P1</b>) shown at left, choose the program you wish to edit by pressing , then press  to confirm the selection.</p>

Table 7-34 Editing an Existing Program

	<p>In the programming screen that appears, choose the first program step for editing by pressing  or use  to navigate to another program step and select it by pressing .</p> <p>Edit the duration, temperature set value, fan speed and damper position as explained under “<a href="#">Creating a New Program</a>” on <a href="#">page 7-28</a>.</p> <p>When you are done with the last edit, you may press either  to go to the next program step or  to cycle through all settings for the step you have just edited. If this is the last step, you will be presented with the following prompt for saving your changes.</p>
	<p>When prompted for saving your changes, press  to choose the <b>Yes</b> option (default selection is <b>No</b>), then press  to confirm saving.</p>
	<p>After confirming and saving, the multifunctional display pane will return to the flashing bar for the current program step.</p>





## Shut-down

### Shutting the refrigerated incubator down

This chapter provides instructions for shutting the refrigerated incubator down for prolonged periods of time, that is, at least for several days in a row.



	 <b>WARNING</b>	<b>Contamination hazard</b>
<b>If the work space surfaces are contaminated, harmful biological material may spread to the environment of the refrigerated incubator.</b>		
<b>To rule out any risk for subsequent users, perform a full cleaning, disinfection and decontamination cycle to the standards set out in the section “<a href="#">Cleaning and Disinfection</a>” on <a href="#">page 9-1</a> if you suspect (or if you are positive) that harmful biological material has been processed with the refrigerated incubator.</b>		

1. Remove the containers with the cultures, all accessories, and other objects from the work space.
2. Clean and disinfect the work space, as explained in the section “Cleaning and Disinfection” on page 9-1 or - if the above warning note applies.
3. Unplug the power cord and secure it against accidental reconnection.
4. Until the refrigerated incubator is shut down, the work space must be continuously ventilated. Leave the glass door and the outer door open and secure them against accidental closure.

Shut-down  
Shutting the refrigerated incubator down

## Cleaning and Disinfection

### Cleaning

	<div style="border: 1px solid black; padding: 5px;"> <div style="display: flex; align-items: center; margin-bottom: 10px;">  <div style="margin-left: 5px;"> <p><b>CAUTION</b> Incompatible cleaners</p> </div> </div> <p>Some refrigerated incubator components are made of plastics. Solvents may attack plastics. Strong acids or alkaline solutions may cause embrittlement of plastics.</p> </div> <div style="border: 1px solid black; padding: 5px;"> <div style="display: flex; align-items: center; margin-bottom: 10px;">  <div style="margin-left: 5px;"> <p><b>CAUTION</b> Moisture-sensitive components</p> </div> </div> <p>Do not spray cleaning agent onto the control panel and the interfaces at the rear of the refrigerated incubator. When wiping the refrigerated incubator clean, always make sure that no moisture enters into these components. Wipe the display window down with a slightly dampened cloth, then wipe dry with a rag made of 100% microfiber.</p> </div>
---	--

### Cleaning Exterior Surfaces

Remove dirt residues and depositions thoroughly using a solution of lukewarm water and commercial detergent.





Wipe the surfaces and condense water dish clean using a clean cloth and clear water.

Then, wipe the surfaces dry using a clean cloth.





### Wipe / Spray Disinfection

The manual wipe and spray disinfection is a three-stage process:

- predisinfection,
- cleaning,
- final disinfection.

	<p> <b>Alcoholic disinfectants!</b></p> <p>Disinfectants having an alcohol content of more than 10% may form, in combination with air, easily combustible and explosive gas mixtures.</p> <p>When using such disinfectants, avoid open flames or exposure to excessive heat during the entire disinfection process!</p> <p>Use such disinfectants only in adequately ventilated rooms.</p> <p>After the disinfectant has been allowed to react, wipe the cleaned refrigerated incubator components thoroughly dry.</p> <p>Observe safety regulations to avoid fire and/or explosion hazard caused by alcohol-containing disinfectants.</p> <p> <b>Chloride-containing disinfectants!</b></p> <p>Chloride-containing disinfectants can corrode stainless steel.</p> <p>Use only disinfectants that do not affect stainless steel!</p>
	<p> <b>Decontamination or cleaning agents</b></p> <p>Thermo Electron LED GmbH or his agent is to be consulted if there is any doubt about the compatibility of decontamination or cleaning agents.</p>

## Preparing the Manual Wipe/Spray Disinfection

	 <b>WARNING</b> Health hazard
	<p>The surfaces of the work space may be contaminated. Contact with contaminated cleaning liquids may cause infections. Disinfectants may contain harmful substances.</p> <p>When cleaning and disinfecting, always observe the safety instructions and hygiene guidelines!</p> <ul style="list-style-type: none"><li>• Wear safety gloves.</li><li>• Wear safety goggles.</li><li>• Wear mouth and respiratory system protection gear to protect your mucous membranes.</li><li>• Observe the safety instructions of the disinfectant's manufacturer and the hygiene supervisor.</li></ul>
	

## Predisinfection

1. Remove all samples from the work space and store them in a safe place.
2. Spray disinfectant onto the surfaces of the work space and of the accessories or wipe the surfaces clean using disinfectant.

	 <b>CAUTION</b> Risk of injury caused by breaking of glass panel
	<p>The glass panel may only be removed by properly trained and authorized specialists. The glass panel must be held by two persons.</p>

3. Allow time for the disinfectant to act as specified by the manufacturer.

	 Disinfecting hard-to-reach components
	<p>Spray the sensor and other hard-to-reach components with disinfectant!</p>



	
	<p>Check to ensure that the air baffles are securely screwed into place after cleaning and moving the unit.</p>

## Cleaning

1. Remove all internals from the specimen chamber.
2. Make the Peltier-System in the chamber accessible for cleaning
  - Dismantle and remove the air baffle to the chamber interior rear wall and spray it with disinfectant
  - Loosen cable connector and fixing nut from the useable work space fan
  - Remove useable work space fan and carefully wipe with disinfectant and lukewarm water
  - Protect cable connector with insulating tape against moisture
3. Remove condensate water dish on the rear wall outside and gently clean with disinfectant and lukewarm water
4. Attach cleaning hose to the condensate drain piping and lead the hose end in a bucket
5. Spray heat exchanger fins and cover plate of the Peltier system with disinfectant and wait about 3 minutes
6. Rinse heat exchanger fins and cover plate of the Peltier system with lukewarm water
7. Wipe off the specimen chamber surfaces, air baffle and the internals that have been removed from the chamber using lukewarm water mixed with standard rinsing agents. Completely remove any tenacious impurities using rinsing agent and warm water.
8. Re-rinse the cleansed surfaces 3 to 5 times with autoclaved water to completely remove any cleaning agent residues.
9. After this, wipe the cleansed surfaces, air baffle and internals dry with a soft, sterile cloth.

## Final Disinfection

1. Spray the specimen chamber surfaces and the internals removed from this chamber again with disinfectant, or wipe them down.
2. Let the disinfectant work on the surfaces/internals as detailed in the manufacturer's instructions.
3. Re-install the useable work space fan, the air baffle and all other internals in the specimen chamber.
4. Remove Pipe cleaning hose to the condensate drain piping and position drain pan back on the rear panel accordingly.

	 <p><b>DANGER</b> Bio-hazard</p> <p>Be sure to determine the current operating condition of the refrigerated incubator before you open the door!</p> <p>Cleaning must be performed immediately if any biohazardous material is spilled in or on the refrigerated incubator.</p>
---	--

## Maintenance

Maintenance and inspection at regular intervals of the features and components listed below are mission-critical to maintain the product in a fully operative and safe condition and avoid malfunctions due to aging and wear. Failure to perform maintenance on a regular basis may result in:

- deviations in heating performance
- damage to samples
- loss of control over temperature distribution throughout the work space

## Inspections and Checks

To ensure the operational performance and safety of the refrigerated incubator and its functions, the components listed below must be checked at regular intervals.

### Regular Checks

- Check the refrigerated incubator for overall cleanliness and remove any residues from previous processes.
- Check the locking screw for the glass panel

### Semi-annual Inspection

- Check integrity and proper seating of the seal.
- Check heat exchangers of pollution.
- Check and if necessary clean the condensate water dish.
- Perform functional check of the control panel and of the refrigerated incubator's built-in controller.
- Perform electrical safety check in accordance with the relevant national regulations.

	<p><b>NOTE</b> <b>Functional Check</b></p> <p>If safety devices were removed or disabled for inspections, the refrigerated incubator must not be operated before the safety devices have been reinstalled and checked for their correct function.</p>
	<p><b>WARNING</b> <b>Spare Parts and User Modifications</b></p> <p><b>To avoid major malfunctions of the refrigerated incubator and associated safety hazards that may result in death, serious injuries, or damage to the refrigerated incubator and other equipment, use spare parts approved by Thermo Scientific only. Third-party spares without Thermo Scientific approval void the limited warranty.</b></p> <p><b>Do not modify the refrigerated incubator in any way without obtaining the prior written authorization from Thermo Scientific. Unauthorized modifications may compromise operational safety and give rise to hazards that may result in death, serious injuries, or damage to the refrigerated incubator and other equipment.</b></p>

## Service Intervals

During running operation, the following service works must be performed:

### 3-monthly service

- Perform the comparative temperature measurement outlined in the following section.

### Annual Service

- Have the refrigerated incubator inspected and services by a Thermo Scientific authorized Technical Service agent.

	<p><b>NOTE</b> <b>Service contract</b></p> <p>Thermo Electron LED GmbH offer a product-specific service contract comprising all necessary tests and service work.</p>
--	---



## Preparing Temperature Calibration

To determine the exact measured value of the refrigerated incubator's integral temperature sensor, a temperature comparison measurement must be performed every three months. If a major temperature deviation is found during this check, temperature calibration is required. During this process, the temperature controller of the refrigerated incubator is set to the value measured during the temperature comparison measurement.

Use a calibrated measuring instrument with an accuracy of  $< \pm 0.1 \text{ }^\circ\text{C}$  ( $0.18 \text{ }^\circ\text{F}$ ) for this test.

To minimize temperature variations during the measurement, put the measuring sensor in an isothermal container (such as a bowl filled with glycerol) before placing it in the work space. Use the center of the work space as the reference location for the comparison measurement.

<b>NOTE</b>	<b>Isothermal container</b>
Do not use a container filled with water as an isothermal container because the evaporation of water will result in a lower temperature reading.	
<b>NOTE</b>	<b>Excessive work space temperatures</b>
Excessive work space temperatures after the calibration may be reduced by leaving the doors open for approx. 30 seconds.	

## Comparison Measurement Procedure

1. Turn the refrigerated incubator on using the power switch.
2. Set the temperature set value and allow the refrigerated incubator to stabilize. This may take several hours.
3. Place the measuring device in the center area of the work space. Alternatively, a temperature sensor may be positioned in this location. Route the connecting cable between the glass panel and the interior tank.
4. Close the doors.
5. Wait until the temperature value displayed on the measuring instrument has stabilized.
6. Use the temperature reading from the measuring device to calibrate temperature control manually, as explained [“Entering the Calibration Reference Temperature Manually”](#) on [page 7-23](#).

## Temperature Calibration Procedure

For detailed instructions on how to perform a manual temperature calibration, please refer to the instructions in the section “[Calibration](#)” on [page 7-23](#).

	<table border="1"><tr><td data-bbox="467 359 784 443"><b>NOTE</b></td><td data-bbox="808 380 1243 411"><b>Excessive work space temperature</b></td></tr><tr><td colspan="2" data-bbox="453 468 1253 531">Excessive work space temperatures after the calibration can be reduced by leaving the doors open for approx. 30 seconds.</td></tr></table>	<b>NOTE</b>	<b>Excessive work space temperature</b>	Excessive work space temperatures after the calibration can be reduced by leaving the doors open for approx. 30 seconds.	
<b>NOTE</b>	<b>Excessive work space temperature</b>				
Excessive work space temperatures after the calibration can be reduced by leaving the doors open for approx. 30 seconds.					

## Replacing the Door Seal

<b>NOTE</b>	<b>Special door seals</b> <b>There are special door seals available, please refer to the accessory list:</b> <ul style="list-style-type: none"><li>• Viton gasket made for silicone-free applications</li><li>• Special gasket for higher humidity applications (reduces risk of condensation)</li></ul>
-------------	---

The door seal of the outer door is located in the retaining slot.

The door seal should be inspected for any signs of embrittlement at half-yearly intervals.

No tools are required to replace the seal.

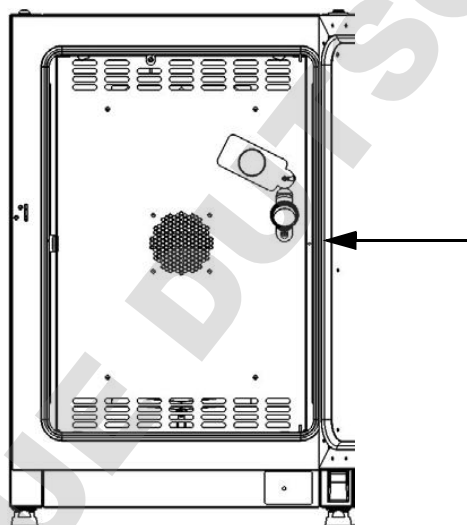

**Figure 10-1 Door Seal Replacement**

1. Pull the seal out of the guide slot.
2. Starting on the hinge side of the door, position the end of the new seal at the location indicated by the arrow in [figure 10-1](#) above.
3. Gently press the seal into the slot, working around the circumference of the door. In corner areas in particular ensure that the seal lip is installed without any wrinkles and that the seal is not stretched or compressed.
4. Make sure that the seal is positioned correctly in the slot and flush with the door frame. Correct, if necessary.



## Replacing the Power Cord

If the power cord is damaged, it must be replaced by an original spare part. Using a standard power cord with a lower thermal withstand capabilities is prohibited.

## Returns for Repair

Prior to returning any materials, please contact our Customer Service Department for a "Return Materials Authorization" number (RMA).

Material returned without an RMA number will be refused.

	 <b>WARNING</b>	<b>Contamination hazard</b>
<p>The refrigerated incubator may have been used for treating and processing infectious substances, which may have caused contamination of the refrigerated incubator and its components. Prior to return shipment, it is therefore mandatory that all refrigerated incubator components be properly decontaminated..</p>		
<ul style="list-style-type: none"><li>• Clean the refrigerated incubator components thoroughly, then disinfect or decontaminate them (depending on application).</li><li>• Fill in and attach a safety declaration with details on decontamination activities performed to the items that are to be repaired.</li></ul>		

## Disposal

	<p><b>WARNING</b> Contamination hazard</p> <p>The refrigerated incubator may have been used for treating and processing infectious substances, which may have caused contamination of the refrigerated incubator and its components. Prior to disposal, it is therefore mandatory that all refrigerated incubator components be properly decontaminated.</p> <p>Clean the refrigerated incubator components thoroughly, then disinfect or decontaminate them (depending on application).</p> <p>Attach a declaration of decontamination with details on decontamination activities performed to the items that are to be disposed of.</p>
---	---

## Overview of Materials Used

Component	Material
Thermal insulation components	Glass wool
Printed circuit boards	Coated electrical components contain various plastics materials. Components mounted on circuit boards containing epoxy resin bonder.
Plastic components, general	see material labeling
Exterior housing	Galvanized steel sheet, painted
Device rear panel	Galvanized steel sheet
Outer door	Galvanized steel sheet, painted, + stainless steel (optional)
Door inner panel	Stainless steel 1.4301
Control panel and display window protective foil	Polyethylene

Disposal  
Overview of Materials Used

Component	Material
Peltier-Element	Bismutelluride, Silicium-Germanium, Aluminium oxide ceramics, copper (contains nickel and solder), aluminium, Polyethylene, Polyolefine, Polypropylene, C1008 steel, flame retardant thermoplastic
Work space containers, installed components and shelves	Stainless steel 1.4301
Door frame seal	Silicone
Glass screen	Sodium silicate glass
Fan wheel	Stainless steel 1.4016
Cables	Plastic-sheathed stranded copper wire
Packaging	Corrugated board, polyethylene film, and styrofoam, chemically untreated wood

## Error Codes

Table 12-1 below lists the error messages that may appear in the control panel display window (see “Error Log” on page 7-22) and provides instructions for clearing such alarms.

**Table 12-1 Heratherm refrigerated incubator Error Codes**

Error Message & Code	Root Cause	Alarm Response	Alarm Clearing Instructions*
Door Open Error (only if option door switch installed) (E001)	The door switch has triggered an alarm because the door has been open for more than 10 minutes.	Audible alarm activated, alarm relay energized, message shown on display.	Close the door.
Display Error (E002)	Display communication error. The built-in controller was unable to restore communication with the control panel.	Audible alarm activated, alarm relay energized, message shown on display. Reset after 30 s.	Power cycle the device by unplugging, then reconnecting the power cord. If this doesn't solve the problem, call service.
Mirrored Parameter Loaded (E003)	The controller was unable to read the user-specific settings and had to resort to an emergency parameter set held in mirrored storage.	Alarm relay energized. Fallback to mirrored parameter storage. Device continues to run without loss of functionality, including user-specific settings.	Check the latest settings, for example the set value.
Factory Parameter Loaded (E004)	The controller was unable to read the mirrored parameter set and had to resort to factory-preset parameters.	Fallback to factory-preset parameters. Audible alarm activated, alarm relay energized, message shown on display. User-specific settings may be lost - for example, the temperature display unit preference, or user programs.	Acknowledge by pressing <b>ESC</b> . Re-enter customer-specific settings.
Default Parameter Loaded (E005)	The controller was unable to read the factory-preset parameters and had to resort to default settings	Fallback to default parameters. Audible alarm activated, alarm relay energized, message shown on display. The device is completely inoperative.	Call service.
Power Down Error (E007)	Power has been cut off (power outage) while the device was running.	Audible alarm activated, alarm relay energized, message shown on display.	Check the power supply. Power up then device, then acknowledge the alarm by pressing <b>ESC</b> .

Table 12-1 Heratherm refrigerated incubator Error Codes

Error Message & Code	Root Cause	Alarm Response	Alarm Clearing Instructions*
Program Error (008)	Error in processing a user program.	Program is aborted. Audible alarm activated, alarm relay energized. The Peltier-System is switched off and the last setpoint value before program start is set.	Acknowledge by pressing (ESC).
Config Error (E012)	General device configuration error.	Audible alarm activated, alarm relay energized, message shown on display. The device is completely inoperative.	Call service.
OTP error (E013)	Klixon contact not closed.	Overtemperature Protection fault. Audible alarm activated, alarm relay energized, message shown on display. Bridging across Klixon contact has failed.	Restart the device. If this doesn't solve the problem, call service.
Incorrect voltage (E014)	The applied voltage is too high or too low.	Audible alarm activated, error message shown on display.	Apply the correct voltage as indicated on the nameplate and acknowledge the error.
Temp > limit (E015)	The measured actual value is over the limit value from the customer selected preset overtemperature cut-off	Audible alarm activated, alarm relay energized, message shown on display. Peltier-heating-function is permanently switched off.	Switch off overtemperature cut-off (TWB) or set limit temperature higher than the actual temperature. Check limit temperature exceeding, call service. If the error occurs repeatedly.
Sensor Error (E100)	Process sensor damaged. The actual measured value is out of range.	Audible alarm activated, alarm relay energized, message shown on display. Control transferred to reference sensor. If both sensors are defective, disable all control circuits.	Call service.
Peltier error (E101)	Peltier heating power is insufficient or defective Peltier heating function.	Audible alarm activated, alarm relay energized, message shown on display. Sample protection is activated and regulated to set-point value.	If the error occurs repeatedly, call service.
Temperature Not Plausible (E103)	The difference between the control and reference sensors exceeds the maximum permissible deviation, rendering the measurement implausible.	Device uses the sensor that indicates the higher temperature for servo control. Audible alarm activated, alarm relay energized, message shown on display. Error can be acknowledged and doesn't reset.	If the error occurs repeatedly, call service.



Table 12-1 Heratherm refrigerated incubator Error Codes

Error Message & Code	Root Cause	Alarm Response	Alarm Clearing Instructions*
Calibration Value Too High (E104)	The calibration reference value calculated on the basis of the user input falls short of the upper limit for calibration references.	Fallback to previous calibration reference. Audible alarm activated, alarm relay energized, message shown on display.	Check the external reference sensor for proper function and replace, if necessary. If this does not solve the problem, call service.
Calibration Value Too low (E105)	The calibration reference value calculated on the basis of the user input exceeds the lower limit for calibration references.	Fall back to previous calibration reference. Audible alarm activated, alarm relay energized, message shown on display.	Check the external reference sensor for proper function and replace, if necessary. If this does not solve the problem, call service.
Constant Sensor Signal (E106)	None of the decimal places of the A/D-converter output for the process sensor has changed over a specific time period.	Control transferred to reference sensor, audible alarm activated, alarm relay energized, message shown on display. If both sensors are defective, all control circuits will be disabled.	Call service.
Constant Reference Sensor Signal (E107)	None of the decimal places of the A/D-converter output for the reference sensor has changed over a specific time period.	Control continues on process sensor, audible alarm activated, alarm relay energized, message shown on display. If both sensors are defective, all control circuits will be disabled.	Call service.
Constant Sample Sensor Signal (E108)	None of the decimal places of the A/D-converter output for the sample sensor has changed over a specific time period.	Audible alarm activated, alarm relay energized, message shown on display.	Call service.
Temperature Too High (E111)	The actual measured value exceeds the upper limit of the permissible error range.	Audible alarm activated, alarm relay energized, message shown on display. Heater turned off until upper limit of hysteresis is recovered. Servo control operations continue. Alarm can be acknowledged, and goes away when the difference between the actual and set values ceases to exist. Note: This error does not indicate a defective triac.	Open the door to speed up cool-down. Check whether the device was loaded with a hot object, if so, remove. Ensure that the equipment was operated with at least one perforated shelve and with the door not opened longer than 10 min. If this doesn't solve the problem, call service.
Sensor Error (E112)	The measured actual value is out of range.	Audible alarm activated, alarm relay energized, message shown on display. Control continues on process sensor. If both sensors are defective, all control circuits will be disabled.	If error does not go away, call service.

**Table 12-1 Heratherm refrigerated incubator Error Codes**

Error Message & Code	Root Cause	Alarm Response	Alarm Clearing Instructions*
Sensor Error (E113)	Sample sensor damaged. The actual measured value is out of range.	Audible alarm activated, alarm relay energized, message shown on display.	Call service.
ADC Error (E114)	A/D converter does not supply a plausible output. Measurement across reference resistor has failed. ADC converter may be defective.	Audible alarm activated, alarm relay energized, message shown on display. All control circuits disabled.	Call Service.
Watchdog error (E115)	Watchdog test failed on power-up.	Audible alarm activated, alarm relay energized, message shown on display.	Call service.

\*Clearing should mute the audible alarm, de-energize the alarm relay, and clear the message from the control panel display.

## Technical Data

The technical data are valid only for an empty device equipped with three shelves and a spray-painted outer enclosure. Options may have an impact on the specified performance.

**Table 13-1**

Models		IMP 180	IMP 400		
Parameter	Unit				
Chamber volume	L/cu ft	178/6.3	381/13.5		
Chamber temperature range	°C/°F	5-70 (41-158)			
<b>Unit dimensions</b>					
Internal dimensions W x D x H	mm/in	494x590x708 / 19.5x23.2x27.9	600x590x1335 / 23.6x23.2x52.6		
Internal dimensions (useable space) W x D x H	mm/in	464x543x708 / 18.3x21.4x27.9	544x524x1335 / 21.4x20.6x52.6		
External dimensions (without feet / castors) W x D x H	mm/in	640x738x920 / 25.2x29.1x36.2	778x770x1545 / 30.6x30.3x60.8		
Footprint	m <sup>2</sup> /ft <sup>2</sup>	0.47 / 5.1	0.56 / 6.0		
Number of shelves: standard/maximum		2 / 9	2 / 17		
Number of shelf positions		19	39		
Shelf size	mm/in	439x505 / 17.28x19.88	528x498 / 20.79x21.06		
Loading capacity per shelf	kg/lbs	25/55	30/66		
Loading capacity of unit	kg/lbs	75/165	75/165		
Weight of the unit	kg/lbs	84/185	167/368		
Weight of unit incl. packing	kg/lbs	97/214	216/476		
External dimension incl. packing W x D x H	mm/in	960x770x1200 / 37.8x30.3x47.2	1030x1100x1900 / 40.6x43.3x74.8		
Access port diameter	mm/in	42 / 1.7	42 / 1.7		
<b>Temperature Performance</b>					
Heat up / cool down time (work space unoccupied), from ambient temperature 22 °C (72 °F) to (according to DIN 12880)		5°C/ (41°F)	55/60	5°C/ (41°F)	55/60
	min	20°C (68°F)	7/8	20°C (68°F)	9/10
		37°C (99°F)	31/34	37°C (99°F)	52/56
		70°C (158°F)	61/66	70°C (158°F)	92/101

Table 13-1

Models		IMP 180		IMP 400	
Recovery time (work space unoccupied), (door opening 30 sec, according to DIN 12880) typical valve / max. value	min	5°C (41°F)	7/9	5°C (41°F)	8/10
		20°C (68°F)	<1/1	20°C (68°F)	2/3
		37°C (99°F)	2/3	37°C (99°F)	2/4
		70°C (158°F)	8/10	70°C (158°F)	10/12
Temperature stability, temporal mid of work space according to DIN 12880 at 20°C, 25°C, 37°C, (68°F, 77°F, 99°F)	K	≤ ±0,1		≤ ±0,1	
Temperature uniformity according to DIN 12880 at typical value / max. value	K	5°C (41°F)	≤ ±0.9/≤ ±1.1	5°C (41°F)	≤ ±1.3/≤ ±1.5
		20°C (68°F)	≤ ±0.2/≤ ±0.3	20°C (68°F)	≤ ±0.3/≤ ±0.4
		37°C (99°F)	≤ ±0.5/≤ ±0.6	37°C (99°F)	≤ ±0.6/≤ ±0.7
		50°C (122°F)	≤ ±1.0/≤ ±1.2	50°C (122°F)	≤ ±1.3/≤ ±1.5
		70°C (158°F)	≤ ±1.9/≤ ±2.1	70°C (158°F)	≤ ±2.0/≤ ±2.2
BTU output at ambient temperature of 22°C (72°F)	W	5°C (41°F)	400	5°C (41°F)	1000
		20°C (68°F)	100	20°C (68°F)	230
		37°C (99°F)	60	37°C (99°F)	170
		70°C (158°F)	130	70°C (158°F)	300
<b>Electrical data</b>					
Power line voltage (+/- 10%)		100-240		100-240	
Power line frequency	Hz	50/60		50/60	
Power rating, measured at ambient temperature of 28°C/82°F	W	450 920 (230V *) / 700 (120V *)		900 1360 (230V *) / 1140 (120V *)	
Max. current, measured at ambient temperature of 28°C/82°F	A	1,9 - 4,5 4,0 (230V *) / 5,8 (120V *)		3,8 - 9,0 6,0 (230V *) / 9,5 (120V *)	
Energy consumption, measured at ambient temperature of 22°C/72°F	typical value / max. value	5°C/ (41°F)	320/350	5°C/ (41°F)	560/590
		20°C (68°F)	80/110	20°C (68°F)	150/180
		37°C (99°F)	90/110	37°C (99°F)	170/190
		70°C (158°F)	220/240	70°C (158°F)	390/410
Earthing system (e.g. 1/N/PE)		1/N/PE AC			
IP protection system		IP 20			
Protection class		I			
Overvoltage category according to IEC 60364-4-443		II			
Device fusing building site	A	16			
Device fusing on PCB	A	2x15			
<b>Environmental conditions</b>					
Ambient temperature range	°C (°F)	18-28 (64-82)			

\* with internal power outlet (optional)

**Table 13-1**

<b>Models</b>		<b>IMP 180</b>	<b>IMP 400</b>
Max. rel. humidity in service at or below 28°C (82°F), non condensing	% r.H.	70	
Storage temperature range	°C (°F)	20-60 (68-140)	
Max. humidity in storage, non condensing	% r.H.	90	
Post-transport acclimation time	h	2	
Noise level, measuring point: device-distance 1.0 m, height 1.6m)	dB(A)	< 50	< 52
Pollution degree according to IEC EN 61010-1		2	
<b>Site conditions</b>			
Maximum altitude above sea level	m/y NN	2000/2187	
Minimum side clearance	mm/in	150/5.9	150/5.9
Minimum front clearance	mm/in	814/32	810/31.9
Minimum back wall clearance	mm/in	130/5.1	150/5.9
Minimum bottom clearance	mm/in	200/8	-/-
Minimum top clearance	mm/in	300/12	360/14.2

DOMINIQUE DUTSCHER SAS

## Spare Parts and Accessories

Material No.	Description
50126667	Stacking adapter Heratherm 180L
50127435	Stacking feet for Heratherm Incubators and heating and drying ovens
50127438	Kit door seal for Heratherm 180L
50127442	Door inner panel seal for Heratherm IMP 180 and IMP 180-S
50127443	Levelling feet for Heratherm refrigerated incubators and heating & drying ovens
50127468	Glass door hinges for Heratherm refrigerated incubators
50127474	Kit glass door IGS 180, IMP 180
50127480	Door hook catch for Heratherm refrigerated incubators and heating & drying ovens with a door stop on the right side
50127481	Door hook catch for Heratherm refrigerated incubators and heating & drying ovens with a door stop on the left side
50127766	Wire mesh shelf IGS IMP 180, including 2 shelf supports
50127777	Stainless steel perforated shelf IMP 180 / IMP 180-S / OMH 180 / OMH 180-S/OMS 60/100/180, including 2 shelf supports
50127861	Retaining springs for Heratherm refrigerated incubators and heating & drying ovens
50128212	Fuse holder for Heratherm IMP
50128265	Lowenstein holder IGS 100 / IMP 10 / IMP 100-S / IGS 180 / IMP 180
50128704	Kit Anti-tilt anchor
50128792	Drip tray for Heratherm incubators 180 L (stainless steel), including 2 shelf supports.
50128815	Petri dish holder 50 mm (2 inch) IGS 180 / IMP 180 / IMP 180-S
50128819	Petri dish holder 90 mm (3.54 inch) IGS 180 / IMP 180 / IMP 180-S
50128881	Wire-mesh shelf (reinforced) for Heratherm IMH 180 / IMH 180-S / IMP 180 / OMH 180 / OMH 180-S, including 2 shelf supports
50128962	Kit Shelving system with glass door lock IGS 180, IMP 180, IMP 180-S
50130659	Kit Viton door seal 180 L Heratherm

## Spare Parts and Accessories

Material No.	Description
50134322	Kit glass door cpl 400 HTM
50134326	Door gasket 400 L HTM
50134333	Kit castor's 400 / 750 HTM
50134334	Kit shelf rack set cpl HTM 400 / 750
50134908	Door seal with vents for Heratherm 180 L
50135056	Glass door handle Heratherm incubators 400 L / 750 L
50135241	Perforated shelf for Heratherm incubators 400 L (stainless steel), including 2 shelf supports
50135243	Pair of wire-mesh shelves for Heratherm IMH 400 / IMH 400-S / IMP 400, including 4 shelf supports
50135869	Viton door seal, silicone free, for Heratherm 400L
50152273	A pair of fuses Heratherm IMP 180 / IMP 400
50152305	Door seal with vents for Heratherm 400 L
50152444	Condensate water dish for Heratherm IMP 180 / IMP 400



# Device Log

refrigerated incubator type:		Part number:		
Serial number:		Service number:		
Location		Operator's note:		
Work carried out		Notes	Date	Signature

DOMINIQUE DUTSCHER SAS

## Contact

### Overview of Thermo Fisher International Sales Organization

#### Postal address USA:

Thermo Scientific  
275 Aiken Road  
Asheville, NC 28804  
USA

#### Enquiries from USA/Canada

Sales: +1 866 984 3766  
Service: +1 800 438 4851

#### Enquiries from Latin America

Sales: +1 866 984 3766  
Service: +1 866 984 3766

#### Enquiries from Asia:

##### China

Sales: +86 10 8419 3588  
Service: Toll free 8008105118  
Support Mobile 4006505118  
or +86 10 8419 3588

##### India

Sales: +91 22 6716 2200  
Service: Toll free 1 800 22 8374  
or +91 22 6716 2200

##### Japan

Sales: +81 45 453 9220  
Service: +81 45 453 9224

#### Enquiries from the Rest of Asia/Australia/New Zealand

Sales: +852 2885 4613  
Service: +65 6872 9720

#### Enquiries from Countries not listed / Rest of EMEA

Sales: +49 6184 90 6940  
or +33 2 2803 2000  
Service: +49 6184 90 6940

## Contact

### Enquiries from Europe:

#### Austria

Sales: +43 1 801 40 0

Service: +43 1 801 40 0

#### Belgium

Sales: +32 53 73 4241

Service: +32 53 73 4241

#### Finland/Nordic/Baltic countries

Sales: +358 9 329 100

Service: +358 9 329 100

#### France

Sales: +33 2 2803 2180

Service: +33 825 800 119

#### Germany:

##### Postal Address Germany:

Thermo Electron LED GmbH

Robert-Bosch-Straße 1

D - 63505 Langenselbold

#### Phone

Sales Toll free 0800 1 536 376

or +49 6184 90 6940

Service Toll free 0800 1 112110

or +49 6184 90 6940

E-Mail [info.labequipment.de@thermofisher.com](mailto:info.labequipment.de@thermofisher.com)

#### Italy

Sales +39 02 95059 341

Service +39 02 95059 250

#### Netherlands

Sales +31 76 579 5555

Service +31 76 579 5639

#### Russia/CIS

Sales +7 812 703 4215

Service +7 812 703 4215

#### Spain/Portugal

Sales +34 93 223 0918

Service +34 93 223 0918

#### Switzerland

Service +41 44 454 1212

Service +41 44 454 1212

#### UK/Ireland

Service +44 870 609 9203

Sales +44 870 609 9203

DOMINIQUE DUTSCHER SAS

DOMINIQUE DUTSCHER SAS



Thermo Fisher Scientific,  
San Jose, CA USA is ISO Certified.

[thermoscientific.com](http://thermoscientific.com)

© 2016 Thermo Fisher Scientific Inc. All rights reserved. All trademarks are the property of Thermo Fisher Scientific Inc. and its subsidiaries. Specifications, terms and pricing are subject to change. Not all products are available in all countries. Please consult your local sales representative for details.

Thermo Fisher Scientific  
81 Wyman Street  
Waltham, MA 02451

**Thermo**  
SCIENTIFIC  
Part of Thermo Fisher Scientific