

# Thermo Scientific ClipTip Pipette Tips

Thermo Scientific™ ClipTip™ pipette tips provide a unique locking tip interface that allows stable, straight mounting on Thermo Scientific F1-ClipTip manual pipettes or E1-ClipTip electronic pipettes. ClipTip pipette tips feature “clips” that lock tips in place. Simply touch the pipette to the ClipTip pipette tip for a secure seal. The ClipTip pipette tip will only release when ejected using minimal application pressure.

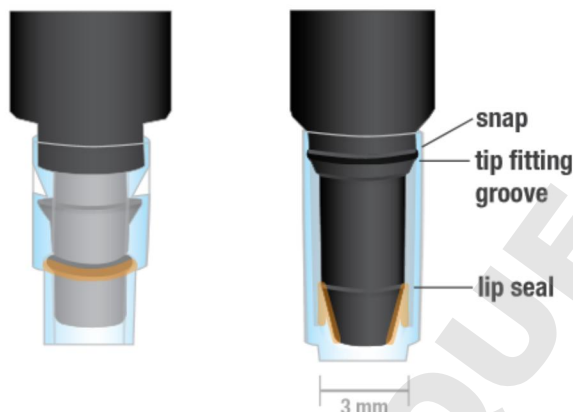

ClipTip Interlock technology that locks tips into place for a complete seal every time.

The 96-format ClipTip 12.5 and all ClipTip 384 tips feature a ‘Snap and Lip’ seal mechanism for tip attachment.

## Absolute tip attachment.

The ClipTip pipette tips lock into place to create a complete seal until released. Users have full tip control throughout pipetting, as pipette tips will only release when ejected, regardless of application pressure.

## Clip and Lip tip attachment technology.

The 96-format ClipTip 12.5 and all ClipTip 384 tips feature a ‘Snap and Lip’ seal mechanism for tip attachment. The tip has small incorporated protrusions that snap on the tip fitting flange, ensuring light-force and secure tip attachment.

## Superior ergonomics.

Simply touch the Thermo Scientific F1-ClipTip manual pipette or E1-ClipTip electronic pipette to the ClipTip to lock in place with minimal effort.

## Immediate traceability.

Each tip insert has ink-jetted lot and volume information. The convenient color key makes it easy to match the color of the F1-ClipTip pipette plunger cap or buttons on the E1-ClipTip pipette with the corresponding ClipTip pipette tip rack insert.

## Superior Contamination Control.

The interlocking tip design prevents sample contamination caused from loose, leaking tips that can fall off. Filter tips prevent carry over contamination protecting both the pipette and the sample.

## Low Retention.

Innovative technology creates a hydrophobic inner pipette tip surface to minimize liquid retention, and enable maximum sample recovery. This low retention technology is completely inert and increases accuracy and precision. Available in ClipTip 20-1250 96-format tips.

## Proven Quality.

Certified free of RNase, DNase, DNA, ATP and Endotoxin\*.

## Environmental responsibility.

The ClipTip pipette tip reload system incorporates re-usable hinged racks with plastic reload sleeves which which reduces waste by an average of 35%.

## Versatile Tip Range.

Choose from six sizes in 96-format: 12.5, 20, 50, 200, 300, 1000 and 1250 µl

Choose from three sizes in 384-format: 12.5, 30 and 125 µl



\*A lot specific Certificate of Quality with purity level information is provided in every unit box.

**Thermo**  
SCIENTIFIC

# Thermo Scientific ClipTip Pipette Tips

Item No.	Description	Color Key	Volume Range	Packaging
<b>96-format ClipTip Tips</b>				
94410040	ClipTip 12.5*	●	0.5-12.5 µl	10 x 96/rack
94410043	ClipTip 12.5, Sterile*	●	0.5-12.5 µl	10 x 96/rack
94420043	ClipTip 12.5, Filter, Sterile*	●	0.5-12.5 µl	10 x 96/rack
94410210	ClipTip 20	●	1-20 µl	10 x 96/rack
94410213	ClipTip 20, Sterile	●	1-20 µl	10 x 96/rack
94410217	ClipTip 20, Reload Tower	●	1-20 µl	10 x 96/insert
94410218	ClipTip 20, Reload Tower, Sterile	●	1-20 µl	10 x 96/insert
94420213	ClipTip 20, Filter, Sterile	●	1-20 µl	10 x 96/rack
94420218	ClipTip 20, Filter Reload, Sterile	●	1-20 µl	10 x 96/insert
94410250	ClipTip 50	●	5-50 µl	10 x 96/rack
94410253	ClipTip 50, Sterile	●	5-50 µl	10 x 96/rack
94410257	ClipTip 50, Reload Tower	●	5-50 µl	10 x 96/insert
94410258	ClipTip 50, Reload Tower, Sterile	●	5-50 µl	10 x 96/insert
94420253	ClipTip 50, Filter, Sterile	●	5-50 µl	10 x 96/rack
94420258	ClipTip 50, Filter Reload, Sterile	●	5-50 µl	10 x 96/insert
94410310	ClipTip 200	●	2-200 µl	10 x 96/rack
94410313	ClipTip 200, sterile	●	2-200 µl	10 x 96/rack
94410317	ClipTip 200 Reload Tower	●	2-200 µl	10 x 96/insert
94410318	ClipTip 200 Reload Tower, sterile	●	2-200 µl	10 x 96/insert
94420313	ClipTip 200 Filter, sterile	●	2-200 µl	10 x 96/rack
94420318	ClipTip 200 Filter Reload, sterile	●	2-200 µl	10 x 96/insert
94410510	ClipTip 300, Racked	●	10-300 µl	10 x 96/rack
94410513	ClipTip 300, Racked, Sterile	●	10-300 µl	10 x 96/rack
94410517	ClipTip 300, Reload Tower	●	10-300 µl	10 x 96/insert
94410518	ClipTip 300, Reload Tower, Sterile	●	10-300 µl	10 x 96/insert
94420513	ClipTip 300, Filter, Racked, Sterile	●	10-300 µl	10 x 96/rack
94420518	ClipTip 300, Filter, Reload, Sterile	●	10-300 µl	10 x 96/insert

Item No.	Description	Color Key	Volume Range	Packaging
94410710	ClipTip 1000	●	30-1000 µl	8 x 96/rack
94410713	ClipTip 1000, Sterile	●	30-1000 µl	8 x 96/rack
94410717	ClipTip 1000, Reload Tower	●	30-1000 µl	8 x 96/insert
94410718	ClipTip 1000, Reload Tower, Sterile	●	30-1000 µl	8 x 96/insert
94420713	ClipTip 1000, Filter, Sterile	●	30-1000 µl	8 x 96/rack
94420718	ClipTip 1000, Filter Reload, Sterile	●	30-1000 µl	8 x 96/insert
94410810	ClipTip 1250	●	50-1250 µl	8 x 96/rack
94410813	ClipTip 1250, Sterile	●	50-1250 µl	8 x 96/rack
94410817	ClipTip 1250, Reload Insert	●	50-1250 µl	8 x 96/insert
94410818	ClipTip 1250, Reload Insert, Sterile	●	50-1250 µl	8 x 96/insert
94420813	ClipTip 1250, Filter, Sterile	●	50-1250 µl	8 x 96/rack
94420818	ClipTip 1250, Filter Reload, Sterile	●	50-1250 µl	8 x 96/insert

## 384 ClipTip Tips\*

Item No.	Description	Color Key	Volume Range	Packaging
94410050	ClipTip 384 12.5	●	0.5-12.5 µl	10x384/rack
94410053	ClipTip 384 12.5, Sterile	●	0.5-12.5 µl	10x384/rack
94420053	ClipTip 384 12.5, Filter, Sterile	●	0.5-12.5 µl	10x384/rack
94410100	ClipTip 384 30	●	1-30 µl	10x384/rack
94410103	ClipTip 384 30, Sterile	●	1-30 µl	10x384/rack
94420103	ClipTip 384 30 Filter, Sterile	●	1-30 µl	10x384/rack
94410150	ClipTip 384 125	●	2-125 µl	10x384/rack
94410153	ClipTip 384 125, sterile	●	2-125 µl	10x384/rack
94420153	ClipTip 384 125 Filter, sterile	●	2-125 µl	10x384/rack

\* ClipTip 12.5 and ClipTip 384 tips do not have interlocking tip interface or low retention technology.

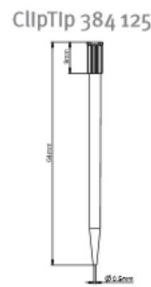
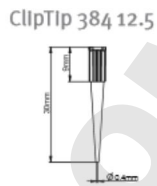
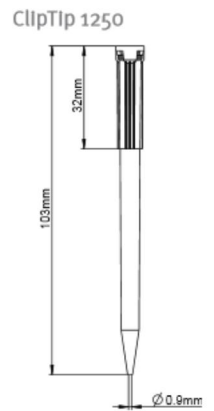
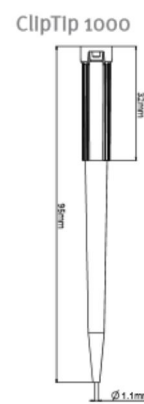
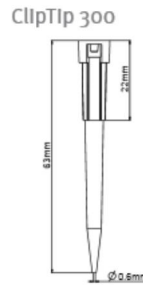
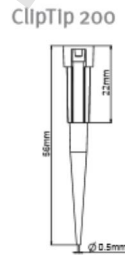
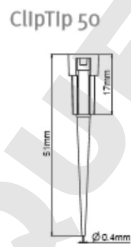
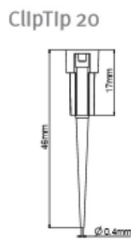
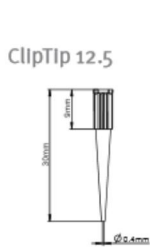

Description	Overall Tip Length	Tip Shoulder (Proximal)	Inner Orifice Diameter (Distal)
<b>96 ClipTip Tips</b>			
ClipTip 12.5*	30 mm	9 mm	0.4 mm
ClipTip 20	46 mm	17 mm	0.4 mm
ClipTip 50	51 mm	17 mm	0.4 mm
ClipTip 200	56 mm	22 mm	0.5 mm
ClipTip 300	63 mm	22 mm	0.6 mm
ClipTip 1000	95 mm	32 mm	1.1 mm
ClipTip 1250	103 mm	32 mm	0.9 mm
<b>384 ClipTip Tips*</b>			
ClipTip 384 12.5	30 mm	9 mm	0.4 mm
ClipTip 384 30	44 mm	9 mm	0.4 mm
ClipTip 384 125	64 mm	9 mm	0.5 mm

\* All ClipTip pipette tips are low retention with the exception of 384 and 12.5 models. ClipTip 384 and ClipTip 12.5 tips and compatible E1-ClipTip models do not have interlock technology.

# ClipTip Compatibility

Order No.	Description	ClipTip						
		ClipTip 12.5	ClipTip 20	ClipTip 50	ClipTip 200	ClipTip 300	ClipTip 1000	ClipTip 1250
<b>F1-ClipTip Manual Pipettes</b>								
Single channels								
4641170	F1-ClipTip 1-10µl		•					
4641180	F1-ClipTip 2-20µl		•					
4641190	F1-ClipTip 5-50µl			•				
4641200	F1-ClipTip 10-100µl				•			
4641210	F1-ClipTip 20-200µl					•		
4641220	F1-ClipTip 30-300µl						•	
4641230	F1-ClipTip 100-1000µl							•
4651170	F1-ClipTip 1µl □x vol	•						
4651180	F1-ClipTip 5µl □x vol	•						
4651190	F1-ClipTip 10µl □x vol	•						
4651200	F1-ClipTip 20µl □x vol	•						
4651210	F1-ClipTip 25µl □x vol		•					
4651220	F1-ClipTip 50µl □x vol		•					
4651230	F1-ClipTip 100µl □x vol			•				
4651240	F1-ClipTip 200µl □x vol				•			
4651250	F1-ClipTip 250µl □x vol					•		
4651260	F1-ClipTip 500µl □x vol						•	
4651270	F1-ClipTip 1000µl □x vol							•
Multichannels								
4661110	F1-ClipTip 8-ch 1-10µl		•					
4661120	F1-ClipTip 8-ch 5-50µl			•				
4661130	F1-ClipTip 8-ch 10-100µl				•			
4661140	F1-ClipTip 8-ch 30-300µl					•		
4661150	F1-ClipTip 12-ch 1-10µl		•					
4661160	F1-ClipTip 12-ch 5-50µl			•				
4661170	F1-ClipTip 12-ch 10-100µl				•			
4661180	F1-ClipTip 12-ch 30-300µl					•		

Order No.	Description	ClipTip									
		ClipTip 12.5	ClipTip 20	ClipTip 50	ClipTip 200	ClipTip 300	ClipTip 1000	ClipTip 1250	ClipTip 12.5 384	ClipTip 30 384	ClipTip 125 384
<b>E1-ClipTip Electronic Pipettes</b>											
Single channels											
4670000	E1-ClipTip 0.5-12.5 µl	•									
4670020	E1-ClipTip 2-125 µl				•						
4670030	E1-ClipTip 10-300 µl					•					
4670040	E1-ClipTip 50-1250 µl						•				
Multichannels											
4671000	E1-ClipTip 8-ch 0.5-12.5 µl	•									
4671040	E1-ClipTip 8-ch 2-125 µl				•						
4671070	E1-ClipTip 8-ch 10-300 µl					•					
4671100	E1-ClipTip 8-ch 50-1250 µl						•				
4671010	E1-ClipTip 12-ch 0.5-12.5 µl	•									
4671050	E1-ClipTip 12-ch 2-125 µl				•						
4671080	E1-ClipTip 12-ch 10-300 µl					•					
4671090	E1-ClipTip 12-ch 30-850 µl						•				
4671020	E1-ClipTip 16-ch 0.5-12.5 µl							•			
4671030	E1-ClipTip 16-ch 1-30 µl								•		
4671060	E1-ClipTip 16-ch 2-125 µl									•	
Adjustable Tip Spacing Multichannels											
4672090	E1-ClipTip Equalizer 6-ch 50-1250 µl								•		
4672050	E1-ClipTip Equalizer 8-ch 2-125 µl				•						
4672080	E1-ClipTip Equalizer 8-ch 10-300 µl					•					
4672100	E1-ClipTip Equalizer 8-ch 50-1250 µl							•			
4672010	E1-ClipTip Equalizer 384 8-ch 0.5-12.5 µl								•		
4672030	E1-ClipTip Equalizer 384 8-ch 1-30 µl									•	
4672060	E1-ClipTip Equalizer 384 8-ch 2-125 µl										•
4672020	E1-ClipTip Equalizer 384 12-ch 0.5-12.5 µl							•			
4672040	E1-ClipTip Equalizer 384 12-ch 1-30 µl								•		
4672070	E1-ClipTip Equalizer 384 12-ch 2-125 µl										•

[thermoscientific.com/dipltip](http://thermoscientific.com/dipltip)

© 2014 Thermo Fisher Scientific Inc. All rights reserved. All trademarks are the property of Thermo Fisher Scientific Inc. and its subsidiaries. Specifications, terms and pricing are subject to change. Not all products are available in all countries. Please consult your local sales representative for details.

**North America:**  
 USA/Canada +1 800 522 7763  
 USA toll free 800 345 0206  
**Europe:**  
 Austria +43 1 801 40 0  
 Belgium +32 2 482 30 30  
 Finland/Nordic +358 9 329 100  
 France +33 2 2803 2000

Germany national toll free 08001-536 376  
 Germany international +49 6184 90 6940  
 Italy +39 02 95059 1  
 Netherlands +31 76 571 4440  
 Russia/CIS +7 (812) 703 42 15  
 Spain/Portugal +34 93 223 09 18  
 Switzerland +41 44 454 12 12  
 UK/Ireland +44 870 609 9203

**Asia:**  
 Australia +613 9757 4474  
 China +86 21 6865 4588 or +86 10 8419 3588  
 India +91 22 5542 9494  
 Japan +81 45 453 9220  
 Other Asian countries +852 2885 4613  
**Countries not listed:**  
 +49 6184 90 6940 or +33 2 2803 2000

**Thermo**  
 SCIENTIFIC

Part of Thermo Fisher Scientific