

**Thermo Scientific
Heratherm
General Protocol
Ovens**

OGS 60/100/180
OMS 60/100/180

Operating Instructions

50125556

16.03.11



© 2011 Inc. All rights reserved.

These operating instructions are protected by copyright. Rights resulting thereof, particularly reprint, photomechanical or digital postprocessing or reproduction, even in part, are only allowed with the written consent of Thermo Electron LED GmbH.

This regulation does not apply to reproductions for in-plant use.

The contents of this operating instructions manual may change at any time and without any prior notice. In case of conflicting translations into foreign languages the German-language version of these operating instructions shall be binding.

Trademarks

Heratherm™ is a registered trademark of Thermo Scientific.

Thermo Scientific is a brand owned by Thermo Fisher Scientific, Inc.

All other trademarks mentioned in the operating instructions are the exclusive property of the respective manufacturers.

Thermo Fisher Scientific
Robert-Bosch-Straße 1
D - 63505 Langenselbold
Germany

Thermo Electron LED GmbH is an affiliate to:

Thermo Fisher Scientific Inc.

81 Wyman Street
Waltham, MA 02454
USA

Thermo Fisher Scientific Inc. provides this document to its customers with a product purchase to use in the product operation. This document is copyright protected and any reproduction of the whole or any part of this document is strictly prohibited, except with the written authorization of Thermo Fisher Scientific Inc.

The contents of this document are subject to change without notice. All technical information in this document is for reference purposes only. System configurations and specifications in this document supersede all previous information received by the purchaser.

Thermo Fisher Scientific Inc. makes no representations that this document is complete, accurate or error-free and assumes no responsibility and will not be liable for any errors, omissions, damage or loss that might result from any use of this document, even if the information in the document is followed properly.

This document is not part of any sales contract between Thermo Fisher Scientific Inc. and a purchaser. This document shall in no way govern or modify any Terms and Conditions of Sale, which Terms and Conditions of Sale shall govern all conflicting information between the two documents.

Contents

Chapter 1	Safety Notes	1-1
	Basic Operating Precautions	1-1
	Operational Safety Rules.....	1-2
	Warranty	1-2
	Explanation of Safety Information and Symbols	1-3
	Safety Notes and Symbols Used Throughout These Operating Instructions	1-3
	Additional Symbols for Safety Information.....	1-4
	Symbols on the Oven	1-5
	Intended Purpose of the Oven.....	1-5
	Correct Use	1-5
	Incorrect Use.....	1-6
	Standards and Directives	1-6
Chapter 2	Delivery of the Oven	2-1
	Packaging	2-1
	Acceptance Inspection	2-1
	Scope of Supply.....	2-2
Chapter 3	Installation.....	3-1
	Ambient Conditions.....	3-1
	Intermediate Storage.....	3-2
	Room Ventilation.....	3-2
	Use with Air Exhaust Systems.....	3-2
	Space Requirements.....	3-3
	Transport	3-4
	Stacking Kit.....	3-5
	Installing the Stacking Feet.....	3-5
	Installing the Stacking Adapter	3-6
	Installing the Anti-tilt Anchor	3-7
Chapter 4	Product Description	4-1
	Heratherm OGS Series Oven Overview.....	4-1
	-Heratherm OMS Series Oven Overview.....	4-3
	Safety Devices.....	4-6
	Operating Environment	4-6
	Sensing and Control System	4-6
	Data Communications & Alarm Interface.....	4-7
	AC Power Socket.....	4-7
	Fuses.....	4-7
	Work Space Components.....	4-8
	Inner Chamber	4-8

Chapter 5 Start-up	5-1
Installing the Shelf System	5-1
Initial installation	5-1
Installing the Shelving	5-1
Preparing the Work Space	5-3
Installation or Removal of the Support Rails (OMS Series only)	5-3
Installing and Uninstalling the Rear Air Baffle (OMS Series only)	5-4
Installing and Uninstalling the Lateral Air Baffles (OGS Series only)	5-4
Installing the Shelf Support Brackets	5-6
Installing the Wire-mesh Shelves	5-7
Levelling the Oven	5-7
Connecting Power	5-8
Connection to the Power Supply Source	5-8
Connecting the RS-232 Interface	5-9
Chapter 6 Operation	6-1
Preparing the Oven	6-1
Starting Operation	6-1
Chapter 7 Handling and Control	7-1
Powering Up	7-5
Switching the Oven Off / Powering Down	7-5
Temperature Set Value	7-6
Timer	7-7
Stopping a Timer	7-8
Settings	7-9
Error Log	7-9
Calibration	7-10
Temperature Display Unit	7-11
Configuration	7-12
Chapter 8 Shut-down	8-1
Shutting the Oven Down	8-1
Chapter 9 Cleaning and Disinfection	9-1
Cleaning	9-1
Cleaning exterior surfaces	9-1
Wipe / Spray Disinfection	9-1
Preparing the manual wipe/spray disinfection	9-2
Predisinfection	9-3
Chapter 10 Maintenance	10-1
Inspections and checks	10-1
Service Intervals	10-2
Replacing the Door Seal	10-2
Replacing the Power Cord	10-3
Returns for Repair	10-3
Chapter 11 Disposal	11-1
Overview of Materials Used	11-1

WEEE Conformity 11-2

Chapter 12 Error Codes 12-1

Chapter 13 Technical Data 13-1

Chapter 14 Spare Parts and Accessories 14-1

Chapter 15 Device Log 15-1

Chapter 16 Contact 16-1

DOMINIQUE DUTSCHER SAS

DOMINIQUE DUTSCHER SAS

List of Figures

Figure 3-1 Oven Dimensions and Required Clearance.....	3-3
Figure 3-2 Lift Points.....	3-4
Figure 4-1 Heratherm OGS Series Front View	4-2
Figure 4-2 Heratherm OGS Series Rear View.....	4-3
Figure 4-3 Heratherm OMS Series Front View.....	4-4
Figure 4-4 Heratherm OMS Series Rear View	4-5
Figure 4-5 Sensor Mounting Location - OGS Series and OMS Series.....	4-6
Figure 4-6 Signal Interfaces and Power Socket.....	4-7
Figure 4-7 Shelf System - OGS Series Oven.....	4-8
Figure 4-8 Shelf System - OMS Series Oven.....	4-9
Figure 5-1 Sliding the Retaining Spring into the Support Rail	5-1
Figure 5-2 OGS Series - Installing the Shelving	5-2
Figure 5-3 OMS Series - Installing the Shelving.....	5-2
Figure 5-4 Support Rail Installation.....	5-3
Figure 5-5 Installing the Rear Air Baffle.....	5-4
Figure 5-6 Removing the Bottom Panel.....	5-5
Figure 5-7 Bottom Panel Removed	5-5
Figure 5-8 Removing the Lateral Air Baffle.....	5-6
Figure 5-9 Shelf Support Bracket Installation	5-7
Figure 5-10 Wire-mesh Shelf.....	5-7
Figure 5-11 AC Power Supply Socket.....	5-9
Figure 7-1 Control Panel for Heratherm OGS Series and OMS Series Ovens.....	7-1
Figure 10-1 Door seal replacement (example showing OMH Series oven)	10-3

DOMINIQUE DUTSCHER SAS

Safety Notes

Basic Operating Precautions

These operating instructions describe Heratherm ovens.

Heratherm ovens have been manufactured to the latest state of the art and been tested thoroughly for flawless functioning prior to shipping. However, the oven may present potential hazards, particularly if it is operated by inadequately trained personnel or if it is not used in accordance with the intended purpose. Therefore, the following must be observed for the sake of accident prevention:

- Heratherm ovens must be operated by adequately trained and authorized professional personnel.
- Heratherm ovens must not be operated unless these operating instructions have been fully read and understood.
- The present operating instructions, applicable safety data sheets, plant hygiene guidelines and the corresponding technical rules issued by the operator shall be used to create written procedures targeted at personnel working with the subject matter device, detailing:
 - the safety precautions to be taken when processing specific agents,
 - the measures to be taken in case of accidents.
- Repair work on the oven must be carried out only by trained and authorized expert personnel.
- The contents of these operating instructions are subject to change at any time without further notice.
- Concerning translations into foreign languages, the German version of these operating instructions is binding.
- Keep these operating instructions close to the oven so that safety instructions and important information are always accessible.
- Should you encounter problems that are not detailed adequately in these operating instructions, please contact Thermo Electron LED GmbH immediately for your own safety.

Operational Safety Rules

The following rules must be heeded when working with Heratherm ovens:

- Observe the sample weight limits specified for your Heratherm oven as a whole and its shelving in particular; see “[Technical Data](#)” on page 13-1
- Do not load the bottom of the interior workspace to avoid the risk of overheating any samples placed there.
- Arrange the samples evenly throughout the work space, making sure not to place them too closely to the interior walls to ensure a uniform temperature distribution.
- Do not load your Heratherm oven with substances that exceed the capabilities of the available lab apparatus and Personal Protection Equipment to provide sufficient degrees of protection to users and third parties.
- Check the door seal once a month for proper sealing performance and possible damage.
- Do not process any samples containing hazardous chemical substances that may be released into the ambient air through defective seals or may cause corrosion or other defects on parts of the Heratherm oven.

Warranty





Thermo Electron LED GmbH warrants the operational safety and functions of the Heratherm ovens only under the condition that:

- the oven is operated and serviced exclusively in accordance with its intended purpose and as described in these operating instructions,
- the oven is not modified,
- only original spare parts and accessories that have been approved by Thermo Electron LED GmbH are used (third-party spares without Thermo Electron LED GmbH approval void the limited warranty),
- inspections and maintenance are performed at the specified intervals,
- an installation verification test is performed on commissioning the oven for the first time and repeated after each inspection and repair activity.









The warranty is valid from the date of delivery of the oven to the customer.

Explanation of Safety Information and Symbols

Safety Notes and Symbols Used Throughout These Operating Instructions

	 <p>Indicates a hazardous situation which, if not avoided, will result in death or serious injuries.</p>
	 <p>Indicates a hazardous situation which, if not avoided, could result in death or serious injuries.</p>
	 <p>Indicates a situation which, if not avoided, could result in damage to equipment or property.</p>
	 <p>Is used for useful hints and information regarding the application.</p>

Additional Symbols for Safety Information

	Wear safety gloves!
	Wear safety goggles!
	Harmful liquids!
	Electric shock!
	Hot surfaces!
	Fire hazard!
	Explosion hazard!
	Suffocation hazard!

Symbols on the Oven



Observe operating instructions



VDE test mark



CE-conformity mark: confirms conformity according to EU Guidelines

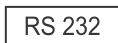

RS 232 interface

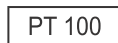

PT 100 Sample Sensor - accessory part



Alarm contact

Intended Purpose of the Oven

Correct Use

Heratherm ovens are laboratory devices for heating applications, equipped with precision temperature control.

They are designed for heat treating samples or materials at operating temperatures between 50 °C (122 °F) and 250 °C (482 °F) , including - for example, drying, ageing, analyzing, decomposing, burn-in, oxidizing, reducing, and preheating.

Heratherm ovens have been designed for installation and operation in the following environments:

- heat treatment in a reduced or modified atmosphere;
- drying of material.

Incorrect Use

To avoid the risk of explosion do not load the oven with tissue, material, or liquids that:

- are easily flammable or explosive;
- release vapor or dust that forms combustible or explosive mixtures when exposed to air;
- release poisons;
- create a humid atmosphere;
- release dust;
- exhibit exothermic reactions;
- are pyrotechnical substances;
- exceed the specified hurdle load.

Standards and Directives

The oven complies with the following standards and guidelines:

- IEC EN 61010 - 1, IEC EN 61010 - 2 - 010
- Low Voltage Directive 2006/95/EC
- EMC Directive 2004/108/EC

Additionally, the oven is in compliance with many other international standards, regulations and directives not listed here. Should you have any questions regarding compliance with national standards, regulations and directives applicable for your country, please contact your Thermo Fisher Scientific sales organization.

Delivery of the Oven

Packaging

Heratherm ovens are delivered in a rugged packaging box. All packaging materials can be separated and are reusable:

Packaging materials

Packaging carton: Recycled paper

Foam elements: Styrofoam (CFC-free)

Pallet: Chemically untreated wood

Packaging film: Polyethylene

Packaging ribbons: Polypropylene

Acceptance Inspection

After the oven has been delivered, check the delivery immediately for:

- completeness,
- possible damage.

If components are missing or damage is found on the oven or the packaging, in particular damage caused by humidity and/or water, please notify the carrier as well as Technical Support immediately.



Risk of injury

Should sharp edges have formed in damaged areas or elsewhere on the device, take all necessary precautions to protect personnel handling the oven. For example, have them wear protective gloves and other personal protection equipment.

Scope of Supply

Ovens

Quantity of components supplied (pieces)	OGS Series	OMS Series
Wire-mesh shelf	2	2
Support rail for shelf	0	2
Shelf support brackets	4	4
Power cord	1	1
Clip springs	0	2
Operating manual	1	1
Short reference guide	1	1

Installation

Ambient Conditions

The oven must only be operated in a location that meets all of the ambient condition requirements listed below:

Location Requirements

- Draft-free and dry indoor location.
- Dust loading should be in keeping with the degree of contamination, which is Pollution Degree 2 according to IEC EN 61010-1. Using the oven in an atmosphere with electrically conductive dust is prohibited.
- The minimal distance to adjacent surfaces must be observed on all sides (see section “Space Requirements” on page 3-3).
- The operating room must be equipped with appropriate ventilation.
- Solid, level, fire-proof surface and no flammable materials opposite to the rear panel of the oven.
- Vibration-proof substructure (floor stand, lab table) capable of bearing the dead weight of the oven and its accessories (particularly if two devices are stacked).
- The ovens have been designed for an operating height of up to 2000 m above sea level.
- Ambient temperature range from 18 °C to 32 °C / 64.4° F to 89.6° F.
- Relative humidity up to 80% (maximum; preferably 60-70%), non condensing.
- Should condensation exist, wait until the moisture has evaporated completely before connecting the oven to a power source and powering up.
- Avoid direct exposure to sunlight.
- Devices that produce excessive amounts of heat must not be placed near the oven.
- To avoid drying operation without an appropriate fresh air supply make sure that the air inlet (which may be equipped with an optional fresh air filter) is not obstructed or blocked by any adjacent objects.
- Power line voltage variations must not exceed ± 10 % of the nominal voltage.
- Transient overvoltages must not exceed the values usually encountered throughout the power supply network. The nominal transient overvoltage level shall be the surge withstand voltage according to overvoltage category II of IEC 60364-4-443.

- Place the oven on a floor stand (option; to be ordered separately), never on the lab floor.
- Consider installing one dedicated upstream circuit breaker per oven to avoid multiple device failures in case of an electrical fault.

Intermediate Storage

When the oven is placed in intermediate storage, which is permissible for a maximum of four weeks, make sure that the ambient temperature is between 20°C to 60°C (68°F to 140°F) and the maximum relative humidity does not exceed 90%, non-condensing.

Room Ventilation

Heat dissipating from the oven during continuous operation may cause a change in the room climate.

Therefore, the oven must only be installed in rooms with sufficient ventilation.

Do not install the oven in room recesses without ventilation.

When several devices are to be placed in the same room, additional ventilation may have to be provided as necessary.

To avoid any impact of the heat dissipated by the oven on the ambient climate the room must be vented by means of a laboratory-grade ventilation system that complies with applicable local and national health and safety regulations and has sufficient capacity.

If excessive temperatures tend to occur in the operating room, be sure to provide a thermal protection means that cuts out the power supply to mitigate the impact of overtemperature scenarios.

Use with Air Exhaust Systems

When the oven is connected to an air exhaust system be sure to adjust its air flow so the temperature distribution pattern throughout the oven's workspace remains unchanged and precision temperature control is maintained.

Also, be sure to interlock the oven and its exhaust system so both start and run at the same time. The oven may be unable to overcome the extra flow resistance introduced by the idle air exhaust system, which may cause the exhaust air to be vented into the surrounding lab room.

Before using existing piping in the building to exhaust hot air from the oven, be sure that such exhaust piping is made of heat-resistant material, so it will not overheat, melt and/or cause a fire.

The oven's outer surfaces and its air exhaust piping may become hot, so be sure to maintain the proper spacing from walls and ceilings specified by local building codes and/or fire protection regulations.

Mark hot exhaust air piping with appropriate hot surface warning signs or restrict access to such piping altogether to avoid the risk of injury through contact with hot surfaces.

Space Requirements

When installing the oven, make sure that the installation and supply connections remain freely accessible.

The specified side clearances represent minimum distances.

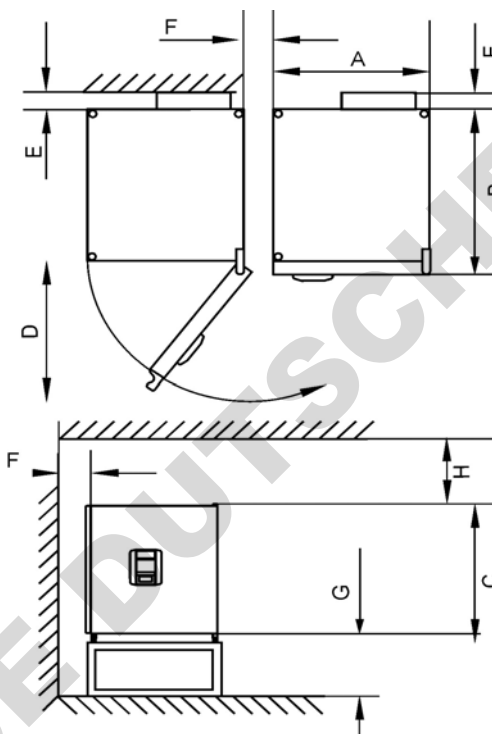

Figure 3-1 Oven Dimensions and Required Clearance

Table 3-1 Heratherm Oven Dimensions

Type	A (mm/inch [*])	B (mm/inch)	C (mm/inch)	D (mm/inch)
OGS 60 / OMS 60	530 / 20.8	565 / 25.2	720 / 28.3	540 / 21.3
OGS 100 / OMS 100	640 / 25.2	565 / 25.2	820 / 32.3	650 / 25.6
OGS 180 / OMS 180	640 / 25.2	738 / 29.1	920 / 36.2	650 / 25.6

*Dimensions in inches are rounded equivalents specified for information only. Depth of handle /display (66 mm/2.6 in) not included in overall depth specified; height of adjustable feet (36 mm/1.4 in) not included in overall height specified.

Table 3-2 Required Clearances

E (mm/inch)	F (mm/inch)	G (mm/inch)	H (mm)
80 / 3.2	50 / 2	300 / 12	300 / 12

Transport

For transport, do not lift the oven using the doors or components attached to the oven as lift points.

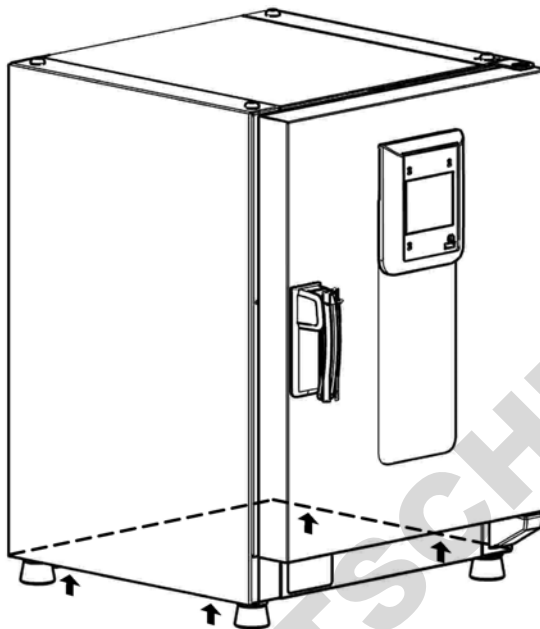



Figure 3-2 Lift Points

	<p> CAUTION Heavy loads! Lift with care!</p> <p>To avoid injury through physical strain, such as strain traumata and slipped discs, do not attempt to lift the oven alone!</p> <p>To avoid injury through dropped loads, be sure to wear Personal Protection Equipment, such as safety shoes, when lifting the oven.</p> <p>To avoid crushing your fingers or hands (particularly in a closing door) or damaging the oven, do not use any other lift points than those indicated in the illustration above.</p>
--	---

Stacking Kit

Material Number	Description
50126665	Stacking adapter Heratherm 60L
50126666	Stacking adapter Heratherm 100L
50126667	Stacking adapter Heratherm 180L

Scope of Delivery

- 1 stacking adapter
- 1 anti-tilt anchor
- 1 plastic bag with 2 stacking feet and 2 M4x16 Torx screws.

Required Tools

- Slotted screwdriver 5,5x100 or Torx screwdriver 20x100.

Installing the Stacking Feet

1. Remove the left and right blank plugs at the top blank.
2. Install the stacking feet with the enclosed screws using a slotted or Torx screwdriver.

Installing the Stacking Adapter

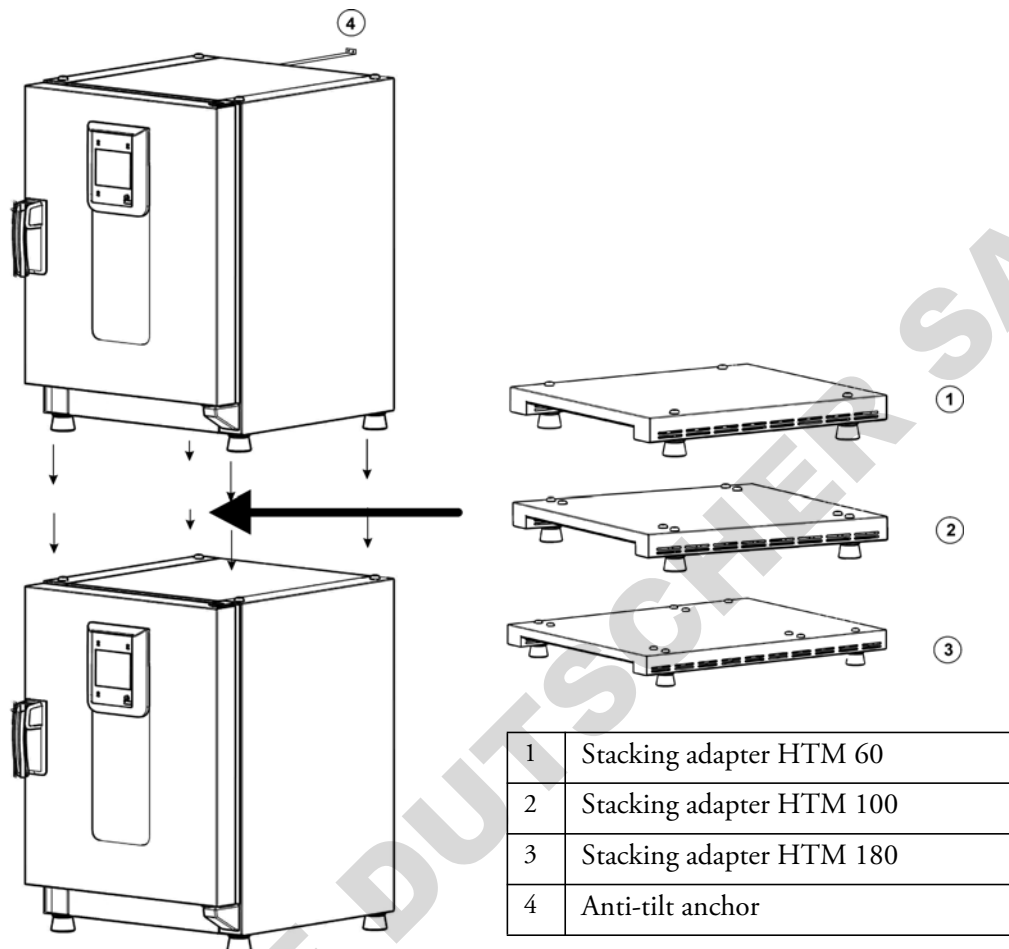

Stack as follows when using a stacking adapter (numbers denote oven volumes in liters):

- for 60/100/180 on 180 use stacking adapter Heratherm 180L,
- for 60/100 on 100 use stacking adapter Heratherm100L,
- for 60 on 60 use stacking adapter Heratherm 60L.

To prevent the top oven from slipping and dropping down, the following requirements must be fulfilled before devices may be stacked:

- Only two units may be stacked together. When stacking devices with the same type of enclosure, yet with a different footprint the device with the smaller footprint must be placed on top of the one with the larger footprint at all times.
- The bottom device must be correctly levelled.
- Be sure to use the appropriate stacking adapter.
- The levelling feet on the top device must be screwed in all the way.
- The levelling feet of the top device must be aligned with and placed exactly on the stacking pads of the stacking adapter.

- The anti-tilt anchor must be installed on the top device.

Installing the Anti-tilt Anchor

The anti-tilt anchor secures the top device in a stack to a solid part of a building. The anti-tilt anchor is to be mounted on the side opposite of the door hinges.

Bend the fixing tabs of the anti-tilt anchor up on one side and down on the other by an angle of approx. 90°.

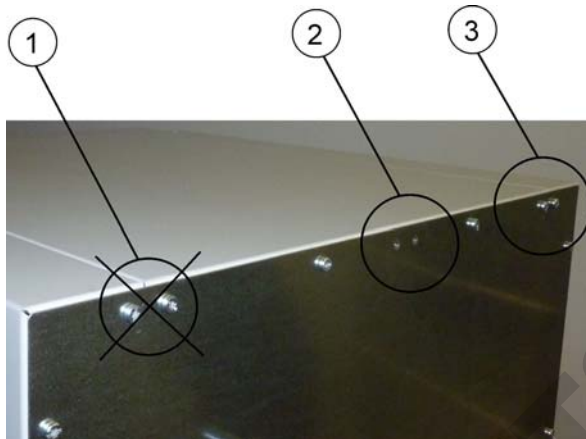

1. Do not use this position if the door is hinged on this side. Right-hand hinges represent the standard configuration.
2. Preferred position.
3. Alternative position. Do not use if the door is hinged on this side.

Remove the bracket screws. Use the preferred position, if possible.

Fix the anti-tilt anchor with the bracket side down to the unit.

Position the unit with the anti-tilt anchor to in an angle of approx. 90° +/- 20%.

Take care that the stacking feet of the unit are still in correct place on the lower unit or on the stacking adapter.

Fix the anti-tilt anchor to a solid part of the building.



Unsafe part of the building!

Install the anti-tilt anchor to a solid part of the building, which is able for shoring loads.

The installation has to be carried out by qualified personnel only.

The connection to the building must be carried out with appropriate screws and dowels according to the consistence of the building part.

Additionally, the following caution notes must be heeded at all times:



Risk of overheating with stacked devices

To avoid the risk of electrical components and the outer enclosure overheating or temperature control failing due to insufficient ventilation, do not exceed the specified stacking height!



Risk of tipping and dropping of stacked devices

You should be aware at all times that stacked devices do not form a stable unit, even when the stacking pads and frames are used correctly. The top device may tip over and drop down when being transported in a stack. To avoid injury to persons and damage to equipment, do not attempt to move stacked devices as a unit! Separate and move each device one by one, then restack them.

NOTE

Condensation forming while operating stacked devices

If stacked devices are operated at an ambient temperature of more than 26 °C (79 °F), temperature control may be adversely affected on the top device while the decontamination routine is running on the bottom device. To prevent any impairment of temperature control, make sure that the space between and around any two stacked devices is well-ventilated for optimum heat removal.

Product Description

This section describes Heratherm general protocol ovens for standard laboratory applications, which are available in two versions distinguished by convection method:

- Heratherm OGS Series general protocol natural convection ovens (see “[Heratherm OGS Series Oven Overview](#)” on page 4-1)
- Heratherm OMS Series general protocol mechanical convection ovens (see “[Heratherm OMS Series Oven Overview](#)” on page 4-3)

Heratherm OGS Series Oven Overview

Heratherm OGS Series (OGS is brief for Oven with Gavity convection for Standard laboratory applications) general protocol natural convection ovens come equipped with the following features:

- high-precision work space temperature control, adjustable in steps one degree up to 250 °C/482 °F;
- a mechanically-operated damper for venting the work space, equipped with an external slider rotary button control;
- a countdown timer for timed process control;
- two wire-mesh shelves;

The individual features of ovens are shown in [Figure 4-1](#) and [Figure 4-2](#) below.

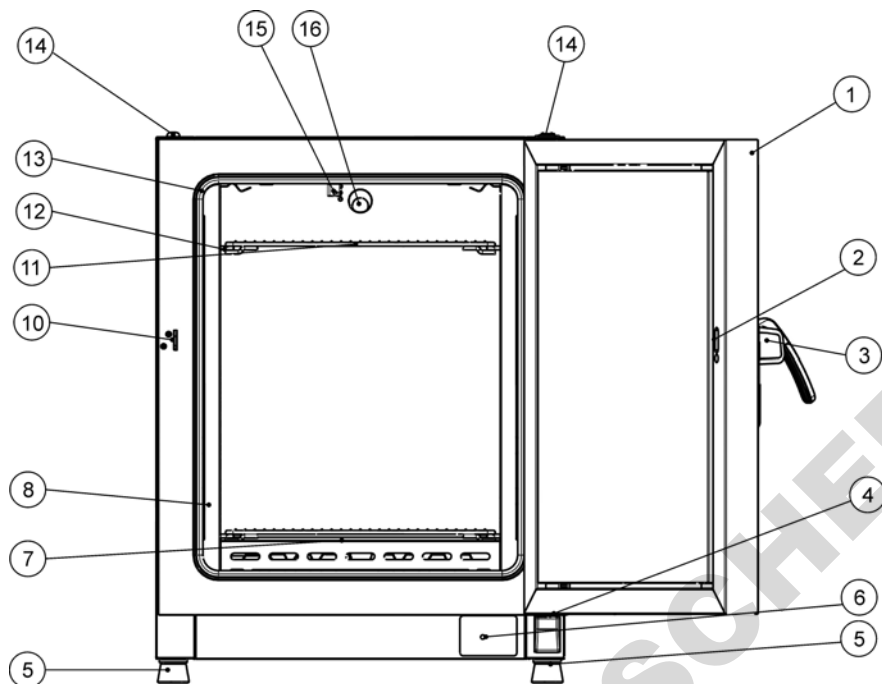

Figure 4-1 Heratherm OGS Series Front View

- [1] Outer door
- [2] Door latch cut-out
- [3] Door latch and handle
- [4] Door hinge, lower
- [5] Levelling foot
- [6] Nameplate
- [7] Air baffle, bottom
- [8] Air baffle, side
- [9] -
- [10] Door hook catch
- [11] Wire-mesh shelf
- [12] Support rail for wire-mesh shelf
- [13] Door seal
- [14] Stacking pad
- [15] Temperature sensor
- [16] Exhaust air tube

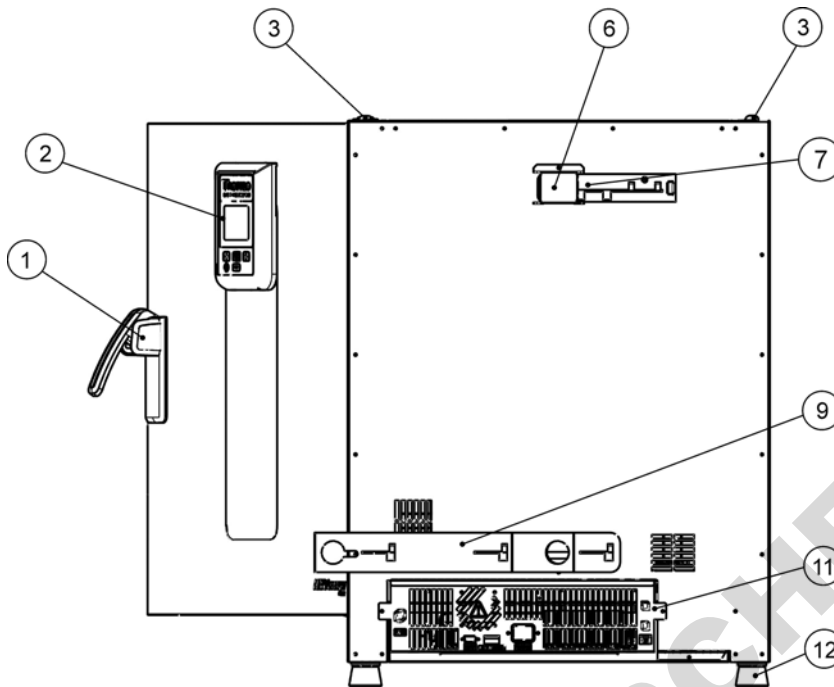

Figure 4-2 Heratherm OGS Series Rear View

- [1] Door latch and handle
- [2] Control panel
- [3] Stacking pad
- [4] -
- [5] -
- [6] Spacer
- [7] Air outlet aperture
- [8] -
- [9] Air inlet, mechanical
- [10] -
- [11] Electronics compartment
- [12] Levelling foot

-Heratherm OMS Series Oven Overview

Heratherm OMS Series (OMS is brief for Oven with Mechanical convection for Standard laboratory applications) general protocol fan convection ovens come equipped with the following features:

- high-precision work space temperature control, adjustable in steps of one degree up to 250 °C/482 °F;
- a fixed-speed fan for optimizing temperature uniformity throughout the work space;
- a mechanically-operated damper for venting the work space, equipped with an external rotary button control;
- a countdown timer for timed process control;
- two wire-mesh shelves.

Product Description
-Heratherm OMS Series Oven Overview

The individual features of OMS Series ovens are shown in [Figure 4-3](#) and [Figure 4-4](#) below.

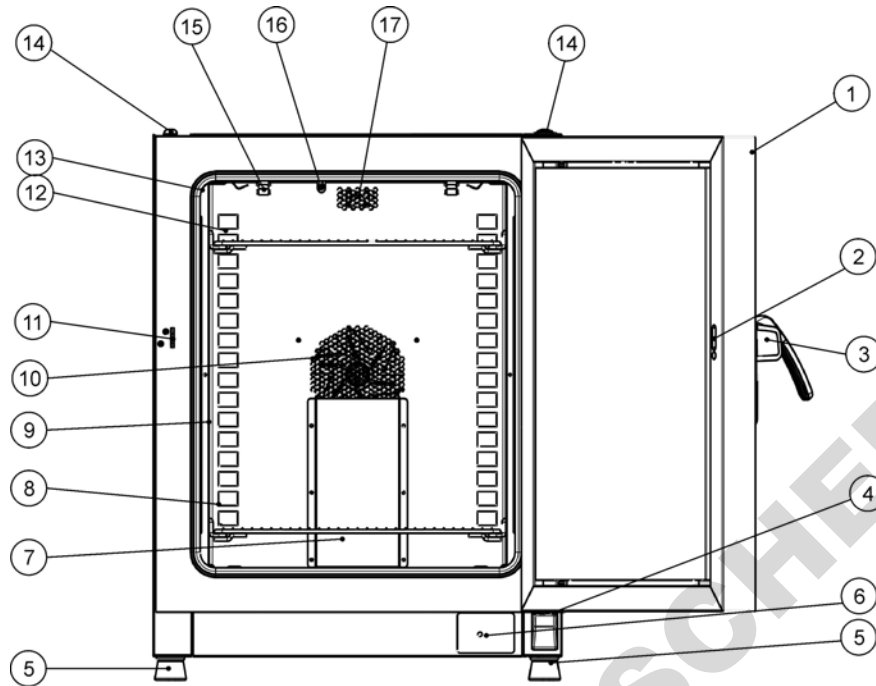

Figure 4-3 Heratherm OMS Series Front View

- [1] Outer door
- [2] Door latch cutout
- [3] Door latch and handle
- [4] Door hinge, lower
- [5] Levelling foot
- [6] Nameplate
- [7] Air baffle, top piece
- [8] Support rail for wire-mesh shelf
- [9] Shelf rack
- [10] Fan cover, integrated into air baffle
- [11] Door hook catch
- [12] Air baffle
- [13] Door seal
- [14] Stacking pad
- [15] Spring for air baffle
- [16] Temperature sensor
- [17] Exhaust air tube

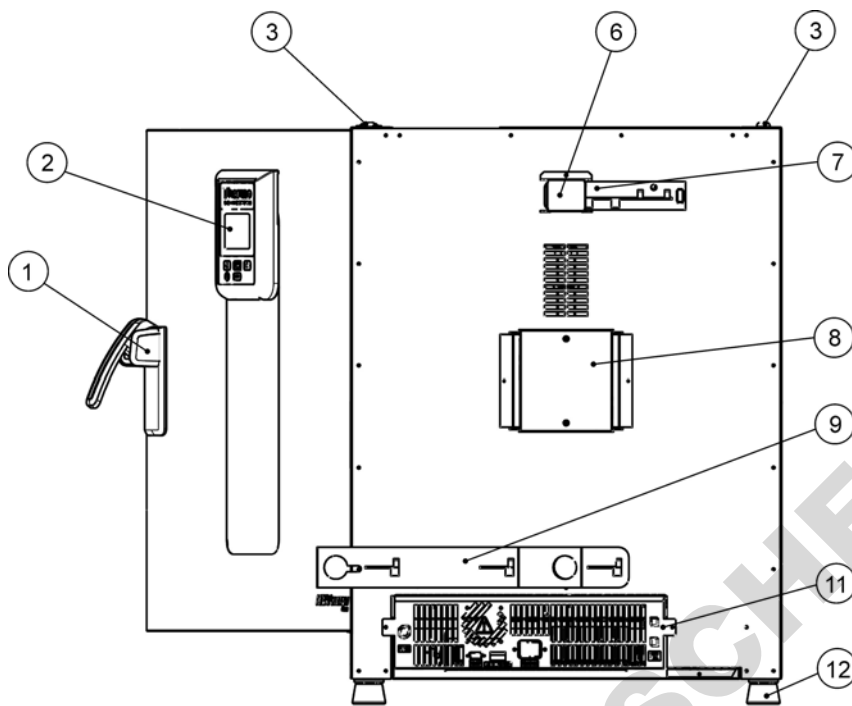

Figure 4-4 Heratherm OMS Series Rear View

- [1] Door latch and handle
- [2] Control panel
- [3] Stacking pad
- [4] -
- [5] -
- [6] Spacer
- [7] -
- [8] Electronics compartment
- [9] Levelling foot

DOMINIQUE DUTSCHER SAS

Safety Devices

The oven is equipped with the following safety features:

- a sample protection feature that safeguards the samples against destruction through overheating in case of controller failure;
- an overheat protection cut-out feature that shuts down the oven completely when excessive temperatures occur in the workspace;
- dual fuses rated at 16 amperes.

Operating Environment

To ensure undisturbed operation, the ambient temperature in the operating room must be at least 18 °C (64.4 °F). The heating system controls the temperature in the oven's workspace of 50 °C/122 °F up to the maximum of 250 °C/482 °F .

Sensing and Control System

The PT 100-type sensor for the control of the work space temperature and for the thermal protection [1] is mounted in the top panel of the work space compartment.

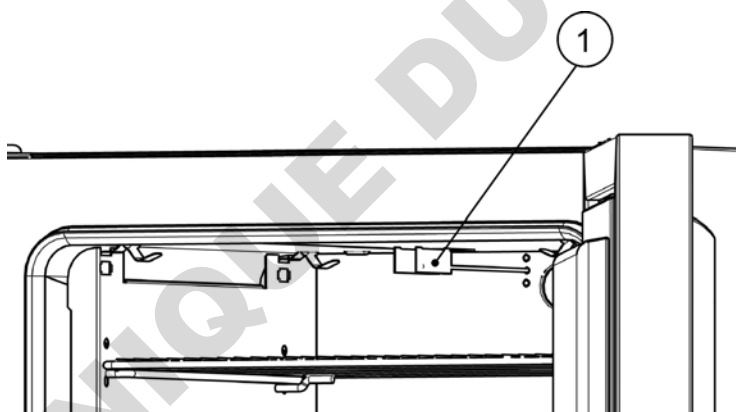

Figure 4-5 Sensor Mounting Location - OGS Series and OMS Series

The work space temperature sensor provides the inputs to the oven's built-in controller, which continuously compares the measured values to the user-specified set value and adjusts the heaters according to the result.

The unit features a thermal protection function that is factory-preprogrammed and not adjustable. It protects the samples in the work space from overheating: Thermal protection kicks in on a brief violation of the upper limit, based on the user-selected temperature set value, automatically reducing the work space temperature to the user-specified set value and allowing the heating process to continue even in case of a controller malfunction. If the thermal protection is activated, the error message (E111) "Temperature too high" appears in the display window and an audible alarm is sounded.

When the user acknowledges the error message, the red alarm icon (D3 in [Figure 7-1](#) on [page 7-1](#)) is illuminated and the Temperature Set Value icon (see [Table 7-3](#) on [page 7-3](#)) is highlighted by a red border to indicate that thermal protection has kicked in.

Data Communications & Alarm Interface

All signal connections are installed in the electrical interface panel at the rear of the oven.

RS-232 Interface

The RS-232 interface (left in [Figure 4-6](#) below) may be used to connect ovens to the serial interface port of a computer to allow for the computer-aided acquisition and documentation of major operating parameters (temperature, error codes, etc.).



Figure 4-6 Signal Interfaces and Power Socket

AC Power Socket

The oven is connected to the AC supply mains via the socket at right in [Figure 4-6](#) above, which accepts a power cord with an IEC standard plug [9].

Fuses

Two 16 A slow-blow fuses mounted on the oven's main electronic circuit board protect internal circuitry from the impact of excessive power consumption.

NOTE

Fuse replacement

The device fuses are not user-serviceable. When the oven exhibits the typical signs of a blown fuse (no response to pressing the On/Off button, control panel remains extinguished, no heating operation), call Customer Service to have the fuses replaced.

Work Space Components

Inner Chamber

All components of the work space are made of corrosion-resistant galvanized steel and have an absolutely smooth and easy-to-clean surface. Any embossings have a large radius.

Shelf System

The oven is supplied with two wire-mesh shelves. The shelf support rails have an alternating pattern of oblong and round perforations spaced evenly at 30 mm, allowing the shelf support brackets to be inserted without any room for error, yet in a very flexible way to accommodate different heights of sample containers. The shelves have an integrated tilt protection and withdrawal stop. For details on using the shelf system, see the section “Start-up” on page 5-1.

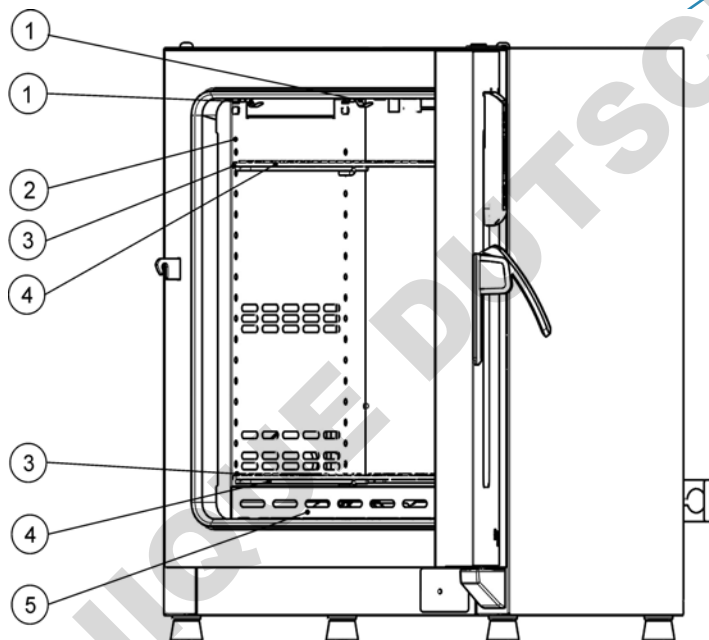

- [1] Retaining spring
- [2] Air baffle, lateral
- [3] Support rails
- [4] Wire-mesh shelf
- [5] Air baffle, bottom

Figure 4-7 Shelf System - OGS Series Oven

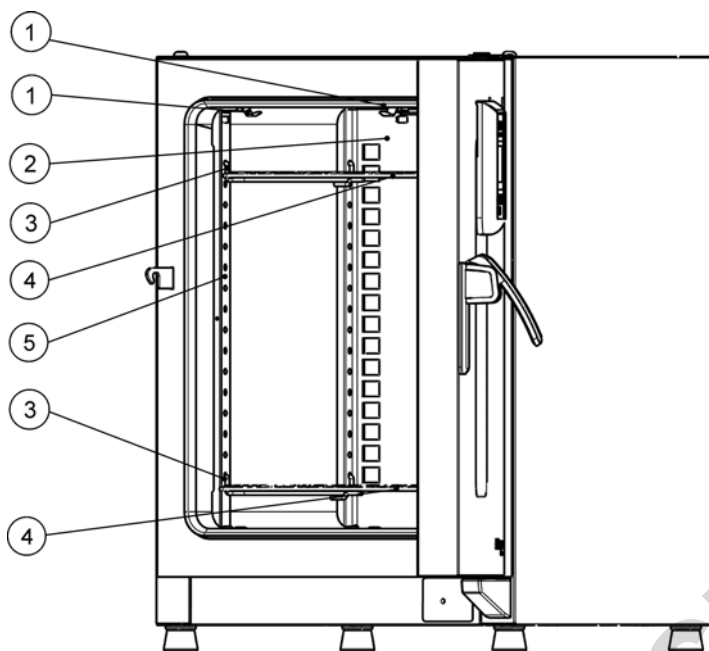

- [1] Retaining spring
- [2] Air baffle, lateral
- [3] Shelf support brackets
- [4] Wire-mesh shelf
- [5] Support Rail

Figure 4-8 Shelf System - OMS Series Oven

[6]

tube access porttube access porttube access port

DOMINIQUE DUTSCHER SAS

DOMINIQUE DUTSCHER SAS

Start-up

Installing the Shelf System

The installation of the shelf system does not require any tools. The support rails are secured in place by spring action. Once the shelf support brackets have been inserted into the rails, the wire-meshshelves can be simply pushed onto their support hooks to complete the installation.

Initial installation

Heratherm OGS Series ovens have the shelving support rails integrated with the air baffles, which are readily pre-installed when the devices are shipped from the factory.

Heratherm OMS Series ovens come with separate support rails, which need to be installed as follows:

1. Peel off the protective foil from the support rails.
2. Push the retaining spring [1] into the guide on the support rail [2], making sure that the locking nub [3] on the retaining spring safely engages with the matching hole in the support rail.

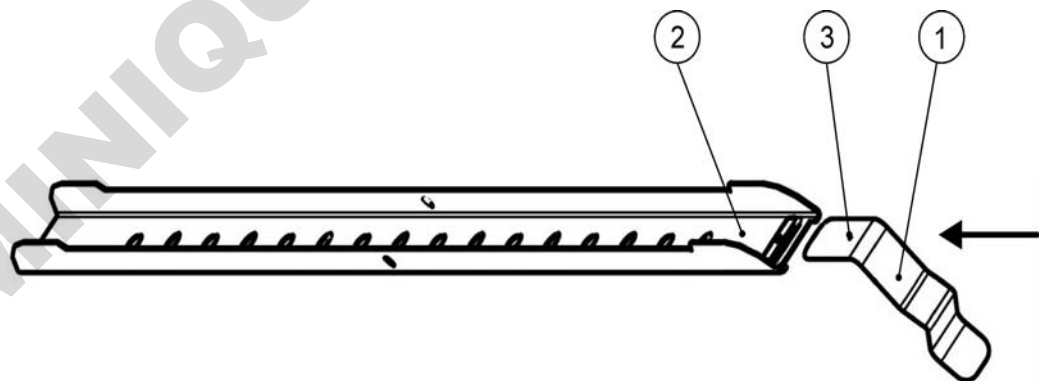
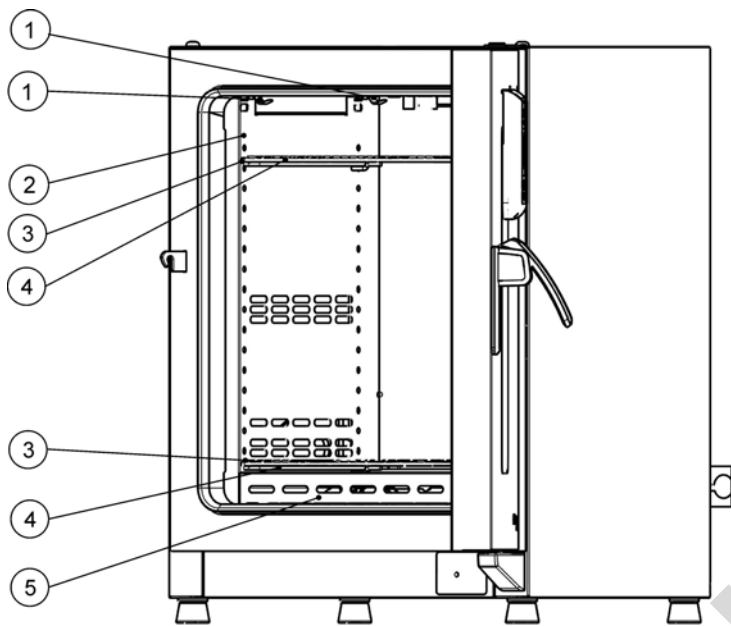

Figure 5-1 Sliding the Retaining Spring into the Support Rail

Installing the Shelving

The illustrations below show the placement of the shelf system elements.



- [1] Retaining spring
- [2] Air baffle, lateral
- [3] Support rails
- [4] Wire-mesh shelf
- [5] Air baffle, bottom

Figure 5-2 OGS Series - Installing the Shelving

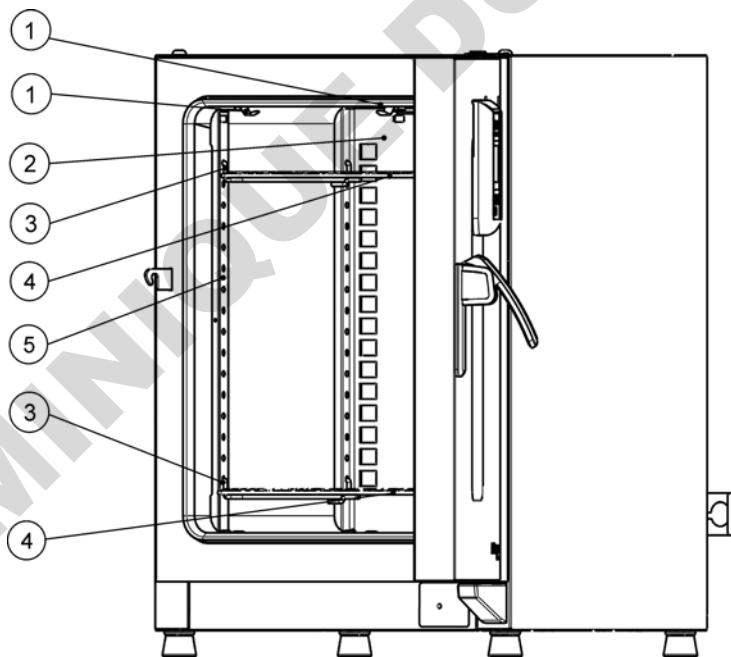

- [1] Retaining spring
- [2] Air baffle, rear
- [3] Shelf support brackets
- [4] Wire-mesh shelf
- [5] Support Rail

Figure 5-3 OMS Series - Installing the Shelving

Preparing the Work Space

The following work space components should be checked for cleanliness and cleaned prior to use:

- shelf support brackets,
- wire-mesh shelves,
- work space surfaces,
- work space seals and gaskets,

NOTE	Disinfection For details about the cleaning of the oven, please refer to the section “Cleaning” on page 9-1.
-------------	--

Installation or Removal of the Support Rails (OMS Series only)

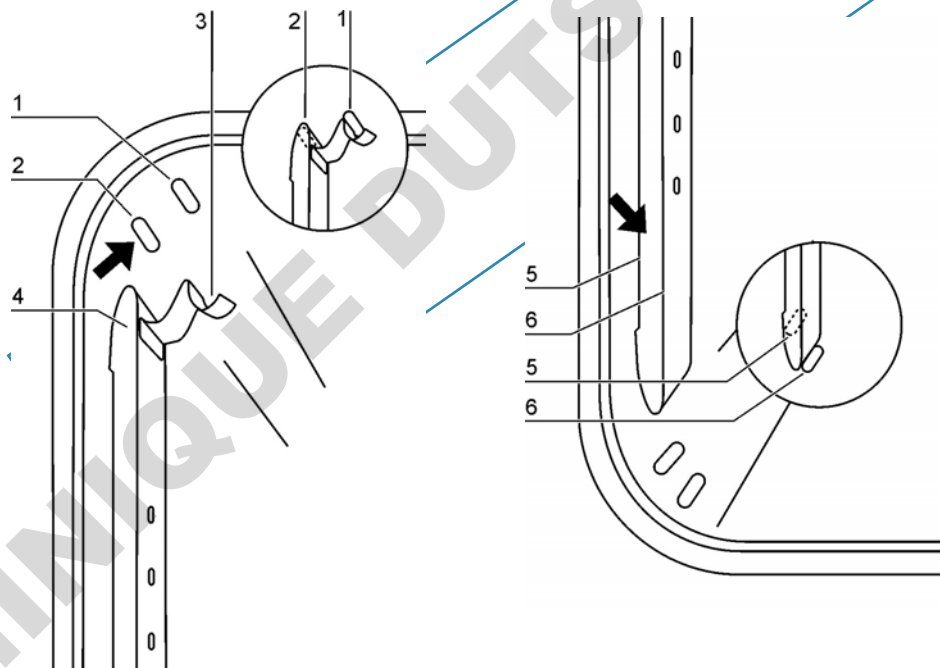

Figure 5-4 Support Rail Installation

The embossings at [2] and [5] act as lateral guides for the support rails, while the embossings at [1] and [6] secure the support rails in place. For the support rails to install correctly the retaining spring [3] must be facing upwards.

1. Place the support rail [4] on the lower embossing [6] and tilt it upwards against the work space side wall so that the rail is positioned over the two embossings at [5] and [2].
2. Clamp the retaining spring [3] behind the upper embossing [1].

3. To remove the support rails, pull the retaining spring tab down out of the embossing and remove the support rail assembly.

Installing and Uninstalling the Rear Air Baffle (OMS Series only)

Heratherm OMS Series ovens are shipped from the factory with an air baffle readily pre-installed at the back wall of the work space (while OGS Series ovens do not have this feature). Before the air baffle can be removed from the back wall, the support rails need to be uninstalled as explained further above.

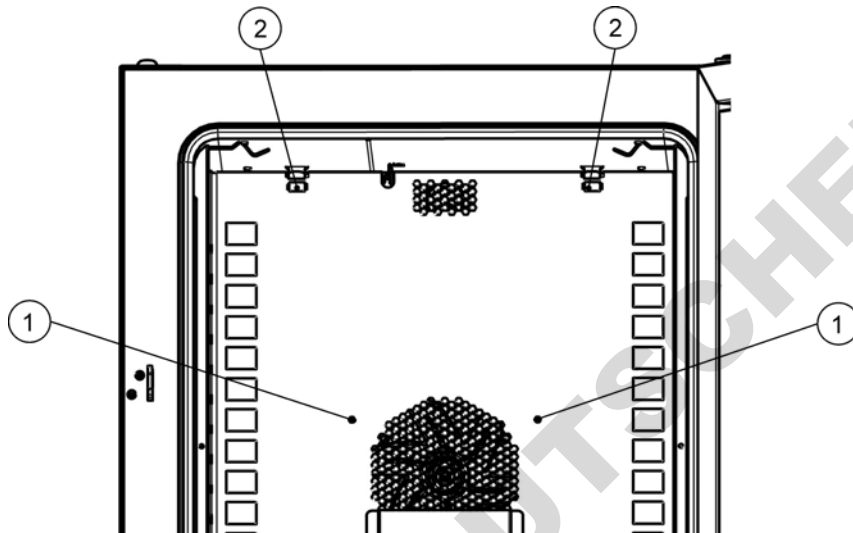

Figure 5-5 Installing the Rear Air Baffle

1. Loosen the two screws [1] that hold the air baffle to the back wall of the work space.

	WARNING	Risk of damage to sensor!
To prevent accidental damage, be sure to avoid collision with the sensor when installing or uninstalling panels in the oven's workspace.		

2. Grab the two retaining springs [2] at their tabs and pull them downwards out of the embossings, then pull off the rear air baffle.
3. For the rear air baffle to install correctly, the two retaining springs [2] must be facing upwards. Place the air baffle on the lower embossings and tilt it upwards against the back wall of the work space.
4. Clamp the two retaining springs [2] into the upper embossings.
5. Secure the air baffle to the work space back wall by fastening the two screws at [1].

Installing and Uninstalling the Lateral Air Baffles (OGS Series only)

The following section describes the installation and removal of the lateral air baffles.

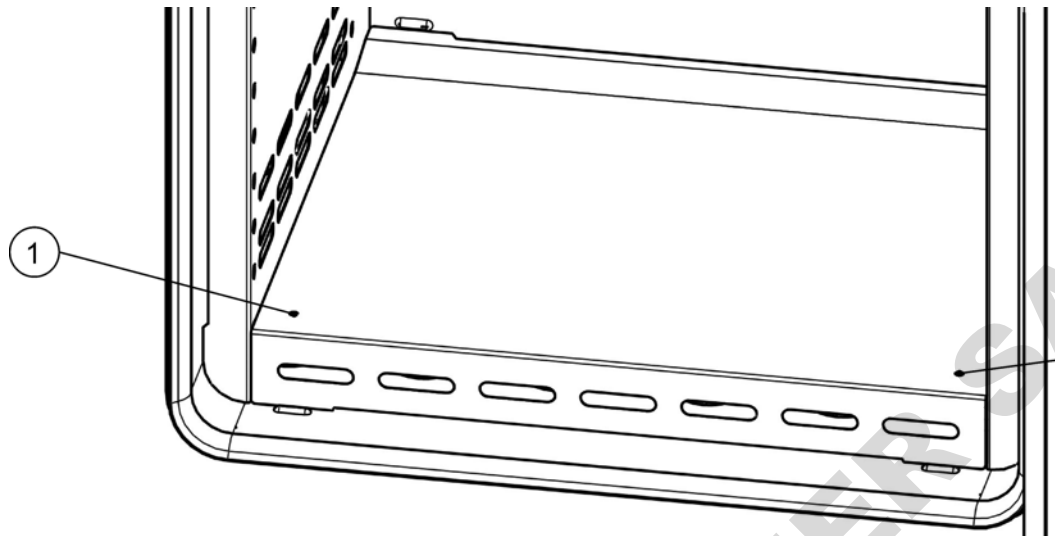

Figure 5-6 Removing the Bottom Panel

1. Loosen the two screws [1] in the bottom panel, then remove the entire bottom panel by lifting it out of its two embossings.

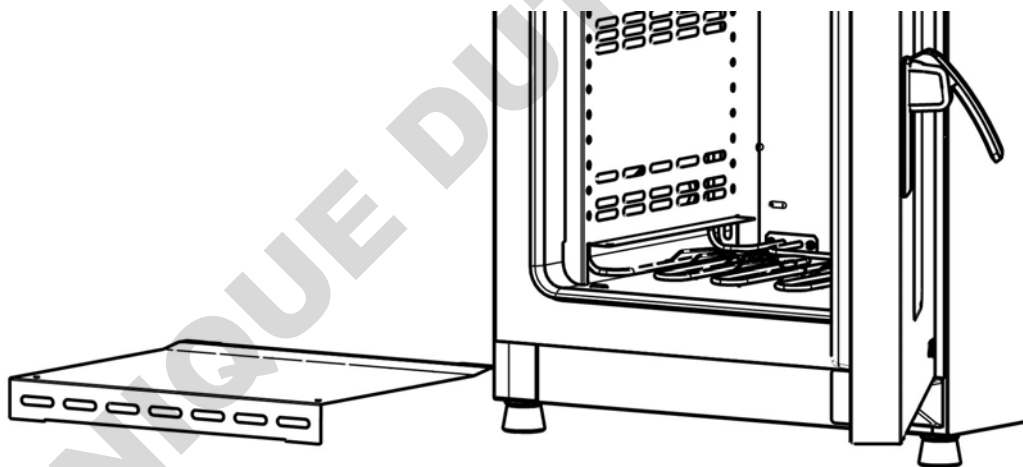

Figure 5-7 Bottom Panel Removed

2. Grab the two retaining springs [1] at their tabs and pull them downwards out of the embossings, then pull off the lateral air baffle.



WARNING

Risk of damage to sensor!

To prevent accidental damage, be sure to avoid collision with the sensor when installing or uninstalling panels in the oven's workspace.

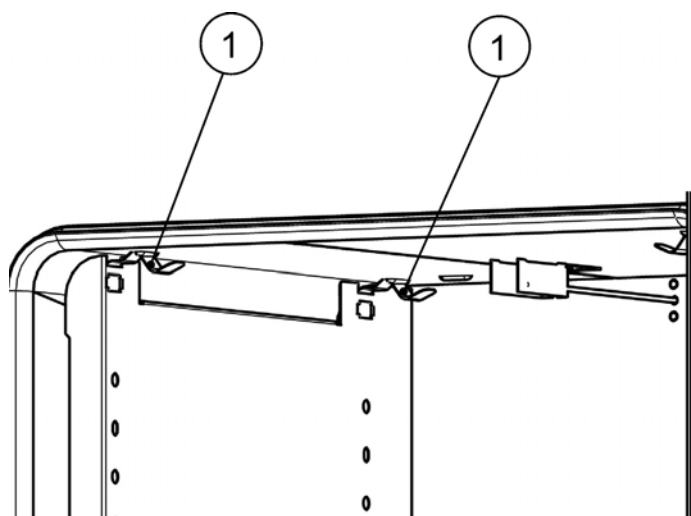

Figure 5-8 Removing the Lateral Air Baffle

3. For the lateral air baffles to install correctly, the two retaining springs [1] must be facing upwards. Place the lateral air baffle on the lower embossings and tilt it upwards against the side wall of the work space.
4. Clamp the two retaining springs [1] into the upper embossings.
5. Replace the bottom panel into the embossings and secure it by fastening the two screws at [1].

Installing the Shelf Support Brackets

1. Insert the shelf support brackets [3] into the perforations [1] of the support rail and air baffle and tilt them downwards.

NOTE	Horizontal position of support rails
Please note the alternating sequence of round and oblong holes. Be sure to use the correct pair of opposite holes, so the support rails are truly horizontal.	

2. Make sure that the two vertical elements [2] of the shelf support bracket butt against the support rail and air baffle.

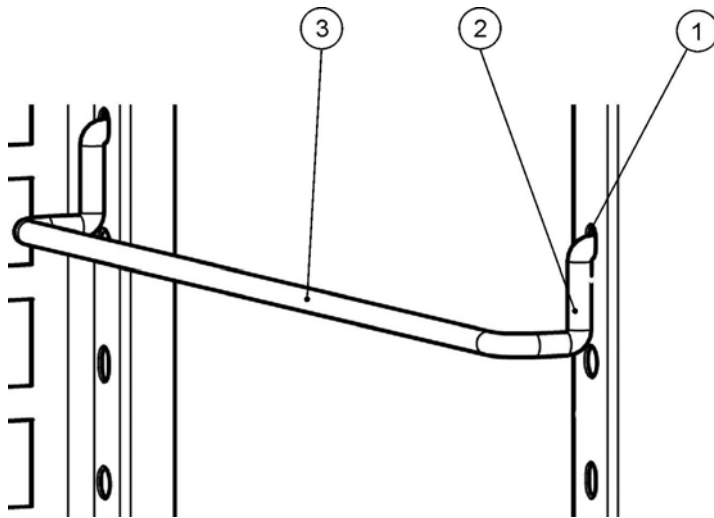

Figure 5-9 Shelf Support Bracket Installation

Installing the Wire-mesh Shelves

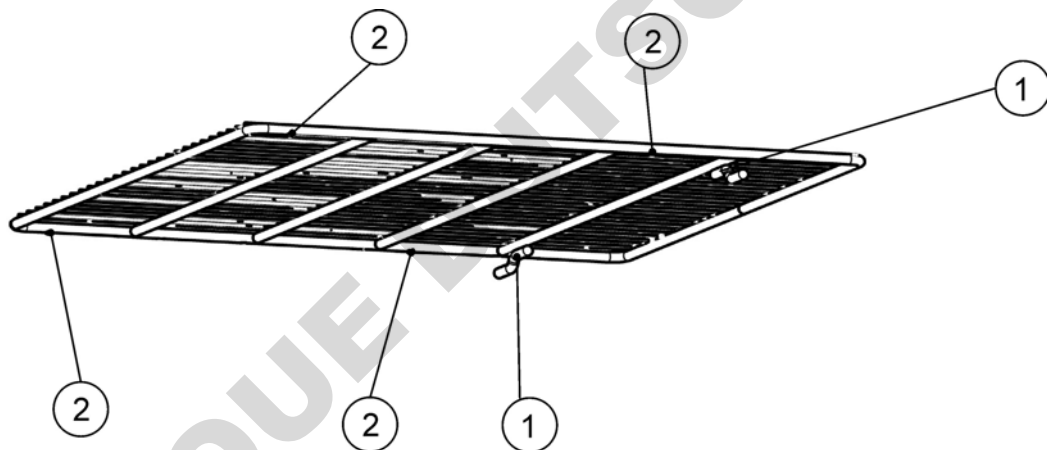

Figure 5-10 Wire-mesh Shelf

1. Push the wire-mesh shelf onto the shelf support brackets with the tilt protection devices [1] facing the rear panel of the oven. The tilt protection devices [1] also serve as guides for the wire-mesh shelves.
2. Slightly raise the wire-mesh shelf so that the pull-out stops [2] can slide over the shelf support brackets.
3. Make sure that the shelves and both of their tilt protection devices are free to move over the shelf support brackets.

Levelling the Oven

1. Position a bubble level onto the center shelf.

2. Manually adjust the levelling feet until the wire-mesh shelf is horizontally aligned in all directions. Perform the adjustment of the levelling feet from left to right and from rear to front.

Connecting Power

	 DANGER	Electric shock
<p>Contact with live electrical components may cause a lethal electric shock. Before connecting the oven to the power supply, check the power cord and the plug for damage. Do not use damaged cables for connecting the oven to the power supply!</p>		

The oven has a class I, protection-earthed enclosure. To minimize the risk of electrical shock, use the AC power cord supplied to connect the oven to a correctly installed and protection-earthed power supply source, with the following features in place for each oven:

- T 16 A slow-blow fusing
- B 16 circuit breaker

 NOTE	Benefits of using separate electrical feeders
<p>Although several devices may be operated on the same electrical feeder if the rated current is not exceeded, we strongly recommended to provide one feeder with a dedicated upstream circuit breaker per oven to avoid the failure of multiple devices in case of an electrical fault.</p>	

Connection to the Power Supply Source

1. Before connecting the oven to the power source, check to see if the power supply voltage corresponds with the specifications on the nameplate on the front of the oven. If the voltage (V) and current (A) ratings given are not as required, do not connect the oven to the power source!
2. Connect the IEC connector to the socket at the rear of the oven.
3. Route the power cord along a path that does not cross exhaust air piping or passageways and aisles.
With stacked devices, keep the power cord away from hot spots on the other oven in the stack.
4. Connect the protection-earthed plug of the power cord to a correctly protection-earthed and earth leakage circuit breaker fused power socket.
5. Make sure the power cord is not subjected to tensile or compressive force.

<div style="background-color: #0056b3; color: white; padding: 5px; display: inline-block;">NOTE</div>	<p>Power outlets</p> <p>Make sure that power outlets remain freely accessible at all times!</p>
--	--

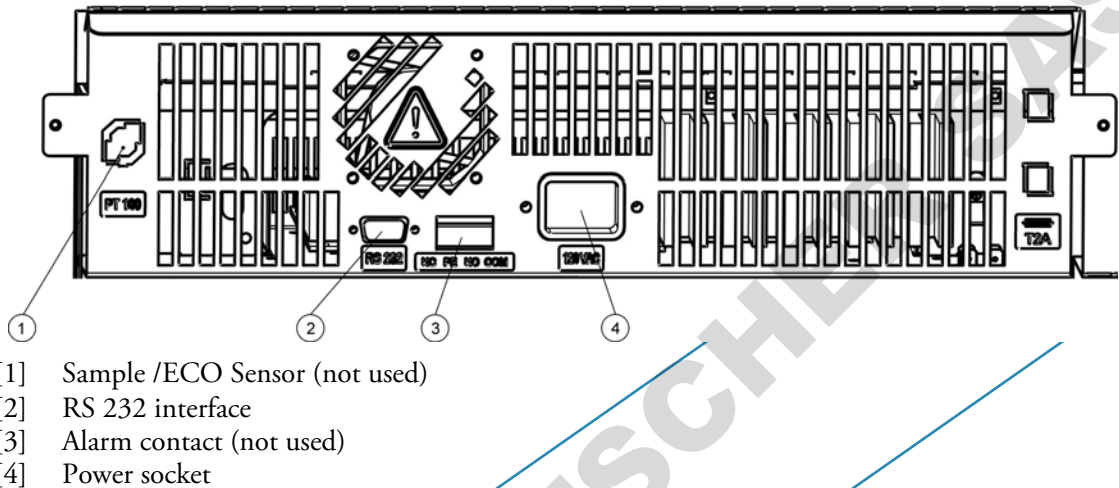

Figure 5-11 AC Power Supply Socket

<div style="background-color: #0056b3; color: white; padding: 5px; display: inline-block;">NOTE</div>	<p>Condensation</p> <p>When taking the oven into operation for the first time allow some time for stabilization before switching on to avoid condensation forming on live parts.</p>
--	---

Connecting the RS-232 Interface

The RS-232 data communication interface supports the querying of status information and temperature data from the oven by entering basic commands in a standard terminal window provided by your computer's operating system. The interconnection requires a standard RS-232 cable with 9-pin connectors and a straight "1:1" pinout without any crossed wires, which is not supplied with the oven.

Users may employ the RS-232 command inventory listed in [Table 5-1](#) below for automating process data logging - for example, by embedding these commands in scripts that run on a remote computer.

Interconnecting the Oven with a Computer

1. Turn the computer off.
2. Route the serial interface cable along a path that does not cross hot exhaust air piping, tables, aisles or passageways.

With stacked devices, keep the serial interface cable away from hot spots on the other oven in the stack.

3. Connect one connector of the serial interface cable (cable length, 5 to max. 10 m, not supplied as a standard item) to the socket labeled **RS 232** in the electrical interfaces section at the rear of the oven (see “Signal Interfaces and Power Socket” on page 4-7).
4. Connect the second connector to an unused COM 1 /COM 2 or other serial port on the computer.
5. Boot the computer.
6. Launch your standard terminal program and set up the connection with the following parameters:
 - 57600 bits per second
 - 8 data bits
 - 1 stop bit
 - No Parity
7. Once your terminal indicates that serial communication has been established successfully, enter any of the commands listed in Table 5-1 below, depending on what type of information you want to query.
8. Use the following generic command syntax:

?:aaaa:00:Cn , where:

- **?:** identifies the command line as a query;
- **aaaa:** is the parameter address;
- **:Cn** specifies the type of data to be queried (see the examples in Table 5-1 for reference)
- **:00** is a response field (retained in the query for technical reasons) that must be left at “00”;
- **<CR>** is for carriage return.

You will receive a response of the following general format:

!:aaaa:bb:XXXXX:cc<CR> , where:

- **!:** identifies the line as a response to a query;
- **aaaa:** is the parameter address entered with the query;
- **bb:** is the number of payload bytes in hexadecimal code - for example, **1F** for the decimal value **31**;
- **XXXXXX:** is the significant status information queried;
- **cc:** is a check sum (technically an inverted XOR of all bytes returned, excluding the check sum bytes and the <CR> character);

— <CR> is for carriage return.

Table 5-1 Terminal Commands for Querying Data

Command Syntax	Response Example
Combined Date and Time	
?:0010:00::c1	!:0010:11: 31.07.10 ; 01:02:23 :e2 Date Time
Date only	
?:0011:00::c0	!:0011:08: 31.07.10 :d2 Date
Time only	
?:0012:00::c3	!:0012:08: 01:02:23 :dc Time
Temperature Set Value (T1); Current Work Space Temperature (T2); Reference Temperature (T3); Sample Sensor Temperature (T4)	
?:3010:00::c2	!:3010:1f:+125.00;+124.96;+000.000;+000.00:b0 T1 T2 T3 T4

DOMINIQUE DUTSCHER SAS

DOMINIQUE DUTSCHER SAS



Operation

Preparing the Oven

The oven must not be released for operation before all major start-up activities have been completed (see “Start-up” on page 5-1).

Device Check

Prior to starting operation, the following oven components must be checked for their correct function:

- The door seal in the front frame must not be damaged.
- The shelving components must be installed safely.

Disinfecting the Oven’s Work Space



Disinfect the work space according to the operator-specified hygiene guidelines.

Starting Operation

1. Turn the oven on using the control panel.
2. Adjust the temperature set value on the control panel.
3. The temperature controller starts adjusting the work space to the user-specified temperature set value now.



NOTE

Upon initial installation and subsequent heat-up, this appliance may produce an odor and trace evolution of non-toxic vapor that results from brake-out of the insulation binder. This condition is normal for factory-new products and will diminish with continued operation.

		To avoid any risk of explosion or fire
<ul style="list-style-type: none">• refrain from loading the oven with any of the substances listed in the section “Incorrect Use” on page 1-6• make sure that the ambient air is free of any solvents• do not operate the oven in areas with an explosion hazard		

4. Load the work space with samples.

	Risk of overloading
<p>Overloading may damage the shelves or cause the shelves and/or the oven to tilt when the shelves are being drawn out, ultimately destroying the samples. To avoid overloading the oven or its shelving be sure to observe the sample weight limits specified in see “Technical Data” on page 13-1</p>	

		Hot surfaces
<p>The interior panel of the outer door as well as the surfaces of the outer housing, the shelving and the work space become extremely hot while the oven runs through its heating cycles.</p>		
<p>When removing samples from a running or recently completed heating cycle, always wear safety gloves and other appropriate personal protection equipment to avoid burns on hot surfaces!</p>		

	Proper loading
<p>To ensure sufficient air circulation and uniform heating of the samples, do not use more than 70% of the maximum surface area of the work space. Bulky objects in the work space that dissipate heat may impair heat distribution.</p>	

Handling and Control

Heratherm OGS Series and OMS Series ovens come with a front panel mounted control unit consisting of a multifunctional display, four control buttons, and an on/off button. The four control buttons interact with the display window to let users access all of the user control functions and adjustments of the oven, including - for example, the temperature set value, timer, as well as a variety of other functions.





Under normal operating conditions the display presents user with the work space temperature. The display returns to its default mode upon completion of the adjustments or whenever no entries have been made for a period of 30 seconds.

Figure 7-1 Control Panel for Heratherm OGS Series and OMS Series Ovens







The table below contains brief descriptions of the buttons on the control panel (items K1 through K5 in [Figure 7-1](#)).

Table 7-1 Control Buttons

Icon	Item	Function
	K1	<p>Menu/Enter button</p> <p>First key press: Activates the menu, highlighting the first menu item with a red border.</p> <p>Second key press: Selects the currently activated menu item (as highlighted by the red border). At the same time pressing this button enables entries with item D1.</p> <p>Third key press (once a setting has been changed): Confirms a previous entry or selection.</p>
	K2	<p>Left button</p> <p>After the first press of the Menu/Enter button:</p> <ul style="list-style-type: none"> - Moves the selection in the menu (see item D2) to the next icon on the left. <p>Once a menu item has been selected:</p> <ul style="list-style-type: none"> - Decreases an adjustable parameter value - for example, the temperature set value in D1. Holding this button depressed for a few seconds changes the selected value in quick run mode.
	K3	<p>On/Off button</p> <p>Holding this button depressed for 2 seconds switches the oven off. The display window goes out, except for the readiness indicator icon in the status display area at item D3. The temperature display pane D1 provides as dimmed readout of the work space temperature, provided that the temperature exceeds 50 °C (122 °F).</p>
	K4	<p>Right button</p> <p>After the first press of Menu/Enter button:</p> <ul style="list-style-type: none"> - Moves the selection in the menu (see item D2) to the next icon on the right. <p>Once a menu item has been selected:</p> <ul style="list-style-type: none"> - Increases an adjustable parameter value - for example, the temperature set value in D1. Holding this button depressed for a few seconds changes the selected value in quick run mode.
	K5	<p>Escape button</p> <p>Returns to the previous level of the menu or standard display. Upon exiting from the current menu item the user may be prompted to save any previously made settings.</p>

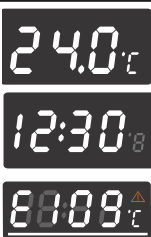
The table below contains brief descriptions of the display features of the control panel (items D1 through D3 in [Figure 7-1](#); the identifiers K1 through K4 refer to the buttons shown in that figure).

Table 7-2 Display Features

Feature	Item	Function
	D1	<p>Display pane showing a permanent readout of the actual temperature in the work space either in °C or °F (depending on the user's preferences, see “Toggling the Temperature Display Unit” on page 7-11).</p> <p>A flashing time entry prompt of the general format hh:mm (hours:minutes, both with two digits) appears in this place while the user is setting up a timer.</p> <p>Upon occurrence of an error condition, the current error code flashes in this area. Additionally, the red alarm icon at D3 flashes.</p>
	D2	<p>Menu bar with iconized representations of adjustable parameters. A red border is used to highlight the current menu item, as selected using the Menu (K1) and arrow buttons Left (K2) and Right (K4). Brief descriptions of the individual menu items are given in Table 7-3 below.</p> <p>Note If a menu item cannot be selected, then the function it represents is not part of the equipment configuration of your unit.</p>
	D3	<p>Alarm icon: Upon occurrence of an error condition, the red alarm icon will be illuminated. At the same time the current error code will flash in the display pane D1. The alarm may be acknowledged by pressing the  button.</p>

The table below contains brief descriptions of the menu bar icons (item D2 in [Figure 7-1](#)).

Table 7-3 Menu Bar Icons





Icon	Function
	<p>Temperature Set Value</p> <p>Allows for changing the temperature set value (factory-preset to 50 °C/122 °F) within the permissible temperature range. The set value can be changed by pressing the Left and Right (item K2 or K4) and you can, after confirming your changes with the Menu/Enter button (item K1), track the impact on the actual temperature in the display pane at D1.</p> <p>Instructions: “Temperature Set Value” on page 7-6.</p>
	<p>Timer</p> <p>Allows for having the oven turn on and/or off upon expiry of a user-specified countdown period. When the user enables an “on timer” the oven goes out. A rotating in the Timer icon and the illuminated readiness indicator icon in the status display area indicates that the timer is running.</p> <p>Instructions: “Timer” on page 7-7.</p>
	<p>Settings</p> <p>Invokes a submenu with the following functions:</p> <ul style="list-style-type: none"> - Read access to error log - Calibrating the oven - Toggling the temperature display unit between °C and °F - Entering a configuration control code <p>(Instructions: “Settings” on page 7-9)</p>

Table 7-3 Menu Bar Icons

Icon	Function
	<p>Readiness Indicator: Illuminated when the oven has been switched off using the On/Off button (item K3 in Figure 7-1). Unlike other menu items, this icon cannot be selected. (Instructions: “Switching the Oven Off / Powering Down” on page 7-5)</p>
	<div style="border: 1px solid black; padding: 5px;"> <p style="text-align: center;">NOTE</p> <p>Button Inactivity Monitoring</p> <p>When no button is pressed for more than 30 seconds in any selected menu item, the display exits from the selected screen and returns to default display mode.</p> </div>

Powering Up

1. Plug the power plug of the oven into a suitable protection-earthed AC power outlet.



In the display window on the front panel the readiness indicator icon (top right item at D3 in [Figure 7-1](#) on [page 7-1](#)) is illuminated.



2. Keep the **On/Off** button depressed for two seconds.

An initialization routine will be run after the oven has been powered up. Once initialization has been completed, the display will light up and the current work space temperature will appear in the temperature display pane (item D1 in [Figure 7-1](#) on [page 7-1](#)). The oven is ready for use now.

Switching the Oven Off / Powering Down



1. Keep the **On/Off** button depressed for two seconds.

The display window goes out, except for the readiness indicator icon (rightmost icon in the top right item at D3 in [Figure 7-1](#) on [page 7-1](#)) and a residual heat temperature readout in case the work space temperature is still higher than 50 °C/122 °F. The oven is switched off now.



2. If required, unplug the AC power plug to power down the oven completely.



Temperature Set Value

Heratherm ovens allow for setting the desired work space temperature directly using only a few button presses. After confirming the new temperature set value, you may trace the resulting temperature change in the temperature display pane (item D1 in [Figure 7-1](#) on [page 7-1](#)).

You can also use the temperature set value to speed up cool-down subsequent to a drying or heating process. The usable set temperature range of Heratherm ovens has a factory-preset lower limit of 50° C. You can set the oven to a set temperature of 0 °C, though, to speed up cool-down. This is achieved in one single step, as described further below.

Table 7-4 Adjusting the Temperature Set Value

	<p>Press to activate the menu bar, then use to select the Temperature icon and press to confirm.</p>
	<p>In the temperature display pane, press or to adjust a new temperature set value, then press to confirm your settings.</p>
	<p>The display returns to its default mode. The actual temperature measured in the work space and shown in the temperature display area starts to change until it reaches the newly adjusted set value.</p>

Table 7-5 Using the Temperature Set Value to Speed Up Cool-Down

	<p>At the end of the drying or heating process, press to activate the menu bar, then use to select the Temperature icon and press to confirm.</p>
	<p>In the temperature display pane, press to lower the temperature set value to 50 °C, then on to 0 °C in one additional step. When the display reads 0 °C, press to confirm your settings.</p>
	<p>The display returns to its default mode. The actual temperature measured in the work space and shown in the temperature display area starts to drop, showing the progress of the cool-down process.</p>



Timer

The **Timer** feature from the menu bar enables the user to set a “countdown-type” on or off timer that switches the oven on or off after a preset period of time. Instructions for setting an off timer are given in [Table 7-6](#) (see below), while its use as an on timer is described in [Table 7-7](#) on [page 7-7](#).

Programming a turn-on time causes the oven to shut down until it is scheduled to restart, while a turn-off time keeps it running before it shuts down at the user-specified time. The timer starts running immediately as soon as the user confirms his or her entries.

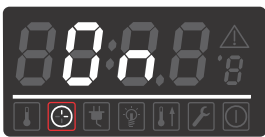

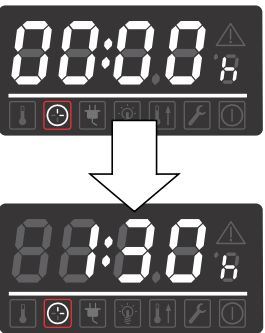



Table 7-6 Setting a Countdown-type Off Timer

	<p>Press to activate the menu bar, then use to select the Timer icon and press to confirm.</p>
	<p>The word OFF appears in the multifunctional display pane. Choose the off timer with .</p>
	<p>Set the hours and minutes until the oven is supposed to shut down by pressing or , then press to confirm.</p>
	<p>The display returns to its default mode. In the menu bar, the Timer icon is illuminated and a is rotating on the icon's face.</p>

Table 7-7 Setting a Countdown-type On Timer

	<p>Press to activate the menu bar, then use to select the Timer icon and press to confirm.</p>
	<p>The word Off appears in the multifunctional display pane.</p>

Table 7-7 Setting a Countdown-type On Timer

	<p>Press  to select the On timer option and confirm the selection with .</p>
	<p>Set the hours and minutes until the oven is supposed to turn on by pressing  or , then press  to confirm.</p>
	<p>The oven switches off. The display goes out, the Timer icon is illuminated in the menu bar with a hand rotating on its face. Additionally, the readiness indicator icon is illuminated.</p>

Stopping a Timer

Table 7-8 Stopping an Off Timer Before It Expires













	<p>Press  to activate the menu bar, then use  to select the Timer icon and press  to confirm.</p>
	<p>Confirm the OFF by pressing , then press  to return to the main menu.</p>
	<p>In the menu bar, the Timer icon  will go out. The display returns to its default mode.</p>

Table 7-9 Stopping an On Timer Before It Expires

	<p>To cancel a pre-programmed on timer while the oven is switched off, hold the On/Off button depressed for a few seconds.</p>
	<p>In the menu bar, the Timer icon  will go out. The display returns to its default mode.</p>



Settings

The **Settings** menu item opens a submenu populated with various commands for viewing general status information on the unit and setting preferences for the operation of the oven or its display window:

- Read access to error log
- Calibrating the oven
- Toggling the temperature display unit between °C and °F
- Toggling process protection on and off
- Entering a configuration control code

Instructions for using these features are given in the following.

Error Log

Users calling customer service for support may be asked by the agent to supply information from the error log of the oven. It enables the user to browse through the most recent 22 alarm messages that were caused by hardware or control loop errors. Each error is displayed with an internal error code.

Error codes and instructions for clearing alarm conditions appear in the section “[Error Codes](#)” on [page 12-1](#).

Table 7-10 Reading the Error Log

	<p>Press to activate the menu bar, then use or to select the Settings icon and press to confirm.</p>
	<p>The word Err appears in the display pane to indicate that the error log has been selected.</p>
	<p>Use the button to select the first entry in the error log, numbered E01 (Error 01). This entry represents the most recently registered error.</p> <p>After a few seconds, the display pane automatically switches to the internal error code - for example, 109. E01 shows the latest fault, E22 shows the oldest fault.</p>

Table 7-10 Reading the Error Log

	<p>Press to go to the next entry (or to go back to the previous one).</p> <p>After reaching the entry numbered 22 the display wraps and returns to the beginning of the error log, that is, to entry “number E01.”</p>
	<p>To exit from the error log and return to normal display mode press twice.</p> <p>The Settings icon in the menu bar will go out.</p>

Calibration

The **Settings -> Calibration** menu item enables the user to initiate a temperature calibration routine for the built-in temperature sensors and choose whether calibration should be accomplished manually or automatically:







- The **Manual** option allows for entering an absolute temperature directly, as measured - for example, using an external reference sensor.

<h3 style="margin: 0;">NOTE</h3>	<h4 style="margin: 0;">Calibration Prerequisites</h4>
<p>Maintain the ambient conditions within the specified limits of the oven and make sure that the damper is fully closed before launching calibration.</p> <p>Varying ambient conditions and/or an open damper may impact the result of the calibration routine, which may lead to misadjustment of the controller and unreliable temperature control operation.</p>	

Table 7-11 Entering the Calibration Reference Temperature Manually

	<p>Press to activate the menu bar, then use or to select the Settings icon and press to confirm.</p>
	<p>Press to switch to the CAL(ibration) menu item.</p>

Table 7-11 Entering the Calibration Reference Temperature Manually

	<p>The word USER appears in the display pane. Press  to confirm the selection.</p>
	<p>In the settings dialog that appears, set the temperature measured with the external reference sensor by using  or  and confirm your settings with .</p>
	<p>The newly entered value will be stored and used to calibrate the internal temperature sensors with the value measured by the reference sensor. The display returns to its default mode. The Settings icon in the menu bar will go out.</p>

Temperature Display Unit

The **Settings -> °C / °F** menu item allows for toggling the unit used for displaying temperatures between degrees Centigrade and Fahrenheit.

Note This setting does not have any impact on data logging via the RS-232 interface. Any temperature data that is logged to a computer for operational parameter documentation purposes is handed over in °C.

Table 7-12 Toggling the Temperature Display Unit







	<p>Press  to activate the menu bar, then use  or  to select the Settings icon and press  to confirm.</p>
	<p>Press  to switch to the C - F menu item. The text C - F is flashing in the display pane.</p>

Table 7-12 Toggling the Temperature Display Unit

	<p>Press the button.</p> <p>The currently unused temperature unit °C or °F is flashing in the display pane. (The factory default setting is °F.)</p> <p>Press or to switch to the desired temperature unit and confirm the selection with .</p>
	<p>The temperature unit to the right of the temperature display field (item D1 in Figure 7-1 on page 7-1) has changed according to your selection.</p> <p>The display returns to its default mode.</p> <p>The Settings icon in the menu bar will go out.</p>







Configuration

The **Settings -> Configuration** menu item enables the user to enter a four-digit code that loads a specific set of operating parameters for the oven - for example, in order to make the voltage selection described in the section “[Connecting the RS-232 Interface](#)” on [page 5-9](#) (only for 100 and 180 liter units).

Table 7-13 Entering the Four-digit Code

	<p>Press to activate the menu bar, then use or to select the Settings icon and press to confirm.</p>
	<p>Press to switch to the ConF(iguration) menu item. The word ConF will be flashing in the multifunctional display pane.</p> <p>Press the button.</p>

Table 7-13 Entering the Four-digit Code

	<p>The multifunctional display pane will present a prompt similar to the example shown at left, with the first digit of the four-digit configuration code flashing.</p> <p>Set the first digit of the configuration code using  (or ) and confirm your setting with .</p> <p>Set the remaining three digits exactly as described above.</p> <p>Enter code "1234" to reset the user calibration.</p> <p>By confirming your entry for the last digit with , the new configuration is activated immediately.</p>
	<p>The display returns to its default mode.</p> <p>The Settings icon in the menu bar will go out.</p>

DOMINIQUE DUTSCHER SAS

Shut-down

This chapter provides instructions for shutting the oven down for prolonged periods of time, that is, at least for several days in a row.



Shutting the Oven Down

1. Remove the containers with the samples and all accessories from the work space.
2. Turn the oven off using the control panel.
3. Unplug the power cord and secure it against accidental reconnection.
4. Until the oven is shut down, the work space must be continuously ventilated. Leave the door open and secure it against accidental closure.

DOMINIQUE DUTSCHER SAS

Cleaning and Disinfection

Cleaning

		Incompatible cleaners
		<p>Some oven components are made of plastics. Solvents may attack plastics. Strong acids or alkaline solutions may cause embrittlement of plastics.</p>
		Moisture-sensitive components
		<p>Do not spray cleaning agent onto the control panel and the control box at the rear of the oven. When wiping the oven clean, always make sure that no moisture enters into these components. Wipe the display window down with a slightly dampened cloth, then wipe dry with a rag made of 100% microfiber.</p>

Cleaning exterior surfaces

Remove dirt residues and depositions thoroughly using a solution of lukewarm water and commercial detergent.



Wipe the surfaces clean using a clean cloth and clear water.

Then, wipe the surfaces dry using a clean cloth.



Wipe / Spray Disinfection



The manual wipe and spray disinfection is the following process:

- predisinfection,
- Cleaning as appropriate for the current application.

		Alcoholic disinfectants!
		<p>Disinfectants having an alcohol content of more than 10% may form, in combination with air, easily combustible and explosive gas mixtures.</p>
		<p>When using such disinfectants, avoid open flames or exposure to excessive heat during the entire disinfection process!</p>
		<p>Use such disinfectants only in adequately ventilated rooms.</p>
		<p>After the disinfectant has been allowed to react, wipe the cleaned oven components thoroughly dry.</p>
		<p>Observe safety regulations to avoid fire and/or explosion hazard caused by alcohol-containing disinfectants.</p>
		<p>Chloride-containing disinfectants!</p>
		<p>Chloride-containing disinfectants can corrode stainless steel and galvanized metal surfaces.</p>
		<p>Use only disinfectants that do not affect stainless steel and galvanized metal surfaces!</p>
		

Preparing the manual wipe/spray disinfection

		Electric shock
		<p>Touching live electrical components may cause a lethal electric shock.</p>
		<p>Before connecting the oven to the power supply, check the plug and power cord for damage. Do not use damaged cables for connecting the oven to the power source!</p>

	 WARNING	Health hazard
	The surfaces of the work space may be contaminated. Contact with contaminated cleaning liquids may cause infections. Disinfectants may contain harmful substances.	
	When cleaning and disinfecting, always observe the safety instructions and hygiene guidelines!	
	<ul style="list-style-type: none">• Wear safety gloves.• Wear safety goggles.• Wear mouth and respiratory system protection gear to protect your mucous membranes.• Observe the safety instructions of the disinfectant's manufacturer and the hygiene supervisor.	

Predisinfection

1. Remove all samples from the work space and store them in a safe place.
2. Spray disinfectant onto the surfaces of the work space and of the accessories or wipe the surfaces clean using disinfectant.
3. Allow time for the disinfectant to act as specified by the manufacturer.

 NOTE	Disinfecting hard-to-reach components
Spray the sensor and other hard-to-reach components with disinfectant!	

DOMINIQUE DUTSCHER SAS

Maintenance

Regular maintenance is mission-critical to avoid malfunctions due to ageing and wear. Failure to perform maintenance on a regular basis may result in:

- deviations in heating performance
- damage to samples
- loss of control over temperature distribution throughout the work space

Inspections and checks

To ensure the operational performance and safety of the oven, their functions and the components listed below must be checked at regular intervals.

Regular Checks

- Check the oven for overall cleanliness and remove any debris from previous processes.
- To avoid operation without an appropriate fresh air supply, check the air filter (optional) in the air inlet for contamination.

Monthly Inspection

- Check integrity and proper seating of the door seal.
- Swap air filter cartridge (optional) in air inlet.
- Perform functional check of the control panel and of the oven's built-in controller.
- Perform electrical safety check in accordance with the relevant national regulations.

NOTE

Functional check

If safety devices were removed or disabled for inspections, the oven must not be operated before the safety devices have been reinstalled and checked for their correct function.

	<div style="border: 1px solid black; padding: 5px;"><div style="display: flex; align-items: center;"><div style="margin-left: 5px;">WARNING</div></div><p style="margin-top: 5px;">Spare Parts and User Modifications</p><p>To avoid major malfunctions of the oven and associated safety hazards that may result in death, serious injuries, or damage to the oven and other equipment, use spare parts approved by Thermo Electron LED GmbH only. Third-party spares without approval void the limited warranty.</p><p>Do not modify the oven in any way without obtaining the prior written authorization from Thermo Electron LED GmbH. Unauthorized modifications may compromise operational safety and give rise to hazards that may result in death, serious injuries, or damage to the oven and other equipment.</p></div>
--	---

Service Intervals

During ongoing operation, the following service work must be performed:

Annual service

Have the oven inspected and serviced by an authorized Technical Service agent.

	<div style="border: 1px solid black; padding: 5px;"><div style="display: flex; align-items: center;"><div style="background-color: #0056b3; color: white; padding: 5px 10px; font-weight: bold; font-size: 1.2em;">NOTE</div><div style="margin-left: 10px;">Service contract</div></div><p style="margin-top: 5px;">Thermo Electron LED GmbH offer a product-specific service contract comprising all necessary tests and service work.</p></div>
--	---

Replacing the Door Seal

The door seal of the outer door is located in the retaining slot.

The door seal should be inspected for any signs embrittlement every six months when the oven has been used at maximum temperatures of up to 250 °C / 482 °F.

No tools are required to replace the seal.

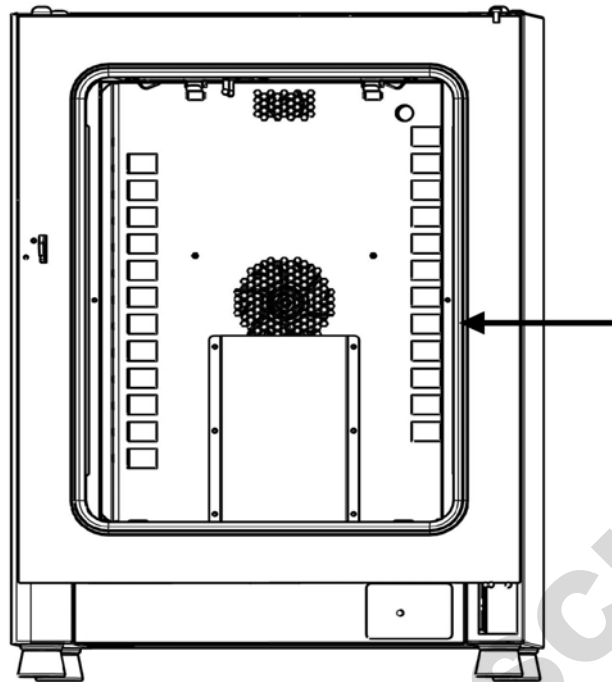

Figure 10-1 Door seal replacement (example showing OMH Series oven)

1. Pull the seal out of the guide slot.
2. Starting on the hinge side of the door, position the seam of the new seal at the location indicated by the arrow in [Figure 10-1](#) above.
3. Gently press the seal into the slot, working around the circumference of the door. In doing so, be careful not to stretch the seal.
4. Make sure that the retaining rail taper is positioned correctly in the slot and that the seal is flush with the door frame.





Replacing the Power Cord

When the device's power cord is damaged, it must be replaced with an original spare part. Using a standard power cord with a lower temperature withstand class is prohibited.

Returns for Repair



Prior to returning any materials, please contact our Customer Service Department for a "Return Materials Authorization" number (RMA).

Material returned without an RMA number will be refused.

	<table border="1"><tr><td data-bbox="539 264 898 353"> WARNING</td><td data-bbox="930 280 1244 313">Contamination hazard</td></tr></table> <p>The oven may have been used for treating and processing infectious substances, which may have caused contamination of the oven and its components. Prior to return shipment, it is therefore mandatory that all oven components be properly decontaminated..</p> <ul style="list-style-type: none">• Clean the oven components thoroughly, then disinfect or decontaminate them (depending on application).• Fill in and attach a safety declaration with details on decontamination activities performed to the items that are to be repaired.	 WARNING	Contamination hazard
 WARNING	Contamination hazard		

DOMINIQUE DUTSCHER SAS

Disposal

	<div style="border: 1px solid black; padding: 5px; margin-bottom: 10px;">  WARNING </div> <p>Contamination hazard</p> <p>The oven may have been used for treating and processing infectious substances, which may have caused contamination of the oven and its components. Prior to disposal, it is therefore mandatory that all oven components be properly decontaminated.</p> <p>Clean the oven components thoroughly, then disinfect or decontaminate them (depending on application).</p> <p>Attach a declaration of decontamination with details on decontamination activities performed to the items that are to be disposed of.</p>
---	---

Overview of Materials Used

Component	Material
Thermal insulation components	Glass wool
Printed circuit boards	Coated electrical components contain various plastics materials. Components mounted on circuit boards containing epoxy resin bonder.
Plastic components, general	see material labelling
Exterior housing	Galvanized steel sheet, painted
Oven rear panel	Galvanized steel sheet
Outer door	Galvanized steel sheet, painted
Door inner panel	OMS and OGS: stainless steel 1.4016
Control panel and display window protective foil	Polyethylene
Heater	Stainless steel-sheathed resistance heater wires

Component	Material
Interior containers, installed components and shelves	Stainless steel 1.4016 and galvanized steel; shelves are chrome-plated
Door frame seal	Silicone
Fan wheel	Stainless steel 1.4016 (OMS Series only)
Cables	Plastic-sheathed stranded copper wire
Packaging	Corrugated board, polyethylene film, and styrofoam, chemically untreated wood

WEEE Conformity

This product is subject to the regulations of the EU Waste Electrical & Electronic Equipment (WEEE) Directive 2002/96. It is marked by the symbol shown below.



Thermo Electron has entered into agreements with recycling and disposal companies in all EU Member States for the recycling and disposal of this oven. For information on how Thermo Electron secures conformity with this directive, on recycling and disposal companies in your country and on the products of Thermo Electron, which fall under the RoHS Directive (Restriction of the use of certain hazardous substances in electrical and electronic equipment), please visit the website www.thermo.com/WEEERoHS.

Error Codes

Table 12-1 below lists the error messages that may appear in the control panel display window (see “Error Log” on page 7-9) and provides instructions for clearing such alarms.

Table 12-1 Heratherm Oven Error Codes



Error Message & Code	Root Cause	Alarm Response	Alarm Clearing Instructions*
Display Error (E002)	Display communication error. The built-in controller was unable to restore communication with the control panel.	Audible alarm activated, message shown on display.	Power cycle the device by unplugging, then reconnecting the power cord. If this doesn't solve the problem, call service.
Mirrored Parameter Loaded (E003)	The controller was unable to read the user-specific settings and had to resort to an emergency parameter set held in mirrored storage.	. Fallback to mirrored parameter storage. Device continues to run without loss of functionality, including user-specific settings.	Check the latest settings, for example the set value.
Factory Parameter Loaded (E004)	The controller was unable to read the mirrored parameter set and had to resort to factory-preset parameters.	Fallback to factory-preset parameters. Audible alarm activated, message shown on display. User-specific settings may be lost - for example, the temperature display unit preference, or user programs.	Acknowledge by pressing  .
Default Parameter Loaded (E005)	The controller was unable to read the factory-preset parameters and had to resort to default settings	Fallback to default parameters. User-specific settings will be unavailable. Audible alarm activated, message shown on display. The device is completely inoperative.	Call service.
Power Down Error (E007)	Power has been cut off (power outage) while the device was running.	Audible alarm activated, message shown on display.	Check the power supply. Power up then device, then acknowledge the alarm by pressing  .
Fan Error (E009)	Fan speed out of range. (OMS Series only)	Audible alarm activated, message shown on display. Heater disabled by controller.	Acknowledge by pressing  . If this doesn't solve the problem, call service.
Config Error (E012)	General device configuration error.	Audible alarm activated, message shown on display. No user entries accepted by control panel.	Call service.

Table 12-1 Heratherm Oven Error Codes

Error Message & Code	Root Cause	Alarm Response	Alarm Clearing Instructions*
OTP error (E013)	Klixon contact not closed.	Overtemperature Protection fault. Audible alarm activated, message shown on display. Bridging across Klixon contact has failed (Klixon has tripped or is not installed.)	Power cycle the device by unplugging, then reconnecting the power cord. If this doesn't solve the problem, call service.
Sensor Error (E100)	Process sensor damaged. The actual measured value is out of range.	Audible alarm activated, message shown on display. Control transferred to reference sensor. If both sensors are defective, disable all control circuits.	Call service.
Temperature Too High (E101)	Actual measured value exceeds permissible range. May occur when the user lowers the set point temperature on a hot device whose door is closed. If not solved by opening the door. The triac in the heater circuit may be defective.	Process protection activated, control continues on set value. Audible alarm activated, E101 message shown on display.	Open the door and allow the device to cool down. If this does not solve the problem, call service.
Temperature Not Plausible (E103)	The difference between the control and reference sensors exceeds the maximum permissible deviation, rendering the measurement implausible.	Device uses the sensor that indicates the higher temperature for servo control. Audible alarm activated, message shown on display. Error can be acknowledged and resets when difference between actual and set value goes away.	If the problem does not go away, call service.
Calibration Value Too High (E104)	The calibration reference value calculated on the basis of the user input falls short of the upper limit for calibration references.	Fallback to previous calibration reference. Audible alarm activated, message shown on display.	Check the external reference sensor for proper function and replace, if necessary. If this does not solve the problem, call service.
Calibration Value Too low (E105)	The calibration reference value calculated on the basis of the user input exceeds the lower limit for calibration references.	Fall back to previous calibration reference. Audible alarm activated, message shown on display.	Check the external reference sensor for proper function and replace, if necessary. If this does not solve the problem, call service.
Constant Sensor Signal (E106)	None of the decimal places of the A/D-converter output for the process sensor has changed over a specific time period.	Control transferred to reference sensor, audible alarm activated, message shown on display. If both sensors are defective, all control circuits will be disabled.	Call service.

Table 12-1 Heratherm Oven Error Codes

Error Message & Code	Root Cause	Alarm Response	Alarm Clearing Instructions*
Constant Reference Sensor Signal (E107)	None of the decimal places of the A/D-converter output for the reference sensor has changed over a specific time period.	Control continues on process sensor, audible alarm activated, message shown on display. If both sensors are defective, all control circuits will be disabled.	Call service.
Constant Sample Sensor Signal (E108)	None of the decimal places of the A/D-converter output for the sample sensor has changed over a specific time period.	Audible alarm activated, message shown on display.	Call service.
Heating Relay Error (E109)	The voltage measurement has indicated a defect in the heater circuit relay.	Device completely inoperative, audible alarm activated, message shown on display.	Be sure to pull the power plug and disconnect the device from the AC mains. Call service.
Heating Triac Error (E110)	The voltage measurement has indicated a defect in the triac	Audible alarm activated, message shown on display. Overheat protection activated to prevent destruction of the samples. Audible alarm returns upon acknowledgement.	Call service.
Temperature Too High (E111)	The actual measured value exceeds the upper limit of the permissible error range. May occur when the user lowers the set point temperature on a hot oven but leaves the door closed.	Audible alarm activated, message shown on display. Heater turned off until upper limit of hysteresis is recovered. Servo control operations continue. Alarm can be acknowledged, and goes away when the difference between the actual and set values ceases to exist. Note: This error does not indicate a defective triac.	Open the door to speed up cool-down. Check whether the device was loaded with a hot object, If so, remove. If this doesn't solve the problem, call service.
Sensor Error (E112)	Unsuitable sample load or possible damage to reference sensor. The measured actual value is out of range.	Audible alarm activated, message shown on display. Control continues on process sensor. If both sensors are defective, all control circuits will be disabled.	Check whether device was loaded with an unsuitable object. If error does not go away, call service.
Sensor Error (E113)	Sample sensor damaged. The actual measured value is out of range.	Audible alarm activated, message shown on display.	Call service.

Table 12-1 Heratherm Oven Error Codes

Error Message & Code	Root Cause	Alarm Response	Alarm Clearing Instructions*
ADC Error (E114)	A/D converter does not supply a plausible output. Measurement across reference resistor R403 has failed. ADC converter may be defective.	Audible alarm activated, message shown on display. All control circuits disabled.	Call Service.
Watchdog error (E115)	Watchdog test failed on power-up.	Audible alarm activated, message shown on display.	Call service.

* Clearing should mute the audible alarm, de-energize the alarm relay, and clear the message from the control panel display.

DOMINIQUE DUTSCHER SAS

Technical Data

The technical data are valid only for an empty device equipped with three shelves and a spray-painted outer enclosure. Options may have an impact on the specified performance.

Table 13-1 Technical Data - OGS and OMS Series

Parameter	Unit	OGS 60	OGS 100	OGS 180	OMS 60	OMS 100	OMS 180
Process							
Temperature deviation from set value at 150° C, spatial. Max. value/Typical. value	K	±4.5 / ±4.4	±4.5 / ±4.0	±4.5 / ±4.0	±3.5 / ±2.8	±3 / ±2.5	±3.5 / ±2.8
Temperature deviation from set value at 150° C, over time.	K	±0.4	±0.4	±0.5	±0.3	±0.3	±0.3
Heat-up time (work space unoccupied, from 25°C to 98% of set temperature of 150° C) Max. value/Typical. value	min	25	25	25	18	16/14	18
Recovery time (work space unoccupied, door open for 30 s, to set temperature) Max. value/Typical. value	min	8/9	8/9	8/9	5	5	5
Heat dissipation to environment (at set temperature of 150° C and room temperature of 25° C)	W	291±10%	426±10%	473±10%	291±10%	426±10%	473±10%
Overall dimensions							
Height	mm/in	720/ 28.3	820/ 32.3	920/ 36.2	720/ 28.3	820/ 32.3	920/ 36.2
Width	mm/in	530/ 20.8	640/ 25.2	640/ 25.2	530/ 20.8	640/ 25.2	640/ 25.2
Depth	mm/in	565/ 25.2	565/ 25.2	738/ 29.1	565/ 25.2	565/ 25.2	738/ 29.1
Overall weight	kg/lbs	42/93	53/117	66/146	42/93	53/117	66/146
Loading capacity							
Loading capacity per shelf	kg/lbs	25/55			25/55		
Max. overall loading capacity per device	kg/lbs	50/110	50/110	75/165	50/110	50/110	75/165

Table 13-1 Technical Data - OGS and OMS Series

Parameter	Unit	OGS 60	OGS 100	OGS 180	OMS 60	OMS 100	OMS 180
Electrical data							
Power rating	W	1800	3100	3100	1400	3360	3360
Maximum current	A	7.9	13.5	13.5	6.1	14.0	14.0
Earthing system (e.g. 1/N/PE)		1/N/PE	1/N/PE	1/N/PE	1/N/PE	1/N/PE	1/N/PE
Power line frequency	Hz	50			50		
Power line voltage +/- 10 %	V	230	230		230	230	
IP protection system		IP 20			IP 20		
Protection class		I			I		
Overvoltage category		II			II		
Device fusing, building side	A	16			16		
Device fusing, on PCB	A	2 x 16			2 x 16		
Environmental conditions							
Min. ambient temperature	°C/°F	18/65			18/65		
Max. ambient temperature	°C/°F	32/90			32/90		
Max. humidity in service, non condensing	% r.F./% r.H.	80, non condensing			80, non condensing		
Min. storage temperature	°C/°F	20/68			20/68		
Max. storage temperature	°C/°F	60/140			60/140		
Max. humidity in storage, non condensing	% r.F./% r.H.	90, non condensing			90, non condensing		
Post-transport acclimation time	h	2			2		
Noise level	dB(A)	no inherent noise			45	52	52
Pollution degree		2			2		
Site conditions							
Maximum altitude above sea level	m/y ASL	2000/2187			2000/2187		
Minimum side clearance	mm/in	50/2			50/2		
Minimum front clearance	mm/in	590 / 23.2	690 / 27.2	814 / 32	590 / 23.2	690 / 27.2	814 / 32
Minimum back wall clearance	mm/in	80/3.2			80/3.2		
Minimum bottom clearance	mm/in	200/8			200/8		
Minimum top clearance	mm/in	300/12			300/12		

Spare Parts and Accessories

Material No.	Description
50127436	Door seal kit for Heratherm 60L
50127437	Door seal for Heratherm 100L
50127438	Door seal for Heratherm 180L
50127761	Wire mesh shelf OGS 60 / OGH 60 / OGH-S 60, including 2 shelf support brackets
50127762	Wire mesh shelf OGS 100 / OGH 100 / OGH-S 100, including 2 shelf support brackets
50127763	Wire mesh shelf OGS 180 / OGH 180 / OGH-S 180, including 2 shelf support brackets
50127764	Wire mesh shelf OMS 60 / OMH 60 / OMH-S 60, including 2 shelf support brackets
50127765	Wire mesh shelf OMS 100 / OMH 100 / OMH-S 100, including 2 shelf support brackets
50127766	Wire mesh shelf OMS 180 / OMH 180 / OMH-S 180, including 2 shelf support brackets
50127773	Stainless steel perforated shelf IMH 60 / IMH 60-S / OMH 60 / OMH-S 60, including 2 shelf support brackets
50127774	Stainless steel perforated shelf IMH 100 / IMH 100-S / OMH 100 / OMH-S 100, including 2 shelf support brackets
50127777	Stainless steel perforated shelf IMH 180 / IMH 180-S / OMH 180 / OMH-S 180, including 2 shelf support brackets
50127914	Stainless steel perforated shelf OGS 60 / OGH 60 / OGH-S 60, including 2 shelf support brackets
50127925	Stainless steel perforated shelf OGS 100 / OGH 100 / OGH-S 100, including 2 shelf support brackets
50127926	Stainless steel perforated shelf OGS 180 / OGH 180 / OGH-S 180, including 2 shelf support brackets
50127861	Locking spring
50127862	Support rail Heratherm 60 L
50127863	Support rail Heratherm 100 L
50127864	Support rail Heratherm 180 L

Spare Parts and Accessories

Material No.	Description
50126665	Stacking adapter Heratherm 60 L
50126666	Stacking adapter Heratherm 100 L
50126667	Stacking adapter Heratherm 180 L
50127443	Levelling feet
50127767	Sample sensor OGH-S 60, OGH-S 100, OGH-S 180, OMH-S 60, OMH-S 100, OMH-S180
50127102	Kit fresh air filter Heratherm heating and drying ovens
50027662	Fresh air filter Heratherm heating and drying ovens

DOMINIQUE DUTSCHER SAS

Device Log

Oven type:			Part number:	
Serial number:			Service number:	
Location			Operator's note:	
Work carried out		Notes	Date	Signature

DOMINIQUE DUTSCHER SAS

Contact

Overview of Thermo Fisher International Sales Organization

Postal address USA:

Thermo Scientific
275 Aiken Road
Asheville, NC 28804
USA

Enquiries from USA/Canada

Sales: +1 866 984 3766
Service: +1 800 438 4851

Enquiries from Latin America

Sales: +1 866 984 3766
Service: +1 866 984 3766

Enquiries from Asia:

China

Sales: +86 10 8419 3588
Service: Toll free 8008105118
Support Mobile 4006505118
or +86 10 8419 3588

India

Sales: +91 22 6716 2200
Service: Toll free 1 800 22 8374
or +91 22 6716 2200

Japan

Sales: +81 45 453 9220
Service: +81 45 453 9224

Enquiries from the Rest of Asia/Australia/New Zealand

Sales: +852 2885 4613
Service: +65 6872 9720

Enquiries from Countries not listed / Rest of EMEA

Sales: +49 6184 90 6940
or +33 2 2803 2000
Service: +49 6184 90 6940

Contact

Enquiries from Europe:

Austria

Sales: +43 1 801 40 0

Service: +43 1 801 40 0

Belgium

Sales: +32 53 73 4241

Service: +32 53 73 4241

Finland/Nordic/Baltic countries

Sales: +358 9 329 100

Service: +358 9 329 100

France

Sales: +33 2 2803 2180

Service: +33 825 800 119

Germany:

Postal Address Germany:

Thermo Electron LED GmbH

Robert-Bosch-Straße 1

D - 63505 Langenselbold

Phone

Sales Toll free 0800 1 536 376

or +49 6184 90 6940

Service Toll free 0800 1 112110

or +49 6184 90 6940

E-Mail info.labequipment.de@thermofisher.com

Italy

Sales +39 02 95059 341

Service +39 02 95059 250

Netherlands

Sales +31 76 579 5555

Service +31 76 579 5639

Russia/CIS

Sales +7 812 703 4215

Service +7 812 703 4215

Spain/Portugal

Sales +34 93 223 0918

Service +34 93 223 0918

Switzerland

Service +41 44 454 1212

UK/Ireland

Service +44 870 609 9203

Sales +44 870 609 9203

DOMINIQUE DUTSCHER SAS

Thermo Fisher Scientific, Inc.
81 Wyman Street
P.O. Box 9046
Waltham, MA 02454-9046
United States

www.thermo.com

DOMINIQUE DUTSCHER SAS