

PHCbi

Operating Instructions

Biomedical Freezer

MDF-MU339HL

MDF-MU539HL Series



MDF-MU539HL

Please read the operating instructions carefully before using this product, and keep the operating instructions for future use.

See pages 35~36 for all model numbers.

CONTENTS

INTRODUCTION	3
PRECAUTIONS FOR SAFE OPERATION	4
SYMBOLS ON UNIT	9
ENVIRONMENTAL CONDITIONS	9
FREEZER COMPONENTS	
Main body	10
Control panel	12
INSTALLATION SITE	13
INSTALLATION	14
START-UP OF UNIT	16
TEMPERATURE SETTING	17
KEY LOCK FUNCTION	17
ALARM TEMPERATURE SETTING	18
SETTING OF ALARM DELAY TIME	19
SETTING OF ALARM RESUME TIME	20
SETTING OF ALARM BUZZER LINK MODE	21
CHANGE OF COMPRESSOR DELAY TIME	22
DURING/AFTER POWER FAILURE	23
REMOTE ALARM TERMINAL	23
ALARMS & SAFETY FUNCTIONS	24
ROUTINE MAINTENANCE	
Cleaning the exterior, interior, and accessories	25
Defrosting	25
CALIBRATION	26
REPLACEMENT OF WORN-OUT PARTS	
Replacement of the battery for the power-failure alarm	26
TROUBLESHOOTING	27
DISPOSAL OF UNIT	
Recycle of battery	28
Decontamination of unit	28
TEMPERATURE RECORDER (OPTION)	33
STORAGE CONTAINER (OPTION)	33
SPECIFICATIONS	34
PERFORMANCE	35
SAFETY CHECK SHEET	37

INTRODUCTION

- Read the operating instructions carefully before using the product and follow the instructions for safe operation.
- PHC Corporation takes no responsibility for safety if the product is not used as intended or is used with any procedures other than those given in the operating instructions.
- Keep the operating instructions in a suitable place so that they can be referred to as necessary.
- The operating instructions are subject to change without notice for improvement of performance or function.
- Contact our sales representative or agent if any page of the operating instructions is lost or the page order is incorrect, or if the instructions are unclear or inaccurate.
- No part of the operating instructions may be reproduced in any form without the express written permission of PHC Corporation.

IMPORTANT NOTICE

PHC Corporation. guarantees this product under certain warranty conditions. However, please note that PHC Corporation. Ltd. shall not be responsible for any loss or damage to the contents of the product.

<Intended Use>

This equipment is designed for low temperature storage of biomedical samples.

PRECAUTIONS FOR SAFE OPERATION

It is imperative that the user complies with the operating instructions as they contain important safety advice.

Items and procedures are described so that you can use this unit correctly and safely. Following these precautions will prevent possible injury to the user and any other person.

Precautions are illustrated in the following way:



WARNING

Warning indicates a potentially hazardous situation which, if not avoided, could result in serious injury or death.

CAUTION

Failure to observe CAUTION signs could result in injury to personnel and damage to the unit and associated property.













Symbols have the following meanings:

-  This symbol means caution.
-  This symbol means an action is prohibited.
-  This symbol means an instruction must be followed.

Be sure to keep the operating instructions in a place that is accessible to users of this unit.













PRECAUTIONS FOR SAFE OPERATION

WARNING

-  **Do not use the unit outdoors.** Exposure to rain may cause leakage and/or electric shock.
-  **Only qualified engineers or service personnel should install the unit.** Installation by unqualified personnel may cause electric shock or fire.
- Install the unit in a location capable of bearing the total combined weight (product + optional accessories + stored items). After installing the unit, be absolutely sure to take precautions to prevent the unit from falling over.** If the unit is installed in a location which is not strong enough or if the proper precautions are not taken, the unit may fall over and cause injuries.
-  **Turn the leveling feet to separate the casters from the floor and secure the unit.** If they are left touching the floor, the unit may inadvertently move out of position when its door is opened or closed. It may cause injury.
-  **Do not install the unit where there are high levels of moisture or where it may be splashed with water.** Installing the unit where there are high levels of moisture or where it may be splashed with water may cause the insulation to deteriorate and give rise to leakage and/or electric shock.
-  **Do not install the unit in a location where flammable or volatile substances are present.** Installing the unit in a location where flammable or volatile substances are present may cause explosions and/or a fire.
-  **Do not install the unit in a location where corrosive gases such as acids are present.** Installing the unit in a location where corrosive substances are present may cause electrical components to corrode, leading to leakage and/or electric shock due to the deterioration of insulation resulting from corroded electrical components.
-  **Do not place this unit in a location where it is difficult to disconnect the power supply plug.** Failure to disconnect the power supply plug may cause fire in the event of a problem or malfunction.
-  **Be absolutely sure to earth (ground) the unit to prevent electric shock.** Failure to earth the product may give rise to electric shock. If necessary, ask a qualified contractor to do this work.
-  **Do not connect the earth wire to a gas pipe, water pipe or lightning rod when earthing the unit.** Earthing the unit improperly may give rise to electric shock.
-  **Connect the unit to a power source as indicated on the rating label attached to the unit.** Use of any other voltage or frequency other than that on the rating label may cause fire or electric shock.
-  **Never store volatile or flammable substances in this unit except in a sealed container.** Such substances may cause explosion or fire if they leak.
-  **Never insert metal objects such as pins and wires into any vent, gap, or outlet on the unit.** This may cause electric shock or injury by accidental contact with moving parts.











PRECAUTIONS FOR SAFE OPERATION

WARNING

-  **When handling harmful samples (for example, those which consist of toxic, pathogenic or radioactive substances), install the unit inside a designated isolation facility.** If the unit is installed in a location which is not an isolation facility, there may be detrimental effects on both people and the natural environment.
-  **Before proceeding with maintenance or checking the unit, and disconnect the power supply plug.** Performing the work while power is still flowing to the product or while the power supply plug is still connected may give rise to electric shock and/or injury.
-  **Do not touch any electrical parts (such as power supply plug) or operate switches with a wet hand.** This may cause electric shock.
-  **Wear protective gloves and mask during maintenance.** Touching or inhaling chemicals or aerosols from around the unit may be detrimental to health.
-  **Never splash water directly onto the unit** as this may cause electric shock or short circuit.
-  **Never put containers with liquid on top of the unit** as this may cause electric shock or short circuit if the liquid is spilled.
-  **Never damage the power supply cord or power supply plug (by breaking, adapting, placing near a source of heat, bending with force, twisting, pulling, adding weight, or binding).** A damaged power supply cord or power supply plug may cause electric shock, short circuit, or fire
-  **Never disassemble, repair, or modify the unit yourself.** A high-voltage area is located inside the unit. Any work carried out by unauthorized personnel may result in electric shock. Contact our sales representative or agent for maintenance or repair.
-  **Make sure the power supply plug is pushed fully in.** Faulty insertion of the power supply plug may cause electric shock or fire due to generation of heat. Never use a damaged power supply plug or loose power supply outlet
-  **Disconnect the power supply plug if there is anything wrong with the unit.** Continued abnormal operation may cause electric shock or fire.
-  **Grip the power supply plug when disconnecting the power supply cord from the outlet.** Pulling the power supply cord may cause electric shock or short circuit.
-  **Do not pull the power supply cord, the power supply plug, or the product side plug (inlet part) hard.** If the cord breaks, it may cause electric shock or fire.







PRECAUTIONS FOR SAFE OPERATION

WARNING

-  **Remove dust from the power supply plug periodically.** Dust on the power supply plug may cause insulation failure due to moisture and thus cause a fire. Disconnect the power supply plug and wipe it with a dry cloth.
-  **Disconnect the power supply plug before moving the unit.** Take care not to damage the power supply cord. A damaged power supply cord may cause electric shock or fire.
-  **Disconnect the power supply cord when the unit is not in use for long periods.** Keeping the unit connected may cause electric shock, leakage, or fire due to the deterioration of insulation.
-  **Do not use power cord for other electrical equipment.** Such power supply cord may cause fire or electric shock.
-  **Always use the removal power supply cord.** Other power supply cord may cause electric shock or fire.
-  **If the unit is to be stored unused in an unsupervised area for a long period, ensure that children do not have access and that doors cannot be closed completely.**
-  **Ask a qualified contractor to carry out disassembly and disposal of the unit.** Leaving the unit in a location that can be accessed by third parties may result in unexpected accidents (e.g. the unit may be used for unintended purposes).
-  **Do not leave the plastic bags used for packing in a place where they can be reached by small children** as this may result in unexpected accidents such as suffocation.
-  **Never replace the battery for the power-failure alarm yourself.** Only qualified engineers or service personnel should replace the battery.
-  **When moving the unit, be sure to take precautions to prevent it from falling over.** Moving the unit with too much force may cause it to fall over, possibly resulting in injury. A qualified individual must be assigned to supervise the safe movement and relocation of the unit.
-  **Flammable and explosive product.** The unit contains flammable refrigerant. When repairing or recycling, only trained service personnel will repair and follow the procedure below.
 - Well ventilate the room to prevent refrigerant accumulation.
 - Keep fire away when the refrigerant is contained in the product.
 - Do not damage or break the pipework.





PRECAUTIONS FOR SAFE OPERATION

CAUTION

-  **Never install the unit in a location where corrosive materials such as sulphur compounds are likely to be generated (e.g. near a drainage facility).** Corrosion of the copper pipes may result in the deterioration and consequently the failure of the cooling unit.
-  **This unit must be plugged into a dedicated circuit protected by a branch circuit-breaker.**
-  **Use a dedicated power source as indicated on the rating label attached to the unit.** A multiple-tap source may cause fire due to excessive heating.
-  **Do not climb on top of the unit or put any objects on the unit.** Falling from the unit may cause injury; falling objects may cause damage to the unit
-  **Never store corrosive substances such as acids or alkalis in this unit except in a sealed container.** These may be harmful to your health and may cause corrosion of internal components or electrical parts.
-  **Check the settings when restarting operation after a power failure or after turning the power off.** The settings may have changed as a result of stopping the unit. Stored items inside the unit may be adversely affected when operation is resumed if the settings have changed.
-  **To ensure the safety of the service engineer, submit a safety check sheet with the required items filled out.** This is provided as the photocopyable “Safety Check Sheet” at the end of these operating instructions
-  **Do not touch the power supply joint of the temperature recorder(option).** It may cause electric shock.
-  **To prevent frostbite, wear protective gloves when handling frozen items in the chamber.** Too much frost may cause chamber temperature rise resulting from incomplete door close.
-  **Use designated parts for parts replacement.** Using an incorrect part may cause fire.
-  **Do not give strong shock or vibration during movement or use.** The piping may be damaged, causing a fire.
-  **Flammable and explosive product.** The unit contains flammable refrigerant. Consult repair manual/owner’s guide before attempting to install or service this product. All safety precautions must be followed.
-  **Flammable refrigerant used. Flammable and explosive product.** Dispose of properly in accordance with national regulations.

SYMBOLS ON UNIT

The following symbols are attached to the unit. The table describes the meaning of the symbols.

	This symbol is attached to covers that access high-voltage electrical components to prevent electric shock. Only a qualified engineer or service personnel should be allowed to open these covers.
	This symbol indicates that caution is required. Refer to product documentation for details.
	This symbol indicates an earth.
	This symbol indicates Incorrect usage could lead to a fire hazard.

ENVIRONMENTAL CONDITIONS

This equipment is designed to be safe at least under the following conditions (based on the IEC 61010-1):

- Indoor use;
- Altitude up to 2000 m;
- Ambient temperature 5 °C to 40 °C;
- Maximum relative humidity 80 % for temperature up to 31 °C decreasing linearly to 50 % relative humidity at 40 °C;
- Mains supply voltage fluctuations up to ± 10 % of the nominal voltage;
- Transient overvoltages up to the levels of OVERVOLTAGE CATEGORY II;
- Temporary OVERVOLTAGES occurring on the mains supply;
- Applicable pollution degree of the intended environment (POLLUTION DEGREE 2 in most cases)

FREEZER COMPONENTS

Main body

MDF-MU539HL

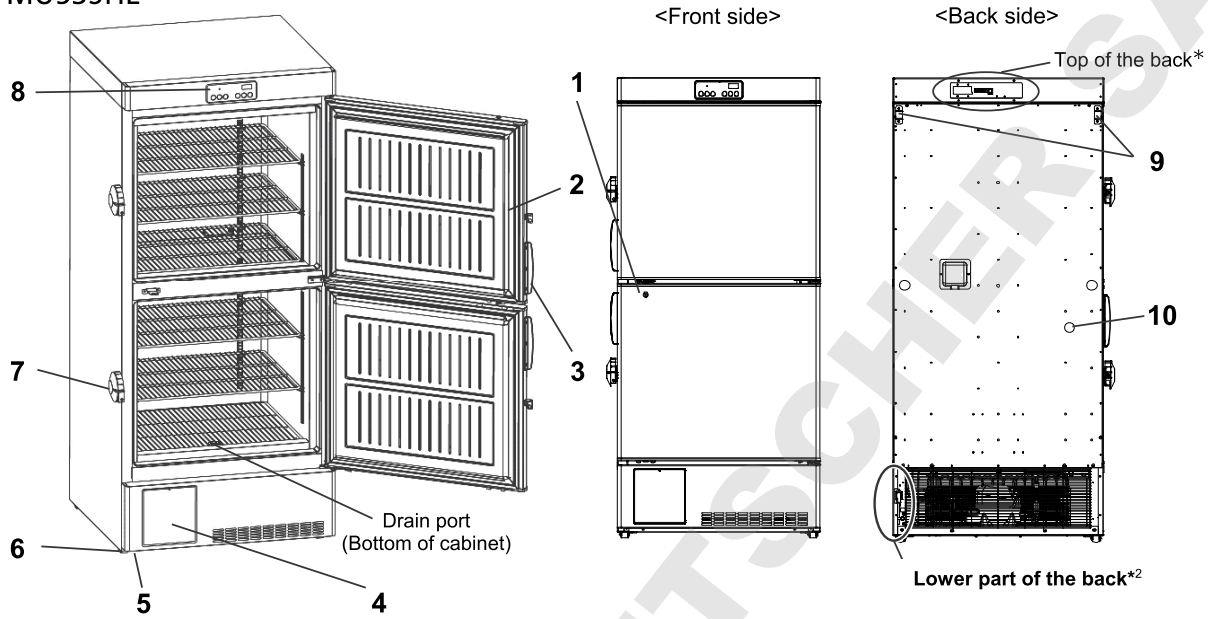

MDF-MU339HL

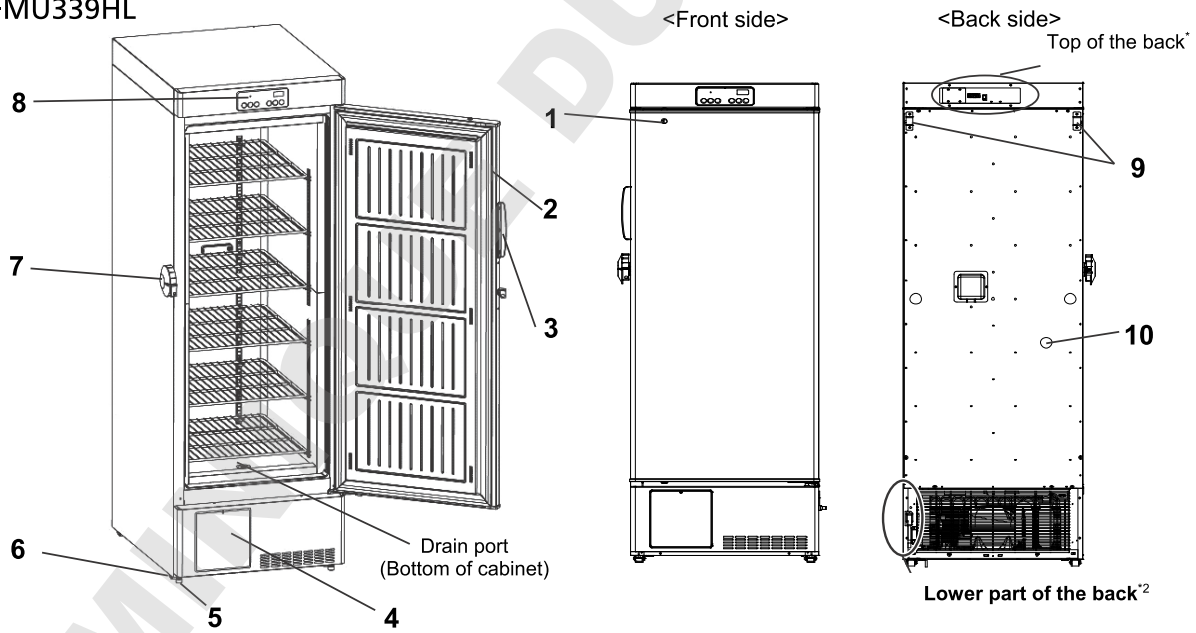

*: Top of the back

*2: Lower part of the back

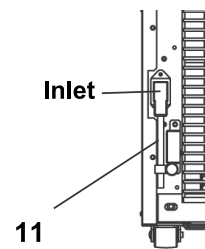
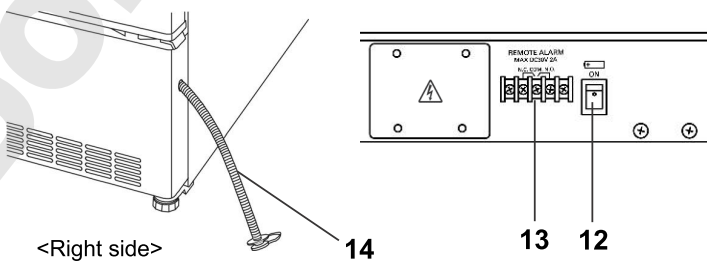

FREEZER COMPONENTS

- 1. Lock:** Turn counterclockwise to 180 ° with a key and the outer door is securely locked.
- 2. Door:** To open the door, grip the handle.
- 3. Handle:** Always grip this handle to open and close the outer door.
- 4. Space for temperature recorder:** A temperature recorder (optional component) can be attached here. See page 33 "TEMPERATURE RECORDER".
- 5. Levelling feet <bottom>:** These are screw bolts used to install and fix the unit. Adjust the height of the levelling feet by turning the screw bolts until the 2 front casters are away from the floor. See page 14.
- 6. Caster:** 4 casters are provided to facilitate moving of the cabinet. For the installation, adjust the leveling feet so that the front 2 casters cannot contact with the floor.
- 7. Door latch:** To lock the outer door, turn this latch downward. To unlock, rotate this latch up. A padlock is also available.
- 8. Control panel:** To display the temperature setting and running condition. See page 12.
- 9. Fixture (on back side):** 2 fixtures are provided as spacers between the cabinet and wall and also serve as hooks to fix the unit. See page 14.
- 10. Access port:** This is used for leading the measuring cable from the freezing chamber to the outside.
- 11. Power supply cord (inlet type):** Do not disconnect the power supply plug or the product side plug (inlet part) carelessly. If the power supply cord is disconnected, the contents of the chamber may be deteriorated.
- 12. Battery switch:** Switch for battery used for power failure alarm. Always keep "ON". Turn the switch "OFF" when the unit is in no use for a long period (more than 1 month).
- 13. Remote alarm terminal:** Used to notify an alarm condition of the unit to remote location. See page 23 "REMOTE ALARM TERMINAL".
- 14. Drain hose <Right side>:** The drain hose can be used to collect the defrosted water. See page 25.

FREEZER COMPONENTS

Control panel

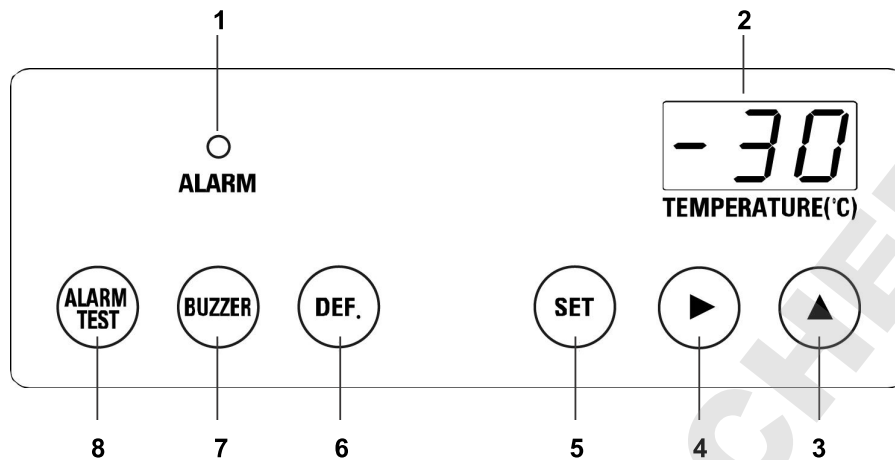

- 1. Alarm indicator (ALARM):** This lamp is flashed when the audible alarm is activated.
- 2. Digital temperature indicator:** Normally, the current chamber temperature is displayed in the temperature display. When the high/low temperature alarm is activated, the current chamber temperature blinks. When the self-diagnostic function detects an abnormality, the error code is displayed. See page 24.
- 3. Numerical value shift key (▲):** Pressing this key in the setting mode causes the numerical value to shift. ON-OFF of key lock can be selected by pressing this key in the key lock mode.
- 4. Digit shift key (▶):** Pressing this key in the setting mode causes the changeable digit to shift. Key lock mode is led by pressing this key for more than 5 seconds in the temperature display mode.
- 5. Set key (SET):** Temperature setting mode is led by pressing this key. Once the key is pressed, the changeable digit is flashed. Pressing this key again after setting desired temperature, the setting is stored into computer memory. If there is no key operation for 90 seconds during the setting mode, the setting mode is invalid automatically.
- 6. Defrost key (DEF):** When removing the frost, press this key for 5 seconds. The freezer operation is stopped. After removing the frost, press this key again. See page 25.
Note: The freezing operation never resumes automatically after defrosting.
- 7. Buzzer stop key (BUZZER):** To silence the audible alarm, press this key.
- 8. Alarm test key (ALARM TEST):** Test key for alarm device. By pressing this key, the alarm lamp is flashed, remote alarm is activated and buzzer sounds. This means all alarm function operate correctly.

INSTALLATION SITE

This unit must be installed in a location which meets all the conditions described below.

- If the unit is installed in a location which does not meet the conditions, its specified performance may not be achieved or malfunctions and accidents may occur.

■ A location not exposed to direct sunlight

Avoid any location which is exposed to direct sunlight. Installing the unit in a location exposed to direct sunlight may reduce its cooling performance.

■ A well-ventilated (airy) location

In order to ensure ventilation, leave clearances of at least 10 cm around the unit (at the left, right, top and back). Blocking the ventilation may reduce the unit's cooling performance or cause malfunctions.

■ A location away from sources of heat

Avoid any location which is close to a major source of heat (such as a heater or boiler). Installing the unit near a major source of heat may reduce the unit's cooling performance.

■ A location with minimal changes in temperature

Avoid any location where the ambient temperature is subject to sudden changes. If the unit is installed in a location where the ambient temperature is subject to sudden changes, it will not be possible to achieve a stable cooling performance. The ambient temperature to use is +5 °C degrees to +35 °C degrees.

■ A flat surface where the floor is also capable of bearing the total combined weight (product + optional accessories + stored items)

Install the unit on a flat surface which is even and which is capable of bearing the total combined weight (product + optional accessories + stored items). If the unit is installed where the surface is uneven or where the unit will be inclined at an angle, the unit will be unstable, and accidents or injuries may occur and/or unnecessary vibration or noise may be generated.

■ A location with minimal humidity

Install the unit in a location where the relative humidity is less than 80 %R.H. Installing the unit in a very humid location may cause earth faults and/or electric shock.

■ A location free of flammable or corrosive gases

Avoid any location exposed to flammable or corrosive gases. Flammable or corrosive gases can cause explosions and/or a fire. Furthermore, corrosion of the electrical parts may cause the insulation to be reduced and result in earth faults and/or electric shock.

■ A location where nothing can fall onto the unit

Avoid locations where objects may fall onto the unit. Objects falling and hitting the unit may cause it to break down or fail.

INSTALLATION

When installing the unit, follow the steps below to secure the unit properly, and also be absolutely sure to earth the unit.

1. Preparations after unpacking

Remove all the tape used to secure the doors and interior parts, and leave the doors open for a short while for ventilation.

If any surfaces of the outer cabinet are dirty, wipe the surface using a cloth moistened with a diluted neutral dish-washing detergent.

- Using an undiluted solution of detergent may cause the unit's plastic areas to crack. Follow the directions on the detergent for details of dilution.
- After wiping the unit using the diluted detergent, be absolutely sure to wipe the surfaces with a cloth dipped in clean water to remove traces of the detergent. After this, be absolutely sure to wipe the surfaces with a dry cloth, allowing the surfaces of the outer cabinet to dry out completely, and then proceed with the installation.

Note:

Remove the cable tie that bands the power supply cord. Prolonged contact with the tie may cause corrosion of the cord coating.

2. Securing and levelling the unit using the levelling feet

Rotate the front levelling feet clockwise until the casters are raised 5 mm to 10 mm above the floor surface [Fig. 1].

In addition, rotate the levelling feet slightly clockwise or anticlockwise, and adjust them so that the unit is completely level.

- When the casters are raised from the floor surface, the unit will be secured. If they are left touching the floor, the unit may accidentally move when its door is opened or closed.

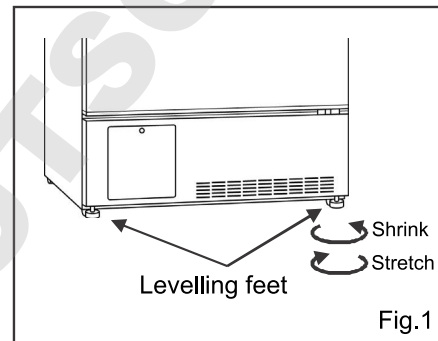

3. Fixing the unit

Two fixtures are attached to the rear of the unit. Fix the unit to the wall with these fixtures and rope or chain.

(Fig. 2)

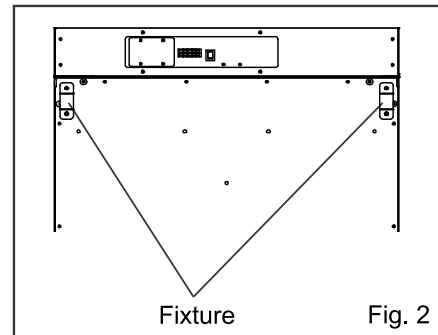

4. Ground (earth)

The ground (earth) is for preventing the electric shock in the case of the electrical insulation is somehow degraded. Always ground the unit at the time of installation.

- If the power supply outlet is not grounded, it will be necessary to install a ground by qualified engineers.

⚠ WARNING

Use a power supply outlet with ground (earth) to prevent electric shock. If the power supply outlet is not grounded, it is necessary to install a ground by qualified engineers.

Never ground the unit through a gas pipe, water main, telephone line or lightning rod. Such grounding may cause electric shock in the case of an incomplete circuit.

INSTALLATION

5. Installation of shelves

The shelves are packaged all together in the chamber. Set the shelves firmly in place on the shelf stoppers at the standard locations. (Fig. 3)

Note:

- Incomplete installation may cause injury or damage.

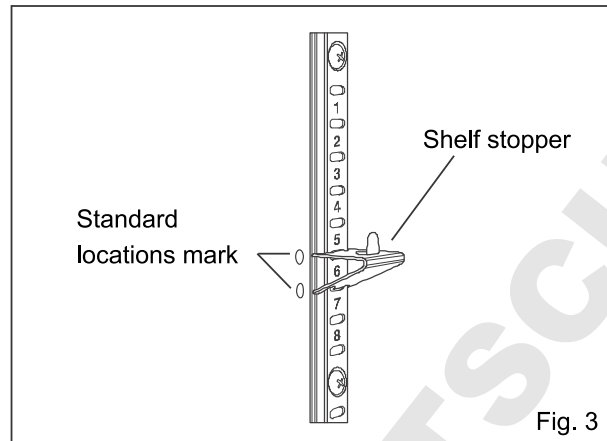

START-UP OF UNIT

Use the following procedure to start trial operation or actual operation of the unit.

1. In the empty state, power supply plug the plug into a power supply outlet. Confirm that the temperature display on the control panel is blinking.

2. Turn on the battery switch.

<Important>

Always turn the battery switch on when the unit is operating to ensure that the power-failure alarm is working.

3. Set the desired chamber temperature. See page 17 for the temperature setting.

4. Check that the chamber temperature reaches the desired temperature.

5. Make sure that the alarm lamp flashes and the buzzer sounds by pressing the alarm test key (ALARM TEST). The remote alarm is also operated. E09 is displayed on the digital temperature indicator and buzzer sounds if the battery switch is off. Make sure to turn on the battery switch.

6. After confirming the above, you can put articles into the biomedical freezer chamber in a small batch to prevent the temperature rise.

Note:

■ When starting the operation of the biomedical freezer for the first time, the alarm lamp (ALARM) lights. When the chamber temperature reaches around the set temperature, then the alarm lamp goes out (The remote alarm is activated).

■ If the battery switch is turned on before turning on the power of the biomedical freezer, the temperature alarm is activated and the buzzer sounds and the remote alarm is also activated. Check that the battery switch is off before turning on the biomedical freezer.

TEMPERATURE SETTING

Table 1 shows the basic procedure for setting the chamber temperature. Perform key operations in the sequence indicated in the table. The example in the table is based on the assumption that the desired temperature is -25 °C.

Note: The chamber temperature is set to -30 °C at the factory.

Table 1. Basic operation sequence (Example: Chamber temperature -25 °C)

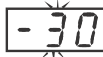
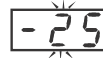
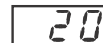
	Description of operation	Key operated	Indication after operation
1	Connect the power supply plug.	----	The current chamber temperature is displayed. 
2	Press set key.	SET	The second digit is flashed. 
3	Set to -25 with the numerical value shift key and digit shift key.	▶	When pressed, the settable digit is shifted.
		▲	When pressed, the figure of settable digit changes. 
4	Press set key.	SET	Set temperature is memorized and the current chamber temperature is displayed. 



- The chamber temperature can be set within the range of -35 °C to -18 °C, the ambient temperature is 35 °C and the guaranteed temperature is -30 °C at no load.
- The setting mode returns to the temperature display mode automatically when 90 seconds has passed without any key operation. In this case, any setting before pressing set key (SET) is not memorized.

KEY LOCK FUNCTION

This unit is provided with the key lock function. When the key lock is ON, change of temperature setting through the key pad is not possible. The key lock is set to OFF at the factory.

Display	Mode	Function
L 0	Key lock is OFF	Enable to change temperature setting
L 1	Key lock is ON	Disable to change temperature setting

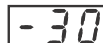
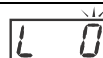
Table 2. Procedure for key lock setting (change from key lock OFF to key lock ON)

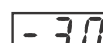
	Description of operation	Key operated	Indication after operation
1	----	----	The current chamber temperature is displayed. 
2	Press digit shift key for 5 seconds.	▶	The display changes to L 0 and the first digit blinks. 
3	Set the figure to L 1 by using numerical value shift key.	▲	When pressed, the figure of settable digit changes. 
4	Press set key.	SET	The key lock is set to ON. The current chamber temperature is displayed. 

- The setting mode returns to the temperature display mode automatically when 90 seconds has passed without any key operation. In this case, any setting before pressing set key (SET) is not memorized.

ALARM TEMPERATURE SETTING

This unit is provided with both high and low temperature alarms. The temperature at which the alarm is activated can be changed. The high temperature alarm can be set to a temperature of + 5 °C to + 15 °C. The low temperature alarm can be set to a temperature between -15 °C and -5 °C.

Note: The temperature alarm is set at ± 10 °C of the set temperature at the factory.

As an example, Table 3 shows the procedure to set the high temperature alarm so that the alarm can activate when the chamber temperature is 5 °C higher than the set temperature.

Table 4 shows the procedure to set the low temperature alarm so that the alarm can activate when the chamber temperature is 5 °C lower than the set temperature.

Table 3. Procedure for setting high temperature alarm

	Description of operation	Key operated	Indication after operation
1	----	----	The current chamber temperature is displayed.
2	Press numerical value shift key for about 5 seconds.	▲	The display changes to F00 and the first digit blinks.
3	Set the figure to F01 by using numerical value shift key	▲	When pressed, the figure of settable digit changes.
4	Press set key.	SET	The current setting is displayed and the first digit is flashed.
5	Set the figure to 005 by using digit shift key and numerical value shift key.	▶	When pressed, the settable digit is shifted.
		▲	When pressed, the figure of settable digit changes.
6	Press set key.	SET	Alarm temperature is memorized and the current chamber temperature is displayed.

Table 4. Procedure for setting low temperature alarm





	Description of operation	Key operated	Indication after operation
1	----	----	The current chamber temperature is displayed.
2	Press numerical value shift key for about 5 seconds.	▲	The display changes to F00 and the first digit blinks.
3	Set the figure to F02 by using numerical value shift key	▲	When pressed, the figure of settable digit changes.
4	Press set key.	SET	The current setting is displayed and the first digit is flashed.
5	Set the figure to -05 by using digit shift key and numerical value shift key.	▶	When pressed, the settable digit is shifted.
		▲	When pressed, the figure of settable digit changes.
6	Press set key.	SET	Alarm temperature is memorized and the current chamber temperature is displayed.

- The setting mode returns to the temperature display mode automatically when 90 seconds has passed without any key operation. In this case, any setting before pressing set key (SET) is not memorized.

SETTING OF ALARM DELAY TIME

The delay time of the buzzer and remote alarm for high and low temperature alarm can be set between 0 and 15 minutes. The procedure in table 5 shows the sequence to set the delay time to 10 minutes. The delay time is set to 15 minutes at the factory.

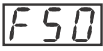
Table 5 Setting procedure for alarm delay time (change from 15 minutes to 10 minutes)

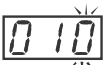
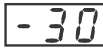
	Description of operation	Key operated	Indication after operation
1	----	----	The current chamber temperature is displayed. 
2	Press numerical value shift key for 5 seconds.	▲	The display changes to F00 and the first digit blinks.. 
3	Set the figure to F50 by using digit shift key and numerical value shift key.	▶	When pressed, the settable digit is shifted.
		▲	When pressed, the figure of settable digit changes. 
4	Press set key.	SET	The current delay time is displayed. The first digit is flashed. 
5	Set the figure to 010 by using numerical value shift key.	▲	When pressed, the figure of settable digit changes. 
6	Press set key.	SET	The delay time is memorized and the current chamber temperature is displayed. 

- The alarm delay time set mode returns to the temperature display mode automatically when 90 seconds has passed without any key operation.

SETTING OF ALARM RESUME TIME





The buzzer is cancelled by pressing buzzer stop key (BUZZER) on the control panel during alarm condition. However, if the alarm condition is continued after the “alarm resume time” has passed, the buzzer sounds again.

It is possible to change the alarm resume time by the procedure shown in the Table.6.

The example in the table is based on the assumption that the desired duration is 20 minutes.

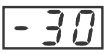
Note: Factory setting; 30 minutes.

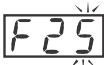
Table 6. Setting procedure for alarm resume time (change from 30 minutes to 20 minutes)

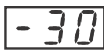
	Description of operation	Key operated	Indication after operation
1	---	---	The current chamber temperature is displayed. 
2	Press digit shift key for 5 seconds.	▲	The display changes to F00 and the first digit blinks.. 
3	Set the figure to F25 by using digit shift key and numerical value shift key.	▶	When pressed, the settable digit is shifted.
		▲	When pressed, the figure of settable digit changes. 
4	Press set key.	SET	The current resume time is displayed. The second digit is flashed. 
5	Set the figure to 020 by using numerical value shift key.	▲	When pressed, the figure of settable digit changes. 
6	Press set key.	SET	The setting is memorized and the current chamber temperature is displayed. 

- The settable alarm resume time are 10, 20, 30, 40, 50, or 60 minutes. The buzzer would not resume if the resume time is set in 000.





- The setting mode returns to the temperature display mode automatically when 90 seconds has passed without any key operation. In this case, any setting before pressing set key (SET) is not memorized.

SETTING OF ALARM BUZZER LINK MODE

Setting the alarm buzzer link mode enables the alarm buzzer and the remote buzzer to operate in conjunction / non-linking. Setting the alarm buzzer link mode is as follows in Table 7.

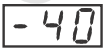
Note: Factory setting; non-linking "000".

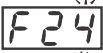
Table 7. Change procedure for link / non-link (changed from "000" to "001")

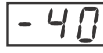
	Description of operation	Key operated	Indication after operation
1	-----	-----	The current chamber temperature is displayed. 
2	Press numerical value shift key for 5 seconds.	▲	The display changes to F00 and the first digit blinks. 
3	Set the figure to F24 by using digit shift key and numerical value shift key.	▶	When pressed, the settable digit is shifted.
		▲	When pressed, the figure of settable digit changes. 
4	Press set key.	SET	The current setting is displayed and the first digit is flashed. 
5	Set the figure to 001 by using numerical value shift key.	▲	When pressed, the figure of settable digit changes. 
6	Press set key.	SET	The setting is memorized and the current chamber temperature is displayed. 

- The alarm buzzer link mode returns to the temperature display mode automatically when 90 seconds has passed without any key operation.

CHANGE OF COMPRESSOR DELAY TIME





The delay time of the compressor can be changed to reduce the load on the power line and to facilitate the start-up (reset) of the freezer after power failure.

The example in the table is based on the assumption that the delay time is changed to 4 minutes. The delay time is set in 3 minutes at the factory.

Note:

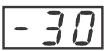
- The setting range for delay time is between 3 and 15 minutes. The cool down of chamber temperature may be slow when the setting of delay time is over 5 minutes, depending on the installation environment. There is no need of changing the delay time when the capacity of power source is adequate.

Table 8. Changing procedure for delay time (change from 3 minutes to 4 minutes)

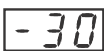
	Description of operation	Key operated	Indication after operation
1		----	The current chamber temperature is displayed. 
2	Press numerical value shift key for 5 seconds.	▲	The display changes to F00 and the first digit blinks. 
3	Set the figure to F05 by using numerical value shift key.	▲	When pressed, the figure of settable digit changes. 
4	Press set key.	SET	The current delay time is displayed. The first digit is flashed. 
5	Set the figure to 004 by using numerical value shift key.	▲	When pressed, the figure of settable digit changes. 
6	Press set key.	SET	The delay time is memorized and the current chamber temperature is displayed. 

- The compressor starts to run with the delay time when the power supply cord is connected to the outlet or after power failure.
- The compressor delay time set mode returns to the temperature display area mode automatically when 90 seconds has passed without any key operation.

DURING/AFTER POWER FAILURE

■ Display of chamber temperature during power failure

By depressing the buzzer stop key (BUZZER) during “power failure alarm”, the buzzer stop and the chamber temperature is displayed on the temperature display for 5 seconds. Then the buzzer is stopped. The alarm lamp keeps flashing.

◇ Check the chamber temperature as appropriate by depressing the buzzer stop key (BUZZER) during power failure.

<Important>

The battery for power failure alarm is a consumable part. Replace the battery about every 3 years. The alarm would not be activated at power failure if the battery is not replaced regularly. Contact our sales representative or agent for the replacement of battery.

■ Operation check after recovery from the power failure

The set value is memorized by nonvolatile memory. Accordingly, the freezer resumes the operation with setting before power failure.

When the freezer is recovered from power failure with the chamber temperature higher than the preset temperature, then the high temperature alarm is activated and the buzzer sounds and the remote alarm is also activated. Please push the buzzer stop key (BUZZER) to silence buzzer and take appropriate actions if needed.

REMOTE ALARM TERMINAL

The alarm is relayed to a remote location when a remote alarm device (commercially available) is connected to the remote alarm terminal. Installation of a remote alarm device is recommended when the unit is installed in an unattended location so that the operator of the unit is notified of the alarm.

■ Contact our sales representative or agent to arrange the installation of a remote alarm device.

The remote alarm terminal is installed at the back of the unit. The alarm is outputted from this terminal. Contact capacity is DC 30 V, 2 A.

Contact output:

Terminal	Normal status	Abnormal status
Between COM. and N.O.	open	close
Between COM. and N.C.	close	open

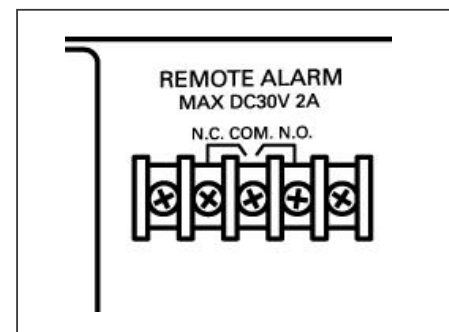

Note:

- The remote alarm terminal will be in alarm mode when the power supply cord is unplugged because this will be interpreted as a power failure.
- It is recommended to use standard signal and interface cables with a maximum length of 30 meters.

ALARMS & SAFETY FUNCTIONS

This unit has the alarms and safety functions shown in Table 9, and also self diagnostic functions.

Table 9 Alarms and safety functions

Indication		Situation	Alarm buzzer	Safety functions	Alarm
Digital temp. indicator	Alarm lamp				
Digital temperature indicator is flashed.	Flashed	If the chamber temperature is higher than the temperature at which the high temperature alarm is activated.	Intermittent tone with 15 minutes delay.	Remote alarm with 15 minutes delay.	High temperature alarm
		If the chamber temperature is lower than the temperature at which the low temperature alarm is activated.			Low temperature alarm
----		In the case of power failure. When the power to the unit is disconnected.	Intermittent tone	Remote alarm.	Power failure alarm
Chamber temperature is displayed.	-----	When there is no key pressing in each setting mode for 90 seconds.	-----	Finishing of each Setting mode.	Auto-return
-----		When the key lock is ON.		Change of setting is disable.	Key lock
E01 and chamber temp. are displayed alternately.	Flashed	If the thermal sensor is disconnected.	Intermittent tone	Remote alarm. Continuous running.	Thermal sensor abnormality
E02 and chamber temp. are displayed alternately.		If the thermal sensor is short-circuited.			
E03 and chamber temp. are displayed alternately.		If the condenser sensor is disconnected.		Remote alarm.	Sensor abnormality
E04 and chamber temp. are displayed alternately.		If the condenser sensor is short-circuited.			
E09 is flashed.		When battery switch is OFF at the time of alarm test.			
E10 and chamber temp. are displayed alternately.		In the event of failure of fan motor for cooling the compressor. When the ambient temperature exceeds the usable environmental condition, etc.		Remote alarm. Compressor stop (At about 78 ° C. or more)	Condenser temp. abnormality
E12 and chamber temp. are displayed alternately.		When an abnormality occurs in the rotational speed of the fan motor.		Remote alarm.	Fan motor abnormality
E14 and chamber temp. are displayed alternately.		When an abnormality occurs in the PFC circuit board.			Circuit board abnormality
E16 and chamber temp. are displayed alternately.		When an abnormality occurs in the inverter circuit board.			Circuit board abnormality
E18 and chamber temp. are displayed alternately.*		When an abnormality occurs in the partition heater.			Partition heater abnormality
F1 and chamber temp. are displayed alternately.	-----	When about 3 years has passed with the power ON.	-----	-----	Battery check

* : MDF-MU539HL only.

Note:

- The above power failure alarm is available when the battery switch is on and the battery is charged. If the battery switch is off or the battery is discharged, only the remote alarm is activated.
- The power failure alarm can be kept about 12 hours with the battery charged fully. 2-day operation of the freezer is needed to charge the battery full.

ROUTINE MAINTENANCE

WARNING

Always disconnect the power supply to the unit prior to any repair or maintenance of the unit in order to prevent electric shock or injury.

Cleaning the exterior, interior, and accessories

Use a dry cloth to wipe down the outside and inside of the unit and all accessories. If the outside panels are dirty, clean them with a diluted neutral dish-washing detergent.

Wipe off condensation from the exterior of the cabinet with a dry, soft cloth.

- Using an undiluted solution of detergent may cause the unit's plastic areas to crack. Follow the directions on the detergent for details of dilution.
- After the wiping the cabinet or accessories with a diluted detergent, be absolutely sure to wipe the surfaces with a cloth dipped in clean water to remove traces of the detergent. After this, be absolutely sure to wipe the surfaces with a dry cloth.

<Important>

- Never pour water onto or into the unit. Doing so can damage the electric insulation and cause failure.
- Do not use a brush, an acid, a thinner, laundry soap, a powder detergent, or boiling water for cleaning. These may cause damage to painted surfaces or cause perishing of plastic and rubber components. Moreover, do not wipe plastic and rubber components with a volatile material.
- In order to maintain the unit's intended level of performance, always replace accessories that have been removed for cleaning.

Defrosting

This product is refrigerated by the direct cooling. When it uses for a long time, frost appears on the chamber wall. It cannot be cooled down when there is much amount of frost. The defrost is mentioned in the following.

Use the scraper provided for removing the frost if the biomedical freezer operation must be continued. Pay attention not to impact or damage the inner wall.

1. When defrosting, temporarily move all the contents of storage containers in the biomedical freezer to another low-temperature freezer.
2. Remove the storage container and the shelf.
3. Press defrost key (DEF) for 5 seconds to stop the freezing operation. While the freezing operation is stopped, the current chamber temperature and dF are displayed on the digital temperature display alternately.
4. After a several hours, check visually that all frost was removed completely.
5. Use the drain hose to drain accumulated water. When draining, remove the cap attached to the bottom of the cabinet and the hose
6. Wipe off moisture remaining in the cabinet and return the hose and drain cap to their original positions.
7. Restore the storage container and the shelf.
8. Press defrost key (DEF) so that the freezing operation can be started.
9. Once the chamber temperature has dropped to the desired temperature, place the original contents back in the biomedical freezer chamber.

Note:

After the defrosting, the freezing operation is never resumed automatically. Make sure to press defrost key (DEF) to start the freezing operation after defrosting.

CALIBRATION

During continuous operation, the following service tasks must be performed:

- Perform a temperature calibration at least once a year.

For temperature calibration, contact our sales representative or agent.

REPLACEMENT OF WORN-OUT PARTS

Replacement of the battery for the power failure alarm

Replace the battery for the power failure alarm about every 3 years to ensure the alarm will operate in the event of a power failure. Contact our sales representative or agent to arrange the replacement of the battery.

■ The alarm function (blinking of alarm indicator, sounding of buzzer) will not operate when the battery for the power failure alarm is flat.

■ The alarm indicator blinks and the buzzer sound as a result of power from the battery for the power failure alarm. The regular replacement of the battery for the power failure alarm is important to prevent an increase in chamber temperature in the event of unexpected circumstances.

<Important>

The used battery is a recyclable resource. Do not dispose of the battery. Always follow the procedure for recycling.

TROUBLESHOOTING

If the unit malfunctions, check out the following before calling for service.

<Attention>

If the malfunction is not resolved after checking the following items or if the malfunction is not shown in the table below, contact our sales representative or agent.

Malfunction	Check/Remedy
Nothing operates even when the power supply plug is plugged in	<ul style="list-style-type: none"> <input type="checkbox"/> The unit is not connected to the power supply properly. <input type="checkbox"/> The capacity and voltage of the power supply is not sufficient. <input type="checkbox"/> There is a power failure. <input type="checkbox"/> The circuit breaker on the supply circuit is activated. <input type="checkbox"/> The fuse on the supply circuit is blown. <input type="checkbox"/> The power supply plug (inlet part) on the product side is not connected properly.
The alarm is activated during operation	<ul style="list-style-type: none"> <input type="checkbox"/> The unit is not connected to the power supply properly. <input type="checkbox"/> The capacity and voltage of the power supply is not sufficient. <input type="checkbox"/> There is a power failure. <input type="checkbox"/> The circuit breaker on the supply circuit is activated. <input type="checkbox"/> The fuse on the supply circuit is blown. <input type="checkbox"/> The chamber temperature setting has been changed. <input type="checkbox"/> The door has been kept open for a long time. <input type="checkbox"/> Containers with a high temperature (load) have been put in the chamber. <input type="checkbox"/> The door is open.
No key operation is available	<ul style="list-style-type: none"> <input type="checkbox"/> The key lock is set in ON (L 1). → Set the key lock in OFF (L 0).
During setting mode, the mode returns to temperature display mode	<ul style="list-style-type: none"> ■ The unit will return from setting mode to temperature display mode automatically after 90 seconds if no key is operated (auto-return function).
Excessive noise	<ul style="list-style-type: none"> <input type="checkbox"/> The floor is not stable. <input type="checkbox"/> The installation site is not level. <input type="checkbox"/> The freezer is tilted. <input type="checkbox"/> The cabinet is touching the surrounding wall.
The chamber does not get cold enough	<ul style="list-style-type: none"> <input type="checkbox"/> Warm material has been put in the chamber. <input type="checkbox"/> The door is frequently opened. <input type="checkbox"/> The chamber temperature setting is too high. <input type="checkbox"/> The unit is in direct sunlight. <input type="checkbox"/> The equipment is not installed in the appropriate place described in this instruction manual <input type="checkbox"/> The ventilation around the unit is blocked. <input type="checkbox"/> There is a nearby heat source. <input type="checkbox"/> The ambient temperature is too high. <input type="checkbox"/> There are too many items stored inside the chamber. <input type="checkbox"/> The access port is not covered. → The access port should be covered with insulation and rubber caps when not in use. <input type="checkbox"/> The door seal is damaged. → If it is damaged, contact our sales representative or agent for replacement. <input type="checkbox"/> A foreign substance is located between door gaskets.

DISPOSAL OF UNIT

WARNING

If the unit is to be stored unused in an unsupervised area for an extended period **ensure that children do not have access and doors cannot be closed completely.**

The disposal of the unit should be accomplished by appropriate personnel. Always remove doors to prevent accidents such as suffocation.

Recycle of battery

(Only for USA and CANADA)

A nickel metal hydride battery that is recyclable powers the product you have purchased. Please call 1-800-8-BATTERY for information on how to recycle this battery.

L'appareil que vous vous êtes procuré est alimenté par une pile au nickel-métal-hydrure (NiMH). Pour des renseignements sur le recyclage de la pile, veuillez composer le 1-800-8-BATTERY.



Use the specified charger.



Ni-MH



■ Label indication is obliged to comply with Japanese battery regulation.

■ Label indication is obliged to comply with Taiwanese battery regulation.

Decontamination of unit

Before disposing a biomedical freezer with biohazardous danger, decontaminate the biomedical freezer to the extent possible by the user

DISPOSAL OF UNIT

Disposal of Old Equipment and Batteries

Only for European Union and countries with recycling systems



These symbols on the products, packaging, and/or accompanying documents mean that used electrical and electronic products and batteries must not be mixed with general household waste.

For proper treatment, recovery and recycling of old products and used batteries, please take them to applicable collection points in accordance with your national legislation.

By disposing of them correctly, you will help to save valuable resources and prevent any potential negative effects on human health and the environment.

For more information about collection and recycling, please contact your local municipality.

Penalties may be applicable for incorrect disposal of this waste, in accordance with national legislation.

Note for the battery symbol (bottom symbol):

This symbol might be used in combination with a chemical symbol. In this case it complies with the requirement set by the Directive for the chemical involved.



Likvidácia opotrebovaných zariadení a batérií

Len pre Európsku úniu a krajiny so systémom recyklácie



Tieto symboly uvádzané na výrobkoch, balení a/alebo v sprievodnej dokumentácii informujú o tom, že opotrebované elektrické a elektronické výrobky a batérie sa nesmú likvidovať ako bežný domový odpad.

V záujme zabezpečenia správneho spôsobu likvidácie, spracovania a recyklácie odovzdajte opotrebované výrobky a batérie na špecializovanom zbernom mieste v súlade s platnou legislatívou.

Správnym spôsobom likvidácie týchto výrobkov a batérií prispějete k zachovaniu cenných zdrojov a predídete prípadným negatívnym dopadom na ľudské zdravie a životné prostredie.

Podrobnejšie informácie o zbere a recyklácii vám poskytnú miestne úrady.

Pri nesprávnej likvidácii tohto druhu odpadu môžu byť v súlade s platnou legislatívou udelené pokuty.

Poznámka týkajúca sa symbolu batérie (spodný symbol):

Tento symbol môže byť použitý spolu so symbolom chemickej značky. V takom prípade vyhovuje požiadavke stanovenej Smernicou týkajúcou sa príslušnej chemikálie.



Изхвърляне на излезли от употреба електрически и електронни уреди и батерии

Само за Европейския съюз и страните със системи за рециклиране



Този символ върху продуктите, опаковката и/или придружаващите документи означава, че изразходваните електрически и електронни продукти и батериите не бива да се изхвърлят в общите битови отпадъци.

Моля, предавайте старите продукти и изхабените батерии за обработка, преработка и рециклиране на компетентните пунктове за събиране на отпадъци съгласно законовите разпоредби.

Като изхвърляте тези продукти и батериите правилно, Вие помагате за запазване на ценни ресурси и за избягване на евентуално вредните влияния върху човешкото здраве и околната среда.

За повече информация относно събирането и рециклирането се обърнете към Вашето предприятие на място, предлагащо услуги във връзка с изхвърлянето на отпадъците.

Съгласно разпоредбите в страната за неправилно изхвърляне на тези отпадъци могат да бъдат наложени парични глоби.

Указание за символа батерия (символ долу):

Този символ може да е изобразен в комбинация с химически символ. В този случай това се прави поради изискванията на директивите, издадени за съответния химикал.



Tájékoztató felhasználók számára az elhasználtott készülékek, szárazelemek és akkumulátorok begyűjtéséről és ártalmatlanításáról.

Csak az Európai Unió és olyan országok részére, amelyek begyűjtő rendszerrel rendelkeznek



A termékeken, a csomagoláson és/vagy a kísérő dokumentumokon szereplő szimbólumok azt jelentik, hogy az elhasználtott elektromos és elektronikus termékeket, szárazelemeket és akkumulátorokat tilos az általános háztartási hulladékkal keverni.

Az elhasználtott készülékek, szárazelemek és akkumulátorok megfelelő kezelése, hasznosítása és újrafelhasználása céljából, kérjük, hogy a helyi törvényeknek, megfelelően juttassa el azokat a kijelölt gyűjtőhelyekre.

E termékek, szárazelemek és akkumulátorok előírászerű ártalmatlanításával Ön hozzájárul az értékes erőforrások megóvásához, és megakadályozza az emberi egészség és a környezet károsodását.

Amennyiben a begyűjtéssel és újrafelhasználással kapcsolatban további kérdése lenne, kérjük, érdeklődjön a helyi önkormányzatnál.

E hulladékok szabálytalan elhelyezését a nemzeti jogszabályok büntethetik.

Megjegyzés a szárazelem- és akkumulátor-szimbólummal kapcsolatban (alsó szimbólumpélda):

Ezek a szimbólumok kémiai szimbólummal együtt alkalmazhatók. Ebben az esetben teljesíti az EU irányelvnek vegyi anyagra vonatkozó követelményét.



Pozbywanie się zużytych urządzeń elektrycznych i elektronicznych oraz baterii.

Dotyczy wyłącznie obszaru Unii Europejskiej oraz krajów posiadających systemy zbiórki i recyklingu.



Niniejsze symbole umieszczane na produktach, opakowaniach i/lub w dokumentacji towarzyszącej oznaczają, że nie wolno mieszać zużytych urządzeń elektrycznych i elektronicznych oraz baterii z innymi odpadami domowymi/komunalnymi.

W celu zapewnienia właściwego przetwarzania, utylizacji oraz recyklingu zużytych urządzeń elektrycznych i elektronicznych oraz zużytych baterii, należy oddawać je do wyznaczonych punktów gromadzenia odpadów zgodnie z przepisami prawa krajowego.

Poprzez prawidłowe pozbywanie się zużytych urządzeń elektrycznych i elektronicznych oraz zużytych baterii pomagasz oszczędzać cenne zasoby naturalne oraz zapobiegać potencjalnemu negatywnemu wpływowi na zdrowie człowieka oraz na stan środowiska naturalnego.

W celu uzyskania informacji o zbiórce oraz recyklingu zużytych urządzeń elektrycznych i elektronicznych oraz baterii prosimy o kontakt z władzami lokalnymi.

Za niewłaściwe pozbywanie się tych odpadów mogą grozić kary przewidziane przepisami prawa krajowego.

Dotyczy symbolu baterii (symbol poniżej):

Ten symbol może występować wraz z symbolem pierwiastka chemicznego. W takim przypadku wymagania Dyrektywy w sprawie określonego środka chemicznego są spełnione.



Pomembna informacija za pravilno odstranjevanje izrabljene opreme in baterij

Samoz za države EU in države, kjer imajo vzpostavljen sistem recikliranja odpadnih snovi



Simboli na samem izdelku, embalaži ali spremljajočih dokumentih pomenijo, da po koncu življenjske dobe aparata, z njim ni dovoljeno ravnavati kot z drugimi gospodinjskimi odpadki.

Vaša dolžnost je, da izrabljeno opremo ali napravo ter baterijske vložke predate v odstranjevanje na posebna zbirna mesta za ločeno zbiranje odpadkov v okviru vaše lokalne skupnosti oziroma zastopniku, ki opravlja dejavnost prevzemanja odpadne električne in elektronske opreme.

S tem, ko jih pravilno odstranite (recikliranje in sortiranje nevarnih odpadkov) varujete naše življenje okolje ter preprečujete negativni vpliv na naravo okrog nas, na naše življenje pomembne vire in vode.

Za dodatne informacije o zbiranju in recikliranju, prosim kontaktirajte vašo lokalno skupnost.

Nepravilno odstranjevanje nevarnih in izrabljenih snovi ter naprav je lahko kaznivo dejanje.

Obvestilo za baterijski simbol (spodnji simbol):



Ta simbol se uporablja v kombinaciji s kemičnim simbolom. V takšnem primeru odgovarja zahtevi, ki jo določa direktiva za določeno kemikalijo.



DISPOSAL OF UNIT

<p>Likvidace použitých zařízení a baterií Jen pro státy Evropské unie a země s fungujícím systémem recyklace a zpracování odpadu.</p>  <p>Tyto symboly na výrobcích, jejich obalech a v doprovodné dokumentaci upozorňují na to, že se použítá elektrická a elektronická zařízení, včetně baterií, nesmějí likvidovat jako běžný komunální odpad.</p> <p>Aby byla zajištěna správná likvidace a recyklace použitých výrobků a baterií, odevzdávejte je v souladu s národní legislativou na příslušných sběrných místech.</p> <p>Správnou likvidaci přispějete k úspoře cenných přírodních zdrojů a předejdete možným negativním dopadům na lidské zdraví a životní prostředí.</p> <p>O další podrobnosti o sběru a recyklaci odpadu požádejte místní úřady.</p> <p>Při nesprávné likvidaci tohoto druhu odpadu se vystavujete postihu podle národní legislativy.</p> <p>Poznámka k symbolu baterie (značka pod symbolem): Tento symbol může být použitý v kombinaci s chemickou značkou. Takový případ je souladu s požadavky směrnice pro chemické látky.</p>	<p>Vanhojen laitteiden ja paristojen hävittäminen Vain EU-jäsenmaille ja kierrätysjärjestelmää käyttäville maille</p>  <p>Tämä symboli tuotteissa, pakkauksessa ja/tai asiakirjoissa tarkoittaa, että käytettyjä sähköllä toimivia ja elektronisia tuotteita ei saa laittaa yleisiin talousjätteisiin.</p> <p>Johda vanhat tuotteet ja käytetyt paristot käsittelyä, uusiointia tai kierrätystä varten vastaaviin keräyspisteisiin laissa annettujen määräysten mukaisesti.</p> <p>Hävittämällä tuotteet asiaankuuluvasti, autat samalla suojaamaan arvokkaita luonnonvaroja ja estämään mahdollisia negatiivisia vaikutuksia ihmiseen ja luontoon.</p> <p>Lisätietoa keräämisestä ja kierrätyksestä saa paikalliselta jätehuollosta vastuulliselta viranomaiselta.</p> <p>Maiden lainsäädännön mukaisesti tämän jätteen määräystenvastaisesta hävittämisestä voidaan antaa sakkorangaistuksia.</p> <p>Huomautus paristosymbolista (symboli alhaalla): Tämä symboli voidaan näyttää jonkin kemiallisen symbolin yhteydessä. Siinä tapauksessa se perustuu vastaaviin direktiiveihin, jotka on annettu kyseessä olevalle kemikaalille.</p>
<p>Eski Ekipman ve Bataryaların Tasfiyesi Sadece Avrupa Birliği ve geri dönüşüm sistemleri olan ülkeler için</p>  <p>Ürünlerin, ambalajın ve/veya ek olarak gelen belgelerin üzerindeki bu semboller, elektrikli ve elektronik ürünlerin ve bataryaların genel ev atıklarıyla karıştırılmaması gerektiği anlamına gelir.</p> <p>Eski ürünlerin ve kullanılan bataryaların doğru şekilde işlenmesi, geri kazanımı ve geri dönüşümü için lütfen bunları ulusal kanunlara uygun olan toplama noktalarına götürün.</p> <p>Bunları doğru şekilde tasfiye ederek değerli kaynakları kurtarmaya ve insan sağlığı ve çevre üzerinde oluşabilecek olumsuz etkileri önlemeye yardım edeceksiniz.</p> <p>Toplama ve geri dönüşüm hakkında daha fazla bilgi için lütfen bölgenizdeki belediye ile irtibat kurun.</p> <p>Bu atığın yanlış şekilde tasfiye edilmesi durumunda ulusal kanunlar uyarınca cezalar verilebilir.</p> <p>Batarya sembolüne bakın (alttaki sembol): Bu sembol bir kimyasal sembolü ile birlikte kullanılmış olabilir. Bu durumda batarya, kullanılan kimyasal maddeye yönelik Direktif ile belirlenen şartı karşılıyordu.</p>	<p>Entsorgung von Altgeräten und Batterien Nur für die Europäische Union und Länder mit Recyclingsystemen</p>  <p>Dieses Symbol, auf den Produkten, der Verpackung und/oder den Begleitdokumenten, bedeutet, dass gebrauchte elektrische und elektronische Produkte sowie Batterien nicht in den allgemeinen Hausmüll gegeben werden dürfen.</p> <p>Bitte führen Sie alte Produkte und verbrauchte Batterien zur Behandlung, Aufarbeitung bzw. zum Recycling gemäß den gesetzlichen Bestimmungen den zuständigen Sammelpunkten zu. Endnutzer sind in Deutschland gesetzlich zur Rückgabe von Altbatterien an einer geeigneten Annahmestelle verpflichtet. Batterien können im Handelsgeschäft unentgeltlich zurückgegeben werden.</p> <p>Indem Sie diese Produkte und Batterien ordnungsgemäß entsorgen, helfen Sie dabei, wertvolle Ressourcen zu schützen und eventuelle negative Auswirkungen auf die menschliche Gesundheit und die Umwelt zu vermeiden.</p> <p>Für mehr Informationen zu Sammlung und Recycling, wenden Sie sich bitte an Ihren örtlichen Abfallentsorgungsdienstleister.</p> <p>Gemäß Landesvorschriften können wegen nicht ordnungsgemäßer Entsorgung dieses Abfalls Strafgeelder verhängt werden.</p> <p>Hinweis für das Batteriesymbol (Symbol unten): Dieses Symbol kann in Kombination mit einem chemischen Symbol abgebildet sein. In diesem Fall erfolgt dieses auf Grund der Anforderungen derjenigen Richtlinien, die für die betreffende Chemikalie erlassen wurden.</p>
<p>L'élimination des équipements et des batteries usagés Applicable uniquement dans les pays membres de l'Union européenne et les pays disposant de systèmes de recyclage.</p>  <p>Apposé sur le produit lui-même, sur son emballage, ou figurant dans la documentation qui l'accompagne, ce pictogramme indique que les piles, appareils électriques et électroniques usagés, doivent être séparées des ordures ménagères.</p> <p>Afin de permettre le traitement, la valorisation et le recyclage adéquats des piles et des appareils usagés, veuillez les porter à l'un des points de collecte prévus, conformément à la législation nationale en vigueur.</p> <p>En les éliminant conformément à la réglementation en vigueur, vous contribuez à éviter le gaspillage de ressources précieuses ainsi qu'à protéger la santé humaine et l'environnement.</p> <p>Pour de plus amples renseignements sur la collecte et le recyclage, veuillez vous renseigner auprès des collectivités locales.</p> <p>Le non-respect de la réglementation relative à l'élimination des déchets est passible d'une peine d'amende.</p> <p>Note relative au pictogramme à apposer sur les piles (pictogramme du bas) : Si ce pictogramme est combiné avec un symbole chimique, il répond également aux exigences posées par la Directive relative au produit chimique concerné.</p>	<p>Eliminación de Aparatos Viejos y de Pilas y Baterías Solamente para la Unión Europea y países con sistemas de reciclado.</p>  <p>Estos símbolos en los productos, su embalaje o en los documentos que los acompañen significan que los productos eléctricos y electrónicos y pilas y baterías usadas no deben mezclarse con los residuos domésticos.</p> <p>Para el adecuado tratamiento, recuperación y reciclaje de los productos viejos y pilas y baterías usadas llévelos a los puntos de recogida de acuerdo con su legislación nacional.</p> <p>En España, los usuarios están obligados a entregar las pilas en los correspondientes puntos de recogida. En cualquier caso, la entrega por los usuarios será sin coste alguno para éstos. El coste de la gestión medioambiental de los residuos de pilas, acumuladores y baterías está incluido en el precio de venta.</p> <p>Si los elimina correctamente ayudará a preservar valuosos recursos y evitará potenciales efectos negativos sobre la salud de las personas y sobre el medio ambiente.</p> <p>Para más información sobre la recogida u reciclaje, por favor contacte con su ayuntamiento.</p> <p>Puede haber sanciones por una incorrecta eliminación de este residuo, de acuerdo con la legislación nacional.</p> <p>Note para el símbolo de pilas y baterías (símbolo debajo): Este símbolo puede usarse en combinación con el símbolo químico. En este caso, cumple con los requisitos de la Directiva del producto químico indicado.</p>

DISPOSAL OF UNIT

<p>Smaltimento di vecchie apparecchiature e batterie usate Solo per Unione Europea e Nazioni con sistemi di raccolta e smaltimento</p>  <p>Questi simboli sui prodotti, sull'imballaggio e/o sulle documentazioni o manuali accompagnanti i prodotti indicano che i prodotti elettrici, elettronici e le batterie usate non devono essere buttati nei rifiuti domestici generici.</p> <p>Per un trattamento adeguato, recupero e riciclaggio di vecchi prodotti e batterie usate vi invitiamo a portarli negli appositi punti di raccolta secondo la legislazione vigente nel vostro paese.</p> <p>Con uno smaltimento corretto, contribuirete a salvare importanti risorse e ad evitare i potenziali effetti negativi sulla salute umana e sull'ambiente.</p> <p>Per ulteriori informazioni su raccolta e riciclaggio, vi invitiamo a contattare il vostro comune.</p> <p>Lo smaltimento non corretto di questi rifiuti potrebbe comportare sanzioni in accordo con la legislazione nazionale.</p> <p>Note per il simbolo batterie (simbolo sotto): Questo simbolo può essere usato in combinazione con un simbolo chimico. In questo caso è conforme ai requisiti indicati dalla Direttiva per il prodotto chimico in questione.</p>	<p>Eliminação de Equipamentos Usados e Baterias Apenas para a União Europeia e países com sistemas de reciclagem</p>  <p>Estes símbolos nos produtos, embalagens, e/ou documentos que os acompanham indicam que os produtos elétricos e eletrônicos e as baterias usados não podem ser misturados com os resíduos urbanos indiferenciados.</p> <p>Para um tratamento adequado, reutilização e reciclagem de produtos e baterias usados, solicitamos que os coloque em pontos de recolha próprios, em conformidade com a respetiva legislação nacional.</p> <p>Ao eliminar estes produtos corretamente estará a ajudar a poupar recursos valiosos e a prevenir quaisquer potenciais efeitos negativos sobre o ambiente e a saúde humana.</p> <p>Para mais informações acerca da recolha e reciclagem, por favor contacte a sua autarquia local.</p> <p>De acordo com a legislação nacional podem ser aplicadas contraordenações pela eliminação incorreta destes resíduos.</p> <p>Nota para o símbolo da bateria (símbolo na parte inferior): Este símbolo pode ser utilizado conjuntamente com um símbolo químico. Neste caso estará em conformidade com o estabelecido na Diretiva referente aos produtos químicos em causa.</p>
<p>Depunerea la deșeurile a echipamentelor și a bateriilor vechi Doar pentru Uniunea Europeană și pentru țările cu sisteme de reciclare</p>  <p>Aceste simboluri de pe produse, ambalaje și/sau documentele însoțitoare indică faptul că produsele electrice și electronice, precum și bateriile uzate nu trebuie să fie amestecate cu deșeurile menajere obișnuite.</p> <p>Pentru un tratament corespunzător, pentru recuperarea și reciclarea produselor vechi și a bateriilor uzate, vă rugăm să le depuneți la punctele de colectare special amenajate, în conformitate cu legislația națională.</p> <p>Prin depunerea corespunzătoare a acestora la deșeurile, veți ajuta la economisirea unor resurse valoroase și veți preveni potențiale efecte negative asupra sănătății umane și asupra mediului înconjurător.</p> <p>Pentru mai multe informații despre colectare și reciclare, vă rugăm să contactați autoritățile locale.</p> <p>Este posibil ca depunerea incorectă la deșeurile să fie pedepsită în conformitate cu legile naționale.</p> <p>Notă pentru simbolul de baterie (ultimele două exemple de simboluri): Acest simbol poate fi utilizat în combinație cu un simbol chimic. În acest caz, acesta este conform cu cerințele stabilite de Directivă pentru elementul chimic în cauză.</p>	<p>Indsamling af elektroniskrot og brugte batterier Kun for Den Europæiske Union og lande med retursystemer</p>  <p>Disse symboler på produkter, emballage og/eller ledsagedokumenter betyder, at brugte elektriske og elektroniske produkter og batterier ikke må blandes med almindeligt husholdningsaffald.</p> <p>For korrekt behandling, indsamling og genbrug af gamle produkter og batterier, skal du tage dem til indsamlingssteder i overensstemmelse med den nationale lovgivning.</p> <p>Ved at skaffe sig af med dem på korrekt vis hjælper du med til at spare værdifulde ressourcer og forhindre eventuelle negative påvirkninger af menneskers sundhed og miljøet.</p> <p>Ønsker du mere udførlig information om indsamling og genbrug skal du kontakte din kommune.</p> <p>Usagkyndig bortskaffelse af elektroniskrot og batterier kan eventuelt udløse bødeforlæggelse.</p> <p>Information om batterisymbol (eksempler nedenfor): Dette symbol kan anvendes sammen med et kemisk symbol. I så fald opfylder det kravene for det direktiv, som er blevet fastlagt for det pågældende kemikalie.</p>
<p>Senų prietaisų ir akumuliatorių utilizavimas Taikoma tik Europos Sąjungai ir šalims, kuriose naudojamas perdirbimo sistemos</p>  <p>Jei ant pakuotės ir (arba) lydimousiųose dokumentuose nurodytas šis simbolis, vadinasi, naudotų elektrinių ir elektroninių gaminių ir akumuliatorių negalima išmesti kartu įprastomis buitiniams atliekomis.</p> <p>Senus produktus ir naudotus akumuliatorius perduokite apdirbti, likviduoti arba perdirbti kompetentingiems surinkimo punktam pagal įstatymų galios potvarkius.</p> <p>Šiuos gaminius ir akumuliatorius perdavę tinkamai utilizuoti, padėsite išsaugoti vertingus išteklius ir išvengti neigiamo poveikio žmogaus sveikatai ir aplinkai.</p> <p>Jei norite gauti daugiau informacijos apie surinkimą ir perdirbimą, kreipkitės į vietos atliekų utilizavimo paslaugų teikėją.</p> <p>Remiantis šalyje galiojančiais potvarkiais, už netinkamą tokių atliekų utilizavimą gali būti skirta bauda.</p> <p>Akumuliatoriaus simbolio nuoroda (simbolis apačioje): Kartu su šiuo simboliu gali būti pateiktas cheminių medžiagų simbolis. Šis simbolis pateikiamas, kai būtina laikytis atitinkamiems chemikalams taikomų direktyvų reikalavimų.</p>	<p>Rimi ta' Taghmir Antik u Batteriji Għall-Unjoni Ewropea u għall-pajjiżi b'sistemi ta' riċiklaġġ biss</p>  <p>Dawn is-simboli fuq il-prodotti, l-imballaġġ u/jew id-dokumenti ta' akkumpanjament ifissru li prodotti elettrici u elettronici u batteriji użati ma jridux jiġu mħallta ma' skart domestiku ġenerali.</p> <p>Għal trattament, irkupru u riċiklaġġ xieraq ta' prodotti antik u batteriji użati, jekk jogħġbok hudhom f'punti tal-ġbir applikabbli f'konformità mal-leġiżlazzjoni nazzjonali tiegħek.</p> <p>Billi tarmihom b'mod xieraq, tgħin sabieħ tikkonserva riżorsi preżjużi u tippreveni kwalunkwe effett negattiv potenzjali fuq is-saħħa tal-bniedem u l-ambjent.</p> <p>Għal aktar informazzjoni dwar il-ġbir u r-riċiklaġġ, jekk jogħġbok ikkuntattja lill-muniċipalitá lokali tiegħek.</p> <p>F'każ ta' rimi mhux korrett ta' dan l-iskart jistgħu japplikaw penali, f'konformità mal-leġiżlazzjoni nazzjonali.</p> <p>Nota għas-simbolu tal-batterija (simbolu ta' taħt): Dan is-simbolu jista' jintuża f'kombinazzjoni ma' simbolu tal-kimika. F'dan il-każ jikkonforma mar-rekwiżit stabbilit mid-Direttiva għall-kimika involuta.</p>
<p>Zbrinjavanje starih uređaja i baterija Samo za Europsku uniju i zemlje koje posjeduju sustav recikliranja</p>  <p>Ovaj simbol na proizvodima, pakiranju i/ili popratnim dokumentima znači da se iskorišteni električni i elektronički proizvodi te baterije ne smiju bacati u kućanski otpad.</p> <p>Molimo vas da prema zakonskim odredbama stare proizvodne i istrošene baterije predate na ovlaštenim sabiralištima na daljnju obradu, pripremu odn. recikliranje.</p> <p>Ako te proizvode i baterije propisno zbrinete, pomožete pri zaštiti dragocjenih resursa, a istovremeno i izbjegavate eventualne negativne utjecaje na ljudsko zdravlje i okoliš.</p> <p>Za više informacija o zbrinjavanju i recikliranju obratite se svojem lokalnom komunalnom poduzeću.</p> <p>Zbog nepropisnog zbrinjavanja ovog otpada mogu se, ovisno o lokalnim propisima zemlje, izreći i novčane kazne.</p> <p>Napomena za simbol baterije : Ovaj simbol može biti prikazan samo u kombinaciji s kemijskim simbolom. U tom se slučaju upotrebljava na temelju zahtjeva onih direktiva koje su donesene za dotičnu kemikaliju.</p>	

DISPOSAL OF UNIT

<p>Avfallshantering av produkter och batterier Endast för Europeiska Unionen och länder med återvinningssystem</p>   <p>Dessa symboler på produkter, förpackningar och/eller medföljande dokument betyder att förbrukade elektriska och elektroniska produkter och batterier inte får blandas med vanliga hushållsopor.</p> <p>För att gamla produkter och använda batterier ska hanteras och återvinnas på rätt sätt ska dom lämnas till passande uppsamlingsställe i enlighet med nationella bestämmelser.</p> <p>Genom att ta göra det korrekt hjälper du till att spara värdefulla resurser och förhindrar eventuella negativa effekter på människors hälsa och på miljön.</p> <p>För mer information om insamling och återvinning kontakta din kommun.</p> <p>Olämplig avfallshantering kan beläggas med böter i enlighet med nationella bestämmelser.</p> <p>Notering till batterisymbolen (nedanför): Denna symbol kan användas i kombination med en kemisk symbol. I detta fall uppfyller den de krav som ställs i direktivet för den aktuella kemikalien.</p>	<p>Brukerinformasjon om innsamling av gammelt utstyr og brukte batterier Bare for EU og land med retursystemer</p>   <p>Slike symboler på produkter, emballasje, og/eller på medfølgende dokumenter betyr at brukte elektriske/elektroniske produkter og batterier ikke må blandes med vanlig husholdningsavfall.</p> <p>For riktig håndtering og gjenvinning av gamle produkter og brukte batterier, vennligst lever dem til innsamlingssteder i samsvar med nasjonallovgivning.</p> <p>Ved riktig håndtering av disse produktene og batteriene, hjelper du til med å spare verdifulle ressurser og forhindre potensielle negative effekter på menneskers helse og miljø.</p> <p>For mer informasjon om innsamling og gjenvinning vennligst ta kontakt med din kommune.</p> <p>Ukorrekt håndtering av dette avfallet kan medføre straffansvar, i overensstemmelse med nasjonal lovgivning.</p> <p>Merknader for batterisymbolen (nederste symbol): Dette symbolet kan bli brukt i kombinasjon med et kjemisk symbol. I dette tilfellet etterkommer det kravet satt av direktivet for det kjemikaliet det gjelder.</p>
<p>Het otdoen van oude apparatuur en batterijen. Enkel voor de Europese Unie en landen met recycle systemen.</p>   <p>Deze symbolen op de producten, verpakkingen en/of begeleidende documenten betekenen dat gebruikte elektrische en elektronische producten en batterijen niet samen mogen worden weggegooid met de rest van het huishoudelijk afval.</p> <p>Voor een juiste verwerking, hergebruik en recycling van oude producten en batterijen, gelieve deze in te leveren bij de desbetreffende inleverpunten in overeenstemming met uw nationale wetgeving.</p> <p>Door ze op de juiste wijze weg te gooien, helpt u mee met het besparen van kostbare hulpbronnen en voorkomt u potentiële negatieve effecten op de volksgezondheid en het milieu.</p> <p>Voor meer informatie over inzameling en recycling kunt u contact opnemen met uw plaatselijke gemeente.</p> <p>Afhankelijk van uw nationale wetgeving kunnen er boetes worden opgelegd bij het onjuist weggooien van dit soort afval.</p> <p>Let op: het batterij symbool (Onderstaand symbool). Dit symbool kan in combinatie met een chemisch symbool gebruikt worden. In dit geval volstaan de eisen, die zijn vastgesteld in de richtlijnen van de desbetreffende chemische stof.</p>	<p>Απόρριψη παλαιών συσκευιών και μπαταριών Μόνο για την Ευρωπαϊκή Ένωση και χώρες με συστήματα ανακύκλωσης</p>   <p>Το σύμβολο αυτό, πάνω στα προϊόντα, τη συσκευασία ή/και τα συνοδευτικά έγγραφα, υποδηλώνει ότι τα χρησιμοποιημένα ηλεκτρικά και ηλεκτρονικά προϊόντα, καθώς και οι μπαταρίες, δεν πρέπει να απορρίπτονται στα κοινά οικιακά απορρίμματα.</p> <p>Παρακαλούμε παραδώστε τα παλαιά προϊόντα και τις χρησιμοποιημένες μπαταρίες για διαχείριση, επεξεργασία ή/και ανακύκλωση σύμφωνα με τις νομικές διατάξεις των αρμόδιων αρχών αποκομιδής.</p> <p>Με την ορθή απόρριψη αυτών των προϊόντων και μπαταριών, συμβάλλετε στην εξοικονόμηση πολύτιμων πόρων και την αποφυγή τυχόν αρνητικών επιπτώσεων στην ανθρώπινη υγεία και το περιβάλλον.</p> <p>Για περισσότερες πληροφορίες σχετικά με τη συλλογή και την ανακύκλωση, παρακαλούμε απευθυνθείτε στις κατά τόπους υπηρεσίες συγκομιδής απορριμμάτων.</p> <p>Σε περίπτωση αντικανονικής απόρριψης αυτού του προϊόντος ενδεχομένως να επιβληθούν πρόστιμα, ανάλογα με τη νομοθεσία του εκάστοτε κράτους.</p> <p>Σημείωση για το σύμβολο μπαταρίας (σύμβολο κάτω): Το σύμβολο αυτό μπορεί να απεικονίζεται σε συνδυασμό με ένα χημικό σύμβολο. Αυτό γίνεται ώστε να υπάρχει συμφωνία με τις απαιτήσεις των εκάστοτε οδηγιών, που εκδόθηκαν για το εν λόγω χημικό.</p>
<p>Nolietoto elektronisko ierīču un elektropreču un bateriju utilizācija Tikai Eiropas valstīs ar utilizācijas sistēmu</p>   <p>Šis simbols, kas izvietots uz ražojumiem, iesaiņojuma un/vai pavaddokumentiem nozīmē, ka nolietotās elektroniskās ierīces un elektropreces, kā arī baterijas nedrīkst izmest kopā ar parastiem mājsaimniecības atkritumiem.</p> <p>Nogādājiet nolietotos ražojumus un nokalpojums baterijas tālākai apstrādei, pārstrādei, resp., materiālu atreizējai pārstrādei attiecīgajās atkritumu savākšanas vietās saskaņā spēkā esošajām likumdošanas prasībām.</p> <p>Nododot šos ražojumus un baterijas profesionālai utilizācijai, jūs palīdzēsiet saudzēt vērtīgus resursus un novērsīsiet iespējamu kaitējumu cilvēku veselībai un apkārtnē.</p> <p>Lai iegūtu plašāku informāciju par atkritumu savākšanu un otrreizējo pārstrādi, lūdzam vērsties savā vietējā atkritumu pārstrādes uzņēmumā.</p> <p>Saskaņā ar nacionālo likumdošanu par nepareizu šāda veida atkritumu utilizāciju var uzlikt naudas sodu.</p> <p>Norāde par baterijas simbolu (simbols apakšā): Šis simbols var būt attēlots kombinācijā ar ķīmiskās vielas simbolu. Tādā gadījumā tas ir apzīmēts atbilstoši attiecīgo Direktīvu prasībām, kas pieņemtas attiecībā uz attiecīgo ķīmikāliju.</p>	<p>Уклањање старих апарата и батерија Само за Европску Унију и државе са системима рециклирања</p>   <p>Овај симбол на производима, паковању и/или пратећим документима значи да коришћени електрични и електронски апарати не смеју бити бачени у обично кућно ђубре.</p> <p>Молимо да сходно законским одредбама однесете старе производе и искоришћене батерије у надлежна сабирна места на третман, прераду, односно рециклирање.</p> <p>Тиме што ћете ове производе и батерије правилно уклонити помажете да се притом заштите вредни ресурси и избегну евентуална негативна дејства на људско здравље и човеку околинау.</p> <p>Молимо да се за више информација у вези сакупљања и рециклирања обратите Вашој месној служби за уклањање отпада.</p> <p>За непрописно уклањање овог отпада могу бити изречене новчане казне према прописима државе.</p> <p>Упутство за симбол за батерију (симбол доле): Овај симбол може бити илустрован у комбинацији са хемијским симболом. У том случају ово следи на основу захтева оних смерница које су донешене за дотичне хемикалије.</p>
<p>Vanade seadmete ja patareide jäätmekäitlus Ainult Euroopa Liidule ja ringlussevõtu süsteemidega riikidele</p>   <p>Toodetel, pakendil ja/või kaasasolevatel dokumentidel olevad sümbolid tähendavad, et elektri- ja elektroonikatooteid ja patareid ei tohi visata tavaliste olmejäätmete hulka.</p> <p>Vanade toodete ja kasutatud patareide nõuetekohaseks töötlemiseks, taastamiseks ja ringlusse võtmiseks viige need ettenähtud kogumiskohtadesse vastavalt riiklikele õigusaktidele.</p> <p>Nende toodete ja patareide korrektse kõrvaldamisega aitate säasta hinnalisi ressursse ning vältida võimalikke kahjulikke mõjusid inimeste tervisele ja keskkonnale.</p> <p>Täpsema teabe saamiseks kogumise ja ringlussevõtu kohta pöörduge kohaliku omavalitsuse poole.</p> <p>Vastavalt riiklikele õigusaktidele võib selliste jäätmete ebakorrektsel käitlemisega kaasned trahv.</p> <p>Märkus patarei sümboli kohta : Seda sümbolit võib kasutada kombinatsioonil keemilise sümboliga. Sellisel juhul vastab see asjaomasele kemikaali kasutamist reguleeriva direktiivi nõuetele.</p>	

TEMPERATURE RECORDER (OPTION)

The chamber temperature can be monitored and recorded by installing an optional temperature recorder. For the installation of a temperature recorder, an optional recorder fixing is necessary.

- For the attachment of a temperature recorder, contact our sales representative or agent.
- For the usage of the temperature recorder, also refer to an installation sheet enclosed with the temperature recorder.

Main specifications of temperature recorder

	MTR-G85A (Power source:AC110-120 V) MTR-G85C (Power source:AC200-240 V)	MTR-4015LH
Recording range	Between -100 °C and +40 °C	Between -40 °C and +14 °C
Feed speed of recording paper	1-day/turn, 7-day/turn, 32-day/turn	31-day/batch
Recording paper	Circular type	Strip type
Power source	Supplied from the biomedical freezer	Dry cell
Recorder fixing(Optional)	MPR-S7	MPR-S30

STORAGE CONTAINER (OPTION)

	MDF-03SC	MDF-05SC
Usage model	MDF-MU339HL	MDF-MU539HL
Inner dimensions	W420 mm x D552 mm x H157 mm	W280 mm x D552 mm x H157 mm
Material	ABS plastic	
Package	2 pcs/set	

- Be careful not to damage the storage container by the scraper when removing the frost.
- Be careful not to drop the storage container from the shelf during use.

SPECIFICATIONS

Product name	Biomedical Freezer MDF-MU339HL	Biomedical Freezer MDF-MU539HL
External dimensions	W616 mm x D770 mm x H1802 mm	W793 mm x D770 mm x H1802 mm
Internal dimensions	W472 mm x D614 mm x H1262 mm	W649 mm x D614 mm x H1262 mm
Effective capacity	369 L	504 L
Exterior	Painted steel	
Interior	Painted steel	
Insulation	Rigid polyurethane foamed-in place	
Outer door	Painted steel	
Shelf	Made of hard steel wire + PE coating : 6 pcs Load; 30 kg/shelf	
Evaporator	Tube on sheet type (Liner combined use)	
Access port	Diameter 30 mm, 1 on back side	
Condenser	Wire and tube type	
Compressor	Hermetic type, 400 W	
Refrigerant	R-290	
Temperature controller	Microcomputer control system	
Temperature display	Digital display (between -50 °C and +50 °C)	
Temperature sensor	Thermistor sensor	
Temperature alarm	Flash of digital temperature indicator and alarm lamp, Buzzer, (Remote alarm)	
Remote alarm contact	Allowable contact capacity: DC 30 V, 2 A *1	
Accessories	Key 1 set, Defrost spatula 1 pc	
Weight	122 kg	144 kg
Battery	For power failure alarm, Nickel-metal-hydride battery, DC 6 V, 1100 mAh, Automatic charge	
Optional component	Temperature recorder (MTR-G85A, MTR-G85C)+Recorder fixing (MPR-S7), Temperature recorder (MTR-4015LH)+ Recorder fixing (MPR-S30) Interface board (MTR-480, MTR-L03) *1, *2	
	Storage container : 2 pcs/set (MDF-03SC)	Storage container: 2 pcs/set (MDF-05SC)

*1: It is recommended to use standard signal and interface cables with a maximum length of 30 meters.

*2: For the data acquisition system MTR-5000 user only. Contact our sales representative or agent for purchase.

Note:

- Design or specifications are subject to change without notice.
- Refer to the updated catalogue when ordering an optional component.

PERFORMANCE

Product name	Biomedical Freezer MDF-MU339HL	
Model number	MDF-MU339HL-PA	MDF-MU339HL-PE
Cooling performance	-30 °C (ambient temperature; 35 °C, no load)	
Temperature control range	-30 °C to -20 °C	
Rated voltage	AC 115 V	AC 220 V/230 V/240 V
Rated frequency	60 Hz	50 Hz
Rated power consumption	100 W	100 W
	Max. 230 W	Max. 230 W
Noise level	42 dB [A] (background noise; 20 dB)	
Maximum pressure	1.7 MPa	
Usable environment condition	Temperature; 5 °C to 35 °C Humidity; equal or less than 80 %R.H.	

- The unit with CE mark complies with EU directives.

Product name	Biomedical Freezer MDF-MU339HL		
Model number	MDF-MU339HL-PS	MDF-MU339HL-PK	MDF-MU339HL-PR
Cooling performance	-30 °C (ambient temperature; 35 °C, no load)		
Temperature control range	-30 °C to -20 °C		
Rated voltage	AC 230 V	AC 220 V	AC 220 V/230 V
Rated frequency	50 Hz	60 Hz	60 Hz
Rated power consumption	100 W	100 W	100 W
	Max. 230 W	Max. 230 W	Max. 230 W
Noise level	42 dB [A] (background noise; 20 dB)		
Maximum pressure	1.7 MPa		
Usable environment condition	Temperature; 5 °C to 35 °C Humidity; equal or less than 80 %R.H.		

- The unit with CE mark complies with EU directives.

PERFORMANCE

Product name	Biomedical Freezer MDF-MU539HL	
Model number	MDF-MU539HL-PA	MDF-MU539HL-PE
Cooling performance	-30 °C (ambient temperature; 35 °C, no load)	
Temperature control range	-30 °C to -20 °C	
Rated voltage	AC 115 V	AC 220 V/230 V/240 V
Rated frequency	60 Hz	50 Hz
Rated power consumption	140 W	140 W
	Max. 230 W	Max. 230 W
Noise level	42 dB [A] (background noise; 20 dB)	
Maximum pressure	1.8 MPa	
Usable environment condition	Temperature; 5 °C to 35 °C Humidity; equal or less than 80 %R.H.	

- The unit with CE mark complies with EU directives.

Product name	Biomedical Freezer MDF-MU539HL		
Model number	MDF-MU539HL-PS	MDF-MU539HL-PK	MDF-MU539HL-PR
Cooling performance	-30 °C (ambient temperature; 35 °C, no load)		
Temperature control range	-30 °C to -20 °C		
Rated voltage	AC 230 V	AC 220 V	AC 220 V/230 V
Rated frequency	50 Hz	60 Hz	60 Hz
Rated power consumption	140 W	140 W	140 W
	Max. 230 W	Max. 230 W	Max. 230 W
Noise level	42 dB [A] (background noise; 20 dB)		
Maximum pressure	1.8 MPa		
Usable environment condition	Temperature; 5 °C to 35 °C Humidity; equal or less than 80 %R.H.		

- The unit with CE mark complies with EU directives.

CAUTION

Please fill in this form before servicing.
Hand over this form to the service engineer to keep for his and your safety.

Safety check sheet

1. Freezer contents :

- Risk of infection: Yes No
Risk of toxicity: Yes No
Risk from radioactive sources: Yes No

(List all potentially hazardous materials that have been stored in this unit.)

Notes :

2. Contamination of the unit

Unit interior

- No contamination Yes No
Decontaminated Yes No
Contaminated Yes No
Others:

3. Instructions for safe repair/maintenance/disposal of the unit

- a) The unit is safe to work on Yes No
b) There is some danger (see below) Yes No

Procedure to be adhered to in order to reduce safety risk indicated in b) below.

Date :

Signature :

Address, Division :

Telephone :

Product name: Biomedical Freezer	Model: MDF-	Serial number:	Date of installation:
-------------------------------------	----------------	----------------	-----------------------

Please decontaminate the unit yourself before calling the service engineer.

DOMINIQUE DUTSCHER SAS

DOMINIQUE DUTSCHER SAS

PHC Corporation

1-1-1 Sakada, Oizumi-machi, Ora-gun, Gunma 370-0596, Japan

© PHC Corporation 2019



Printed in Indonesia
LDCL062700-2
N0319-21119