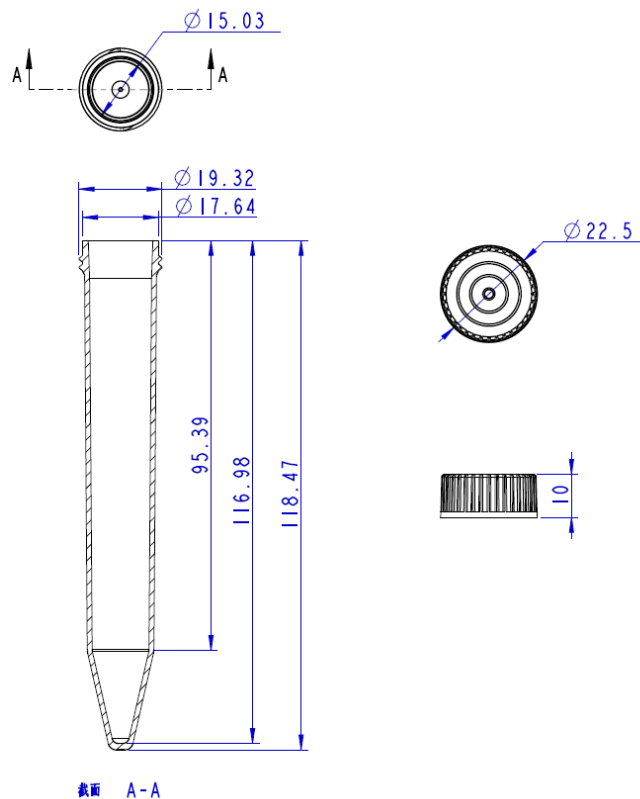

ClearLine centrifuge tubes

Polypropylene tube
Dnase, Rnase free / endotoxine free / PCR inhibitor free / non cytotoxique /pyrogen free
Polyethylene cap
Bidirectional grading
Bottom tube graduations
Max freeze level
Marking surface
Sterile (SAL 10-6)
Conical bottom
Autoclavable (max. °C) 121°C
Max centrifugation speed : 15 000 g
Perfect Leakproof: at -95kPa (14psi)
Maximum accuracy of graduations at $\pm 2\%$
Volume (ml) : 15
Packaging : Bulk, bag of 25 tubes

**Units :**

500