

# TurboQ Real-Time PCR System

TCRT-9614 / TCRT-9624

## Operation Manual

Ver 1.1



Copyright © 2026 Blue-Ray Biotech Corp.  
All Rights Reserved.

# Table of Contents

<b>1. Safety Precautions</b> .....	<b>1</b>
1.1 Safety Label .....	1
1.2 General Instrument Safety.....	1
1.3 Chemical Safety .....	3
1.4 Chemical Waste Safety .....	4
1.5 Electrical Safety.....	4
<b>2. General Description</b> .....	<b>5</b>
2.1 Features .....	5
2.2 Product Overview .....	6
<b>3. Getting Started</b> .....	<b>8</b>
3.1 Unpacking .....	8
3.2 Environmental Requirements .....	8
3.3 Electric Power Requirements .....	9
3.4 Power On/Off.....	9
3.5 Front Door (for Service Engineer Only).....	9
3.6 Tray In/Out .....	10
3.7 Loading the Reaction Vessel .....	10
<b>4. User Interface</b> .....	<b>11</b>
4.1 Starting the TurboQ Program .....	11
4.2 Navigating the Program.....	11
4.3 View Selection.....	12
4.4 Home View.....	12
4.5 Instrument Status .....	13
<b>5. Protocols</b> .....	<b>14</b>
5.1 Creating a New Protocol.....	15
5.2 Protocol Properties .....	16
5.3 Cycle Stage .....	17
5.4 Melt Curve Stage.....	20
5.5 Importing Protocols.....	20
<b>6. Plate Layout</b> .....	<b>21</b>
6.1 Creating a Layout .....	22
6.2 Sample Type .....	23
6.3 Dilution Series .....	24
6.4 Grouping Samples.....	24

6.5 Importing and Exporting Layouts .....	24
<b>7. Executing an Experiment .....</b>	<b>25</b>
7.1 Executing an Existing Experiment .....	25
<b>8. Monitoring a Run.....</b>	<b>26</b>
8.1 Adding Reagents During a Run .....	27
<b>9. Analysis.....</b>	<b>28</b>
9.1 Run Log.....	28
9.2 Adding Analyses.....	29
9.3 Analyzing Sample Groups .....	30
9.4 Exporting Analyses.....	30
<b>10. Ct and Absolute Quantification.....</b>	<b>31</b>
10.1 Adding an Absolute Quantification Analysis.....	32
10.2 Graphs .....	33
10.3 Settings .....	33
10.4 Baseline .....	33
10.5 Threshold Ct.....	34
10.6 Individual Ct.....	35
10.7 Results .....	36
<b>11. Relative Quantification .....</b>	<b>37</b>
11.1 Adding a Relative Quantification Analysis.....	39
11.2 Amplification Efficiency .....	39
11.3 Settings .....	39
11.4 Results .....	40
<b>12. Allelic Discrimination.....</b>	<b>41</b>
12.1 Layout Creation for Allelic Discrimination.....	42
12.2 Adding an Allelic Discrimination Analysis.....	42
12.3 Settings .....	42
<b>13. Melt Curve .....</b>	<b>43</b>
13.1 Adding a Melt Curve Analysis .....	45
13.2 Settings .....	45
13.3 Results .....	45
<b>14. High Resolution Melt Analysis .....</b>	<b>46</b>
14.1 Adding an HRM Analysis .....	48
14.2 HRM Analysis and Results .....	48

<b>15. Settings</b> .....	<b>49</b>
15.1 Default Path.....	49
15.2 Language .....	50
15.3 Lid Pre-Heat .....	50
<b>Appendix A: Technical Specifications</b> .....	<b>51</b>
<b>Appendix B: CE Declaration</b> .....	<b>53</b>
<b>Appendix C: Order Information</b> .....	<b>54</b>

DOMINIQUE DUTSCHER SAS

# 1. Safety Precautions

The **TurboQ** Real-Time PCR System is intended for use in research laboratories by professional personnel.

This manual covers the use of **TurboQ** Software in conjunction with the **TurboQ** Real-Time PCR System. It has been designed to give you the information you need:

- Install **TurboQ** Real-Time PCR System
- Operate the software
- Adjust the software settings
- Analyze the data

Read the manual in its entirety before using the system. Keep the manual for future reference. The manual is an important part of the system and should be readily available.

For the latest information on products and services, visit our website at:

<https://www.blue-raybio.com/>

In our efforts to produce useful and appropriate documentation, we would appreciate any comments you might make about this user manual to our local representative.

## 1.1 Safety Label



**High Temperature Label for Halogen Lamp:** The halogen lamp can become very hot after operation. Please be aware of this fact.



**Warning Label:** Please be aware of the danger of electric shock or other accident.

## 1.2 General Instrument Safety

**PHYSICAL INJURY HAZARD.** Use of the instrument in a manner, or for purposes not specified by Blue-Ray Biotech, may result in personal injury or damage to the instrument.

### 1.2.1 Transportation and Storage

This instrument should be transported or stored in an environment with a temperature of -20 ~ 60 °C, relative humidity 20 ~ 80%.

### 1.2.2 Installation and Operation

1. Do not use the device in a potentially explosive environment or with potentially explosive chemicals.
2. Install the device in a location free of excessive dust.
3. Avoid placing the device in direct sunlight.
4. Choose a flat, stable surface capable of bearing the weight of the device.
5. Install the device in a place where the temperature range is 15 ~ 30°C and the relative humidity is 20 ~ 80%.
6. **MAKE SURE** the air vents are unobstructed.
7. Keep the front and rear of the device at least 10 cm from a wall or other equipment.
8. Make sure the power source conforms to the required power supply specifications.
9. To avoid electric shock, make sure the device is plugged into a grounded electrical outlet.
10. Do not allow water or any foreign matter to enter the various openings of the device.

### 1.2.3 Cleaning, Decontamination and Service of the Instrument

Before using a cleaning or decontamination method other than recommended by the manufacturer, check with the manufacturer to ensure that the proposed method is safe for use with the equipment.

Switch off the mains and unplug the device before cleaning, servicing, or replacing the fuses.

Repairs should be carried out by authorized service personnel only.

### 1.2.4 Instructions for Disposal

**Do not dispose of this product as unsorted municipal waste.** Follow local municipal waste ordinances for proper disposal provisions to reduce the environmental impact of waste electrical and electronic equipment (WEEE).

#### **European Union customers:**

Call your local Blue-Ray Biotech Customer Service office for equipment pick-up and recycling.

## 1.3 Chemical Safety

### 1.3.1 Chemical Hazard Warning

**CHEMICAL HAZARD.** Before handling any chemicals, refer to the Material Safety Data Sheet (MSDS) provided by the manufacturer, and observe all the relevant precautions.

### 1.3.2 About MSDSs

Chemical manufacturers supply current Material Safety Data Sheets (MSDSs) with shipments of hazardous chemicals to new customers. They also provide MSDSs with the first shipment of a hazardous chemical to a customer after an MSDS has been updated. MSDSs provide all the safety information you need about the storage, handling, transport, and safe disposal of chemicals.

Each time you receive a new MSDS packaged with a hazardous chemical, be sure to replace the appropriate MSDS in your files.

### 1.3.3 Chemical Safety Guidelines

To minimize the hazards of chemicals:

- Read and understand the Material Safety Data Sheets (MSDSs) provided by the chemical manufacturer before you store, handle, or work with any chemicals or hazardous materials. (See **“About MSDSs” in Section 1.4.2**)
- Minimize contact with chemicals. Use the appropriate personal protection when handling chemicals (for example, safety glasses, gloves, or protective clothing). For additional safety guidelines, consult the MSDS.
- Minimize the inhalation of chemical vapor. Do not leave chemical containers open. Use only with adequate ventilation (for example, inside a fume hood). For additional safety guidelines, consult the MSDS.
- Check regularly for chemical leaks or spills. If a leak or spill should occur, follow the manufacturer’s cleanup procedures as recommended in the MSDS.
- Comply with all local, state/provincial, or national laws and regulations for chemical storage, handling, and disposal.

## 1.4 Chemical Waste Safety

### 1.4.1 Chemical Waste Hazard

**HAZARDOUS WASTE.** Refer to Material Safety Data Sheets and local regulations for handling and disposal.

## 1.5 Electrical Safety

**ELECTRICAL SHOCK HAZARD.** Severe electrical shock can result from operating the **TurboQ** without its instrument panels in place. Do not remove the instrument panels. High-voltage contacts are exposed when the instrument panels are not in place.

### 1.5.1 Fuses

**FIRE HAZARD.** Improper fuses or a high-voltage can damage the instrument wiring system and even cause a fire. Before turning on the instrument, verify that the fuses are properly installed and that the instrument voltage matches the mains power supply in your laboratory.

**FIRE HAZARD.** The use of fuses of the wrong type or rating presents a risk of fire. Replace fuses only with those of the type and rating specified for the instrument.

### 1.5.2 Power

**ELECTRICAL HAZARD.** Grounding circuit continuity is vital for the safe operation of equipment. Never operate a device that is not properly grounded. Use a correctly configured and approved line cord suitable for the mains voltage supply in your facility. Plug the system into a properly grounded receptacle with adequate current capacity.

## 2. General Description

The **TurboQ** Real-Time PCR System is a gene quantification and genotyping platform with a 96-well block format. **TurboQ** system software is applicable to absolute quantification, relative quantification, melt curve analysis, high resolution melt curve, and allelic discrimination.

### 2.1 Features

- Four-channel optics enable multiplex detection of up to 4 targets per well.
- The CCD based detection system is fast and results are uniform.
- The motorized sample plate transportation system is convenient and easy to use.
- Design is robust and modern.
- Adjustable and excellent ramping rate.
- The system software is user friendly and straight-forward.
- The complete analysis functions include absolute quantification, relative quantification, allelic discrimination, melting curve analysis, and high-resolution melt curve.

DOMINIQUE DUTSCHER SAS

## 2.2 Product Overview

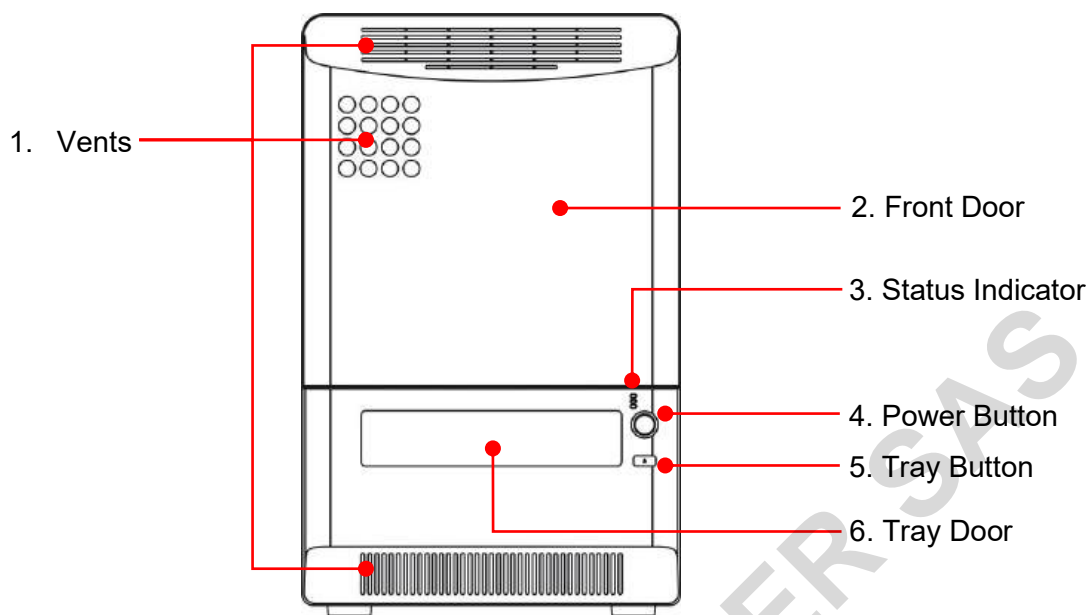

Figure 1. Front view

Table 1. Detailed description -- front view

Item	Description
1. Vents	Cooling air intake
2. Front Door	For lamp replacement (service only)
3. Status Indicator	Indicates the status of the instrument: <ul style="list-style-type: none"> <li>➤ Yellow: Warming (flashes during power-on self-test)</li> <li>➤ Green: Ready/In use (turns on after self-test / flashes while running)</li> <li>➤ Red: Error (flashes when error has occurred)</li> </ul>
4. Power Button	Power On/Off button
5. Tray Button	Tray In/Out button
6. Tray Door	Sample plate tray door

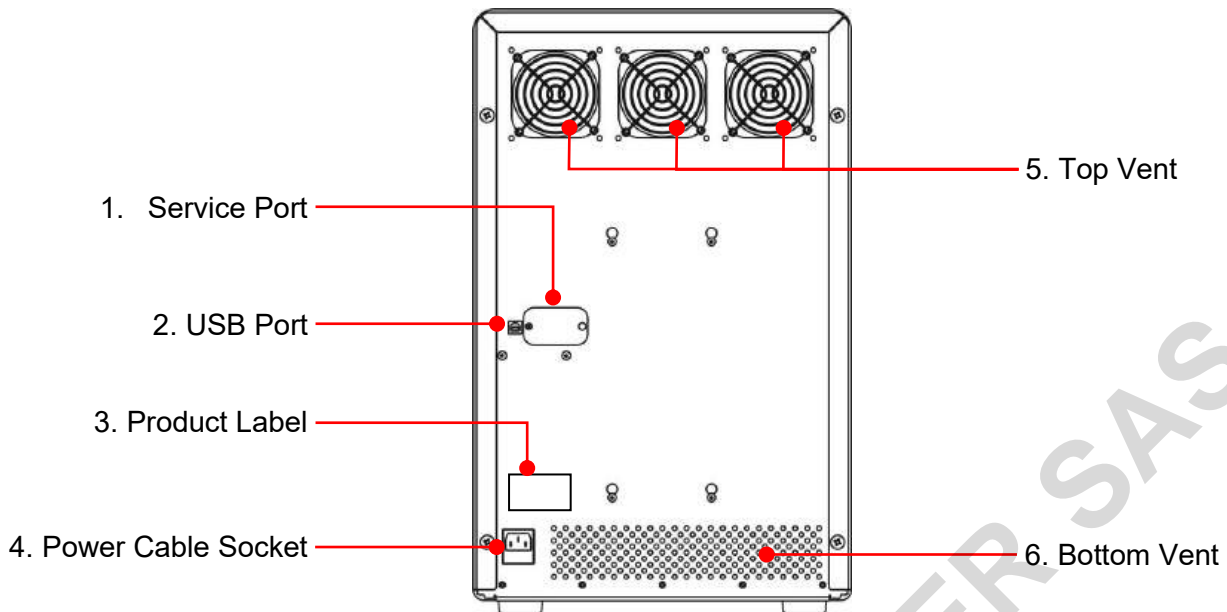

Figure 2. Rear view

Table 2. Detailed description -- rear view

Item	Description
1. Service Port	Reserved for service
2. USB Port	For connection to PC
3. Product Label	Model name, serial number, power specification, and other important information.
4. Power Cable Socket	Power cable socket and fuse compartment.
5. Top Vent	Air outlet.
6. Bottom Vent	Air intake.

## 3. Getting Started

### 3.1 Unpacking

Open the **TurboQ** package and confirm that all the items below are included.

- **TurboQ** instrument (1 unit)
- Operation manual (x1 pc)
- Plate carrier (x1 pc)
- Tungsten-halogen lamp, 75W/12V (spare part, x1 pc)
- USB cable (x1 pc)
- Power cord (x1 pc)
- **TurboQ** application USB flash drive (x1 pc)
- Fuse 5TT10, 10A/125V (spare part, x1 pc)

If there are any items missing, damaged, or any incorrect items in the package, please contact your distributor or sales representative immediately.

### 3.2 Environmental Requirements

When setting up your **TurboQ** Real-Time PCR System, avoid a dusty location, and locations with vibrations, strong magnetic fields, direct sunlight, high humidity, or large temperature fluctuations. Please refer to table 3 below for the clearance and weight tolerance required for **TurboQ** installation. Please ensure that there is enough space for the control laptop PC.

**Table 3. Clearance and weight tolerance**

Description	Specification	Clearance and tolerance
Width	354 mm	600 mm
Depth	455 mm	600 mm
Height	567 mm	800 mm
Weight	35 kg	40 kg

Instrument performance will be optimal and highly reliable within the environmental ranges shown in Table 4. However, avoiding the extremes will ensure long-term performance and life span.

**Table 4. Operating and storage conditions**

Environmental condition	Operation	Storage
Ambient temperature	+15 ~ +30°C	-10 ~ +60°C
Ambient relative humidity	below 85%	below 85%

### 3.3 Electric Power Requirements

110/230V, 50/60Hz, 1500W

### 3.4 Power On/Off

When the **Power On/Off** button on the **TurboQ** is pressed, the blue LED indicator on the power button will light up and the three status indicators will flash once. The **TurboQ** will then start a power on self-test. During the self-test, the yellow warm up LED indicator will flash continuously. The self-test takes 30 seconds after which there will be two beeps, the yellow warm up LED indicator will go off and the green ready/in use indicator will light up.

To power off the **TurboQ** system, press and hold the **Power On/Off** button for 3 seconds.

### 3.5 Front Door (for Service Engineer Only)

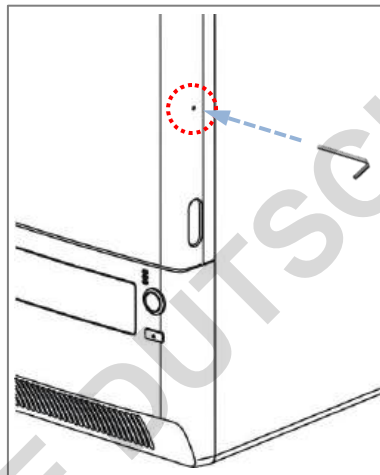

Figure 3. Front door unlock hole

To unlock and open the front door, insert a 2 mm Allen wrench, small screw driver or other similar tool into the small hole on the right side of the front door and push it in until the latch releases and the door pops open. Remove the tool.

Close the door by pushing it until the latch locks.

### 3.6 Tray In/Out

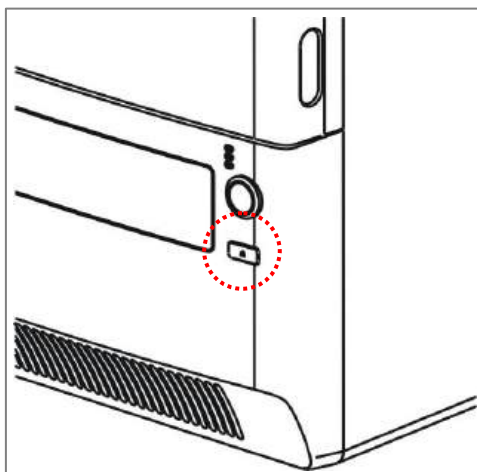

Figure 4. Tray in/out button

Press the **Tray In/Out** button (Figure 4) to eject and retrieve the plate carrier tray. Please note: the tray can only be ejected when the system is in ready or paused status. You can also eject the tray from the connected PC using the **TurboQ** software.

### 3.7 Loading the Reaction Vessel

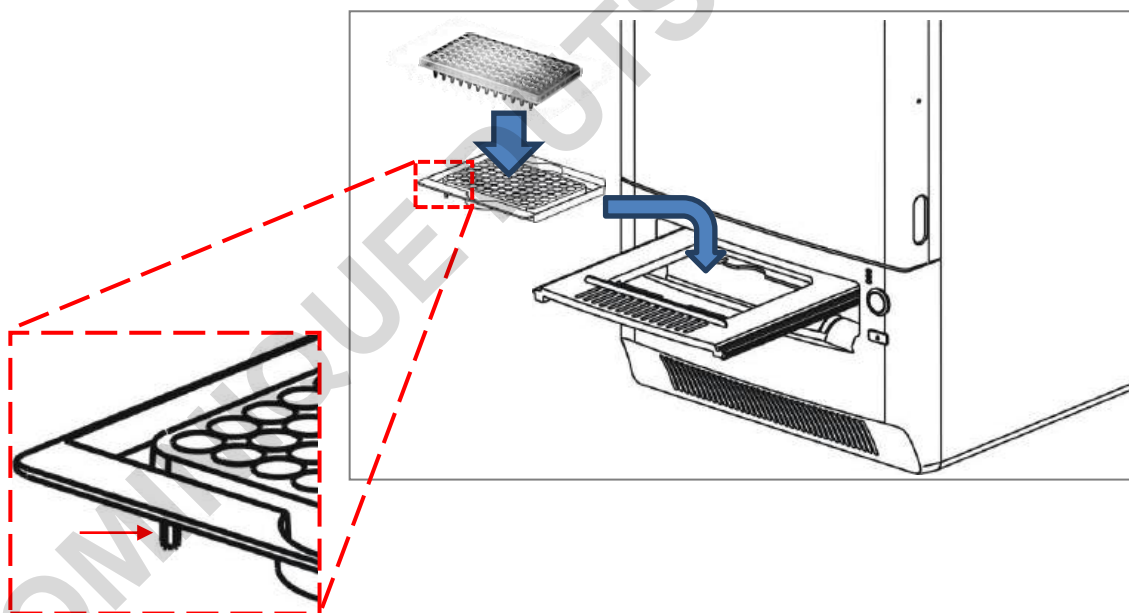

Figure 5. Alignment key on the plate carrier

The **TurboQ** system is compatible with 100/200  $\mu$ l regular profile skirted or non-skirted PCR plates. The plate, on a plate carrier, is placed on the plate carrier tray. Note: there are two alignment keys underneath the plate carrier. Make sure that the keys are on the left, upper and lower corners, when placing the plate carrier on the tray, see Figure 5.

## 4. User Interface

### 4.1 Starting the TurboQ Program

Launching **TurboQ** from the Start menu:

Start > All Programs > **TurboQ** Folder > **TurboQ** software, or double-click the desktop icon .

The **TurboQ** program can be run in the laptop PC with limited function without connection to the device. To enable all functions and perform analyses, connect the PC to the device with a USB cable.

### 4.2 Navigating the Program

Launching **TurboQ** opens the main application window in **Home** view.

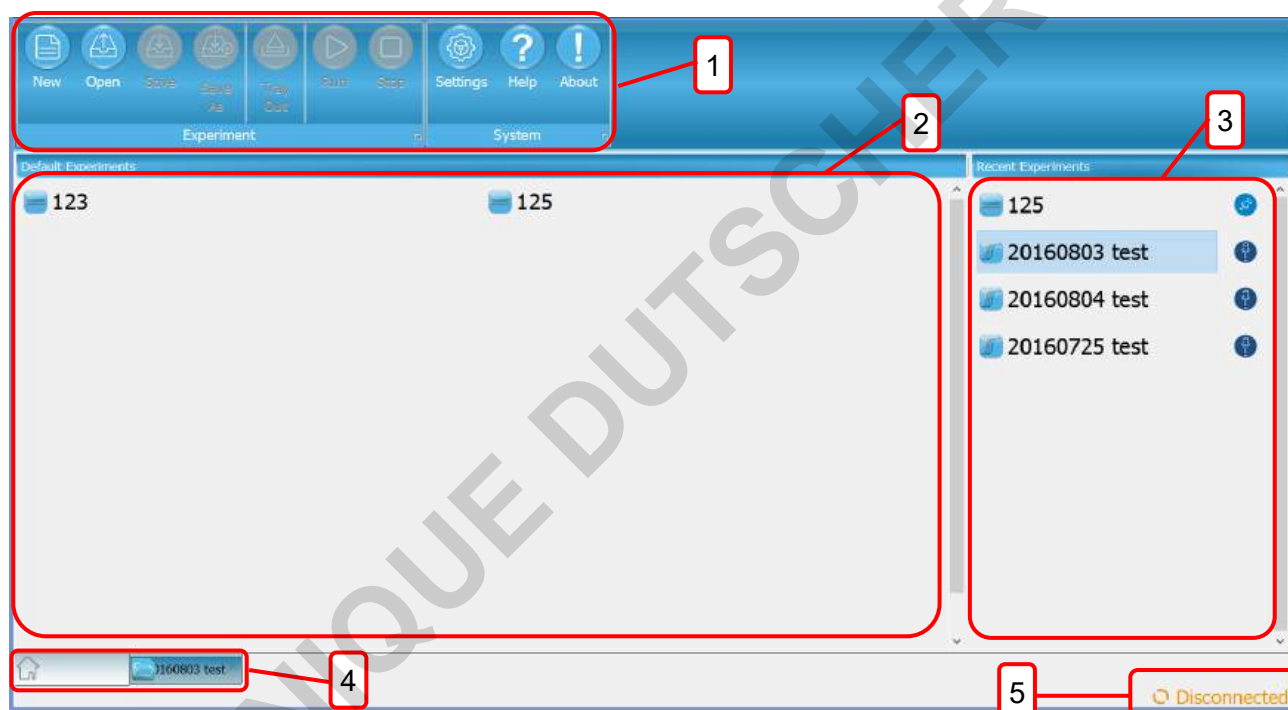

Figure 6. Main application window

The main application window contains the following elements:

- 1. Action panel**

The specific function buttons.

- 2. Default folder**

Displays the experiments template in the default folder. Double click to open an experiment template.

- 3. Recent experiments**

The user defined list of recently used experiments. Double-click a name to load and

activate an experimental record in experiment to load it and make it active. To keep an experiment on the list, click the pin icon to the right of the name.

#### 4. Navigation bar

Tabs for selecting the view. Only the currently selectable tabs are shown.

#### 5. Instrument status

Display the connection status of the **TurboQ** instrument.

When the **TurboQ** program starts up only the **Home** view is displayed. After you create a new experiment or re-open an existing experiment, the specific **Experiment** views are available. The window contents depend on the selected view. Buttons and controls are active only when they can be used.

### 4.3 View Selection

To view and active an opened experiment, select the desired experiment tab with the navigation bars at the bottom of the main window.

### 4.4 Home View











The **Home** view opens when you launch **TurboQ** software. In the **Home** view, you can create new experiments, open existing experiments, and save newly created and modified experiments.

When you open **TurboQ** software without active experiments, only the **Home** view is available with the **Experiment and System** action panels.



Figure 7. Experiment and system action panels







Table 5. Home view action buttons

Icon	Function	Description
	New	Create a new experiment.
	Open	Open an existing experiment.
	Save	Save the current experiment.
	Save as	Save the current experiment with a new name.
	Tray In/Out	Move the plate holder tray in/out.
	Run/Resume/Pause	Start, Resume or Pause the current experiment.
	Stop	Stop the running experiment.
	Setting	Open <b>TurboQ</b> Software settings.
	Help	Open <b>TurboQ</b> Software help.
	About	Display <b>TurboQ</b> software information.

## 4.5 Instrument Status

Each icon indicates the current instrument status. See the following table for the detail.

Table 6. Instrument status

Icon	Status	Description
	Connected	The <b>TurboQ</b> instrument is connected and ready
	Disconnected	The <b>TurboQ</b> instrument is not connected
	Running	The experiment is running
	Paused	The running experiment is paused
	Tray in	The tray is retracting
	Tray out	The tray is ejecting
	Error: XXX	Error(s) detected

## 5. Protocols

A protocol is a sequence of thermal cycling and data collection instructions given to a connected instrument. In the **Protocol** view, you can create and edit the protocol of the current experiment.

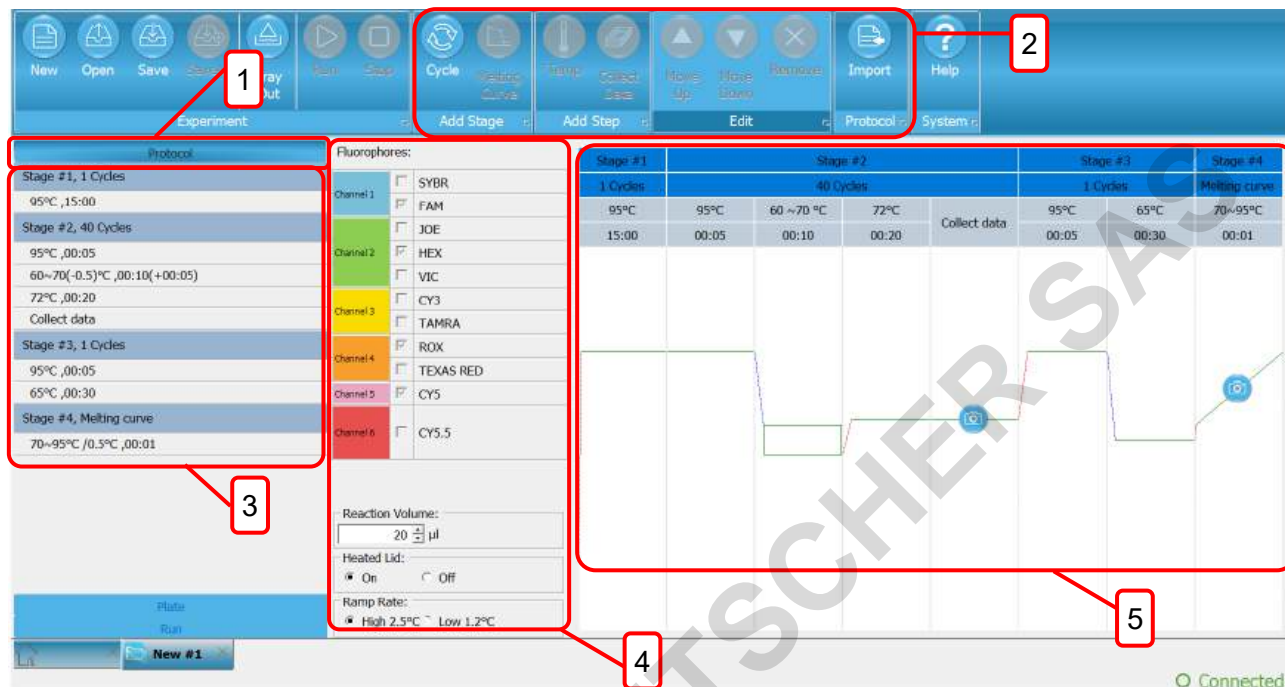

Figure 8. Protocol view

The Protocol view contains the following main fields:

1. **Protocol view**  
Display protocol editing view.
2. **Action panel**  
Action buttons for adding, removing, and reordering steps, importing protocols, and running the experiment.
3. **Protocol steps**  
Step sequence tree is for viewing and selecting steps to edit. Click a step to view and edit its properties.
4. **Step properties**  
Properties of the selected protocol step.
5. **Protocol graph**  
Protocol temperature profile shows relative temperature of each step and time for data collection.

## 5.1 Creating a New Protocol







You can create a new protocol by editing the default protocol template or the protocol of an existing experiment. To open an existing protocol for editing, import a protocol by clicking the **Import** button in the **Protocol** view (Figure 9.).



Figure 9. Import button

Edit the protocol by selecting a protocol step and then using the buttons in the **Add Stages**, **Add Steps** and **Edit** action panels.

Table 7. Protocol editing commands

Icon	Function	Description
	Cycle	Add a cycle stage, which can include temperature and data collection steps. Select the cycle stage and click the <b>Temp</b> or <b>Collect Data</b> button to add them to the cycle.
	Melting Curve	Add a melting curve stage, which you can set the start and end temperatures, and advanced properties.
	Temperature	Add a temperature step, which you can define the temperature and time, as well as hold and define advanced properties.
	Collect Data	Add a data collection step to a stage.
	Move Up/Down	Move the selected stage/step upwards or downwards within the protocol.
	Remove	Remove the selected stage/step from the protocol.

Click the **Cycle** or **Melt Curve** button to add the corresponding stage to the protocol. The new stage is added below the selected stage.

Click the **Temp**, **Collect Data** button to add the temperature step or data collection to the stage. The new step is added below the selected step in the stage. If you select the stage header, the new step is added as the first step. The melting curve step contains data collection by default.

The protocol is executed as a sequence from top to bottom, that is, the first step is at the top and the last is at the bottom. You can change the execution order of the stages/steps in a protocol by selecting a stage/step and clicking the **Move Up** or **Move Down** buttons.

**Delete** stages/steps from the protocol by highlighting them and clicking the **Remove** button.

## 5.2 Protocol Properties

Select the **Protocol** header in the protocol sequence to view the **Protocol Properties** (Figure 10.) and define the **Fluorophores** and **Reaction Volume** used.

Channel	Fluorophore	Selected
Channel 1	SYBR	<input type="checkbox"/>
	FAM	<input checked="" type="checkbox"/>
Channel 2	JOE	<input type="checkbox"/>
	HEX	<input type="checkbox"/>
	VIC	<input type="checkbox"/>
Channel 3	CY3	<input checked="" type="checkbox"/>
	TAMRA	<input type="checkbox"/>
	ROX	<input checked="" type="checkbox"/>
Channel 4		

Reaction Volume: 20 µl

Heated Lid:  On  Off

Ramp Rate:  High  Low

Figure 10. Protocol properties

### 5.2.1 Fluorophores

All fluorophores are selected by default in a new experiment. Click a fluorophore to disable or enable it. You can define the colors used to designate the fluorophores in **Settings > Fluorophores**.

We recommend that you select only the fluorophores that are required for the experiment.

#### Note

Only the selected fluorophores and corresponding channels are measured and available in the layout. Unmeasured channels cannot be added after an experiment has been run.

### 5.2.2 Reaction volume

Enter the reaction volume, the range of which is 10–100 µl. After entering the volume, please press **Enter** to confirm the input.

### 5.2.3 Heated Lid

Select **On** to enable or **Off** to disable the lid heater.

### 5.2.4 Ramp Rate

Set the default block heating/cooling rate for the protocol. Individual ramp rate settings override this default setting. See “**Temperature Step**” on page 18.

## 5.3 Cycle Stage

Add a cycle stage to a protocol by clicking the **Cycle** button. The new stage window pops up (Figure 11.). Select the numbers of temperature steps you want to include in this new stage and the cycle numbers for the stage. You can key-in the number directly and press **Enter** to confirm the input. Set the temperature and the time for each step and click **OK**. The new stage is added below the currently selected stage. If the protocol header is selected, the new stage is added as the first stage in the protocol.

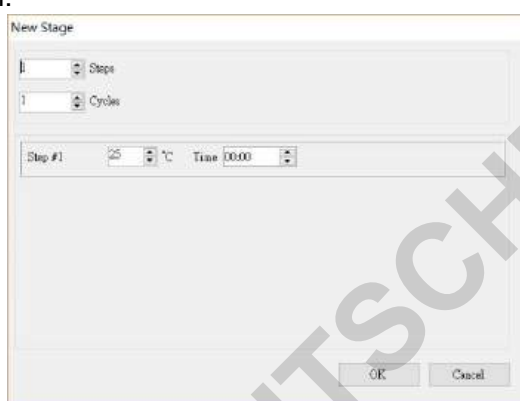

Figure 11. Cycle stage setting

A cycle stage can contain one or several temperature steps with or without data acquisition.

Extra temperature or collect data steps can be added to a cycle stage afterwards. You can also re-arrange the order of the stage by selecting it and clicking the move up or move down icon. When you move a cycle stage, all its contents move with it.

Use the **Cycle Number** to set the number of cycles in the selected step (Figure 12.).

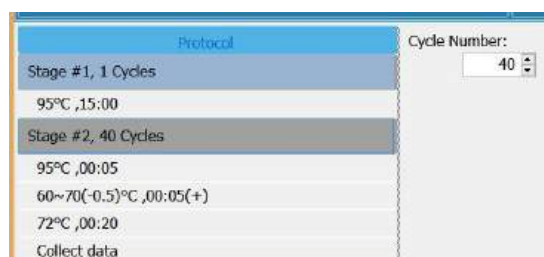

Figure 12. Cycle number

### 5.3.1 Temperature step

Add a temperature step to a stage by clicking the **Temperature** button. The new temperature step is added below the currently selected step. If the stage header is selected, the new step is added as the first step in the stage.

After adding a temperature step,

The dialog box is titled 'Single Temperature'. It contains three main sections:
 

- Temperature:** A numeric input field set to '95' followed by a degree Celsius symbol.
- Time:** A time input field set to '00:05'.
- Ramp Rate:** Two radio buttons, 'High' (selected) and 'Low'.

Figure 13. Temperature step

1. Define the target temperature. The temperature range is 25.0–99.0°C.
2. Set the step duration using the **Time** control. The duration range is 00:00–59:59 (mm:ss)
3. You can also specify the **Ramp Rate** for the specific step.

In addition to the basic settings, you can configure the following temperature step properties by selecting the **Gradient Temperature** (Figure 14.).

The dialog box is titled 'Gradient Temperature'. It contains several sections:
 

- Gradient:** Two numeric input fields, '60' and '70', followed by a degree Celsius symbol.
- Time:** A time input field set to '00:10'.
- Temp. Change Per Cycle:** A checked checkbox, a 'Decrease' checkbox (checked), and a numeric input field set to '0.5'.
- Time Change Per Cycle:** A checked checkbox, a 'Decrease' checkbox (unchecked), and a time input field set to '00:05'.
- Table:** A table with 12 columns and 2 rows. The first row is labeled 'Column' and contains numbers 1 through 12. The second row contains temperature values: 60, 60.5, 60.9, 62.1, 63.5, 64.9, 65.6, 66.6, 67.9, 68.9, 69.5, 70.
- Ramp Rate:** Two radio buttons, 'High' (selected) and 'Low'.

Figure 14. Gradient temperature

Gradient allows you to set the gradient temperature range for the step. An estimated temperature range for each column is displayed.

**Temperature Change Per Cycle** allows you to define a fixed temperature increment per cycle until a temperature range limit is reached for a temperature step within a cycle stage. If you want the step temperature to decrease per cycle, check the **Decrease** box.

**Time Change Per Cycle** allows you to define a fixed time increment per cycle until a time range limit is reached for a time step within a cycle stage. To decrease time, check the **Decrease** box.

### 5.3.2 Data collection step

**Collect Data** step can be added after an individual or cycled temperature step. A melting curve step contains data collection by default.

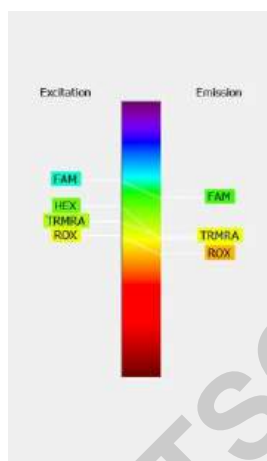

Figure 15. Fluorophore mapping

Select the **Collect Data** step to view its properties, which present the channel and fluorophore mapping (Figure 15.) and the channels that have been selected for measurement.

### 5.3.3 Channel wavelengths

The detection channel wavelength ranges of the **TurboQ** system are presented in table 8.

Table 8. Detection channel wavelength ranges

Channel	Excitation wavelengths	Emission wavelengths	Fluorophore
1	450-490nm	505-535nm	FAM, SYBR Green
2	510-530nm	545-570nm	HEX, VIC, JOE
4	565-595nm	610-645nm	ROX, Texas Red
5	625-645nm	660-685nm	Cy5

## 5.4 Melt Curve Stage

A melting curve stage is included in any new protocol by default. If you don't want to include the melting curve stage, you can delete it. Add a melt curve stage to a protocol by clicking the **Melt Curve** button. The new melt curve stage is added under the currently selected stage.

**Note**

Only one melt curve stage can be present in a protocol.

Start Temperature: 70 °C  
Stop Temperature: 95 °C  
ΔT: 0.5 °C  
Hold Time: 00:01

Figure 16. Melt curve stage

Use the **Start Temperature** and **Stop Temperature** controls to set the beginning and end temperatures of the melt.  $\Delta T$  defines the increase in temperature between steps, and can be set to between 0.1–10°C. If you want to have HRM analysis, **please set  $\Delta T < 0.2^\circ\text{C}$** .

Hold Time defines the duration of one step, and can be set to between 00:00 and 59:59 (mm:ss).

**Note**

The minimum actual hold time depends on the number of channels measured and may be as high as 13 seconds even when the **Hold Time** setting is set to 00:00.

## 5.5 Importing Protocols

You can import protocols from existing experiments. This allows you to handle protocols separately from experiments.

To import a protocol file, click the **Import** button in the **Protocol** action panel of the **Protocol** view. Browse to the file and click **Open**.

## 6. Plate Layout

Plate layout refers to the location of samples in the plate wells. The layout contains, for each plate well, information on the fluorophore, target, sample type, and quantity of a standard as well as descriptive information.

You can create and edit the layout in the **Plate Layout** view (Figure 17.).

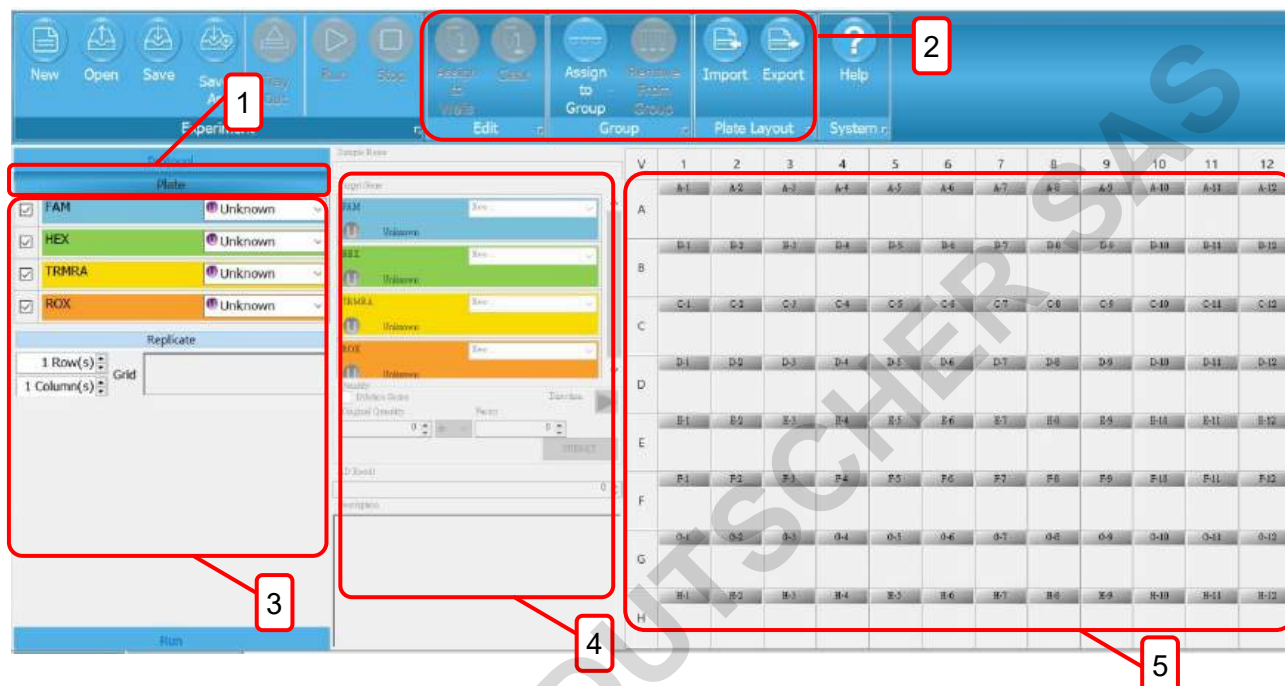

Figure 17. Plate layout

The **Plate Layout** view contains the following fields:







1. **Plate view**  
Display the plate layout setting view.
2. **Action panel**  
Action buttons for entering well content and sample properties, creating replicates and sample groups, importing, and exporting layout files.
3. **Editing panel**  
This panel is used to select well contents and replicate data.
4. **Property panel**  
This panel is used to edit sample properties and fill quantity series.
5. **Plate layout**  
Graphical representation of the contents of each well.

The layout can be empty when running a protocol. An edited layout can also be modified during or after protocol execution.

## 6.1 Creating a Layout

You can create a new plate layout from a blank template or by editing an existing layout. To edit an existing plate layout, import the layout from a protocol file using the **Import** button in the **Plate Layout** action panel.

**Table 9. Layout editing commands**

Icon	Function	Description
	Assign to Well	Assign the selected setting to well(s).
	Clear	Clear the setting from well(s).
	Assign to Group	Assign well(s) to a group.
	Remove from Group	Remove well(s) from a group.
	Import Layout	Import saved layout.
	Export Layout	Export layout to a csv. file or a template.

To create a plate layout:

1. Select the appropriate fluorophores from the **Fluorophore** list in the **Editing** panel by clicking them.

Note
The <b>Fluorophore</b> list contains only those fluorophores that have been selected in <b>Protocol Properties</b> in the <b>Protocol</b> view.
Remove fluorophores by un-checking them from the <b>Fluorophore</b> list.

2. Define the sample type for each fluorophore by selecting the appropriate sample type in the **Sample Type** drop down list. See "**Sample Type**" on page 23.
3. If required, define the replicate layout by entering the number of columns and rows.
4. Select well or wells on the graphical plate layout. The selected wells are filled. You can select a row or a column by clicking the appropriate heading and the entire plate by clicking the button in the top left-hand corner of the plate. If you have entered a grid pattern into the **Replicates** panel, mimic that pattern when painting the target wells. You can generate several replicate sets by painting over multiples of the replicate grid area.







Once you have filled the desired wells, click the **Assign to Wells** icon in the **Plate Layout** action panel.

5. Select the appropriate wells in the layout and enter their properties in the **Property** panel. You can enter the sample name and choose the target. With **Standards**, you can enter the quantity, and with **AD Standards**, you can enter the standard value. If necessary, add targets in the **Target Gene** field by selecting **New** in the target gene name drop down list, entering the designation and pressing **Enter**. Within one well you can associate one target per fluorophore. Remove a target by selecting it in the target gene name drop down list and clicking the **X** icon.
6. Add any relevant descriptive sample information in the **Description** field. Repeat these steps to enter the layout data.

## 6.2 Sample Type

The sample types are designated by a color code and an abbreviation in a circle. The following sample types are available:

**Table 10. Sample types**

Icon	Sample type	Description
	Unknown	Unknown sample.
	Standard	Sample with known concentrations.
	NTC	No Template Control. A control sample.
	Positive	Positive amplification control.
	Negative	Negative target control.
	Reference	Endogenous reference gene or housekeeping gene.
	AD	Allelic discrimination standard

The sample type icon is displayed on top of the fluorophore bar in the layout wells.

If you select **Standard** as the sample type, enter the standard value in the **Property Panel**. You can create a standard series by checking the **Dilution Series** box.

If you selected **AD Standard** as the sample type, enter the **AD result** in the **Property Panel**.

## 6.3 Dilution Series

Select the filling direction, the initial quantity, the mathematical operator for creating the series and the factor, then click on the **Submit** icon

## 6.4 Grouping Samples

You can combine several wells into sample groups if necessary. Each sample group has individual analysis options. Individual sample groups are added to the **Analysis tree** as separate items.

The created sample groups are analyzed independently from each other even when sample groups overlap.

To group samples:

1. Select the appropriate wells in the plate layout.
2. Click the **Assign to Group** button in the **Group** action panel and select the group name from the list, or select **New...** and enter the group name. Click **Ok** after you have entered the group names, then select the new group.

You can remove wells from a group by selecting the wells and clicking the **Remove from Group** button.

You can edit sample group names and delete sample groups in the **Assign to Group** drop down list.

## 6.5 Importing and Exporting Layouts

You can import and export plate layouts as separate files with the .csv file extension. This allows you to handle layouts separately from experiments. **Note that you cannot import layouts directly from an experiment.**

To import a plate layout, click the **Import** button in the **Plate Layout** action panel of the **Plate Layout** view. Browse to the file and click **Open**.

To export a plate layout, click the **Export** button in the **Plate Layout** action panel of the **Plate Layout** view. Browse to the desired file location, name the file, and click **Save**.

## 7. Executing an Experiment

An experiment can be executed if you have a defined protocol with the appropriate steps. A protocol can be run with an empty plate layout.

The following procedure assumes that you have a **TurboQ** instrument already powered up and connected.

To execute an experiment:

1. Open the **TurboQ** tray and insert the reaction vessels.
2. Close the tray and click the **Run** button to initialize protocol execution.
3. If you have not saved the experiment, enter a name for the experiment file to be created and click **Save**.

When protocol execution is started, the **Run** view opens.

### 7.1 Executing an Existing Experiment

You can rerun a previously generated experiment file, for example, with a layout composed of a different set of samples.

To rerun a previously generated experiment file, create a new experiment and import the protocol. You can create a new plate layout or import a plate layout from an existing experiment file. After editing, you can execute the experiment.

## 8. Monitoring a Run

The execution of an experiment can be monitored in the **Run** view. This view is active only when an experiment is being executed.

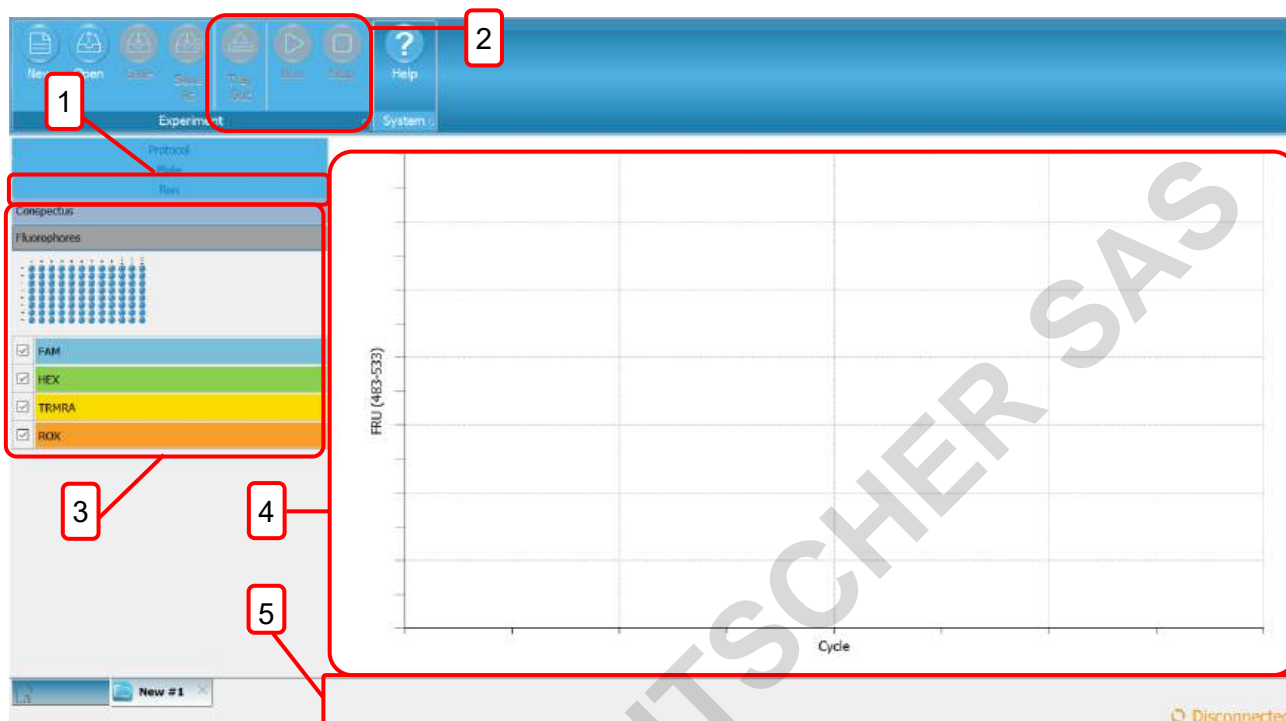

Figure 18. Current status

The **Current Status** view contains the following main fields:

1. **Run view**  
Display the running status view.
2. **Action panel**  
Action buttons for controlling the instrument drawer, pausing, resuming, and stopping the experiment.
3. **Display option**  
Allows you to select the information you want to monitor. You can toggle between the current protocol step or the sample's fluorescence intensity. You can also select to monitor specific wells or fluorescence channels.
4. **Display area**  
The selected information will be displayed here. They will be updated each cycle.
5. **Status**  
Shows the remaining run time, current cycle number, and a visual and numerical indication of the instrument temperature.

## 8.1 Adding Reagents During a Run

You can add reagents to a protocol under execution. The **TurboQ** instrument will maintain the block temperature specified in the current step when the protocol is paused for adding reagents.

To add reagents:

1. Click the **Pause** button on the action panel to temporarily halt protocol execution.
2. Open the instrument tray and add the reagent.
3. Close the instrument tray.
4. Click the **Resume** button on the action panel to resume protocol execution.

DOMINIQUE DUTSCHER SAS

## 9. Analysis

After the execution of the experiment and the data collected, the **Run** view will be replaced and the **Analysis** view is available. The **Analysis** view is used to perform various analyses on the fluorescence data.

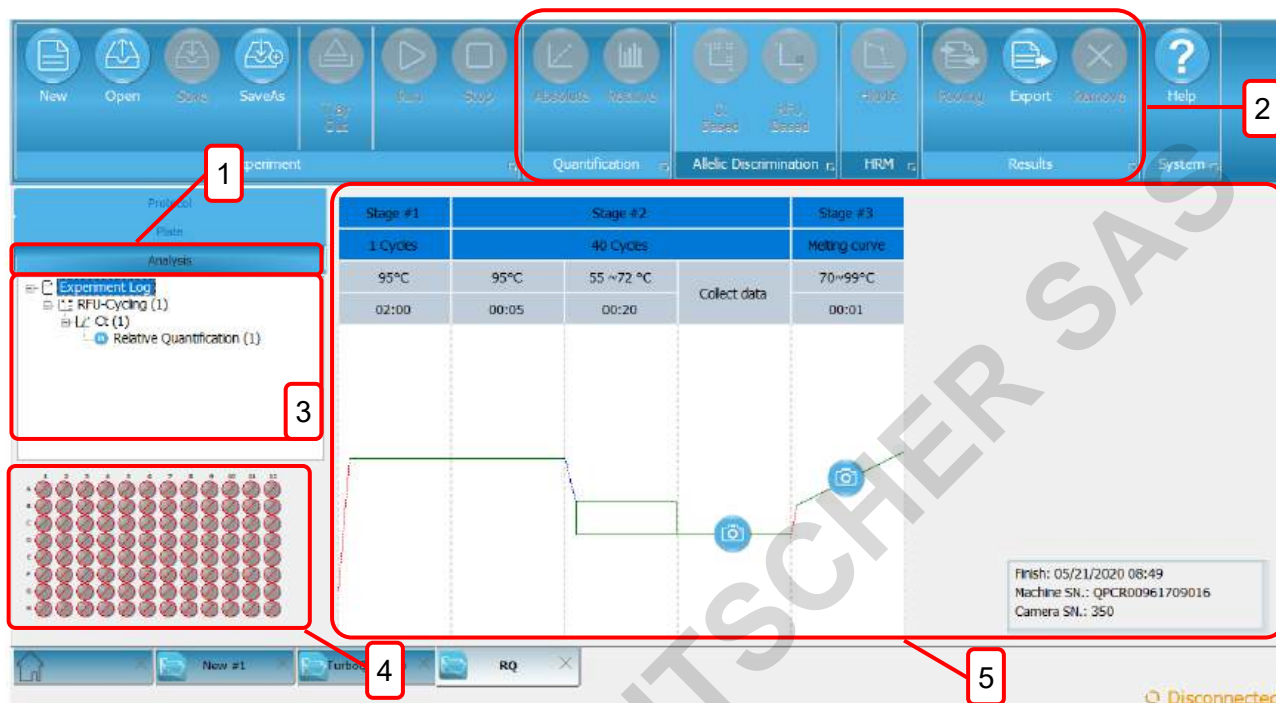

Figure 19. Analysis view

The **Analysis** view contains the following main fields:

1. **Analysis view**  
Display the data analysis view.
2. **Action panel**  
Analysis view action buttons for adding and removing analyses and exporting data.
3. **Analysis tree**  
A hierarchical description of the selected analyses.
4. **Well selector**  
Well selector for selecting individual wells, well groups or the entire plate for result viewing. The well selector does not affect the analyses.
5. **Analysis data**  
The data and settings of the selected analysis.

### 9.1 Run Log

When first opened, the **Analysis** view shows the run log for the experiment. This log view presents instrument details and any errors that have occurred during protocol execution.







You can access this view by selecting the **Analysis** item in the **Analysis tree**.

## 9.2 Adding Analyses

Depending on the protocol, you can add some or all of the following analyses:

- Absolute Quantification
- Relative Quantification
- Allelic Discrimination
- Melting Curve Analysis
- HRM

**Table 11. Analysis icon**

Icon	Function	Description
	Absolute Quantification	Execute absolute quantification analysis.
	Relative Quantification	Execute relative quantification analysis.
	Allelic Discrimination	Execute Ct or RFU based allelic discrimination.
	HRM Analysis	Execute high resolution melt curve analysis.
	Pooling	Import other plate(s) to execute relative quantification.
	Export	Export graph or table.
	Remove	Remove current analysis.

The analysis tree contains one **RFU-Cycling** item for each data collection step in the protocol and a **Melt Curve Data** item, if the protocol includes a melting step. The **RFU-Cycling** items are numbered consecutively.

By default, each **RFU-Cycling** item includes a **Ct** (cycle of threshold) item and an **RFU-Melting** item includes a **Melting Curve** item. New analyses are added below a **Ct** in each data collection step.

To add a new analysis:

1. Select the appropriate **Ct** item in the analysis tree.
2. Click the desired analysis button in the action panel. Only the currently selectable analyses are available. Select the added analysis item to view its data and settings.

### Note

Some analysis items share settings, for example, absolute quantification shares all its settings with its parent **Ct** item.

### 9.3 Analyzing Sample Groups

If you wish to limit an analysis to a group of samples, you need to create a new **Ct** or **Melt Curve Data** item with a sample group under which you can add the desired analyses. Sample groups are defined in the **Plate Layout** view, see “**Grouping Samples**” on page 20.

### 9.4 Exporting Analyses

**TurboQ** software allows you to export analysis data as a .csv.

Note
The exported data is from the sample group currently selected in the <b>Analysis Tree</b> . To export data, click the <b>Export</b> button in the <b>Results</b> action panel of the <b>Analysis</b> view. Browse to the desired file location, name the file, and click the <b>Save</b> button.

## 10. Ct and Absolute Quantification

The **Cycle of Threshold (Ct)** views present the measured fluorescence values, analysis settings, the RFU (Relative Fluorescence Unit) values, and results as a table.

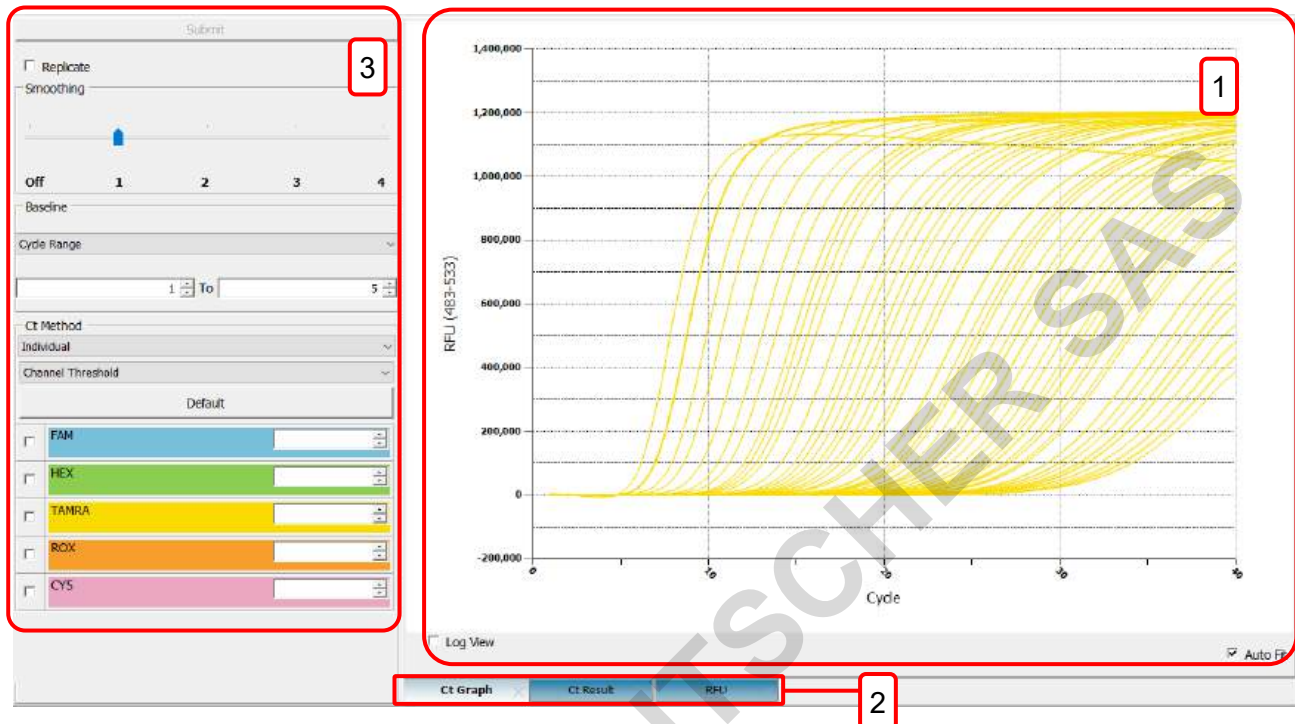

Figure 20. Ct Analysis

The Ct analysis includes:

- 1. Display area**

Display the selected data.

- 2. Results tab**

Select to display the log quantity graphs of the samples for the selected fluorophores, the Ct results or RFU values for the selected fluorophores present as a table.

- 3. Settings**

You can control the settings for Ct determination in the Settings field.

You can use the **Well Selector** to select the well data to be shown. The **Settings** field provides options for presenting data for replicates or all wells.

In addition, the **Absolute Quantification** analysis view contains the **Standard Curve Graph** (shown below).

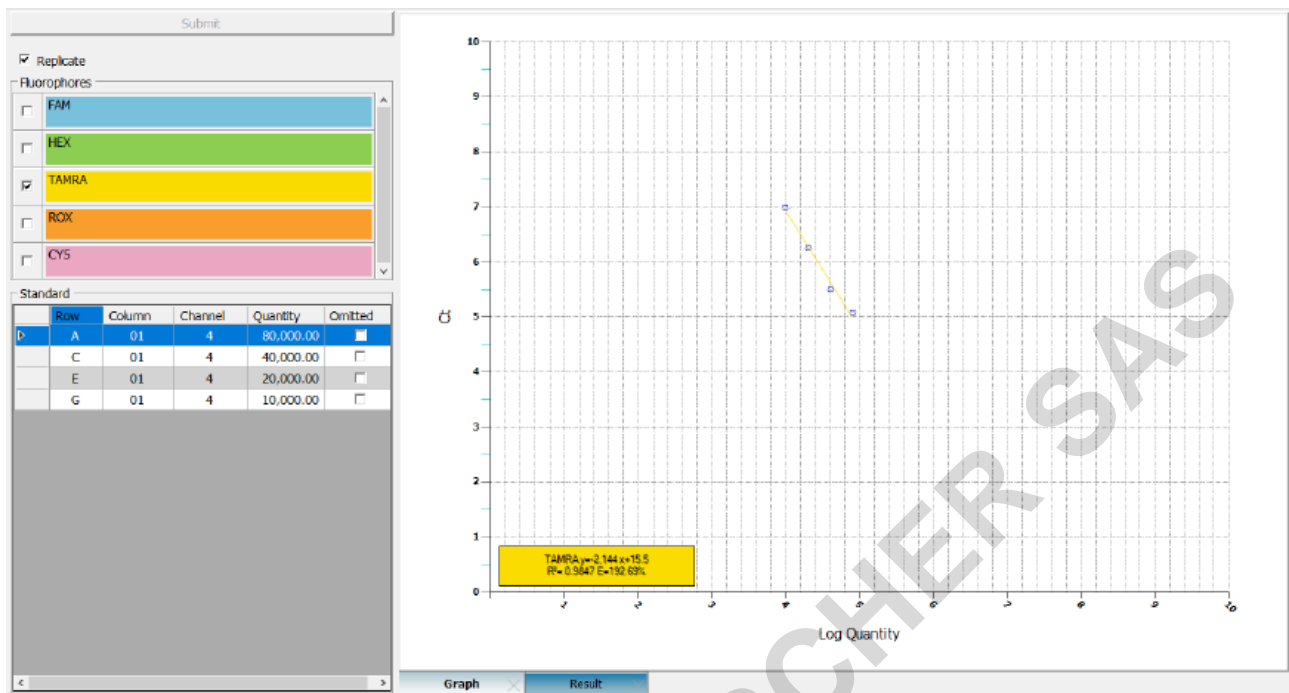

Figure 21. Absolute quantification analysis

## 10.1 Adding an Absolute Quantification Analysis

To add an absolute quantification analysis:

1. In the **Analysis** view, select the **Ct** item for which the analysis is to be performed. The **Ct** item can encompass all wells or be the **Ct** of a distinct sample group.
2. Click the **Absolute** button in the **Quantification** action panel.

The absolute quantification analysis is presented as an **Absolute Quantification** item in the **Analysis Tree**. Select the analysis item to view its data and settings.

## 10.2 Graphs

The **Ct Graph** presents the fluorescence graphs of the selected samples (for the selected fluorophores). The RFU intensity is presented on the Y axis and the cycles are presented on the X axis. Tick the **Log View** box below the RFU axis to use a logarithmic scale in the **Ct Graph**. This setting can be toggled on or off.

The **Standard Curve Graph** plots the standard sample quantities against the determined Ct values for the samples specified as standards in the plate layout. The logarithmic quantities are presented on the X axis and the Ct values on the Y axis.

The **Standard Curve Graph** also shows the standard curve equation, R2 value and the calculated reaction efficiency.

Note
When using multiple channels (multiplexing), you can have a separate standard curve for each fluorophore.

## 10.3 Settings

**Table 12. Instrument status**

Description	Function
Replicate	Untick to view the information individually or tick the box to view replicates.
Smoothing	The smoothing bar is used to eliminate the noise background. The larger the number, the more background noise can be reduced. Slide to <b>off</b> to deactivate this function.
Baseline	To view the curve with/without baseline normalization. If you would like to have normalization, please select cycle number, and input the cycle range. You can select none to see the raw data and exclude the abnormal wells.
Ct Method	To select threshold Ct or individual Ct.
Channel Selection	To select the channel(s) to view.

## 10.4 Baseline

Baseline is required to compare amplification curves with different signal levels and to determine suitable threshold values. Baseline is the basis for determining Ct.

The **Baseline** setting has the following method options:

- **None**  
No baseline is set for the curves.  
This option can be used to look at the raw data and, for example, to find and exclude abnormally behaving samples, as well as to compare reagent, primer, and probe batches.
- **Cycle Range**  
The baseline of each curve is calculated based on a trend prediction algorithm.  
The cycles used for baseline trend prediction are set manually. The baseline (and whole curve) is shifted to a horizontal line and the average of the baseline value is set to zero.

## 10.5 Threshold Ct

**Threshold** method for calculating the cycle of quantification is one of the ways to calculate Ct. The method is discussed in detail below.

In the **Threshold** method for calculating the **Cycle of Threshold**, a threshold value is set for the fluorescence values.

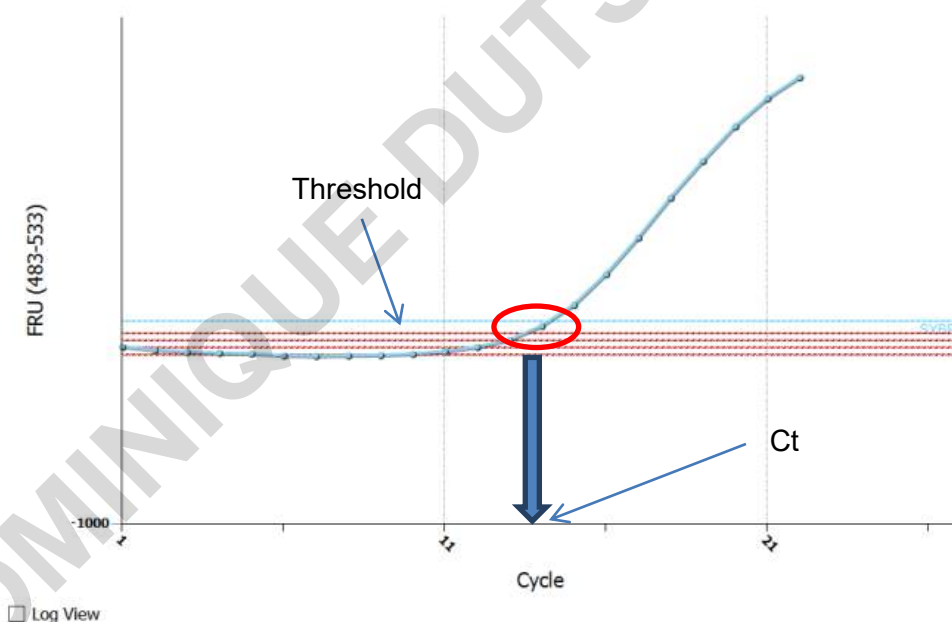

Figure 22. Ct determination

The threshold is presented as a line in the graph, the intercept point of the amplification graph and the threshold line determines the Ct value (Figure 22.). The threshold lines of different channels are presented in different colors. The threshold value can be set automatically or manually.

**Default** button uses an algorithm to calculate the default threshold value based on the baseline and signal noise.

You can also adjust the threshold manually by clicking and dragging the threshold line or by entering a numeric value in the threshold field of a fluorophore.

**Note**

Whenever you change the baseline method, click the **Default** button to recalculate the default threshold values.

## 10.6 Individual Ct

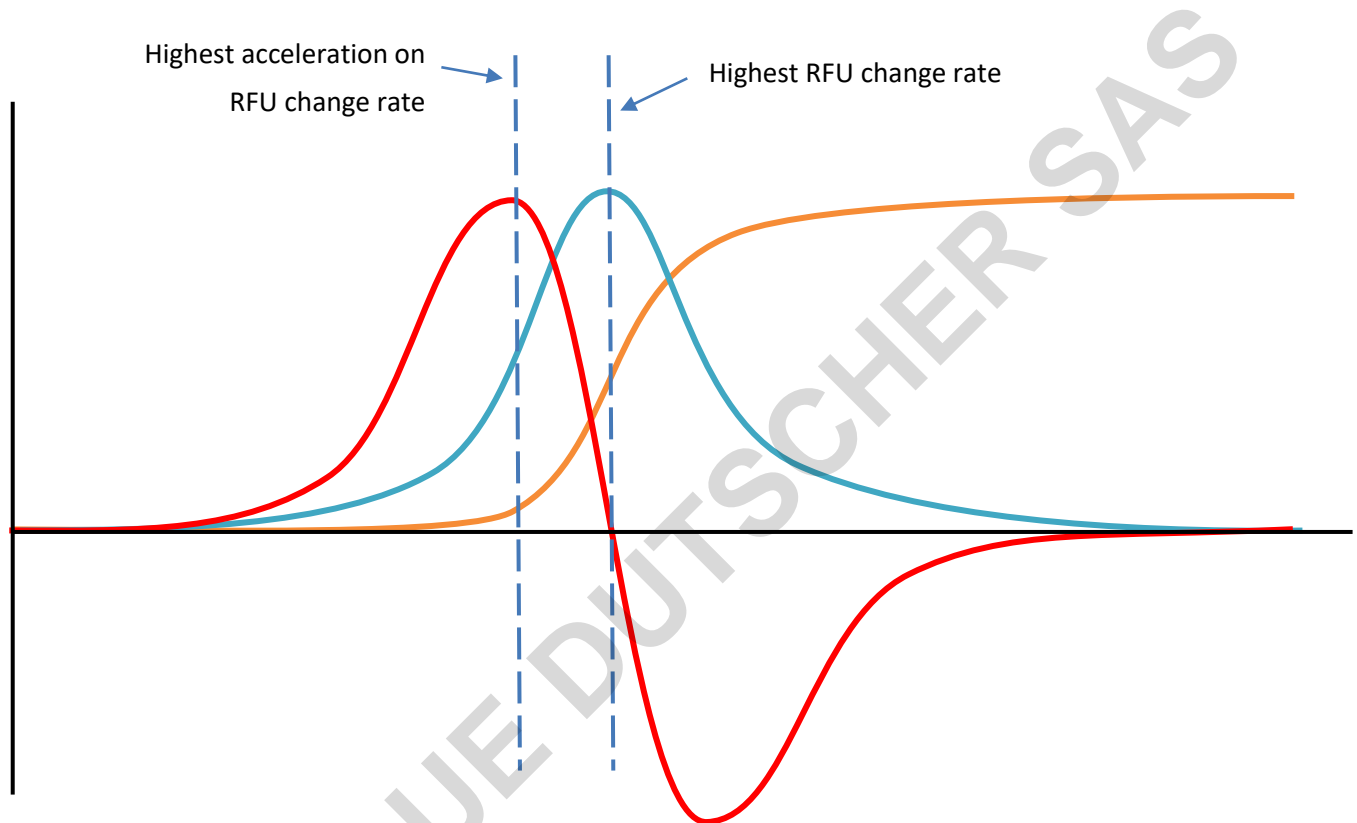

Figure 23. Individual Ct

**Individual Ct** feature looks for the timing at which there is highest acceleration on RFU change rate (Figure 23.).

In the figure above, the orange curve is the RFU over time (cycler number), representing the detected RFU signal (target nuclear acid amount) at the end of each cycle. The blue curve is the first derivative of the orange curve, representing the RFU change rate (target production rate) over time (cycle number). The peak of the blue curve is the time at which the RFU signal has highest increasing rate, meaning the highest target production rate. However, after this moment, either due to a decrease in enzyme activity or a shortage in material supply, the target production rate begins to drop. This moment is affected not only by the amount of the target DNA in the tube, but also the amount of variation in the enzyme and the dNTPs. The amount of variation in the enzyme and the dNTPs caused by pipetting error will have a huge impact at this relatively late period of the entire PCR process.

The second derivative curve (red curve) represents the acceleration/deceleration on the RFU change rate. The peak of the red curve is the timing at which there is the highest potential for speeding up the target production. At this moment, the enzyme activity is high and there is sufficient material supply in the solution. The amount of variation in the enzyme and the dNTPs caused by pipetting error will have a minor impact at this relatively early period of the PCR process. This moment is affected mainly by the amount of the target DNA in the tube, thus making this a good indicator for Ct. There is no personal adjustment factor for the individual Ct determination, thus no human variation will be introduced.

## 10.7 Results

The **Ct Result** tab shows the results of the data analysis:

- The well, fluorophore, sample type, sample name, target and description columns show the selected well positions and the sample data entered in the layout.
- The **Ct** column shows the determined **Cycle of Threshold**.

The **Result** tab for the **Absolute Quantifications** item shows the results of the absolute quantification analysis:

- The **Quantity** column shows the specified quantities of the standards and the calculated quantities for the other samples. Based on the standard curve, the system automatically calculates the quantity for each sample not specified as a standard.

**Note:**

The standard curve is created separately for each fluorophore and optionally for each sample group.

- The **Omitted** column shows the standard samples removed from the **Standard Curve Graph**.

The **RFU** tab presents the raw fluorescence data measured for each fluorophore. The data also indicates the cycle number and the temperature for each data collection step.

You can export the data from the **Results** or **RFU** tab for use in other software tools by clicking the **Export** icon in the action panel.

## 11. Relative Quantification

**Relative Quantification** is based on determining the ratio between the expression levels of a target molecule and one or more reference molecules in a sample, and to further compare these ratios between the sample and the control. The results of the relative quantification analysis are expressed as relative quantity between the samples.

In **TurboQ** software, the ratios are calculated using the  $\Delta\Delta\text{Ct}$  method, which uses the Ct values.

First, the following is calculated for each sample:

$$\text{Ct}_{\text{target}} - \text{Ct}_{\text{ref}} = \Delta\text{Ct}$$

where **target** is the target molecule, and **ref** is the reference molecule.

The subtraction of the  $\text{Ct}_{\text{ref}}$  values normalizes for the variation in the sample material.

If multiple reference genes are used,  $\text{Ct}_{\text{ref}}$  is calculated as a geometrical average of all reference genes:  $[\text{Ct}_{\text{ref1}} \times \text{Ct}_{\text{ref2}} \times \text{Ct}_{\text{ref3}} \times \dots \times \text{Ct}_{\text{refn}}]^{1/n}$ , where  $n$  = number of reference genes.

Second, one sample is designated as the control sample. This is usually the sample with the lowest expression (highest Ct).

The  $\Delta\text{Ct}$  for the control is then subtracted from the  $\Delta\text{Ct}$  of each of the other samples using the equation:

$$\Delta\text{Ct}_{\text{sample}} - \Delta\text{Ct}_{\text{control}} = \Delta\Delta\text{Ct}$$

The final calculation converts the  $\Delta\Delta\text{Ct}$  values to a factor representing the relative quantity, that is, the difference in expression of the target molecule in the sample compared to the expression in the control sample:

$$2^{-\Delta\Delta\text{Ct}} = \text{Relative Quantity}$$



Figure 24. Relative quantification

The **Relative Quantification** analysis view includes the following main fields:

### 1. Display area

Display the selected data or graph.

### 2. Results tab

The graph presents the results as relative quantities for each sample well or replicate group.

Clicking the **Result** bar for each sample well or replicate group shows the well position, fluorophore, sample name, target and result at the top of the graph.

For replicate groups, the sample name and target/reference is shown also on the result bars.

In multiplex assays, each fluorophore is shown in a distinct color.

Relative quantification results are displayed as a table for each sample well or replicate group, depending on the chosen display settings.

### 3. Settings

The **Settings** field has options for showing the replicate groups and all sample wells, as well as settings for defining the control sample and selecting the fluorophores to view.

The **Target Amplification Efficiency** allows you to adjust the reaction efficiency used in the calculations.

## 11.1 Adding a Relative Quantification Analysis

To add a relative quantification analysis:

1. In the **Plate Layout** view, make sure that the following information is entered in the layout data, or enter it at this stage:
  - a. Designate the reference genes with the **Reference Gene** sample type.
  - b. Identify the different genes in the layout using different **Targets**.
  - c. Designate the samples using distinct **Sample Names**.
2. In the **Analysis** view, select the **Ct** item for which the analysis is to be performed. The **Ct** item can encompass all wells or be the Ct of a distinct sample group.
3. Click the **Relative** button in the **Quantification** action panel.  
The relative quantification analysis is presented by a **Relative Quantification** item in the **Analysis tree**. Select the analysis item to view its data and settings.
4. Select the control sample from the **Control Sample** menu in the **Settings** field. This menu lists the samples that have been given a name in the **Sample Name** field in the layout.

Note
Before analyzing relative quantification data, make sure that you have valid Ct values.

## 11.2 Amplification Efficiency

The **Amplification Efficiency** tab provides the option of entering accurate values for PCR amplification efficiency to provide more accurate relative quantification results. The default value is 100%. The amplification efficiency values can be determined from a standard curve using the absolute quantification analysis and are entered per target and per fluorophore.

## 11.3 Settings

In the **Settings** field, you can define various view settings for relative quantification.

Tick **Replicate** to view the graph based on replicates and to view the standard deviation of replicates.

Select the **Fluorophores** to view by ticking them. This setting only affects the view and has no effect on the analysis.

Note
The settings for determining the Ct values are described in chapter 10. "Ct and Absolute Quantification" on page 31.

## 11.4 Results

The following information is presented in the results table:

**Well** – Well designation

**Fluorophore** – Fluorophore name

**Sample Type** – Sample type as specified in the layout

**Sample Name** – Name given to the sample in the layout

**Target** – Target as specified in the layout

**Description** – Optional description

**Relative Quantity** – Relation of the starting quantities of the target and the reference material

**Ct** – Cycle of threshold for the sample

**Delta Ct** – Difference in Ct between the reference gene and the target

**Delta Delta Ct** – Difference in Ct between the control and the sample

**Efficiency** – User-entered amplification efficiency used for the analysis

## 12. Allelic Discrimination

In the **Allelic Discrimination** analysis, the RFU or Ct values of **AD** standard groups are compared, and samples are classified as belonging to a certain group. **TurboQ** software groups the samples by calculating the distance between each sample and the averaged standard values.

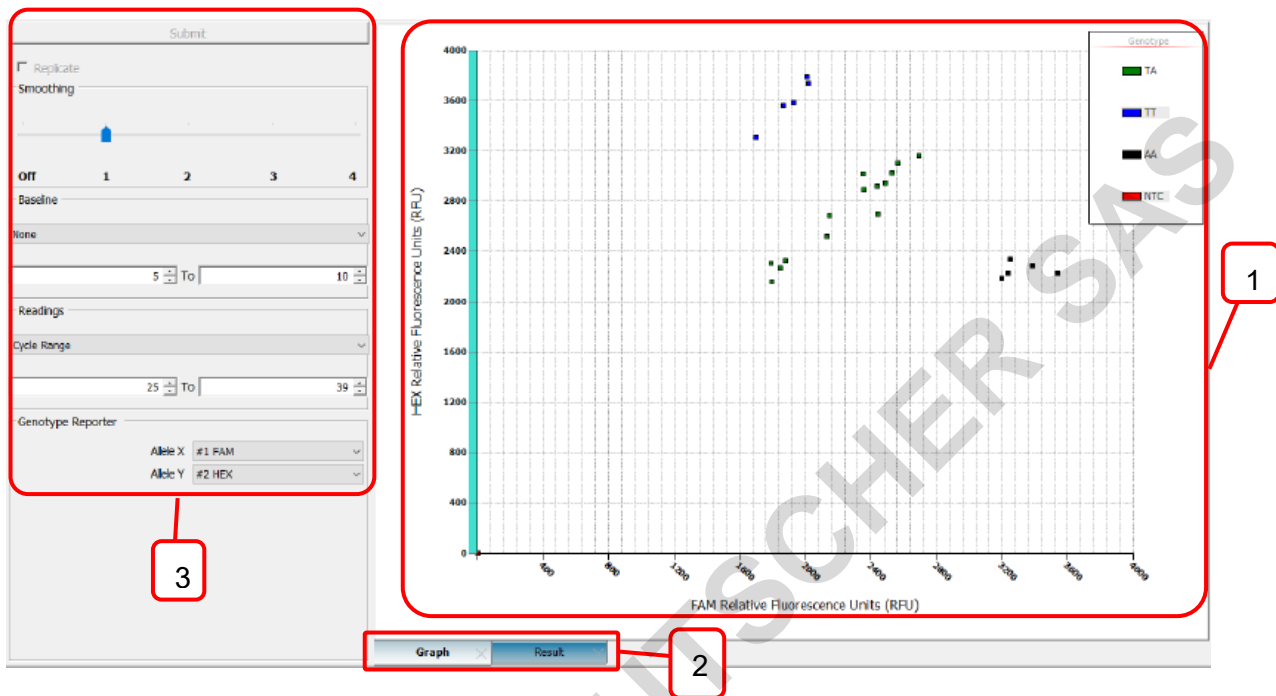

Figure 25. Allelic discrimination

The **Allelic Discrimination** analysis includes:

### 1. Allelic Discrimination Graph:

The graph shows different colors for each **AD/HRM** standard. The colors represent the values of the samples.

### 2. Results

The results table presents the RFU values of the selected channels as well as the genotype.

### 3. Settings

Setting for assigning fluorophores to the graph.

You can view the results for individual wells by selecting them in the **Well Selector**. Tick **Show All Wells**, if you wish the results table to show all available wells regardless of the well selection.

## 12.1 Layout Creation for Allelic Discrimination

Notes on creating a layout for allelic discrimination analysis:

Homozygote standards must have the **AD/HRM** standard sample type with the fluorophore with which they are detected. Their call must be defined in the layout by using the **Select** mode. The other fluorophore should have the **Empty** sample type.

For the heterozygote standards, both fluorophores should be defined as **AD/HRM** standards with the corresponding homozygote calls for both fluorophores.

No template control samples must have the **NTC** sample type for both fluorophores. **NTCs** are recommended but not mandatory.

## 12.2 Adding an Allelic Discrimination Analysis

You can base an allelic discrimination analysis on RFU or Ct values. To add an RFU-based allelic discrimination analysis:

1. In the **Analysis** view, select the main **Analysis** item in the **Analysis tree**.
2. Click the **RFU Based** button in the **Allelic Discrimination** action panel and select the sample group.

The RFU-based allelic discrimination analysis is presented by an **Allelic Discrimination (All Wells)** item in the root of the **Analysis tree**. Select the analysis item to view its data and settings.

To add a Ct-based allelic discrimination analysis:

1. In the **Analysis** view, select the **Ct** item for which the analysis is to be performed. The Ct item can encompass all wells or be the Ct of a distinct sample group.
2. Click the **Ct Based** button in the **Allelic Discrimination** action panel.

The Ct-based allelic discrimination analysis is presented by an **Allelic Discrimination** item under the chosen Ct item in the **Analysis tree**. Select the analysis item to view its data and settings.

## 12.3 Settings

In the **Setting** field, you can define settings for the allelic discrimination analysis. Note that settings differ based on whether you are performing an RFU- or Ct-based analysis.

In the **Genotype Reporter** field, you can select the fluorophores to plot for the X and Y axes.

Baseline is for you to select a certain cycle range as baseline to do normalization. Select none to deactivate normalization. You can also select a certain cycle range to read the result or read through all the cycles.

## 13. Melt Curve

The **Melt Curve** is a post-PCR analysis step performed on an amplified product. Typically, the analysis follows the amplification step and it utilizes an interchelating/dsDNA-binding dye, such as SYBR Green I.

The amplified product is subjected to a gradual increase in temperature, from the annealing temperature to about 95°C, while monitoring the fluorescence value every 0.5–1.0°C.

As a result of the temperature increase, the amplified product dissociates, that is, melts to form single-stranded DNA strands. The dsDNA binding dye molecules are released, which leads to a decrease in fluorescence.

The melting temperature,  $T_m$ , of the product is defined as the temperature at which half of the dsDNA products have melted. The melting temperature is a characteristic value for the amplification and it is calculated from the melting curve data by plotting the first negative derivative of the fluorescence plot.

The **Melt Curve** is used as a qualitative analysis of DNA products, for example, in the identification or characterization of PCR products. In addition, the analysis allows the user to check for unwanted PCR products, such as primer dimers and secondary amplification products and thus provides a tool for assay optimization.

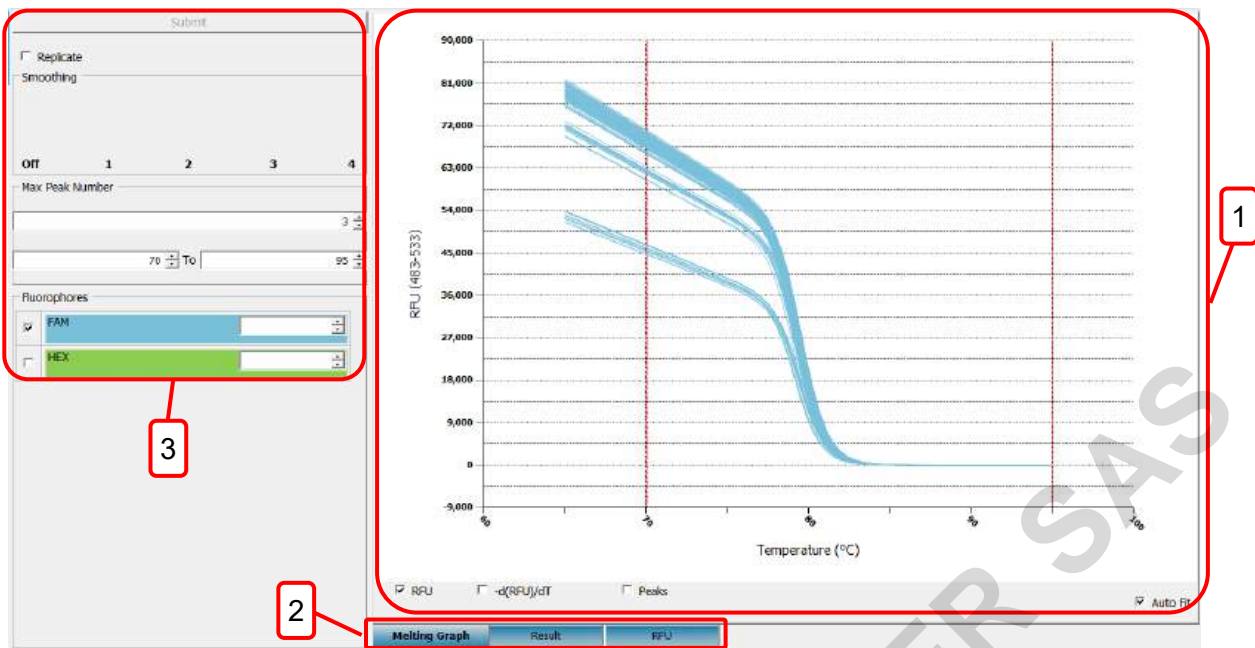

Figure 26. Melt curve

The **Melt Curve** analysis view includes the following main fields:

### 1. Display area

Display the selected data.

### 2. Results tab

The graph plots fluorescence values relative to the temperature and/or the first negative derivative of the fluorescence plot.

The results are presented as a table with melt temperature, and peak height for the selected fluorophores. The RFU readings for each sample during the melting are also provided.

### 3. Settings

- For viewing results for replicates or all wells.
- For applying curve smoothing.
- For selecting the number of peaks for which the data is shown in the results table.
- For showing the located peaks on the graph.
- For selecting the fluorophores for which the data is shown.

## 13.1 Adding a Melt Curve Analysis

A melt curve analysis that encompasses all layout wells (*Melt Curve*) is automatically added to the **Analysis tree** when the protocol includes a **Melt Curve** step.

## 13.2 Settings

Select the curves to view by ticking the boxes below the graph:

- Tick **RFU** to display the detected fluorescence. This curve typically decreases in signal intensity as the temperature increases.
- Tick **-d(RFU)/dT** to display the negative first derivative of the RFU curve. The curve presents the change in detected fluorescence relative to the change in temperature. The peak is used to determine the melting point. The derivative curve calculation algorithm automatically corrects for signal intensity decrease that is unrelated to DNA melting.
- Tick **Peaks** to view the located peaks, you can adjust the number of peaks at setting.

You can select to view individual fluorophores from the **Fluorophores** field and individual wells from the **Well Selector**.

Adjust the **Smoothing** slider to remove unwanted signal noise from the plotted graphs. Move the slider to the right to increase the smoothing effect. Move the slider completely to the left to disable smoothing.

## 13.3 Results

The results table presents the calculated melting curve data.

The following information is presented for each peak:

- **Melt Temp** – Detected melting point
- **Peak Height** – Highest value of the peak

## 14. High Resolution Melt Analysis

**HRM** or high-resolution melt analysis enables melt curve shape based identification of DNA products. **HRM** analysis is typically used for mutation analysis due to its capability to distinguish between single nucleotide differences.



Figure 27. High resolution melt analysis

The HRM view includes the following main fields:

### 1. HRM graph

The graph plots relative fluorescence against the temperature. You can view the graph with a normalized graph according to the selected temperature range. The  $\Delta$ RFU graph visualizes analysis data as the difference between individual melt curves and a virtual curve based on all available melt curves. The cluster visualizes analysis data based on detected melt curve peaks and their relative heights and locations on the temperature axis.

### 2. Results

The results show the melting peak(s).

### 3. Settings

**Smoothing:** The smoothing bar is for you to eliminate the background noise. The larger the number, the more background noise can be reduced. Slide to off to deactivate this function.

**Options:** If you have done **HRM Calibration**, tick **HRM Rectify** to have more accurate analysis. Input the number of peaks you want to include. Select a range for pre-melt and post-melt to normalize the curve.

**Fluorophores:** Select the **Fluorophores** to view by ticking them. This setting only affects the view and has no effect on the analysis.

DOMINIQUE DUTSCHER SAS

## 14.1 Adding an HRM Analysis

An **HRM** analysis can be added to a **Melt Curve** analysis item; either to all layout wells or to a **Melt Curve** analysis that is limited to a certain sample group.

To add an **HRM** analysis:

1. In the **Analysis** view, select the **Melt Curve** analysis item for which the analysis is to be performed.
2. Click the **HRMA** button in the **HRM** action panel.

The high-resolution melt analysis is presented by an **HRM** item in the **Analysis tree**. Select the analysis item to view its data and settings.

## 14.2 HRM Analysis and Results

The **HRM Graph** shows the selected source data for the high-resolution melt analysis. The setting of pre-melt and post-melt range is to correct for signal intensity decrease that is unrelated to DNA melting.

**HRM** analysis requires that standards are defined with the **AD** standard sample type in the **Plate Layout** view, and that a distinct call is given for each different standard. **TurboQ** software automatically calls all unknown samples to the standard with which they have the highest correlation.

Use the vertical temperature range bars in the **HRM Graph** to limit the area of interest, that is, the area of DNA melting. The area within the lower and upper range bars is used to normalize the data on the relative fluorescence axis. **TurboQ** software automatically defines a default range based on the data.

## 15. Settings

To access **TurboQ** software settings, click the **Settings** button in the **Home** view. In the **Settings** dialog, you can configure general software settings.

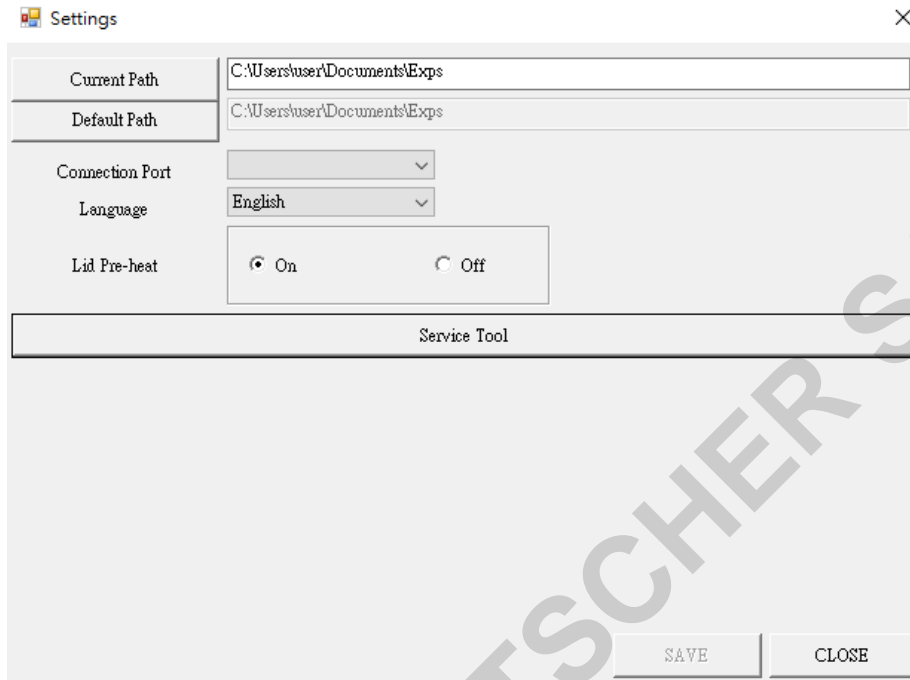

Figure 28. Settings

In the Settings, you can:

- Set the default folder for **TurboQ** software.
- Set the user interface language.
- Set the **Lid Pre-heat** on or off.

The service tool area is password protected and only authorized service engineers are allowed access.

Once you finish the setting change, you can click on the **SAVE** button to save changes, or you can click on the **CLOSE** button to ignore all the changes made.

### 15.1 Default Path

You can specify the default path for experiment storage by clicking on the **Current Path** button and select or create a folder, or you can type in the path in the field next to the **Current Path** button. You can reset the path to the system default path by clicking on the **Default Path** button.

## 15.2 Language

You can select the display language for **TurboQ** software in the language list. Currently there are three languages in the list: English, 简体中文 and 繁體中文. The selection will be applied on the next **TurboQ** software start up.

## 15.3 Lid Pre-Heat

The lid heater can be pre-heated to 60°C after **TurboQ** start up. This can reduce the time needed for the lid heater to reach the working temperature when you start running a protocol. You can change the setting to enable or disable the **Lid Pre-Heat**.

## Appendix A: Technical Specifications

<b>Sample Block</b>	
Sample Block	Fixed 96-well, compatible with regular profile or low profile 0.1/0.2 ml PCR tube, strip, non-skirted, semi-skirted and full-skirted 96-well plate
Sample Volumes	10-100 $\mu$ L
Plate Loading	Motorized plate carrier tray
<b>Block Temperature</b>	
Block Temperature Range	25 - 99 $^{\circ}$ C
Peak Block Ramp Rate	6.6 $^{\circ}$ C/sec
Temperature Accuracy	<ul style="list-style-type: none"> <li>• <math>\pm 0.25</math> <math>^{\circ}</math>C (35 <math>^{\circ}</math>C – 95 <math>^{\circ}</math>C) of set point/ display temperature</li> <li>• Measured at 3 minutes after clock start.</li> </ul>
Temperature Uniformity Across Block	$\pm 0.5$ $^{\circ}$ C (30 seconds after clock start)
<b>Gradient Temperature</b>	
Gradient Operative Temperature Range	60 - 99 $^{\circ}$ C
Gradient Temperature Difference	Max. span 25 $^{\circ}$ C
<b>Heated Lid</b>	
Heating Lid	105 $^{\circ}$ C
<b>Optics</b>	
Excitation Source	Tungsten-halogen lamp
Detection Module	CCD camera

Detection Channel	<p>4 channels</p> <ul style="list-style-type: none"> <li>● Ch1: FAM, SYBR Green</li> <li>● Ch2: HEX, VIC, JOE</li> <li>● Ch3: ROX, Texas Red</li> <li>● Ch4: Cy5</li> </ul>
<b>Environment</b>	
Operating Temperature	15 - 30 °C
Operating Humidity	0 ~ 85% RH
Storage Temperature	-10 - 60 °C
<b>General</b>	
Footprint Dimensions (H x W x D)	567 mm x 354 mm x 455mm
Weight	35 kg
Power supply	110/230 V, frequency 50/60 Hz, 1500W
Fuse	1 x fuse, 10A for 110VAC power / 5A for 220VAC power

## Appendix B: CE Declaration



**BLUE-RAY BIOTECH CORP.**

5F., No.2, Aly.2, Siwei Ln., Zhongzheng Rd., Xindian  
Dist., New Taipei City 23148, Taiwan (R.O.C.)

### **Declaration of Conformity**

**Product Name:** TurboQ

**Model Names:** TCRT-9614 / TCRT-9624

All models comply with the following European standards:

**EMC:** EN 61326-1

**Safety:** IEC/EN 61010-1 (Third Edition) : 2010

IEC 61010-2-101 : 2002

To the best of my knowledge and belief, these units conform to these standards.

Name: Jimmy Kao

Position: Quality Assurance Manager

Issue Date: 2016. 12. 13

## Appendix C: Order Information

Cat. No.	Description
<b>TCRT-9614</b>	Real-Time PCR TurboQ Ch1,2,4,5 110V
<b>TCST-9624</b>	Real-Time PCR TurboQ Ch1,2,4,5 220V
<b>TCRT-C001</b>	TurboQ 4Ch Calibration Kit

DOMINIQUE DUTSCHER SAS

 **Arise Biotech Corp.**

5F., No.2, Aly.2, Siwei Ln., Zhongzheng Rd., Xindian Dist., New Taipei City 23148, Taiwan (R.O.C.)

<https://www.arisebio.com.tw/en/>

**Blue-Ray Biotech Corp.**

5F., No.2, Aly.2, Siwei Ln., Zhongzheng Rd., Xindian Dist., New Taipei City 23148, Taiwan (R.O.C.)

[www.blue-raybio.com](http://www.blue-raybio.com)