

TurboCycler 2

Gradient Thermal Cycler

TCST-9612 / TCST-9622

Operation Manual

Ver. 2.2













Copyright © 2023 Blue-Ray Biotech Corp.
All Rights Reserved.

DOMINIQUE DUTSCHER SAS

Table of Contents

1. Safety Precautions	1
1.1 Intended Use.....	1
1.2 Safety Label	1
1.3 General Instrument Safety.....	1
1.4 Chemical Safety	2
1.5 Chemical Waste Safety	3
1.6 Electrical Safety	3
2. General Description	4
2.1 Features	4
2.2 Product Overview.....	5
3. Getting Started	8
3.1 Unpacking.....	8
3.2 Initial Operation.....	8
3.3 Lid Opening/Closing	9
3.4 Heated Lid.....	10
3.5 Loading the Reaction Vessel.....	11
3.6 Main Screen.....	12
4. User Folder Management	13
4.1 Creating a New User Folder.....	13
4.2 Viewing a User Folder.....	13
4.3 Editing a User Folder	14
4.4 Deleting a User Folder	14
4.5 Using USB Flash Drive as a User Folder	14
5. Protocol Management	15
5.1 Creating a New Protocol.....	15
5.2 Saving a Protocol.....	19
5.3 Editing (Viewing) a Protocol.....	19
5.4 Deleting a Protocol.....	19
6. Protocol Running Management	20
6.1 Running a Protocol	20
6.2 Monitoring the Protocol Running Status.....	21
6.3 Pausing a Running Protocol	22
6.4 Terminating a Running Protocol	22

7. Tools	23
7.1  Tm Calculator	23
7.2  Incubator	23
7.3  Copy Number Converter	23
7.4  Mastermix Preparation Wizard	23
7.5  Help	23
8. System Setup	24
8.1  Brightness	24
8.2  Beep Sound	24
8.3  Date & Time	24
8.4  Wi-Fi	24
8.5  Administration	24
8.6  Service Mode	24
9. Maintenance	25
9.1 Cleaning the Unit	25
9.2 Cleaning the Heated Lid	25
9.3 Replacing a Fuse	25
10. Troubleshooting	26
10.1 Error Messages	27
Appendix A: Technical Specifications	29
Appendix B: Template Protocols	30
Appendix C: Wi-Fi	32
I. Configure the Wi-Fi Module	32
II. Install the TurboApp for the Mobile Device	32
III. Configure the TurboApp	32
IV. TurboApp Status Screen	33
Appendix D: CE Declaration	34
Appendix E: Order Information	35

1. Safety Precautions

Before using the **TurboCycler 2** for the first time, please read this entire operation manual carefully. To guarantee problem free, safe operation of the **TurboCycler 2**, it is essential to observe the following section.

1.1 Intended Use

This instrument is intended to be used by trained personnel to perform PCR. In this manual we assume the user to have knowledge of basic laboratory procedures and PCR chemistry.

1.2 Safety Label



High Temperature Label: Please be aware of the heated components.

1.3 General Instrument Safety

PHYSICAL INJURY HAZARD. Using the instrument in a manner not specified by Blue-Ray Biotech may result in personal injury or damage to the instrument.

1.3.1 Transportation and Storage

This instrument should be transported or stored in an environment with a temperature of -20 ~ 60 °C, relative humidity 20 ~ 80%.

1.3.2 Installation and Operation

1. Do not use the device in a potentially explosive environment or with potentially explosive chemicals.
2. Install the device in a location free of excessive dust.
3. Avoid placing the device in direct sunlight.
4. Choose a flat, stable surface capable of bearing the weight of the device.
5. Install the device in a room with a temperature of 15 ~ 30 °C, relative humidity 20 ~ 80%.
6. **MAKE SURE** the air vents are unobstructed.
7. Keep the front and rear of the device at least 10 cm from the wall or other equipment.
8. Make sure the power source conforms to the required power supply specifications.
9. To avoid electric shock, make sure the device is plugged into a grounded electrical outlet.
10. Do not allow water or any foreign objects to enter the various openings of the device.

1.3.3 Cleaning, Decontaminating and Servicing the Instrument

Before using a cleaning or decontamination method other than those recommended by the manufacturer, verify with the manufacturer that the proposed method will not damage the

equipment.

Switch off and unplug the device before cleaning, servicing, or replacing the fuses.

Repairs should be carried out by authorized service personnel only.

1.3.4 Instructions for Disposal

Do not dispose of this product as unsorted municipal waste. Follow local municipal waste ordinances for proper disposal provisions to reduce the environmental impact of waste electrical and electronic equipment (WEEE).

European Union customers:

Call your local Blue-Ray Biotech Customer Service office for equipment pick-up and recycling.

1.4 Chemical Safety

1.4.1 Chemical Hazard Warning

CHEMICAL HAZARD. Before handling any chemicals, refer to the Material Safety Data Sheet (MSDS) provided by the manufacturer, and observe all relevant precautions.

1.4.2 About MSDSs

Chemical manufacturers supply current Material Safety Data Sheets (MSDSs) with shipments of hazardous chemicals to new customers. They also provide MSDSs with the first shipment of a hazardous chemical to a customer after an MSDS has been updated. MSDSs provide the safety information you need to store, handle, transport, and dispose of the chemicals safely.

Each time you receive a new MSDS packaged with a hazardous chemical, be sure to replace the appropriate MSDS in your files.

1.4.3 Chemical Safety Guidelines

To minimize the hazards of chemicals:

- Read and understand the Material Safety Data Sheets (MSDSs) provided by the chemical manufacturer before you store, handle, or work with any chemicals or hazardous materials. (See **“About MSDSs” in Section 1.4.2**)
- Minimize contact with chemicals. Wear appropriate personal protective equipment when handling chemicals (for example, safety glasses, gloves, or protective clothing). For additional safety guidelines, consult the MSDS.
- Minimize the inhalation of chemicals. Do not leave chemical containers open. Use only with adequate ventilation (for example, fume hood). For additional safety guidelines, consult the

MSDS.

- Check regularly for chemical leaks or spills. If a leak or spill occurs, follow the manufacturer's cleanup procedures as recommended in the MSDS.
- Comply with all local, state/provincial, or national laws and regulations related to chemical storage, handling, and disposal.

1.5 Chemical Waste Safety

1.5.1 Chemical Waste Hazard

HAZARDOUS WASTE. Refer to Material Safety Data Sheets and local regulations for handling and disposal.

1.6 Electrical Safety

ELECTRICAL SHOCK HAZARD. Severe electrical shock can result from operating the TurboCycler 2 without its instrument panels in place. Do not remove instrument panels. High-voltage contacts are exposed when instrument panels are removed from the instrument.

1.6.1 Fuses

FIRE HAZARD. Improper fuses or high-voltage supply can damage the instrument wiring system and cause a fire. Before turning on the instrument, verify that the fuses are properly installed and that the instrument voltage matches the power supply in your laboratory.

FIRE HAZARD. For continued protection against the risk of fire, replace fuses only with fuses of the type and rating specified for the instrument.

1.6.2 Power

ELECTRICAL HAZARD. Grounding circuit continuity is vital for the safe operation of equipment. Never operate equipment with the grounding conductor disconnected. Use properly configured and approved line cords for the voltage supply in your facility. Plug the system into a properly grounded receptacle with adequate current capacity.

2. General Description

The **TurboCycler 2** is a powerful, reliable and affordable thermal cycler. It is equipped with a gradient function that enables the user to set a maximum 30°C temperature gradient between the left and right rows in the sample block at each temperature.

2.1 Features

- Flexible ramp rate control
- Easy-to-operate lid design.
- Large LCD touch panel enhances visibility and ease-of-operation.
- Heated lid to prevent the formation of condensation.
- Robust and modern outlook design.
- Air intake vents on the front and exhaust vents on the rear reduce heat-based interference with other equipment.
- Optional Wi-Fi module allows remote monitoring of your experiment's running status.
- Simple and easy-to-use graphical interface.
- Gradient function enables optimization of annealing temperatures.
- Temperature increment/decrement function makes touchdown PCR possible.
- Preset protocol templates make starting amplification easier.
- Automatically creates operating history and error logs.
- Auto restart of a running protocol after power failure.

2.2 Product Overview

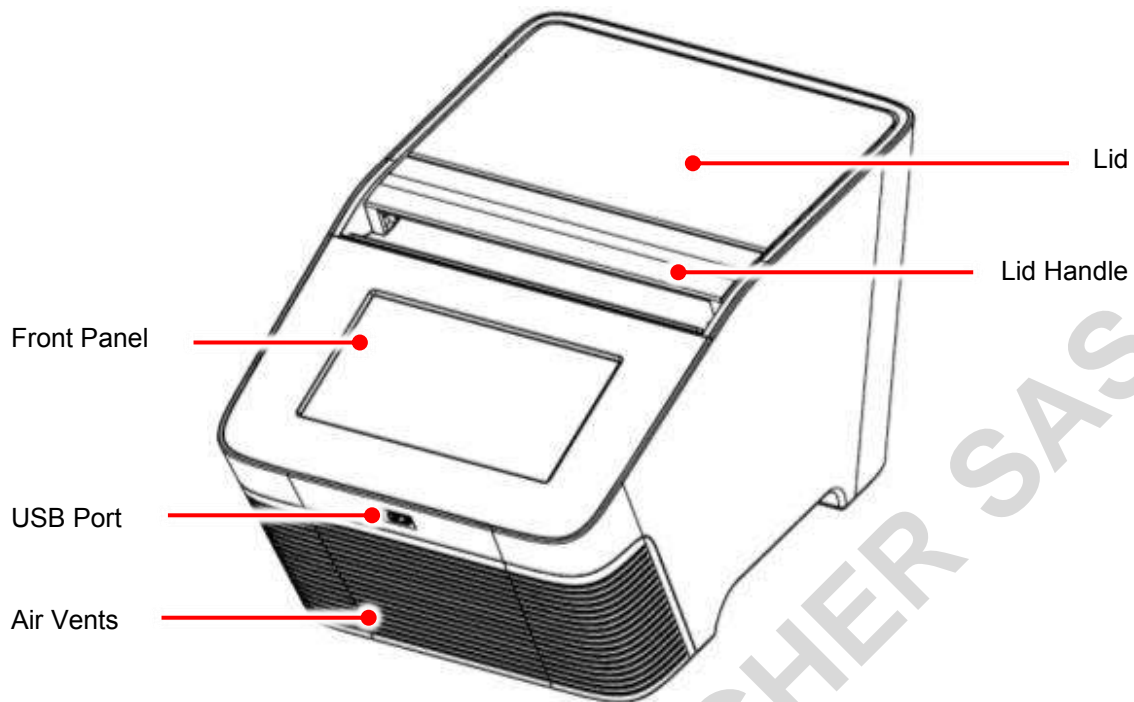

Figure 1. Top view

Table 1. Detailed description for top view

Name	Function
Front Panel	7" high resolution color LCD display with capacitive touch panel. It displays the current status of the system and allows the user to operate the instrument.
USB Port	For protocol and run log output via USB flash drive.
Air Vents (Front)	For air intake.
Lid	The heated lid is designed to prevent the condensation inside the reaction vessels during the PCR temperature cycling.
Lid Handle	Easy-to-operate handle without tedious rotating mechanism, designed to withstand long-term operation.

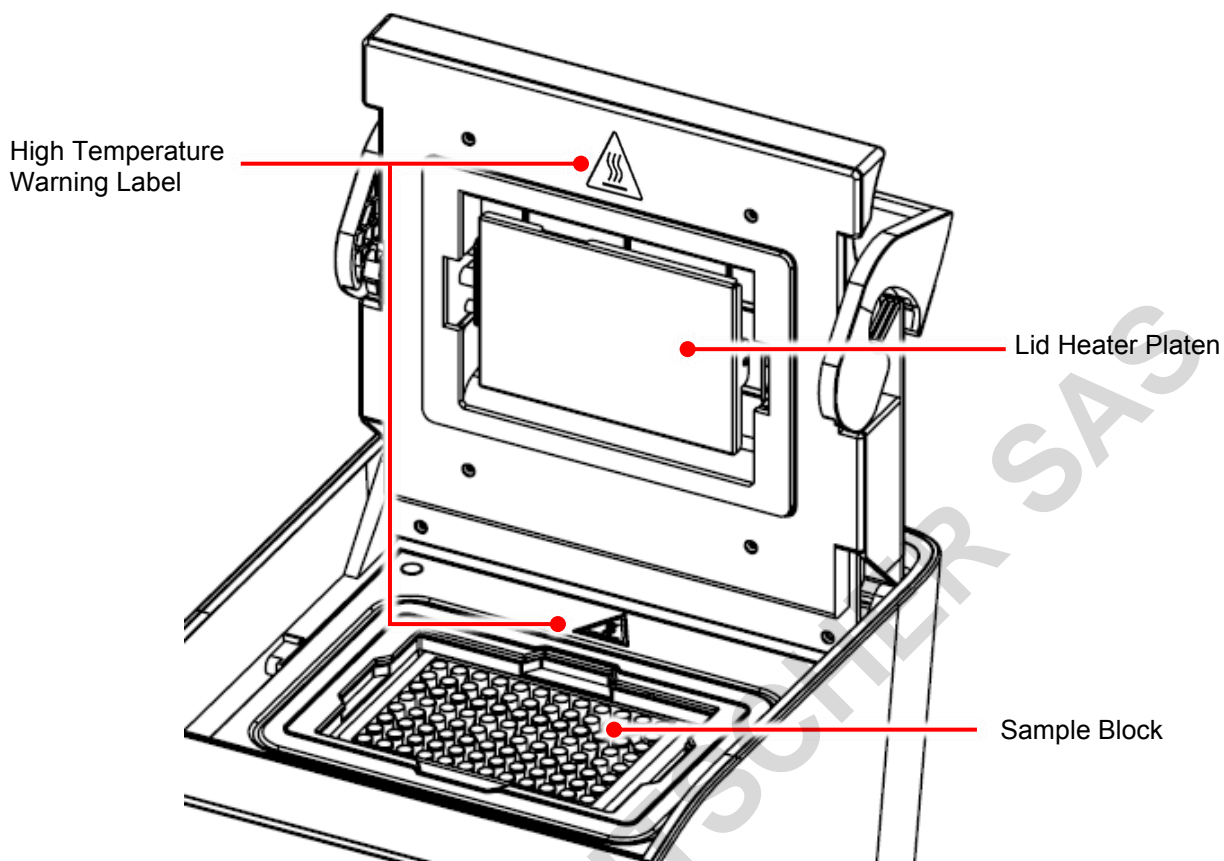

Figure 2. Top view with opened lid

Table 2. Detailed description for top view with opened lid

Name	Function
High Temperature Warning Label	During and after PCR operation, the lid heater platen and the sample block may become very hot (up to 120°C). Please be aware of the high temperature.
Lid Heater Platen	The heater platen is designed to prevent the condensation problem inside the reaction vessels and to place consistent pressure to the top of the reaction vessels. This pressure will ensure an efficient contact between the reaction vessels and the sample block for better heat conduction. It will also help prevent the leakage of sample vapor due to the weak vessel caps or sealing.
Sample Block	Section of the unit to hold the reaction vessels.

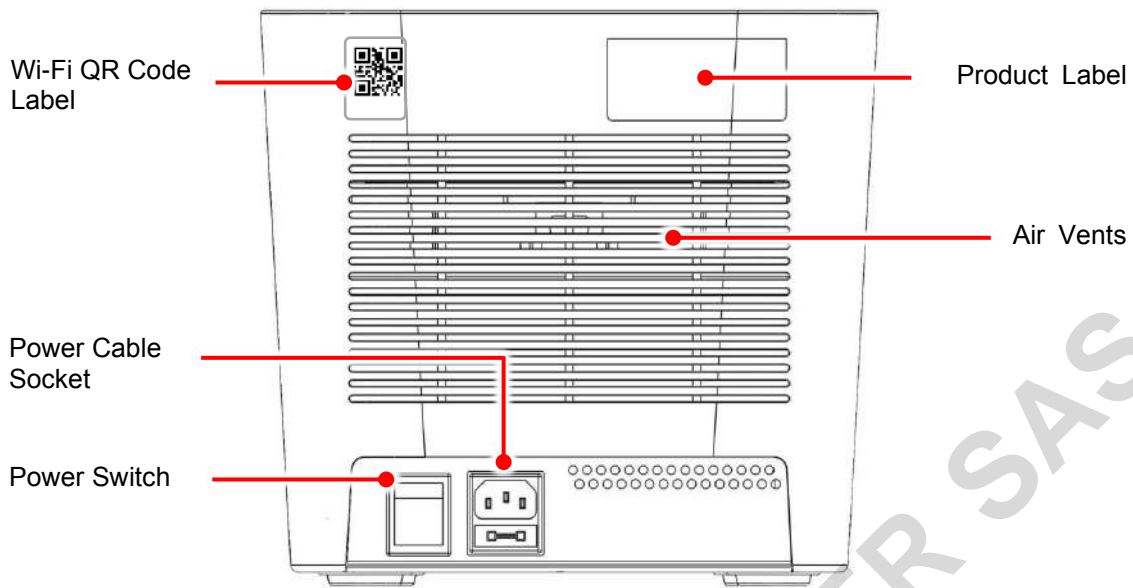

Figure 3. Rear view

Table 3. Detailed description for rear view

Name	Function
Wi-Fi QR Code Label	Display the device name and the QR code for the Wi-Fi module. (optional)
Power Cable Socket	Power cable socket and fuse compartment.
Power Switch	Power On/Off switch.
Product Label	Indicates the model's name, serial number, power specification, and other important information.
Air Vents (Rear)	For air output.

3. Getting Started

3.1 Unpacking

Open the **TurboCycler 2** package and confirm that all items below are included:

- **TurboCycler 2** unit x 1
- Quick operation guide x 1 (with QR code for downloading Operation Manual)
- Calibration report x 1
- Warranty card x 1
- 5.2 mm compression mat x 1
- 1.0 mm compression mat x 1
- European AC power cord x 1
- American standard AC power cord x 1
- Spare electric fuses (10 A) x 1

If there are any items missing, damaged, or any incorrect items in the package, please contact your distributor or sales representative immediately.

3.2 Initial Operation

Place the device on a steady, flat table. Keep the front and rear of the device at least 10cm from the wall or other devices. Check that the power source is compatible with your device's fuse rating input. Connect the power cord to the power socket at the rear of the device.

Switch on the device using the power switch at the rear of the device. The LCD display will show the boot screen and then the "**TurboCycler**" title will be displayed. Tap on the "**TurboCycler**" title to log into the **Main Screen** and start your operation. Tap on the "**TurboCycler**" title again on the **Main Screen** to log out.

Switch off the device when not in use.

3.3 Lid Opening/Closing

To open the lid, pull the handle upward and lift the lid backward as shown in Figure 4 to the upright position.

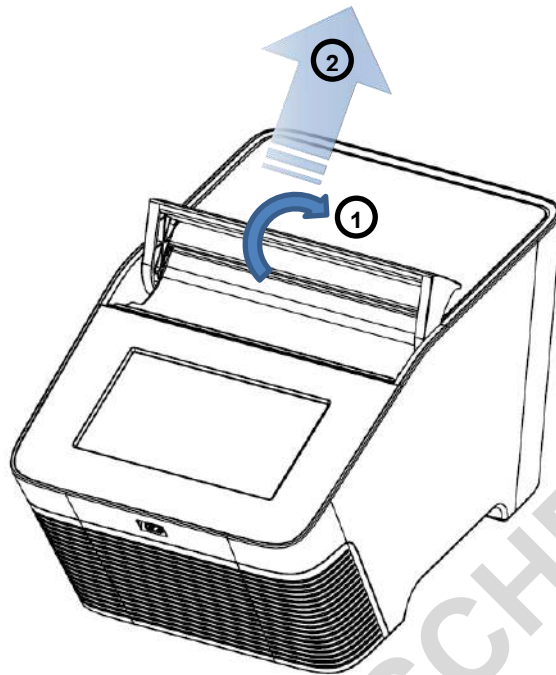

Figure 4. Opening the lid

To close the lid, pull the lid downward and close the handle to the lock position as shown in Figure 5

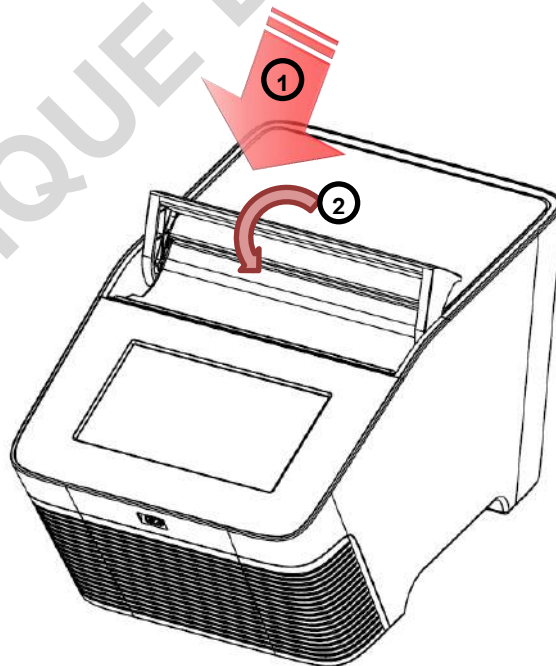

Figure 5. Closing the lid

3.4 Heated Lid

The Heated Lid heats the air in the upper part of the sample vessels at a higher temperature than the reaction mixture. This prevents condensation of the evaporated water vapor on the vessel walls, keeping the concentration of the reaction mixture unchanged during the heating and cooling cycles. The heater platen also applies pressure on the caps or sealing film on the vessels to prevent vapor loss and cross contamination of samples.

Due to the height difference between the standard profile vessels and the low profile vessels, it is required to use the 5.2 mm **Compression Mat** (standard accessory shipped with **TurboCycler 2**) for low profile vessels. The Compression Mat will help placing even and sufficient pressure on the caps or sealing on the vessels. Please refer to Table 4 for further information.

Table 4. Lid heater setting guide

PCR vessels	Compression mat	Lid heater temperature
Regular PCR plate, tube-strips and tubes	Not necessary. The 1.0 mm compression mat can be used to help maintaining the sealing integrity in case the PCR plate has any imperfection on the rim of the well.	105°C
Low profile PCR plate, tube-strips and tubes	The 5.2 mm compression mat must be used to ensure sufficient contact pressure from the heated lid.	120°C

Note
<ol style="list-style-type: none"> If TurboCycler 2 is started cold, approximately two to three minutes will be required for the heater platen to reach the setting temperature. If the low profile reaction vessels and the 5.2 mm compression mat are used, an extra three minutes will be required to allow the compression mat to be heated to the required 120°C temperature. The extra 5.2 mm Compression Mat can be purchased separately (Cat. # TCST-a002, pack of 10 mats). The extra 1.0 mm Compression Mat can be purchased separately (Cat. # TCST-a003, pack of 10 mats).

3.5 Loading the Reaction Vessel

For the optimal performance of the **TurboCycler 2**, the recommended sample volume for 0.2 ml tubes or 96-well plates is 5-100 μl . For low profile vessels, it is required to use a 5.2 mm Compression Mat which will help placing even and sufficient pressure on the caps or sealing on the vessels, and the recommended sample volume is 5-50 μl .

To apply the compression mat, follow the instruction shown in Figure 6.

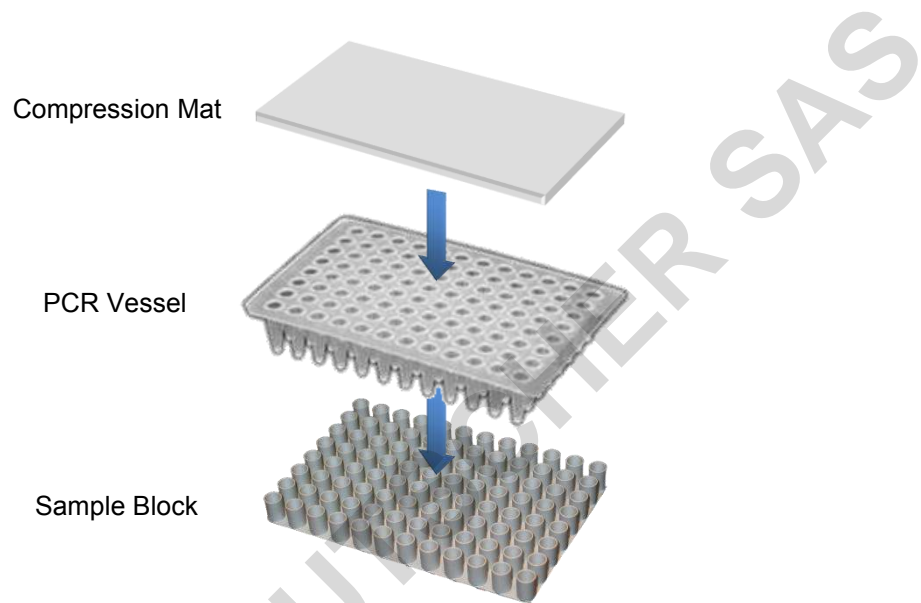

Figure 6. Applying the compression mat

In order to prevent the deformation of the PCR vessels, and to ensure even distribution of the pressure from the lid, when PCR tubes or tube-strips are used, please load extra empty tubes on the 4 corners of the sample block as shown in Figure 7. Always make sure that all the sample tubes/ tube-strips are distributed evenly on the sample block.

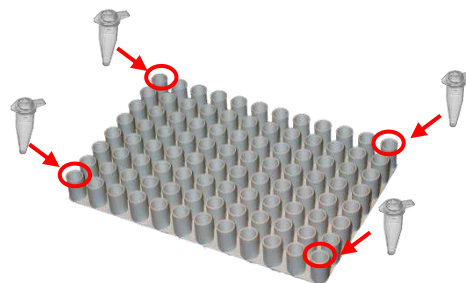

Figure 7. Loading extra tubes

3.6 Main Screen

On the **Main Screen** there are some information items indicate the status of the **TurboCycler 2**, it also contains 8 main function icons. Please refer to the following Figure 8 and Table 5 for the detailed description.

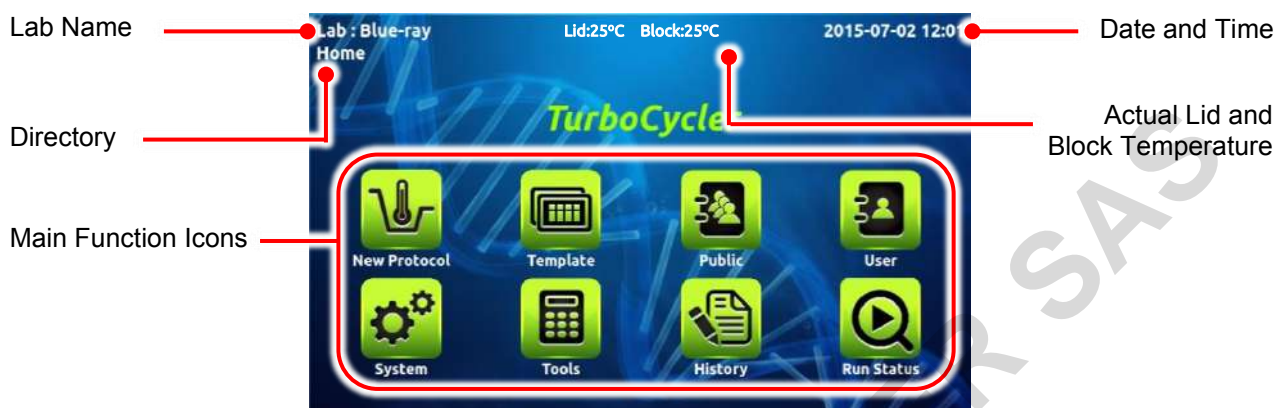

Figure 8. Main screen overview

Table 5. Main function icons

Main function icons	
	New Protocol For new protocol creation and editing
	Template Built-in protocol template
	Public Short cut to the public folder
	User For user folder management
	System System setting
	Tools Built-in assistant tools
	History Protocol run history logbook
	Run Status Display the status of the running protocol

4. User Folder Management



Tap on the **User** icon  on the main screen to enter the **User Folder** management screen. A sample screen is shown in Figure 9 below.



Figure 9. User folder overview

All Protocols are stored inside the user folders. There are 8 user folders displayed in one page. If there are more than 8 user folders registered in the system, you can slide up or down on the screen or tap on  to see the other pages.

The lock symbol  on the lower right corner of the folder icon indicates that the folder is password protected.

Users can utilize the function icons on the lower part of the screen to open, create, edit and delete the user folders. The **Home** icon is used to return to the **Main Screen**.

Note

The **Public** folder is a preset folder which cannot be deleted and requires no password to enter.

4.1 Creating a New User Folder

On the **User Folder** screen, tap on the **New** icon  to create a new User Folder. Input the folder name and password (optional). Tap the user icon (10 different male and female icons are available) to change the icon for the new folder.

4.2 Viewing a User Folder



To view the contents in a **User Folder**, tap on the folder icon to select and highlight it. You can then tap for the second time or tap on the **Open** icon  to open it. If the folder is password protected, you'll be requested to input the password. Input the password and tap on **OK** to confirm the password or tap on **CANCEL** to abort the operation. If the password is entered correctly, the folder

will then be opened. If the password is entered incorrectly, a warning message box will pop up indicating the wrong password was inputted. Tap on  to return to the password input screen and input the correct password. To run a Protocol, please refer to Section 6.1.

4.3 Editing a User Folder

To edit the properties of a **User Folder**, tap on the folder icon to select and highlight the folder, then tap on the **Edit** icon  to edit it. You can change the folder name and password (optional) or change the icon you want to use for the folder. Tap on OK to store and finish the editing.

4.4 Deleting a User Folder

To delete a **User Folder**, tap on the folder icon to select and highlight the folder, then tap on the **Delete** icon  to delete it. You are required to enter the password if the folder is password protected. The screen will prompt "Do you want to delete the folder?". Tap on  to confirm the deletion. Tap on  to abort the deletion.

Note

User folders which contain any protocols cannot be deleted. You should delete all the protocols in them first.

4.5 Using USB Flash Drive as a User Folder

You can use a USB flash drive as a **User Folder** to keep your protocols. You can also use the USB flash drive to transfer the protocols between different **TurboCycler 2 units**. Please insert your USB flash driver into the front USB port and wait for 5-10 seconds (depends on the specification of the flash drive. It is recommended to format your flash drive in FAT or FAT32 file system prior to use it on **TurboCycler 2**) for the **TurboCycler 2** to recognize it and create required folder in it. Tap on the **USB** icon  to open the specific folder (\\TPCR_Files) in the flash drive and use it as a **User Folder**.

5. Protocol Management



After entering the selected User Folder, the protocol list will be displayed. A sample screen is shown as Figure 10 below. Users can utilize the function icons on the lower part of the screen to edit, create, delete, duplicate (save as new protocol) and open the protocols. The **Back** icon  is used to return to the **User Folder** screen.



	Name	Date & Time
1	2-step	2015-03-26 14:35
2	3-step	2015-03-26 14:35
3	Gradient	2015-03-26 14:35
4	Touch down	2015-03-26 14:35
5		
6		
7		

Figure 10. Protocol list

5.1 Creating a New Protocol

A new Protocol can be created by going to the User Folder and tapping on the **NEW** icon , a new protocol with a standard template will be created in the folder. Alternately, you can tap on the **New Protocol** icon  on the Main Screen. In this way, the new protocol can be saved to any selected User Folder later. The protocol editing screen is shown as Figure 11 below.

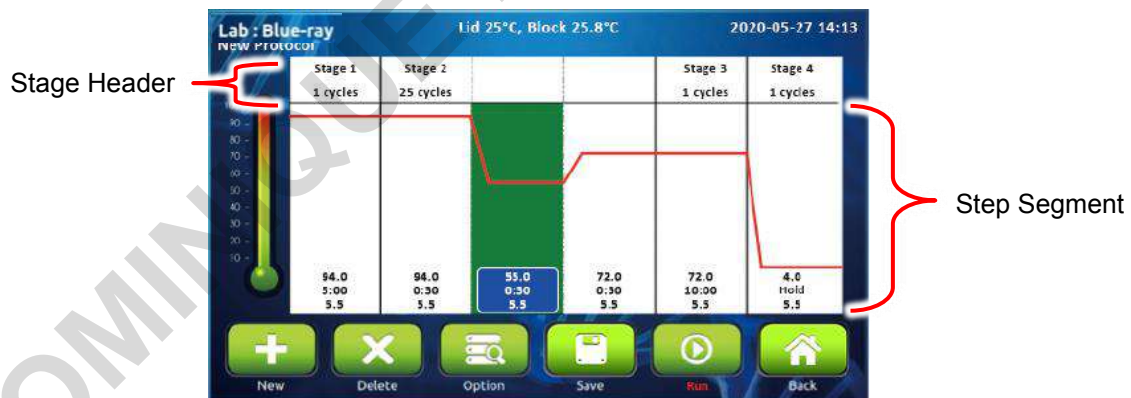





Figure 11. Standard protocol template

During your editing, if the **Protocol** contains too many **Stages/Steps** that cannot be completely displayed on the screen, you can slide right or left on the screen to see the other part of the **Protocol**.

You can also use the built-in protocol templates as your start point for a new protocol by tapping on the **Template** icon  on the **Main Screen** and choose one of the templates in it. Please refer to **Section 5.3 Editing (Viewing) a Protocol** for detailed instructions.

5.1.1 Changing Temperature/Time/Ramp Rate Setting

- To select the **Step**, tap on the step segment. The selected **Step** will be highlighted and the **Step Temperature, Time and Ramp Rate**  will be displayed. Tap on  and a spinning wheel will pop up as shown in Figure 12, allowing you to modify the **Step Temperature, Step Time or Step Ramp Rate**.

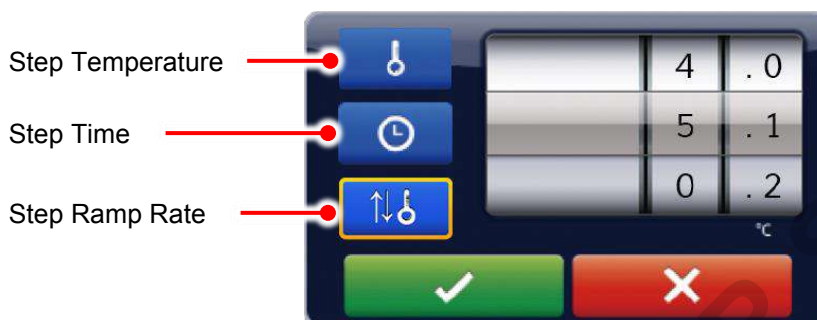



Figure 12. Temperature/Time/Ramp rate setting

- Tap on the **Temperature, Time or Ramp Rate** setting function icon and spin the wheel to the desired value. Tap on  to accept the setting. Tap on  to abort the operation.

The temperature and time ranges are shown below.

Temperature range: 4.0 to 100°C



Time range (minute: second): 00:01 to 99:59

Ramp Rate range: 0.1 to 5.5 °C/sec.

Note

If the last **Stage** contains only one **Step** segment, the ∞ check box will be activated in the **Time** setting spinning wheel, allowing you to set the infinity hold at the end of the protocol.





5.1.2 Inserting/Deleting a Stage or Step Segment

Tap on the **Stage** header or the **Step** segment. The selected area will be highlighted. Tap on the **New**  or the **Delete**  function icon to duplicate or delete the selected **Stage/Step**.

Note

- If you delete all the **Steps** in a **Stage**, the entire **Stage** will be deleted.
- If there is only one **Stage** left in the protocol, it cannot be deleted.
- In a **Stage** which contains only one **Step**, if you duplicate the **Step**, the **Stage Cycle Number** will be set to 2. Please refer to **Section 5.1.3 Changing Stage Cycle Number** for further instruction.

5.1.3 Changing Stage Cycle Number

If a **Stage** contains more than one **Step** segment, the **Stage Cycle Number**  will appear when you tap on the **Stage** header to highlight it. The **Stage Cycle Number** indicates the total number of times the Stage will repeat itself during the protocol running. Tap on  and the **Cycles** spinning wheel will pop up as shown in Figure 13 below, allowing you to modify the **Stage Cycle Number**. Spin the wheel to the desired number and tap on  to accept the setting or tap on  to abort the operation.

The Stage Cycle Number range: 2 to 99.



Figure 13. Cycle number setting

5.1.4 Advanced Option Settings

Users can set up the following advanced option functions for the **Steps** in a multi-step **Stage**:

- 1) **Gradient**
- 2) **Temperature Increment/Decrement**
- 3) **Time Increment/Decrement.**

Tap the specific **Step** to highlight it and tap on the **Option** icon . The **Option** spinning wheel shown in Figure 14 will be displayed.



Figure 14. Advanced option



5.1.4.1 Gradient Temperature Setting

Tap on the **Temperature Gradient** setting function icon, spin the wheel to the desired value for the gradient temperature span from the original temperature of the **Step**. The value 00.0 turns off the **Gradient**.

The Gradient temperature ranges are shown below.

Temperature range for gradient option: 30.0 to 100.0°C

Gradient temperature span: 0.1 to 30.0°C

1. Tap on  to accept the setting or tap on  to abort the operation. A table will pop up displaying the calculated gradient temperature from column 1 to 12. Tap on  to confirm the setting.



Note

The temperature values between the 2nd and 11th columns are calculated values and represent an algorithmic based on the heat distribution throughout the sample block.

5.1.4.2 Temperature Increment/Decrement Settings

1. Tap on the **Temperature Increment/Decrement** setting function icon, spin the wheel to the desired value for the temperature increment/decrement per cycle. The value 0.0 turns off the **Temperature Increment/Decrement**.

Max. Temperature incremental/decrement value: +/- 9.9°C

2. Tap on  to accept the setting or tap on  to abort the operation.



Note

Temperature limits 4.0°C to 99.9°C. DO NOT exceed.

5.1.4.3 Time Increment/Decrement Settings

1. Tap on the **Time Increment/Decrement** setting function icon, spin the wheel to the desired value for the time increment/decrement per cycle. The value 0.0 turns off the **Time Increment/Decrement**.



Max. Time increment/decrement value (minute : second): +/- 9:59

2. Tap on  to accept the setting or tap on  to abort the operation.

Note

Time limits 99:59. DO NOT exceed.

5.2 Saving a Protocol



After all settings are entered, tap on the **Save** icon  to store the protocol. Input the protocol name in the pop-up screen and tap on "OK". If you create your new protocol from the **Main Screen**, you'll then be brought to the **User Folder** selection screen. Tap on a **User Folder** icon to select the folder, and then tap on  to save to the folder. Alternately, you can tap on the **USB** icon  to save the protocol to the USB flash drive inserted. If you create your new protocol in a **User Folder**, after you input the protocol name and tap on "OK", the protocol will be saved to the folder directly.

5.3 Editing (Viewing) a Protocol

To edit a **Protocol** in the User's protocol list, tap on the **Protocol** name to select it first. The selected **Protocol** will be highlighted. You can then tap it the second time or tap on the **Open** icon  to open it. Please refer to **Section 5.1.1~5.1.4** to edit the temperature segment and numerical values, and other advanced functions. After all settings are edited, please refer to **Section 5.2** to save the edited **Protocol** to the original folder. An edited **Protocol** can be saved under a new name (as a newly created **Protocol**) or under the same name (overwrite the original **Protocol**).

You can use the **Edit Name** icon  to change the **Protocol** name.

5.4 Deleting a Protocol

Tap to select the **Protocol** to be deleted. The selected **Protocol** will be highlighted. You can then tap on  the **Delete** icon to delete it. A dialog box will pop up requesting you to confirm the operation. Tap on  to confirm the deletion. Tap on  to abort the operation.

Note
Protocols in the Template folder can't be deleted.

6. Protocol Running Management



Caution: During the protocol running, the lid heater and the sample block may become very hot. Please be aware of the high temperature.

6.1 Running a Protocol

Please refer to *Section 5.3 Editing (Viewing) a Protocol* to open and check the setting of a Protocol.

Tap on **Run** icon  to initiate the run. Users are requested to select the temperature control mode of the **Lid Heater** and the **Sample Block**.

- 1 **Lid Heater** temperature control mode.

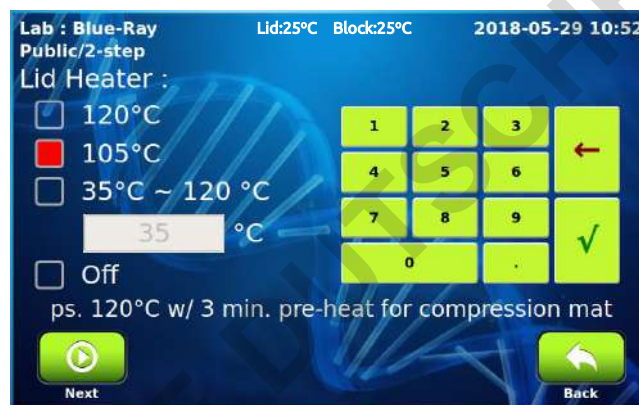



Figure 15. Lid heater control mode

Please refer to *Section 3.4* for detailed information. Tap on the **Next** icon  to go to the **Sample Block** temperature control mode screen.

- 2 **Sample Block** temperature control mode:
 - i. **Block Mode:** Enables system operation with maximum temperature control based on the actual block temperature regardless of the sample temperature. This mode is designed to mimic the control algorithm of the early day thermal cyclers.
 - ii. **Sample Mode:** Enables system operation with simulated temperature control. Users are required to input the sample volume: 5-100 μl . In this mode, the temperature control algorithm will estimate the sample temperature based on the block temperature and the sample volume. This is recommended for normal operation.

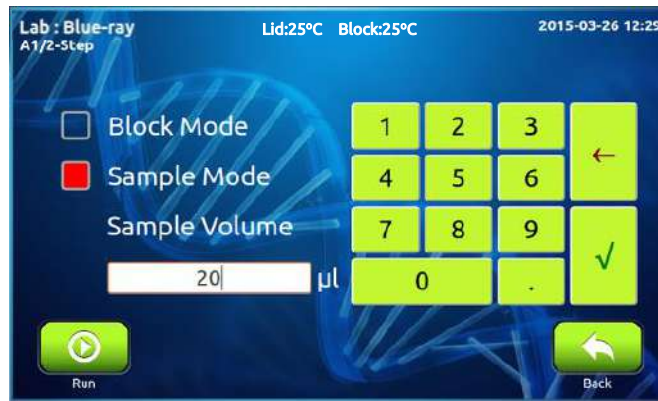

Figure 16. Sample block control mode

Tap on **Run** icon  to start the run.

6.2 Monitoring the Protocol Running Status

During the protocol running, the running status screen will be displayed as shown in Figure 17 below. The running **Step** is highlighted in red (heating) or blue (cooling).

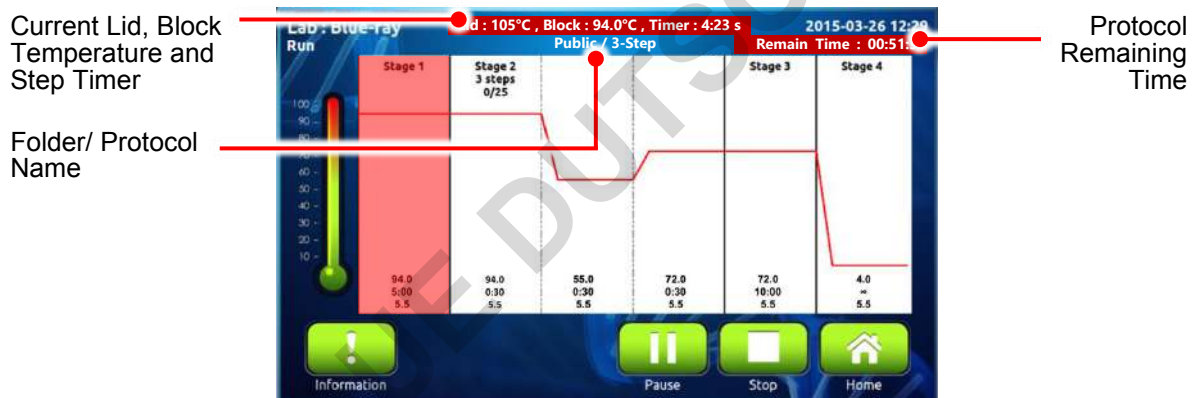

Figure 17. Running protocol





Tap on the **Information** icon  for more information as shown in Figure 18 below.





Figure 18. Run information

You can use the **Home** icon  to go to the **Main Screen** for other operation. To return to the running protocol, tap on the **Run Status** icon  on the **Main Screen**.



6.3 Pausing a Running Protocol

To pause a running **Protocol**, tap on the **Pause** icon , a dialog box will pop up, requesting you to confirm the operation. The protocol running will not be interrupted before your confirmation. Tap on  to confirm and start the pause. Tap on  to abort the operation.

During the pause period, the temperature of the lid heater and the sample block will be kept and the countdown timer of the **Step** will be paused. The **Pause** icon will be converted to the **Resume** icon .

To resume the paused protocol, tap on .

6.4 Terminating a Running Protocol

To stop a running **Protocol**, tap on the **Stop** icon , a dialog box will pop up, requesting you to confirm the operation. The protocol running will not be interrupted before your confirmation. Tap on  to confirm and stop the run. Tap on  to abort the operation.

7. Tools

Tap on the **Tools** icon  on the **Main Screen** to enter the **Tools** section as shown in Figure 19 below. 5 built-in tools are designed to assist you for your routine tasks.



Figure 19. Tools overview

7.1 Tm Calculator

Calculate the Tm, length, GC% and the molecular weight for the input primer.

7.2 Incubator

Allows you to use **TurboCycler 2** as an incubator.

7.3 Copy Number Converter

Convert the DNA concentration into copy number.

7.4 Mastermix Preparation Wizard

Calculate the volume of the reagents needed to make the mastermix.

7.5 Help

Display the quick operation guide for **TurboCycler 2**.

8. System Setup

Tap on the **System** icon  on the **Main Screen** to enter the **System** setup section as shown in Figure 20 below. Here you can adjust several parameters for the **TurboCycler 2**.

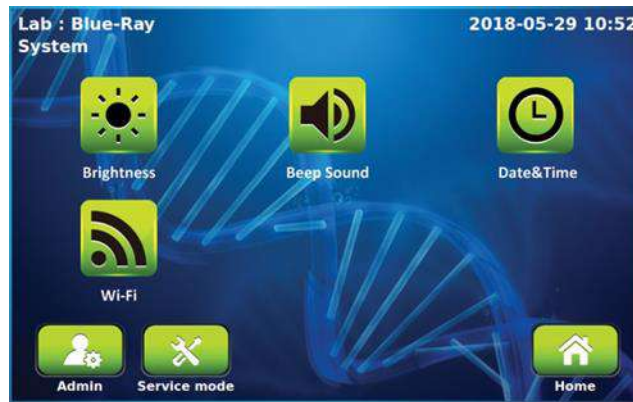

Figure 20. System overview

8.1 Brightness

You can change the brightness of the display panel according to your environment's lighting condition.

8.2 Beep Sound

You can turn **ON** or **OFF** the beep sound from here.

8.3 Date & Time

Users can change the date and time of the **TurboCycler 2** from here.

8.4 Wi-Fi

The setting for the optional **Wi-Fi module** can be done from here. Please refer to **Appendix C. Wi-Fi** for detailed instructions.

8.5 Administration

The default password of Administrator is "1111". The Administrator of this unit has rights to delete any **User Folder** and any **Protocols** inside a **User Folder**. You can change the Administrator password and the Lab Name from here.

8.6 Service Mode

Only authorized service personnel have the password to enter Service Mode and perform necessary maintenance and repairs

9. Maintenance

9.1 Cleaning the Unit

Please ensure that no liquid is spilled onto or into the unit. In addition, periodically wipe it, clean of dust, and other residue that comes with normal operation of the unit. Use a soft, lint-free cloth and deionized water. Air vents should be vacuumed to remove dust.

9.2 Cleaning the Heated Lid

Make sure the **TurboCycler 2** is turned off, unplugged and cooled down. Use mild detergents to clean material from the lid. A Kimwipe™ dipped in 70% ethanol will help remove residue from the sealing tape. Make sure the lid is dry prior to plugging in the power cable.

9.3 Replacing a Fuse

The fuse is located in the power socket module, just below the power connector. If the unit does not turn on when the power switch is turned on, you may need to check and replace the fuse.

To replace the fuse:

1. Disconnect the power cord from the unit.
2. Remove the fuse drawer with a small-blade screwdriver.
3. Pull the fuse out of the fuse socket.
4. Reinsert the new fuse into the fuse socket. Reinsert the fuse drawer.

10. Troubleshooting

Problem	Cause	Action
During the protocol running, the running status screen show warning icon 	Operating temperature environment may be unsuitable.	Operate the unit in a temperature environment between 15 to 30°C.
The display is off even when power is switched on.	Power is not reaching the system.	Check power source voltage.
	Power cord is not plugged into the socket properly.	Reconnect the power cord.
	Power fuse is blown out.	Replace the power fuse.
	Block fuse is blown out.	Return the unit for service.
	Panel is out of function.	Return the unit for service.
Can't reach 4°C.	Operating temperature environment may be unsuitable.	Operate the unit in a temperature environment between 15 to 30°C.
	Electronic cooling element may be damaged or aged.	Return the unit for service.
Cycle time is too long.	Operating environment temperature may be unsuitable.	Operate the system in a temperature environment between 15 to 30°C.
	Electronic cooling element may be damaged or aged.	Return the unit for service.
	Faulty temperature sensor.	Return the unit for service.
Lid heater does not work.	Lid heater is set to off.	Check Lid Temperature setting in System Mode.
	Lid sensor problem.	Return the unit for service.
No beep sound when tapping icons.	Sound may currently be set to off.	Check Beeper setting in System Mode.
	Faulty touch panel.	Return the unit for service.
The display goes off.	Faulty backlight.	Return the unit for service.
	Faulty LCD panel	Return the unit for service.
Display is too dark or bright.	Display brightness is not adjusted properly.	Adjust Display Brightness Potentiometer.
Lid will not close.	Foreign object between lid heater and sample block.	Remove the foreign object or matter.
	Faulty lid lock mechanism.	Return the unit for service.
Error message appears.	Refer to list of error messages in Section 10.1 below.	Check the nature of the error and take the suggested actions.

10.1 Error Messages

Message	Cause	Action
Error 1: Ambient temperature too high!	The room temperature exceeds 30°C.	Cool down the room temperature. Reboot the unit
	There is no enough space in the front and rear of the device.	Keep the front and rear of the device at least 10cm from the wall or other devices. Reboot the unit.
	The air vent is blocked.	Remove any objects blocking the vents. Reboot the unit.
Error 2: Ambient temperature sensor error!	Room temperature sensor problem.	Reboot the unit.
Error 3: Heat sink temperature too high!	The room temperature exceeds 30°C.	Cool down the room temperature. Reboot the unit.
	There is no enough space in the front and rear of the device.	Keep the front and rear of the device at least 10cm from the wall or other devices.
	The air vent is blocked.	Remove any objects blocking the vents. Reboot the unit.
Error 4: Heat sink temperature sensor error!	Heat sink temperature sensor problem.	Reboot the unit.
Error 5: Lid heater temperature too high!	Lid temperature exceeds 132°C.	Reboot the unit.
Error 6: Lid heater temperature sensor error!	Lid temperature sensor problem.	Reboot the unit.
Error 7: Lid heater cannot reach setting Temp.!	The room temperature is lower than 15°C.	Warm up the room temperature. Reboot the unit.
	Lid heater problem.	Reboot the unit.
Error 8~13: Block N (XX) temperature too high! N= 1 (UL) : upper left 2 (UC) : upper center 3 (UR) : upper right 4 (LL) : lower left 5 (LC) : lower center 6 (LR) : lower right	Block temperature exceeds 108°C.	Reboot the unit.

<p>Error 14~19: Block N (XX) temperature sensor error! N= 1 (UL) : upper left 2 (UC) : upper center 3 (UR) : upper right 4 (LL) : lower left 5 (LC) : lower center 6 (LR) : lower right</p>	<p>Block temperature sensor problem.</p>	<p>Reboot the unit.</p>
<p>Error 20~25: Block N (XX) cannot reach setting Temp.! N= 1 (UL) : upper left 2 (UC) : upper center 3 (UR) : upper right 4 (LL) : lower left 5 (LC) : lower center 6 (LR) : lower right</p>	<p>The room temperature is lower than 15°C or exceeds 30°C.</p>	<p>Maintain the room temperature at 15~30°C range. Reboot the unit.</p>
<p>Error 26~31: Block N (XX) cannot hold at setting Temp.! N= 1 (UL) : upper left 2 (UC) : upper center 3 (UR) : upper right 4 (LL) : lower left 5 (LC) : lower center 6 (LR) : lower right</p>	<p>Block thermoelectric module problem.</p>	<p>Reboot the unit.</p>
<p>Error32: TEXT_UART_NO_ANSWER</p>		<p>Reboot the unit.</p>
<p>Error 33: TEXT_UART_RECEIVE_WRONG</p>		<p>Reboot the unit.</p>

If the same error message appears after rebooting the unit, please return the unit for service.

Appendix A: Technical Specifications

Sample Block	
96 well, gradient block	Compatible with regular profile or low profile 0.1 ml PCR tube, strip, non-skirted, semi-skirted and full skirted 96-well plate
Block Temperature	
Block Temperature range	4.0 to 100°C
Maximum Heating/Cooling Rate	5.5/3.3°C/sec
Average Heating/Cooling Rate	4.1/2.4°C/sec
Accuracy	+/-0.3°C
Uniformity	+/-0.3°C
Adjustable Ramping rates	Yes, 0.1 - 5.5°C/sec
Gradient Temperature	
Gradient direction:	Horizontal across the block
Gradient Temperature Range	30 ~ 100°C
Gradient Temperature Difference	Max. span 30°C
Software	
Portability of protocols	Save and transfer to another TurboCycler 2 via USB flash drive
Stored program no.	> 4000 sets
Registered user folder no.	100 sets
User folder password protection	Yes
Run status report	Yes, HTML output and transfer via USB flash drive
Real-time Temp. profile export	Yes, CSV output and transfer via USB flash drive
Tools	TM calculator, Copy number calculator, Mastermix preparation calculator
General	
Display	7" color LCD with capacitive touch panel
Data Ports	1 USB A front port for USB flash drive
Heated Lid	35 - 120°C or off
Auto restart after power outage	Yes
Remote motoring	With optional Wi-Fi module
Footprint Dimensions (H x W x D)	225 mm x 245 mm x 415 mm
Weight	9.5 kg
Power Supply	VAC 100-240, 50/60 Hz, 750 W
Standard	CE, RoHS

Appendix B: Template Protocols

2-Step

Stage 1	94°C, 5 min
Stage 2	94°C, 30 sec
30 cycles	67°C, 30 sec
Stage 3	72°C, 7 min
Stage 4	4°C, Hold

3-Step

Stage 1	94°C, 5 min
Stage 2	94°C, 30 sec
30 cycles	55°C, 30 sec
	72°C, 30 sec
Stage 3	72°C, 7 min
Stage 4	4°C, Hold

Gradient

Stage 1	94°C, 5 min
Stage 2	94°C, 30 sec
30 cycles	Gradient 55~70°C, 30 sec
	72°C, 30 sec
Stage 3	72°C, 7 min
Stage 4	4°C, Hold

Time Increment

Stage 1	94°C, 5 min
Stage 2	94°C, 30 sec
30 cycles	65°C, 30 sec (+1sec/Cycle)
	72°C, 30 sec
Stage 3	72°C, 7 min
Stage 4	4°C, Hold

Touch down

Stage 1	94°C, 5 min
Stage 2 30 cycles	94°C, 30 sec
	60°C (-0.5°C/Cycle), 30 sec
	72°C, 30 sec
Stage 3 30 cycles	94°C, 30 sec
	45°C, 30 sec
	72°C, 30 sec
Stage 4	72°C, 7 min
Stage 5	4°C, Hold

DOMINIQUE DUTSCHER SAS

Appendix C: Wi-Fi

I. Configure the Wi-Fi Module

Tap on the **Wi-Fi** icon  on the **System** screen to enter the Wi-Fi module configuration screen (see Figure C1 below).

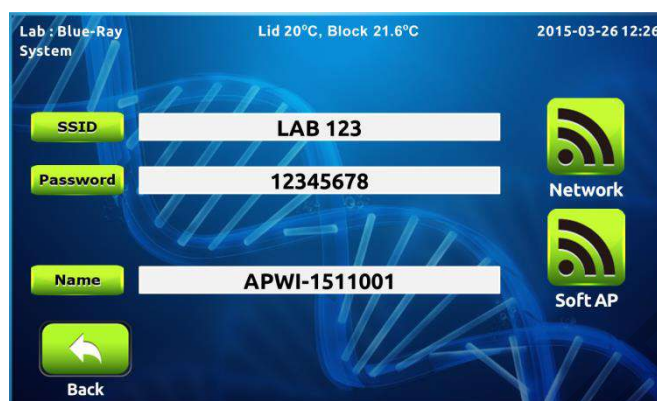





Figure C1. Wi-Fi module configuration screen

Please make sure that the name displayed here matches to the listed name on the QR code label on the back of the instrument. If the name does not match, please tap on **Name** to modify it.

If there is any available WLAN in the nearby area, please tap on **SSID** and **Password** to enter the correct SSID and password and tap on the **Network** icon  to connect the **TurboCycler 2** to the WLAN. If there isn't any WLAN available in the nearby area, please leave the SSID and password box empty and tap on the **Soft AP** icon  to set the **TurboCycler 2** as a WLAN access point. Tap on the **Back** icon  to exit the Wi-Fi module configuration screen.

II. Install the TurboApp for the Mobile Device



Please visit the following link to download the TurboApp for your mobile device.



For Android device:

<https://play.google.com/store/apps/details?id=com.laij002.turbo>.

For iOS device:

<https://itunes.apple.com/tw/app/turboapp/id1057459073>.

III. Configure the TurboApp

Make sure the WLAN function of your mobile device is enabled. Tap on the **TurboApp**  to launch the app. Tap on the **Option** icon  to enter the configuration screen (see Figure C2 left and right).

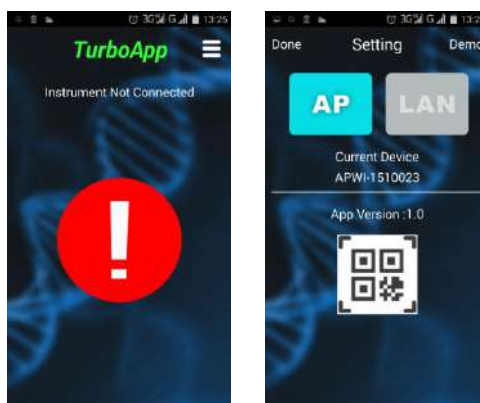



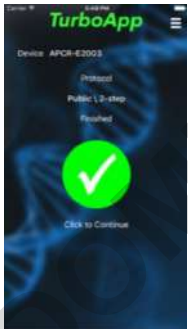



Figure C2. TurboApp main screen (Left) and configuration screen (right)

Tap on the **QR code** icon  and scan the QR code label on the back of the **TurboCycler 2** you want to monitor, **TurboApp** will then register the device name. If the **TurboCycler 2** is set to Network mode, please make sure your mobile device is connected to the same WLAN access point and tap on **LAN**. If the **TurboCycler 2** is set to Soft AP mode, please tap on **AP**. Tap on **Done** to exit the configuration screen.

IV. TurboApp Status Screen

	<p>TurboCycler 2 is ready.</p>		<p>The protocol is running.</p>
	<p>The protocol is finished. There will be an audio alarm to remind the user.</p>		<p>The protocol is holding for incubation. There will be an audio alarm to remind the user.</p>
	<p>There is no registered device, or registered TurboCycler 2 is off-line.</p>		

Appendix D: CE Declaration



BLUE-RAY BIOTECH CORP.

5F., No.2, Aly.2, Siwei Ln., Zhongzheng
Rd., Xindian Dist., New Taipei City
23148, Taiwan (R.O.C.)

Declaration of Conformity

Product Name: TurboCycler 2

Model Names: TCST-9612 / TCST-9622

All models comply with the following European standards:

EMC: EN 61326-1

Safety: EN 61010-1 and EN 61010-2-010

To the best of my knowledge and belief, these units conform to these standards.

Name: Jeremy Lai

Position: Quality Assurance Manager

Issue Date: 2015. 10. 4

Appendix E: Order Information

TCST-9612/TCST-9622	Gradient TurboCycler 2 with 96-well sample block (110V/230V)
TCST-a001	Wi-Fi Upgrade Module
TCST-a002	5.2 mm Compression mat x 10
TCST-a003	1.0 mm Compression mat x 10

DOMINIQUE DUTSCHER SAS

DOMINIQUE DUTSCHER SAS

DOMINIQUE DUTSCHER SAS

Blue-Ray Biotech Corp.

5F., No.2, Aly.2, Siwei Ln., Zhongzheng Rd., Xindian Dist., New Taipei City 23148, Taiwan (R.O.C.)

www.blue-raybio.com

P/N: 401-TCBR01-22