

Thermo Scientific Wellwash Versa

User Manual

Rev. 1.3



DOMINIQUE DUTSCHER SAS

Thermo Scientific
Wellwash Versa
User Manual

Rev. 1.3, Cat. No. N11166

DOMINIQUE DUTSCHER SAS

Copyright

© 2014 Thermo Fisher Scientific Inc. First edition published in 2010. All rights reserved. Decon is a trademark of Decon Laboratories Limited. Microside SQ is a trademark of Global Biotechnologies, Inc. Virkon is a trademark of E.I. du Pont de Nemours and Company or its affiliates. All (other) trademarks are the sole property of Thermo Fisher Scientific Inc. and its subsidiaries.

Reproduction of the accompanying user documentation in whole or in part is prohibited.

Disclaimer

Thermo Fisher Scientific reserves the right to change its products and services at any time to incorporate technological developments. This manual is subject to change without prior notice as part of continuous product development. Although this manual has been prepared with every precaution to ensure accuracy, Thermo Fisher Scientific assumes no liability for any errors or omissions, nor for any damages resulting from the application or use of this information. This manual supersedes all previous editions.

Remarks on screenshots and pictures

The version number displayed in screenshots may not always be the one of the currently released version. Screenshots and pictures are only replaced if the content related to the application has changed.

No liability for consequential damages

Thermo Fisher Scientific shall not be liable for any direct or consequential damages whatsoever arising out of the use or inability to use this product.

Power failure

The system requires uninterrupted power supply in order to operate correctly. Thermo Fisher Scientific has no responsibility whatsoever for system malfunctions arising from power failures.

Cat. No. N11166

February 2014

Manufacturer

Thermo Fisher Scientific Oy
Ratastie 2, P.O. Box 100
FI-01621 Vantaa
Finland

About This User Manual

Intended users

The Thermo Scientific™ Wellwash™ Versa microplate washer can be used as standalone in research and routine-test laboratories by professional personnel.

How to use this user manual

This user manual is for the following instruments, Wellwash Versa: Cat. No. 5165010 and 5165050. It has been written to give you the information you need to:

- Review safety precautions
- Install the Wellwash Versa
- Navigate and edit in the Wellwash Versa user interface
- Operate the instrument
- Create and run wash protocols
- Define wash parameters
- Perform cleaning and maintenance procedures
- Troubleshoot the instrument performance

This user manual also describes all the features and specifications of the Wellwash Versa instrument as well as ordering information.

Read the manual in its entirety before operating the instrument.

Keep the user manual on the CD provided for future reference. The user manual is an important part of the instrument and should be readily available during use of the instrument. Keep the user manual together with the instrument in case you distribute it onwards.

For more information

For the latest information on products and services, visit our websites at:

<http://www.thermoscientific.com>

<http://www.thermoscientific.com/wellwash>

<http://www.unitylabservices.com>

In an effort to provide useful and appropriate documentation, we appreciate any comments you may have on this user manual for your local Thermo Fisher Scientific representative.

Safety symbols and markings

These symbols are intended to draw your attention to particularly important information and alert you to the presence of hazards as indicated.

Safety symbols and markings used on the Wellwash Versa

The following symbols and markings appear on the type label and the instrument itself.



Power ON ▲

Power OFF ▲

Serial number ▲

Catalog number ▲

Date of manufacture ▲

Consult instructions for use ▲

WEEE symbol This product is required to comply with the European Union's Waste Electrical & Electronic Equipment (WEEE) Directive 2012/19/EC. ▲

Warning and other markings used in the documentation

The following symbols and markings appear in this user manual.



Warning Risk of electric shock. ▲



Warning Biohazard risk. ▲



Warning Risk of injury to the user(s). ▲



Caution Risk of damage to the instrument, other equipment or loss of performance or function in a specific application. ▲



Note Marks a hint, important information that is useful in the optimum operation of the system, or an item of interest. ▲

DOMINIQUE DUTSCHER SAS

DOMINIQUE DUTSCHER SAS

Contents

	Intended users	3
	How to use this user manual	3
	For more information	3
	Safety symbols and markings	4
	Safety symbols and markings used on the Wellwash Versa	4
	Warning and other markings used in the documentation	5
Chapter 1	Introduction to the Wellwash Versa Microplate Washer	11
	Intended use.....	12
	Principle of operation.....	12
Chapter 2	Installation	15
	What to do upon delivery	15
	How to unpack	15
	Checking delivery for completeness or damage.....	15
	Environmental requirements	16
	Setups	16
	Releasing the transport lock.....	16
	Installing the priming vessel	17
	Installing the wash head(s)	18
	Installing the cell wash head	21
	Liquid bottles and channels.....	22
	Connection diagram.....	23
	Installing the liquid bottles.....	24
	Foaming.....	27
	Connecting the power supply cable	27
	Connecting to a computer.....	28
	Warnings and cautions.....	28
	Electrical	28
	Defects and abnormal stresses.....	29
	Operating precautions and limitations before operation	29
	Mechanical checks before switching on	30
	Installing the aerosol cover	31
	Switching on	31
	Performing the operational check after switching on	31
	Settings after installation	32
Chapter 3	Wellwash Versa Main Parts.....	33
	Instrument views.....	33
	Liquid system diagram	35
	USB memory device port	35
	USB PC port.....	35
	Plate carrier	35

	Wash heads	36
	Shaker	37
Chapter 4	Operating the Instrument.....	39
	Display and keys for navigating and editing	39
	Menus.....	41
	Main menu	41
	Liquid level detection	42
Chapter 5	Running Protocols.....	43
	Filling and emptying liquid bottles.....	44
	Starting ready-made protocols	44
	Starting a ready-made protocol with the quick keys.....	45
	Starting a ready-made protocol from the list.....	45
	Loading the plate	46
	Priming the system.....	47
	Strip selection.....	48
	Strip selection with the number keys.....	49
	Strip selection with the Layout row.....	50
	Starting a run	51
	Canceling a run.....	51
	Rinsing the liquid system	51
Chapter 6	Menus, Tabs and Parameters	53
	Display and keys for navigating and editing	53
	Menus.....	55
	Main menu	55
	Liquid level detection	56
	Protocol	56
	Creating a protocol	57
	Creating a protocol in an optional way.....	60
	Adding new steps to protocols.....	61
	Deleting steps from protocols.....	63
	Head / Plate	63
	Well	64
	Microplate requirements	66
	Steps	66
	Wash.....	67
	Cell wash.....	71
	Aspirate.....	74
	Cell aspirate	75
	Dispense	76
	Cell dispense	77
	Soak.....	78
	Prime	79
	Pause.....	80
	Layout.....	80
	Settings menu	81

	Prime & rinse parameters	81
	Sensors	83
	Wash head configuration.....	84
	System.....	85
	Reports.....	86
	Maintenance menu	87
	Clean	87
	Cleaning/Disinfection procedure.....	87
	Clean wash head.....	90
	Soak wash head	92
	Move wash head.....	93
	Empty priming vessel	94
	Calibration	95
	Starting the calibration	96
	Active calibration	97
	Calibrate current wash head	97
	Service.....	102
Chapter 7	Exporting and Importing	103
	Exporting a protocol	103
	Importing a protocol.....	104
	Exporting a protocol as text file.....	105
Chapter 8	Deleting.....	107
	Deleting a protocol	107
Chapter 9	Shutdown.....	109
	Shutting down	109
Chapter 10	Emergency Situations	111
	Handling abnormal situations	111
	Regular and preventative maintenance	113
Chapter 11	Maintenance.....	113
	Maintenance checklist.....	113
	Instrument care	114
	Cleaning the instrument.....	115
	Salt deposit.....	115
	Cleaning the priming vessel.....	115
	Cleaning the plate carrier	116
	Cleaning liquid bottles	117
	Checking the liquid level sensors.....	118
	Autoclavation	118
	Cleaning the wash head(s).....	119
	Mechanical cleaning of the wash head	119
	Changing or replacing the wash head	120
	Checking the liquid line.....	120
	Checking the residual volume	120

	Checking the dispense accuracy.....	121
	Checking the aspirate height	121
	Manual priming	121
	Disposal of materials	122
	Decontamination procedure.....	122
	Refitting the transport lock	124
	Maintaining a system log.....	125
	How to pack for service.....	125
	Disposal of the instrument	126
Chapter 12	Technical Specifications	129
	General specifications.....	129
	Performance specifications	130
	Safety specifications.....	131
	In conformity with the requirements.....	131
Chapter 13	Troubleshooting Guide.....	133
	Error and warning codes	133
	USB memory device.....	134
	Troubleshooting guide	135
Chapter 14	Ordering Information	137
	Wellwash Versa.....	137
	List of spare parts and accessories	137
Appendix A	System Log.....	139
Appendix B	Certificate of Decontamination	141

Chapter 1

Introduction to the Wellwash Versa Microplate Washer

The Wellwash Versa (Figure 1-1) is a microplate washer. It is designed to use both 96- and 384-well plate formats: the 96-well plate in both *landscape* and *portrait* orientation, and the 384-well plate in *landscape* orientation. The 96-well plates and strips are designed to be washed in 1x8, 2x8, 1x12, or 2x12 format, and the 384-well plates in 1x16 format. Additionally, a 2x8 cell wash head is available for washing of cells in 96-well plates. The instrument allows shaking. The instrument is controlled through the built-in graphical user interface and keypad. In addition, the Wellwash Versa can be connected to plate handling devices.

The Wellwash Versa can be used to wash and prepare plates for a variety of test routines, mainly in enzyme-linked immunosorbent assay (ELISA) tests.

The Wellwash Versa is available in the following configurations:

- Wellwash Versa 2x8 100-240V (Cat. No. 5165010)
 - 96- and 384-well plate washing
- Wellwash Versa 2x12 100-240V Cat. No. 5165050)
 - 96- and 384-well plate washing



Figure 1-1. Wellwash Versa microplate washer

Intended use

The Wellwash Versa is a microplate washer intended for automated washing, aspiration, dispensing, and shaking of 96- and 384-well plates and strips that meet ANSI/SBS standards. The instrument can be equipped with up to four liquid bottles. It can be used in research or routine-test laboratories by professional personnel.

As the Wellwash Versa is part of an analyzing system for the end user, the user is responsible for validation of the whole system to enable production of reliable and safe results. If the assay performance is essential to the analysis, the test result has to be assured using internal quality controls or an alternative test.

It is recommended using Good Laboratory Practice (GLP) during the analyzing process.

Use for self-testing is excluded.

Principle of operation

The Wellwash Versa can be used to wash and prepare plates for a variety of test routines, mainly in ELISA applications. The Wellwash Versa (Figure 1-1) is a microplate strip washer for automated washing, aspiration, dispensing, and shaking of both 96- and 384-well plate formats: the 96-well plate in both *landscape* and *portrait* orientation, and the 384-well plate in *landscape* orientation. The instrument is equipped with three standard buffer bottles and one waste liquid bottle each with a cap, tubing, and a liquid level sensor. The instrument has a color display with an intuitive graphical user interface and keypad for programming and controlling the instrument. The Wellwash Versa comes with a 1x8, 2x8, 1x12, or 2x12 wash head. The plate carrier places the microplate accurately under the wash head to perform the desired operation. During priming the wash head moves into the priming vessel to fill the liquid tubing from the liquid bottle to the wash head tips.

The 96-well plates and strips are designed to be washed in 1x8, 2x8, 1x12, or 2x12 format, and the 384-well plates in 1x16 format (Figure 1-2). Additionally, a 2x8 cell wash head is available for washing of cells in 96-well plates. The wash heads have both dispensing and aspiration channels. In the washing step, the wash heads aspirate continuously and descend until they reach the bottom of the well and the liquid is aspirated (Figure 1-3). In sweep mode, the wash heads aspirate in two positions of the well bottom to enable a low residual volume (Figure 1-4). When the wash heads are in the upper position, the desired volume is dispensed into the well (Figure 1-3 and Figure 1-4). Aspiration runs continuously, enabling overflow dispensing of large volumes. After the first row or column has been washed, the next row or column is moved under the wash heads for washing.



Figure 1-2. Wash heads



Figure 1-3. Principle of washing step (Normal)

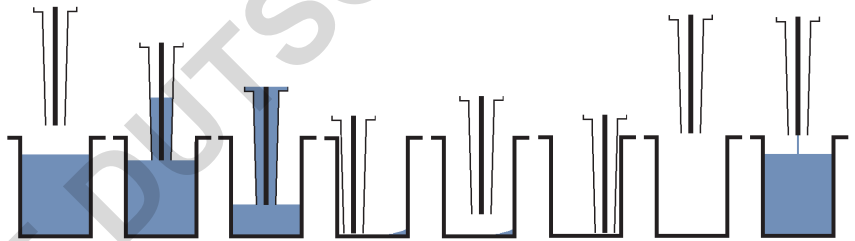

Figure 1-4. Principle of washing step (Sweep2)



Figure 1-5. Principle of washing step (Sweep3)

Introduction to the Wellwash Versa Microplate Washer

Principle of operation

DOMINIQUE DUTSCHER SAS

Chapter 2

Installation



Warning The Wellwash Versa weighs 9 kg [19.8 lbs.] and care must be taken when lifting the instrument. ▲

For more information on main parts of the instrument, refer to Chapter 3: “*Wellwash Versa Main Parts*”.

What to do upon delivery

This section covers the relevant procedures to be carried out on receipt of the instrument.

How to unpack

Move the packed instrument to its site of operation. To prevent condensation, the instrument should be left in its protective plastic wrapping until the ambient temperature has been reached. Unpack the Wellwash Versa instrument and accessories carefully with the arrows on the transport package pointing upwards. Place the instrument onto a laboratory bench.



Caution Do not touch or loosen any screws or parts other than those specifically designated in the instructions. Doing so may cause misalignment and will invalidate the instrument warranty. ▲

Retain the original packaging for future transportation. The packaging is designed to assure safe transport and minimize transit damage. Using other packaging materials may invalidate the warranty. Also retain all instrument-related documentation provided by the manufacturer for future use.

If you relocate your instrument or ship it for service, refer to “How to pack for service” on page 125.

Checking delivery for completeness or damage

Check the enclosed packing list against the order. Visually inspect the transport package, the instrument and the accessories for any possible transport damage. If any parts are missing or damaged, contact your local Thermo Fisher Scientific representative or Thermo Fisher Scientific Oy.



Caution If the instrument has been mechanically damaged, ship it for service. ▲

Environmental requirements

When you set up your Wellwash Versa, avoid sites with excess dust, vibrations, strong magnetic fields, direct sunlight, draft, excessive moisture, or large temperature fluctuations. Make sure that:

- The working area is flat, dry, clean and vibration-proof, and leave additional room for cables, covers, and so on.
- There is at least 10 cm around the instrument on the laboratory bench of free space for ventilation.
- There is sufficient room behind the instrument to enable disconnecting the device.
- The ambient air is clean and free of corrosive vapors, smoke, and dust.
- The ambient temperature range is between +10°C (50°F) and +40°C (104°F).
- The humidity is low so that condensation does not occur (relative humidity is between 10% and 80%, non-condensing).



Caution Do not operate the instrument in an environment where potentially damaging liquids or gases are present. ▲

Setups

This section describes the procedures that must be carried out before instrument operation.



Warning All parts of the instrument that come into contact with potentially infectious materials must be treated as potentially infectious areas.

It is advisable to adhere to applicable safety precautions, such as the wearing of disposable powder-free gloves, safety glasses, and protective clothing, to avoid potential infectious disease contamination when performing cleaning procedures and also when making adjustments to the instrument. ▲



Caution Leave the instrument to stand for at least three hours before installing and switching it on, so there is no possibility of condensation causing a short circuit. ▲

Releasing the transport lock



The instrument comes with one transport lock.

Caution Make sure that the transport lock has been removed and that the priming vessel, the wash heads, and the liquid bottles with tubes and liquid level detectors have been installed before you put the instrument into operation. ▲

1. Remove the padded packing material protecting the wash head arm and plate carrier to reveal the transport lock and transport lock tag (Figure 2–6). Also remove the plastic transport protection bag.



Figure 2–6. Transport lock and transport lock tag

2. Unfasten the transport lock screw with the Allen key supplied (Figure 2–7).

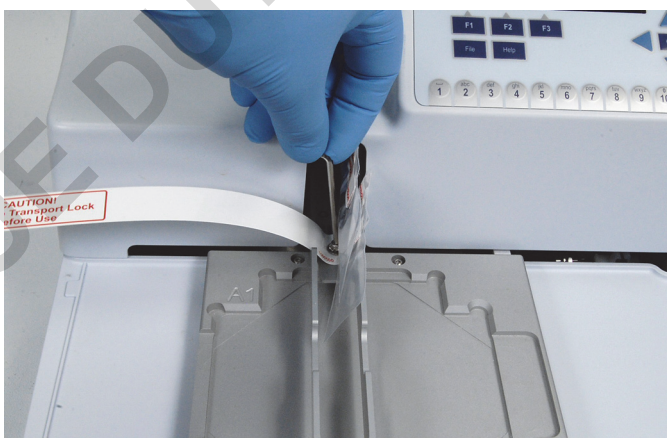

Figure 2–7. Unfastening the transport lock

3. Keep the transport lock and tag for future relocation or transportation of the instrument.

Installing the priming vessel

The instrument comes with the priming vessel installed. The priming vessel is correctly installed if it stays in place and does not move up. If the priming vessel is not installed, insert it downwards and pull it towards yourself (Figure 2–8).

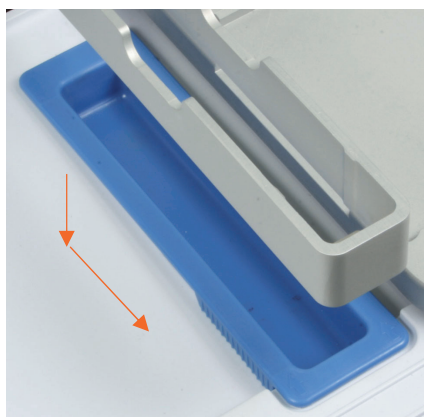

Figure 2–8. Priming vessel installation



Warning The priming vessel may be contaminated after the instrument has been used. ▲

Installing the wash head(s)

The wash heads are packed separately and must be installed before use. Keep the wash head package for storage purposes. If the wash head is not used, place it first into the enclosed plastic bag and then into the original package. The wash heads supplied with the instrument are calibrated at the factory. The wash head box includes an instrument serial number according to which it has been calibrated at the factory. Optional wash heads should be calibrated by the user prior to use.



Warning The wash heads may be contaminated after the instrument has been used. ▲



Warning Failing to connect the dispensing or aspiration tube may cause spillage. ▲



Caution Only use wash heads that have an identification label. ▲



Note Always wear disposable powder-free gloves when handling the wash heads. ▲



Note Do not remove the lot number sticker on the wash head. ▲

1. The instrument is supplied with a 1x8, 2x8, 1x12, or 2x12 wash head.
2. Fit the supplied wash heads to the tubing according to Figure 2–9 through Figure 2–11. Note the difference in sizes.
 - The larger aspiration (waste) tube is connected to the bottom hole.

- The smaller dispensing tube is connected to the top hole.
- Apply silicone grease to the O-rings of the tubes if needed.
- The small and large tubes on the left side are **blue** for easier recognition.

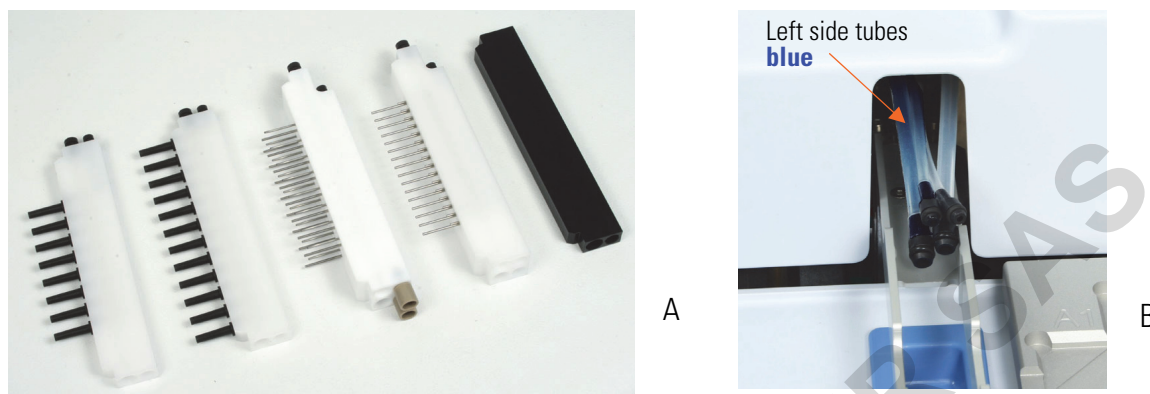

Figure 2–9. Optional wash heads (A) as well as aspiration and dispensing tubes (B). **Note:** four tubes: two **blue** tubes on the left-hand side and two **clear** tubes on the right-hand side.



Figure 2–10. Fitting the wash heads to the connectors

3. Fit the wash heads next to each other onto the wash head arm with the tips pointing downwards and ensure that the wash heads move freely up and down in the wash head arm slot (Figure 2–11).

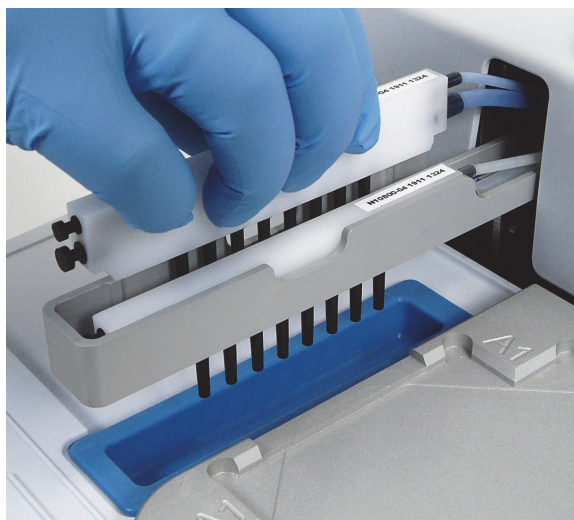

Figure 2–11. Fitting the 2x8 wash heads next to each other onto the wash head arm (A and B)

4. Check that the wash heads are evenly inserted (Figure 2–12).

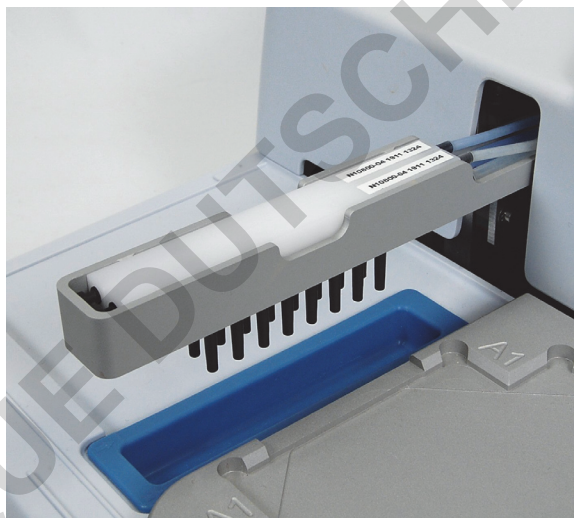

Figure 2–12. 2x8 wash heads evenly inserted

5. Ensure that the wash heads are in the correct order (Figure 2–13).
6. If only one wash head (1x8 or 1x12) is used, place the blank wash head onto the left position of the wash head arm.



Caution If you use the device with a blank wash head, the dry tubes will cause the pump to operate more loudly. It is recommended to prime both channels to reduce the noise. ▲



Figure 2–13. Fitting the blank wash head onto the left position of the wash head arm

7. If you replace the wash head, you must calibrate the wash head. Refer to “Calibrate current wash head” on page 97.
8. If you change the wash head to another type, first change the wash head and then calibrate the wash head.

Installing the cell wash head

Install the optional 2x8 / 96 (cell wash) wash head properly onto the wash head arm (Figure 2–14). Refer to “Installing the wash head(s)” on page 18.



Note Check that the brown adapters of the 2x8 cell wash head are inserted (Figure 2–14). ▲



Note When you replace the cell wash head adapters (Figure 2–14 A), change them both at the same time. ▲

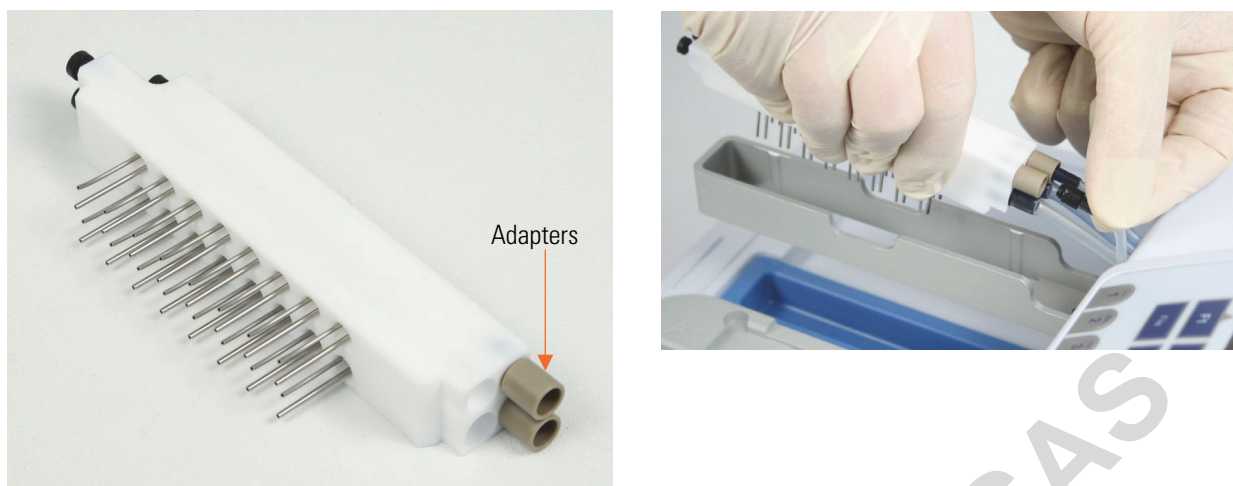

Figure 2–14. Installing the 2x8 cell wash head onto the wash head arm

Liquid bottles and channels

The Wellwash Versa includes three standard buffer bottles (2 liters) and the waste bottle (4 liters). Bottles for greater volumes are available as an option (4 l for buffers and 9 l for waste).

The liquid channels are: **A** (for Buffer A), **B** (for Buffer B), **R** (for Rinse), and **W** (for Waste). Channel R is primarily intended for rinsing and is connected to the **RINSE** button as the only channel. The Rinse channel can also be used in wash protocols as the buffer source. The rinse solution is normally deionized distilled water.

The liquid bottles are named and the tubing is color coded to correspond to the correct buffer source (**A** = blue, **B** = yellow, **R** = green, and **W** = colorless) (Figure 2–15). Refer to “Connection diagram” on page 23.

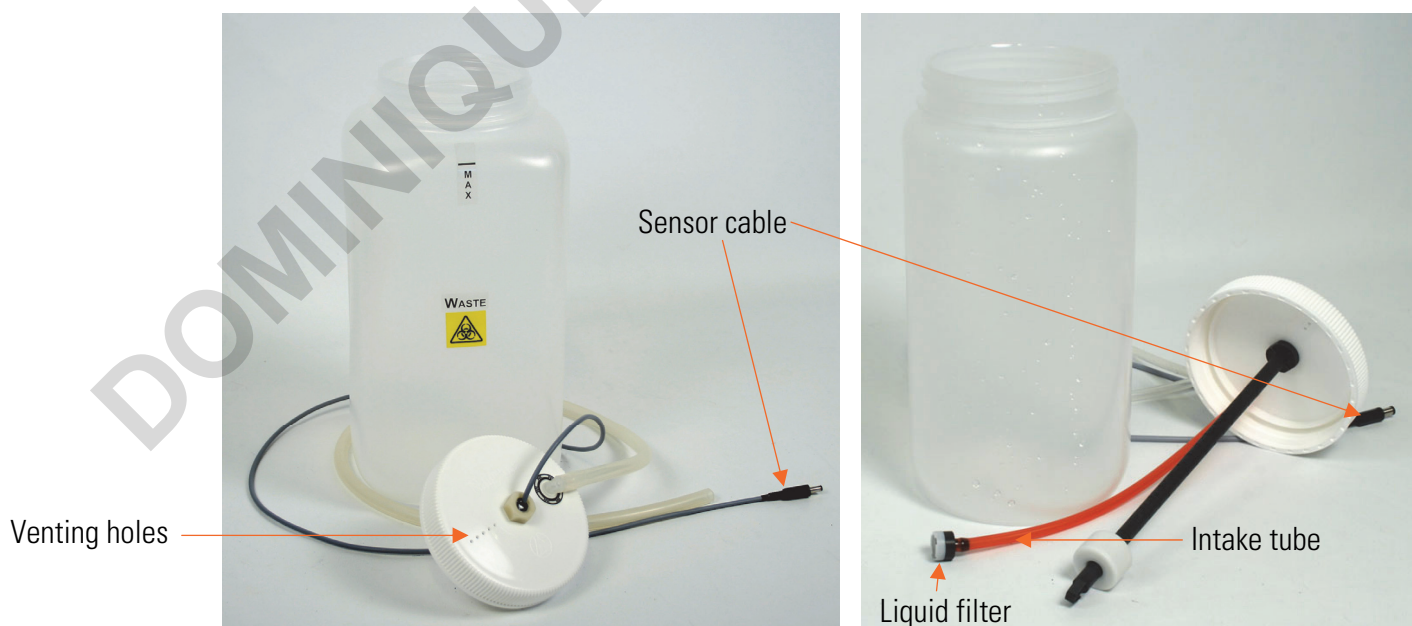

Figure 2–15. Waste and liquid bottles with liquid level sensors



Caution Do not cover the venting holes. ▲



Caution If foaming occurs in the waste bottle, refer to “Foaming” on page 27. ▲



Caution Do not limit, change or remove the float position on the liquid level sensor. ▲

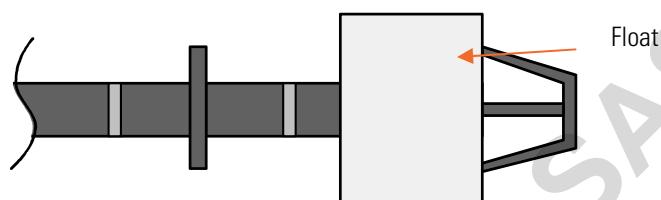

Figure 2–16. Correct position of the float on the buffer bottle sensor

Smaller bottles can also be used with an optional bottle holder (Cat. No. N10820).



Caution If a smaller size buffer bottle is used with the bottle stand, the remaining volume in the bottle after the liquid level sensor indicates empty may be smaller than the nominal 290 ml. ▲



Caution Before disconnecting the tubing, prime the liquid system with air to avoid liquid spillage. ▲

Connection diagram

Figure 2–17 shows the connections of the liquid level sensor cabling and liquid bottle tubing.

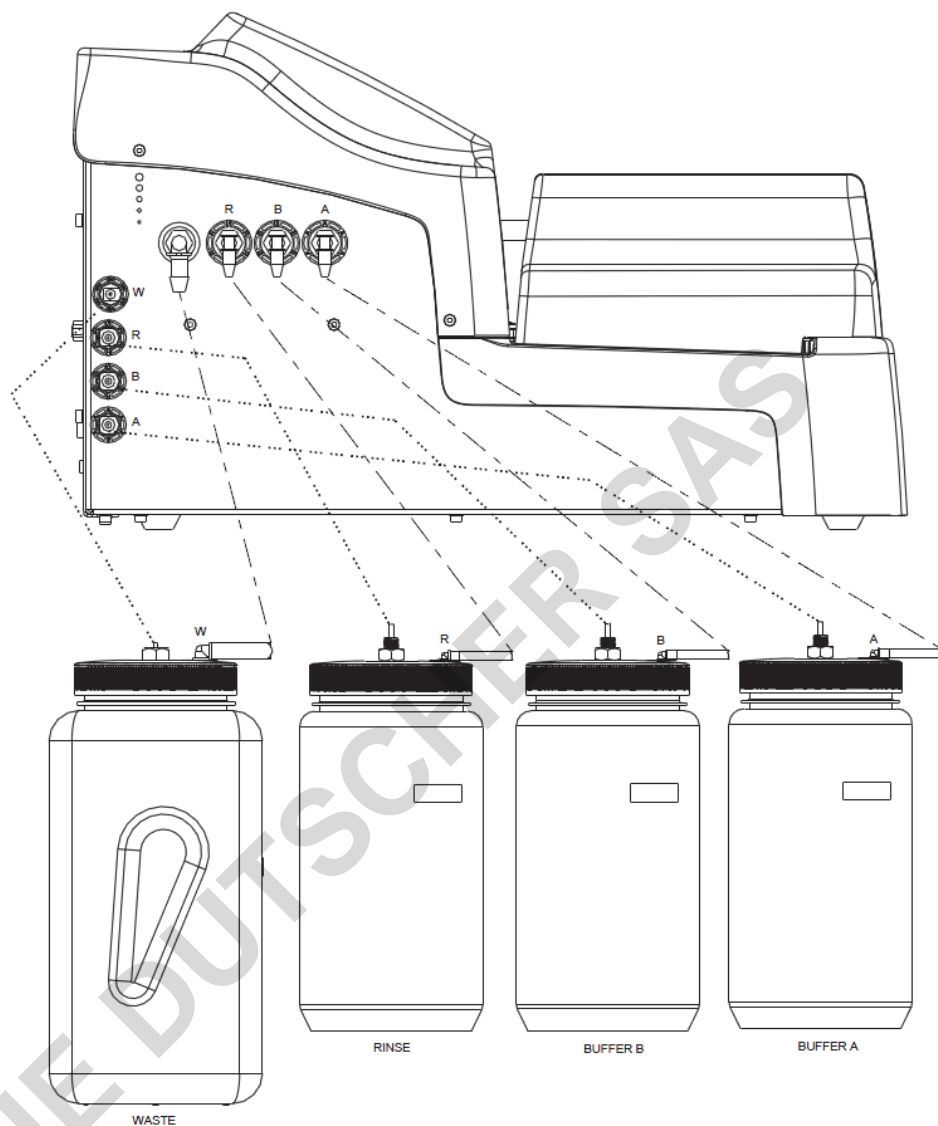

Figure 2-17. Wellwash Versa connection diagram

Installing the liquid bottles

1. Fit the liquid bottle tubing to the corresponding color-coded tube connectors on the left side panel of the instrument (Figure 2-18). The connectors are from left to right: **W** = colorless (Waste), **R** = green (Rinse), **B** = yellow (Buffer B), and **A** = blue (Buffer A).



Figure 2–18. Connecting the liquid bottle tubing

2. Connect the liquid sensor cables into the appropriate color-coded sockets on the left side panel of the instrument (Figure 2–19). The sockets are from top to bottom: **W** (Waste), **R** (Rinse), **B** (Buffer B), and **A** (Buffer A).



Figure 2–19. Connecting the liquid sensor cable

All the liquid bottles are connected to the instrument in Figure 2–20.

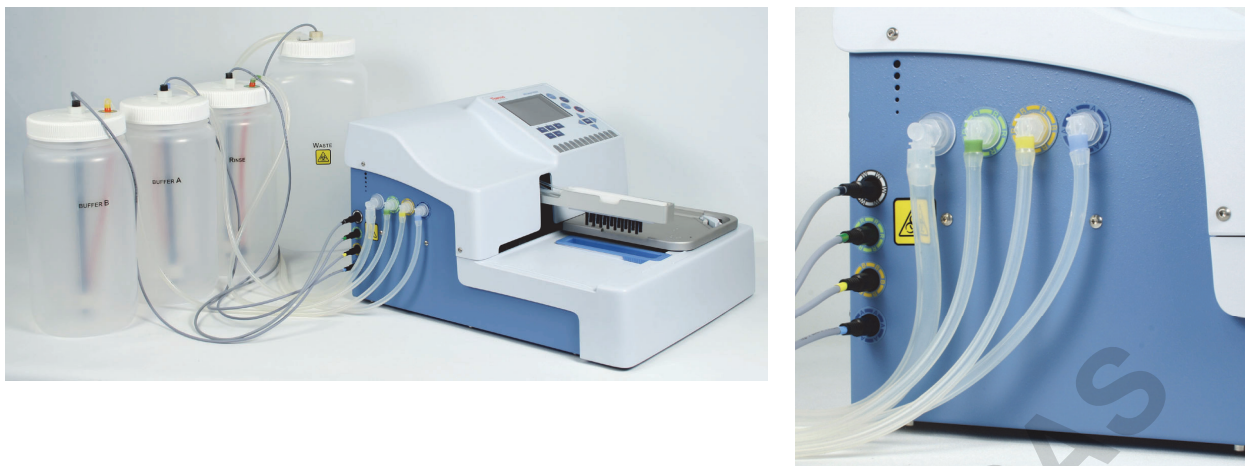

Figure 2–20. Liquid bottles connected to the instrument



Warning Make sure that the liquid level of the waste bottle is always kept below the maximum level indicated on the bottle to avoid potential overflow, as the contents of the waste bottle is potentially infectious. ▲



Warning The contents of the waste bottle is potentially infectious, so it is important to wear protective clothing, such as disposable gloves, a laboratory coat, and safety glasses, when emptying or handling the waste bottle. ▲



Caution Always ensure that the liquid bottles are attached properly. Always connect the bottle cap to the correct bottle and to the correct connector on the left side of the instrument. Otherwise the wash performance can be seriously affected. ▲



Caution Ensure that the intake tube reaches fully down to the bottom of the liquid bottle so that no red tubing is visible. ▲



Caution Check regularly that the liquid filters in the intake tubes are clean. If not, replace or clean them. ▲



Caution To ensure proper function, do not disconnect the sensor cables from the instrument during operation. ▲

Foaming The liquid level sensor is unable to detect foam. In case of foaming:

1. Empty the waste bottle as soon as the foam level has reached the maximum filling level indicated on the waste bottle.
2. Add a commercially available anti-foaming agent, such as silicone oil, to the empty waste bottle to reduce foaming. Use concentrations of anti-foaming agents as recommended by the manufacturers.
3. Consider switching to a larger waste bottle and additionally increasing the concentration of anti-foaming agent in the waste bottle.
4. Carefully swirl the waste bottle from time to time to improve mixing between the foam layer and anti-foaming agent.

Connecting the power supply cable



To connect the power supply cable:

Warning Do not operate your instrument from a power outlet that has no ground connection. Do not use a power supply cable other than the Thermo Scientific power supply cable designed for your region. ▲

1. Ensure that the mains (**I/O**) switch (Figure 2–21) at the right side panel of the instrument is in the off (**O**) position.
2. Connect the power supply cable to the power supply connector.
3. Connect the power supply to a correctly installed line power outlet with a grounded conductor.

Installation

Connecting to a computer

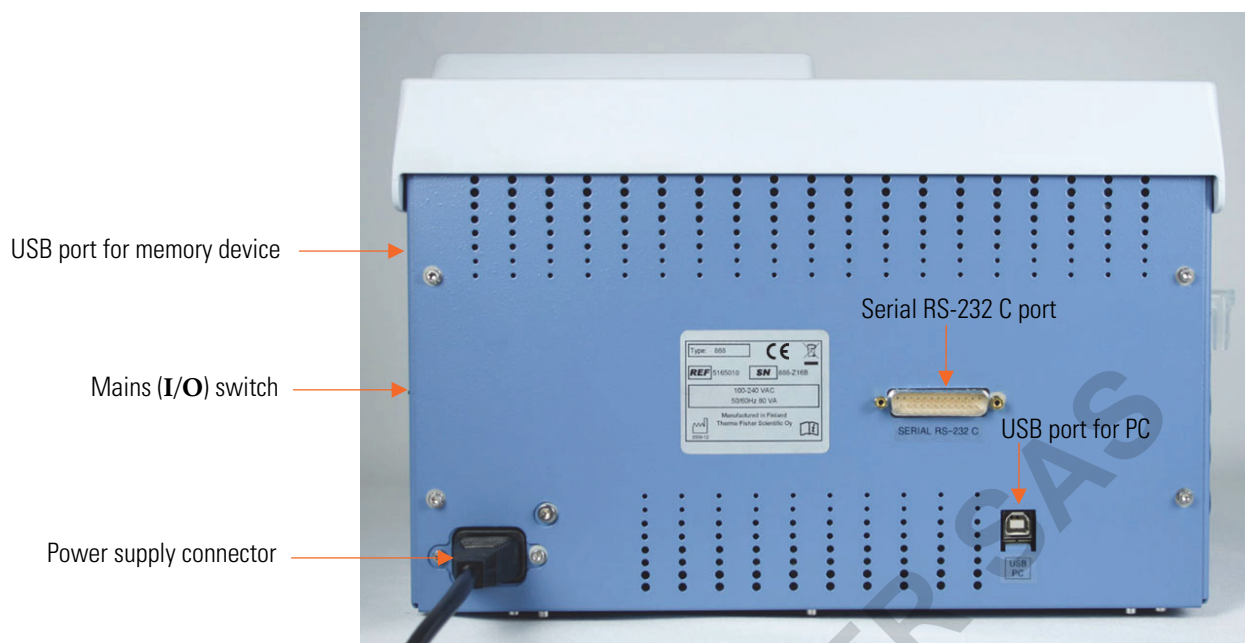

Figure 2–21. Connecting the power supply cable

Connecting to a computer

If you wish to use an external computer with the Wellwash Versa in remote control, connect the communication cable to the USB port for PC or serial RS-232 C port (Figure 2–21).

Warnings and cautions

This instrument is designed to provide full user protection. When correctly installed, operated and maintained, it will present no hazard to the user.

The following recommendations are given for added user safety.

Electrical

Ensure that the power supply cable supplied with the unit is always used. If a correct type of mains cable is not provided, use only cables certified by the local authorities.

The power plug should only be inserted into a socket outlet with a protective ground contact. Do not use an extension cable without a protective ground wire.



Warning Only authorized technical service personnel are allowed to open the instrument. ▲

The same precautions applicable when using any electrical equipment should naturally be observed with this instrument.



Warning Do not touch switches or electrical outlets with wet hands. Switch the instrument off before disconnecting it from the mains supply. ▲

Defects and abnormal stresses



This section describes defects and abnormal stresses.

Warning If the instrument is not functioning properly, it may create electromagnetic interference, which could impair the operation of other devices or equipment in the usual laboratory environment. ▲

Whenever it is likely that the protection system has been impaired, the instrument should be made inoperative and be secured against any unintended operation. Contact authorized technical service immediately.

The protection is likely to be impaired if, for example, the instrument:

- Shows any visible damage
- Fails to perform the intended functions
- Has been subjected to prolonged storage under unfavorable conditions
- Has been subjected to severe transport stresses.

Operating precautions and limitations before operation

1. Read this manual in its entirety, as it contains information necessary to ensure safe operation.
2. Always ensure that the electrical supply in the laboratory conforms to that specified on the type label at the rear of the instrument.
3. Ensure that the bottle and wash head tubing are properly fitted. Ensure that the intake tube reaches completely down to the bottom of the liquid bottle so that no red tubing is visible. Check regularly that the liquid filter in the intake tube is attached and clean.
4. Fill the wash and rinse bottles only after the installation and operational check of the system.
5. Check that the liquids are put in the correct bottles called for by the protocol.
6. Check that there is sufficient liquid in the liquid bottles and room in the waste bottle to run the protocol or series of protocols. Empty the waste bottle before a run or a series of runs.

The liquid level sensor will warn you if safe levels have been passed.



Caution To ensure proper function, do not disable or disconnect sensors. ▲

Installation

Mechanical checks before switching on

7. Check that correct wash heads are installed.
8. Check that the wash head configuration matches the configuration specified by the protocol. Calibrate the wash head if not yet calibrated.
9. Ensure that the priming vessel is empty and correctly installed.
10. Fit the microplate in the correct orientation appropriate for the wash head configuration. Note that if you do not load the microplate correctly onto the instrument, this will result in liquid spillage.



Caution Mismatching the wash head and plate orientation may cause spillage. ▲

11. Select the number of strips to be processed correctly. If there are strips missing on a plate, ensure that they are not selected for processing. If there are unused wells on the strip, it is recommended to fill unused wells with the same amount of deionized distilled water as in the used wells.

Mechanical checks before switching on

Before switching the instrument on:

- Move the wash head arm up and down, and the plate carrier back and forth to ensure that they move freely (Figure 2–22).
- Lift the wash head arm up and move the plate carrier under the wash head. Lower the wash head arm, with the wash head in place, so that the tips touch the plate carrier. Then move the plate carrier until the tips are aligned with the small circular indentations on the surface of the plate carrier. Check that the outermost tips in the wash head are directly above the indentations to ensure that the wash head arm is at a right angle to the plate carrier.

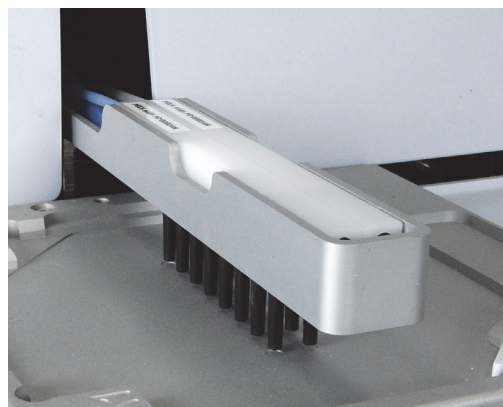

Figure 2–22. Alignment check

Installing the aerosol cover

The transparent aerosol cover may be present (Figure 3–24) or absent during operation. The aerosol cover primarily protects the user against biohazardous aerosols and the site against environmental contamination. Figure 2–23 shows the aerosol cover being installed. The corners have magnets for quick magnetic mounting of the cover.

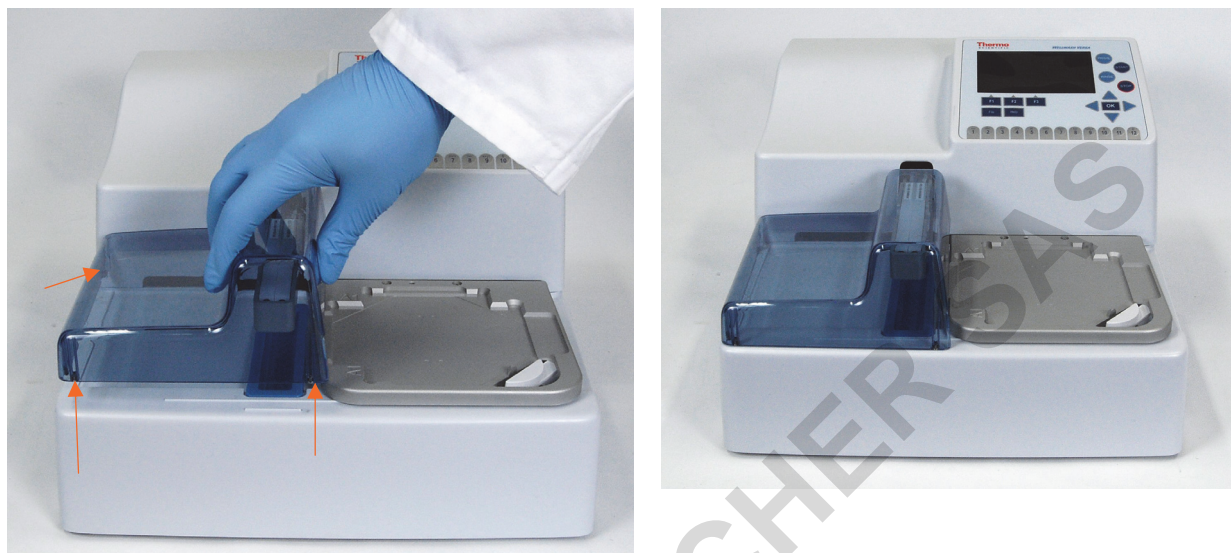

Figure 2–23. Installing the aerosol cover

Switching on

Switch the instrument on. The system performs initialization tests (= self diagnostics) each time it is switched on.

To change the preferred user interface language or the local date/time, refer to “Settings menu” on page 81.



Caution Do not switch the power off nor plug/unplug the USB memory device during “Performing self diagnostics”. ▲



Caution Do not touch the wash head or plate carrier when the instrument is in use. ▲



Note Ensure that the wash heads are installed. ▲

Performing the operational check after switching on

Before putting the instrument into use, perform the following operational check. For more information, refer to Chapter 4: “*Operating the Instrument*”.

- Ensure that the liquid bottles are empty.
- Turn the empty bottles upside down one by one to ensure that the liquid level sensor in the bottle works properly. The liquid level icon should be **green** when the buffer bottle is upside down and **red** when the buffer bottle is in an upright position. The liquid level

icon should be **red** when the waste bottle is upside down and **green** when the waste bottle is in an upright position. For more information, refer to “Liquid level detection” on page 42.

- Fill the buffer bottles completely with liquid.
- Prime all channels of the instrument to ensure that priming works; the liquid tubing is filled with liquid and is aspirated to the waste bottle. Check for possible air leaks in the liquid system. Lift the buffer bottle about 20 cm and ensure that the wash head tips are not dripping. For more information, refer to “Priming the system” on page 47.
- Check that the wash head configuration in the **Settings** menu corresponds to the installed wash head. The information is used to check for protocol wash head mismatches. Refer to “Wash head configuration” on page 84.
- Run a protocol, such as one of the demo protocols supplied with the instrument. The protocol should have an aspirate, dispense, shake, and soak function to ensure an adequate sample of functions to test the instrument’s proper operation. Check that the liquid channels and wash head tips work properly during dispensing and aspiration.



Settings after installation

Warning Clogged tips may cause a faulty washing performance. ▲

To change the wash head type, the preferred user interface language or the date/time, refer to “Settings menu” on page 81.

Chapter 3

Wellwash Versa Main Parts

This chapter describes the main parts of the Wellwash Versa instrument.

Instrument views

The front view of the Wellwash Versa instrument is shown in Figure 3–24.



Figure 3–24. Wellwash Versa front view with accessories

The back view of the Wellwash Versa instrument is shown in Figure 3–25.

Wellwash Versa Main Parts

Instrument views

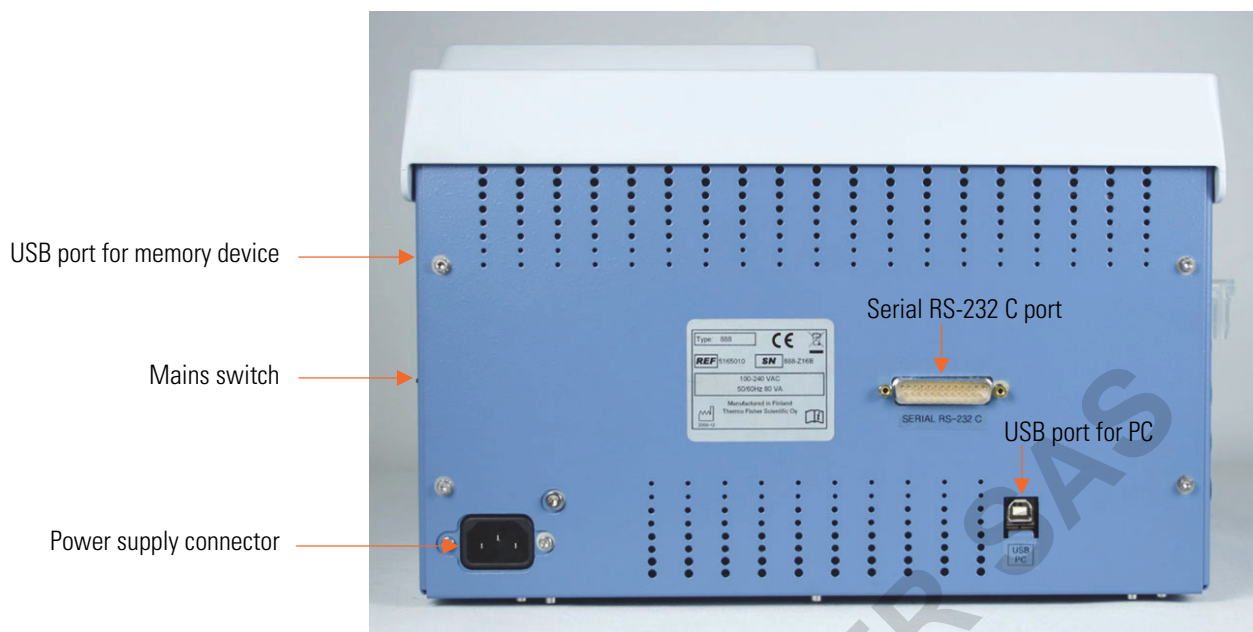

Figure 3–25. Wellwash Versa back view

The side views of the Wellwash Versa instrument are shown in Figure 3–26.



Figure 3–26. Wellwash Versa side views

Liquid system diagram

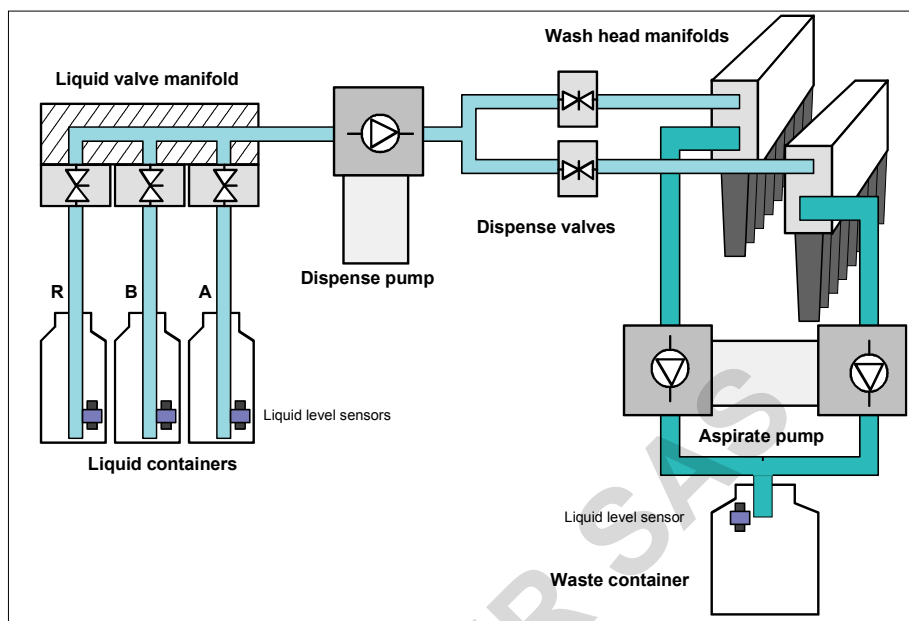

Figure 3–27. Liquid system diagram

USB memory device port

The instrument is equipped with a USB port for an external memory device (Figure 3–26). You can transfer wash protocols from one instrument to another of the same model with the USB memory device.



Note It is recommended to format the USB memory device if export or import fails. For more information, refer to Chapter 12: “*Troubleshooting Guide*”. ▲

You can check the functionality of the USB memory device by inserting it into the USB port for memory device (Figure 3–25). The “*WELLWASH*” folder will be created.

USB PC port

The instrument is equipped with a USB port for an external PC connection. The connection is used for remote control when connected, for example, to a robotic system and for service use. A separate manual, *Thermo Scientific™ Wellwash™ Versa Remote Control Command Sets* (Cat. No. D08894), is available on request.

Plate carrier

The plate carrier of the Wellwash Versa instrument supports both *portrait* and *landscape* orientation of the 96-well plate and *landscape* orientation of the 384-well plate (Figure 3–24). A plate clamp is incorporated into the plate carrier to keep the plate in place during processing. A sensor in the plate clamp senses the presence of a microplate.

Wash heads

The wash head alternatives (Figure 3–28) and their configurations (Figure 3–29) are shown below. Figure 3–29 shows how to set up wash heads for different configurations.



Warning Do not remove the wash head plugs when in use. ▲

Caution Only use wash heads that have an identification label. ▲

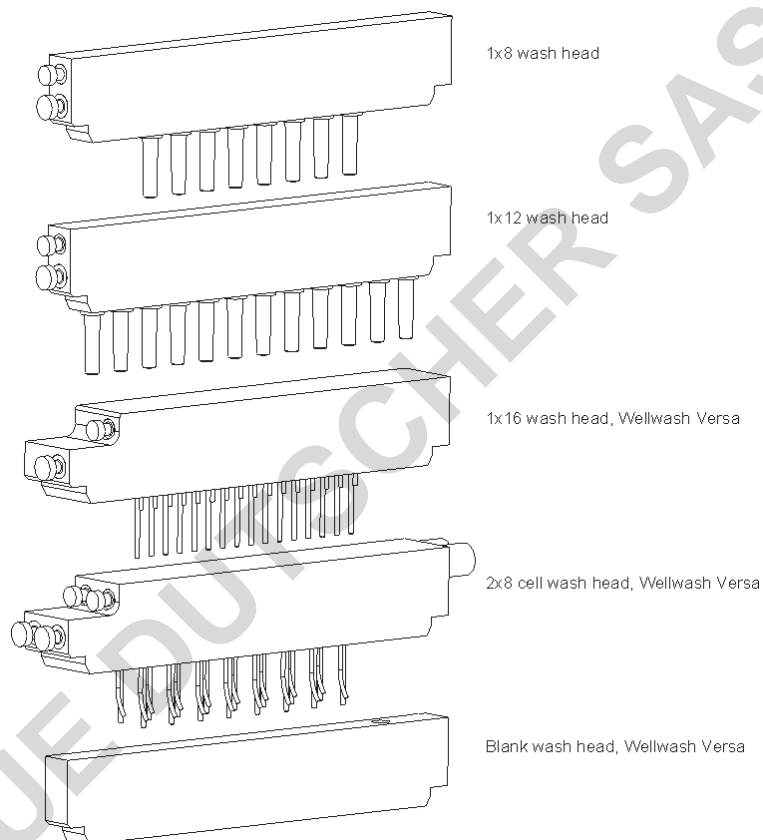

Figure 3–28. Wellwash Versa wash head models

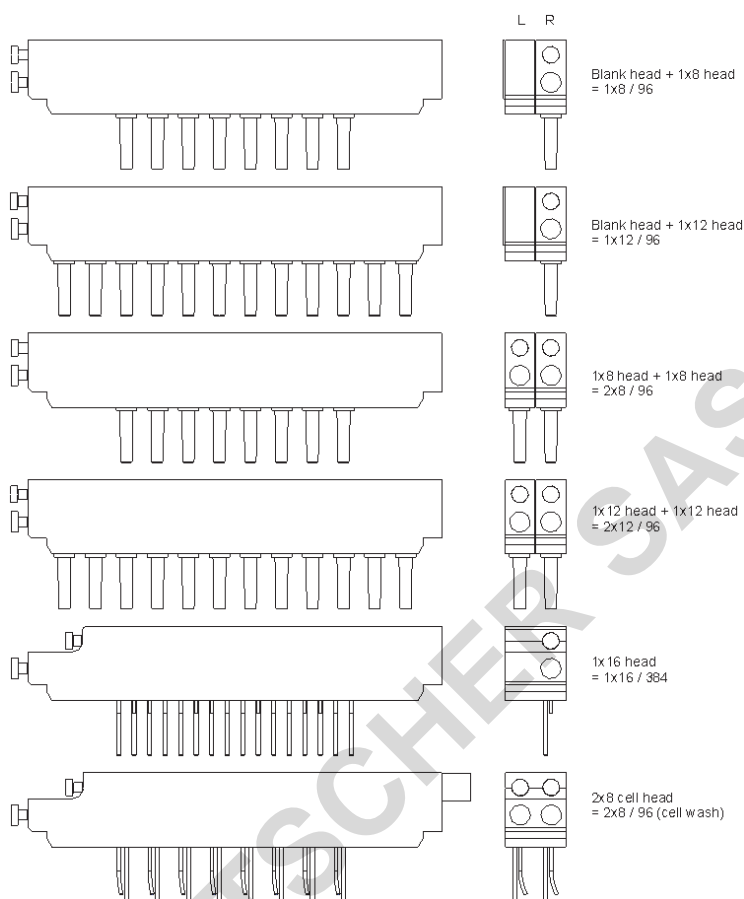

Figure 3–29. Configurations of Wellwash Versa wash heads

Shaker

It is possible to shake the microplate during the soak time to improve washing efficiency. The linear shaker operates at three different speeds (Table 3–1).

Table 3–1. Shaking speeds

Speed designation	Speed
Low	5 Hz, amplitude 2.5 mm
Medium	10 Hz, amplitude 1.5 mm
High	15 Hz, amplitude 1 mm



Caution The instrument is not intended for shaking purposes only. A separate microplate shaker is available if needed (e.g. Thermo Scientific™ iEMS™ Incubator/Shaker). Refer to www.thermoscientific.com. ▲

DOMINIQUE DUTSCHER SAS

Chapter 4

Operating the Instrument

Display and keys for navigating and editing

The keypad and display are shown in Figure 4–30.

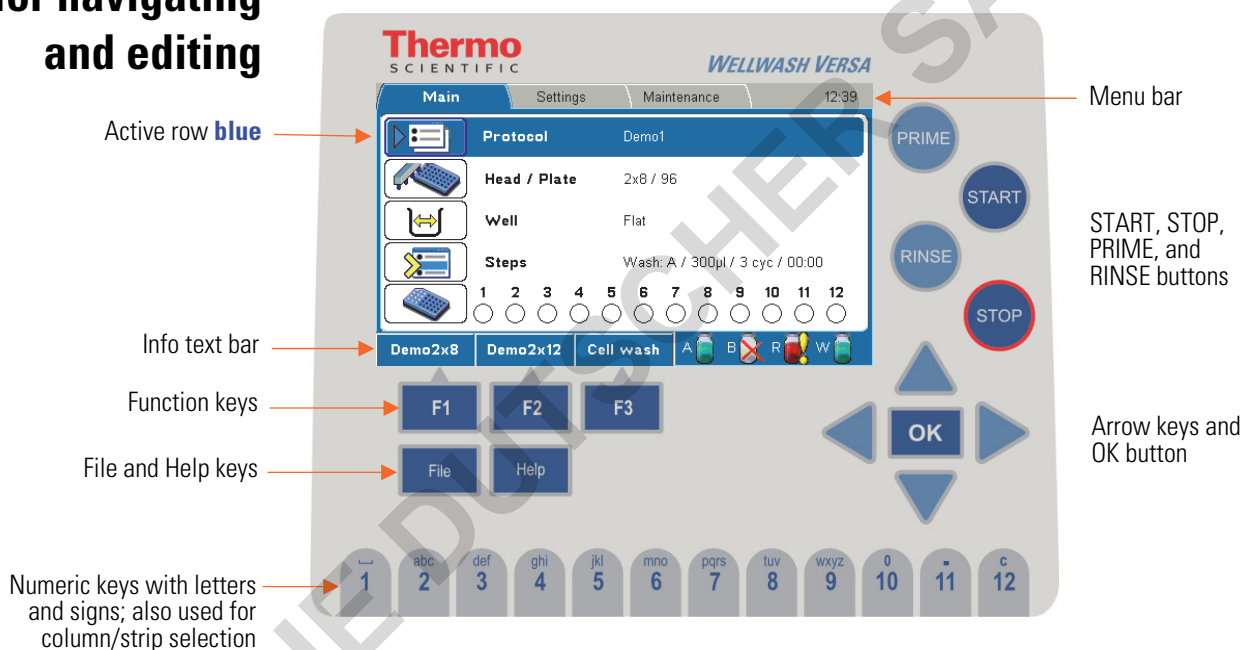

Figure 4–30. Keypad and display of the Wellwash Versa

The keys for navigating and editing are detailed below. The keys also have other functions depending on the level in the user interface.

The active row is colored **blue**.



Use the **Left**, **Right**, **Up**, and **Down** arrow keys to navigate. You can speed up the selection by holding down the arrow key.



Use the **OK** button to select, edit, or accept the highlighted item.

Operating the Instrument

Display and keys for navigating and editing



Use the **F1-F3** keys to select the corresponding action shown on the info text bar (Figure 4–30). The information on the info text bar is updated according to the active menu.

In the **Main** menu, the **F1-F3** function keys are reserved for protocols that you can assign to the keys for a quick selection. The instrument is shipped with three demo protocols assigned to the keys. To assign your own protocols to the keys, press the **FILE** key in the protocol list view and select **Quick Key**.



Press the **FILE** key, for example, to save the active protocol in the **Main** menu. Depending on the active menu, the **FILE** key opens a list of actions possible for the current protocol: *New*, *Open*, *Save*, *Save As*, *Quick Key*, *Export*, *Import*, and *Delete*, among others.



Use the **HELP** key for more detailed instructions about the context.



Press the **PRIME** button to prime the instrument.



Press the **RINSE** button to rinse the instrument.



Press the **START** button to start the execution of the currently selected protocol.



Press the **STOP** button to terminate the active protocol execution.

Pressing the button also returns the internal software to the previous state. In addition, this button can be used to terminate the possible computer remote control.



Use the character keys to enter numerical data and text.

- The space character is found under the **1** key.
- The following special characters are found under the **. / 11** key:
. - _ ' + ! ? % : ()
- The μ character is found under the **mno / 6** key.
- The **CLEAR (C / 12)** key is used to delete written text or numbers.

Use the keys to select strips. Refer to “Strip selection with the number keys” on page 49.

To write an uppercase letter, press the desired letter key repeatedly until the capital appears.

Menus

The internal software includes the **Main**, **Settings**, and **Maintenance** menus.

The menu layout is displayed in Table 4–2.

Table 4–2. Program overview

Main	Settings	Maintenance
└ Protocol	└ Prime & rinse parameters	└ Clean
└ Head / Plate	└ Sensors	└ Calibration
└ Well	└ Wash head configuration	└ Service
└ Steps	└ System	
└ Layout	└ Reports	

Main menu

You can specify the protocol-related parameters and manage the run of the active protocol in the **Main** menu.

The **Main** menu contains the **Protocol**, **Head / Plate**, **Well**, **Steps**, and **Layout** rows, and their parameters.

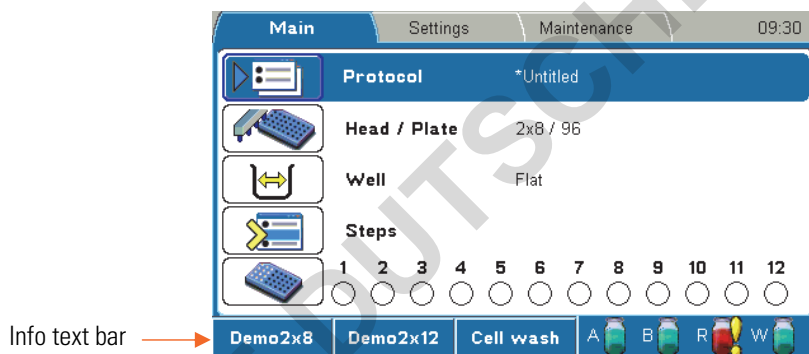

The clock on the menu bar shows the local time.



Note that the **blue** clock icon appears on the menu bar when **Autorinse** or **Autoprime** is active.

* An asterisk in front of a protocol name means that the protocol has not yet been saved.

 A yellow caution symbol on the **Head / Plate** row means that the current protocol has a different wash head than the one defined in the **Settings** menu. Refer to “Wash head configuration” on page 84.



See the info text bar for the required actions of the **F1-F3** keys. The action text on the info text bar changes according to the current menu.

Liquid level detection

The info text bar also shows the liquid level in the bottles (**A**, **B**, **R**, and **W**). The liquid bottles have sensors to enable liquid level detection. Fill the buffer bottles and empty the waste bottle if the red bottle icon appears on the info text bar. Refer to “Sensors” on page 83.



Liquid level detection (LLD):

Liquids A, B, and Rinse

- icon is *green* when the bottle is filled with liquid
- icon is *red* with an exclamation mark when the bottle is nearly empty or disconnected (The warning is activated when there is approximately 290 ml in the 2 liter wash bottle / 580 ml in the 4 liter wash bottle.)
- icon is *empty* with a cross when the LLD is disabled

Waste

- icon is *red* with an exclamation mark when the bottle is full or disconnected
- icon is *green* when the bottle is not yet full
- icon is *empty* with a cross when the LLD is disabled

Chapter 5

Running Protocols

1. Ensure that the buffer solutions in the bottles A, B, and Rinse are correct and that there is sufficient liquid for the protocol. Also ensure that the Waste bottle is not full when you begin. Ensure that the liquid level sensors are enabled and symbols are **green**. Refer to “Liquid level detection” on page 42. Ensure that the tubing is properly fitted.

The liquid levels in the bottles are monitored during runs. Follow the color-coded bottle icons on the info text bar. Refer to “Filling and emptying liquid bottles” on page 44.

Ensure that the intake tube is fixed to the lowest position on the cap, whereby no red tubing is visible above the cap, and fully immersed in the buffer bottle.

2. Select a protocol. Refer to “Starting ready-made protocol” on page 44.

The selected protocol name is shown on the **Protocol** row in the **Main** menu.

3. Ensure that the protocol parameters are correct.
4. Insert the 96- or 384-well plate to be washed onto the plate carrier and ensure that the microplate is correctly oriented according to the wash head configuration.

The A1 position of the plate is in the upper left corner when the *nx8* or *1x16* wash head is in use and in the lower left corner for the *nx12* wash head. Refer to “Loading the plate” on page 46.

If you are using strip plates, ensure that the individual strips are properly attached to the plate frame.

Ensure that the plate is not covered.



5. Press the **PRIME** button to prime the instrument. Refer to “Priming the system” on page 47.



6. Select the strips if they are not already selected. Refer to “Strip selection” on page 48.



7. Press the **START** button.
8. The microplate is processed according to the predefined protocol.
9. Check that the liquid channels work properly during dispensing and aspiration.
10. If you need to abort the run, press the **STOP** button during the run.
11. Remove the plate after the protocol has ended.
12. Rinse the instrument. Refer to “Rinsing the liquid system” on page 51.



Note If you use a partial strip plate, make sure that your column/strip selection matches the physical strips on the plate. ▲



Note Do not remove the plate before the end of the protocol run. ▲



Note It is recommended to shut down the Wellwash Versa at the end of the day. Refer to “Shutting down” on page 109. ▲

Filling and emptying liquid bottles

1. Disconnect the liquid bottles and fill or empty them if needed. Refer to “Liquid level detection” on page 42.
2. Unscrew the liquid bottle cap and fill with a suitable buffer solution.
3. Replace the liquid bottle cap and reinstall the liquid or waste bottle. Refer to “Liquid bottles and channels” on page 22.
4. Always reprime the system before running a protocol. Refer to “Priming the system” on page 47.

Starting ready-made protocols

You can select a protocol using the quick keys or from the protocol list and start it.

Starting a ready-made protocol with the quick keys

F1-F3 function keys

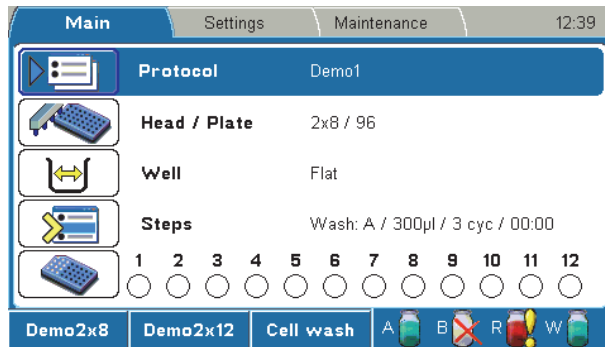

Use the **F1-F3** function keys reserved for ready-made, demo or favorite protocols. Three default protocols may be connected to the **F1-F3** keys. You may change these protocols from Protocol > OK > FILE > Quick Key > **Set/Clear F1-F3**.

Starting a ready-made protocol from the list

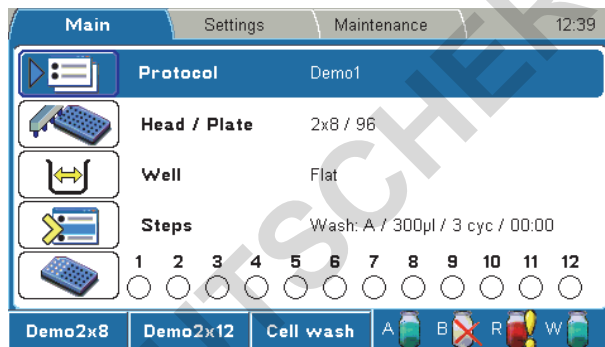

1. Press the **OK** button on the **Protocol** row in the **Main** menu.

OR



Press the **FILE** key in the **Main** menu and select *Open* using the **Down** arrow key, and then press the **OK** button.

Example protocol list

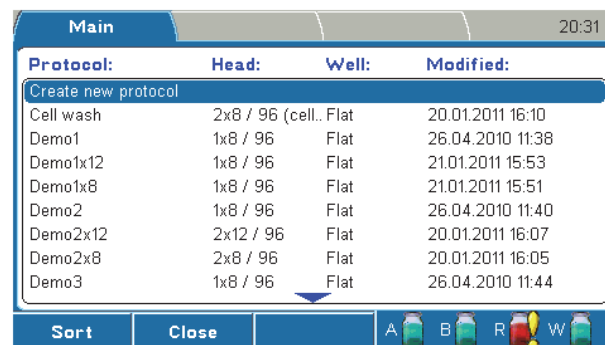

2. Select the ready-made protocol and press the **OK** button.

Loading the plate

The wash head defines the plate type and orientation (Table 5–3 and Figure 5–31 and Figure 5–32).

Table 5–3. Wash head vs. plate and orientation

Wash head	Plate	Orientation
nx8	96-well plate	Landscape
2x8 (cell wash)	96-well plate	Landscape
nx12	96-well plate	Portrait
1x16	384-well plate	Landscape

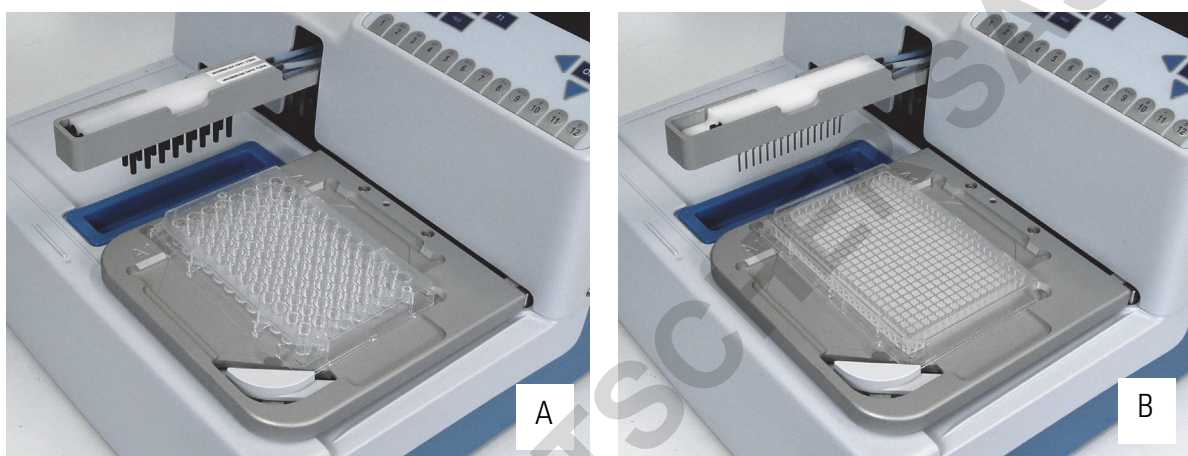

Figure 5–31. 2x8 orientation (A) and 1x16 orientation (B)



Figure 5–32. 2x12 orientation



Caution Ensure that the microplate is correctly oriented to match the wash head (Table 5–3). ▲



Caution Ensure that the strips on a strip plate are pressed flat on the frame. Misaligned strips may increase the residual volume or limit plate carrier movement. ▲



Caution Ensure that the plate is not covered. ▲



Caution Do not limit the plate clamp operation. ▲

Insert the 96- or 384-well plate to be washed onto the plate carrier (Figure 5–33). Position A1 of the plate should correspond to position A1 marked on the plate carrier. The plate clamp will hold the plate in position during the run.



Figure 5–33. Inserting the microplate



Caution Ensure that the strips in strip plates are positioned in the microplate as selected in the user interface, otherwise spilling may occur and the instrument may become contaminated. ▲



Caution For proper performance, all wells in a strip should have an equal amount of liquid. It is recommended to use deionized distilled water in unused wells on the strip. ▲

Priming the system

Press the **PRIME** button to fill the liquid tubing completely from the selectable buffer bottle intake tube to the wash head tips. If you prime for the first time, fill the buffer bottle completely to ensure proper priming. The default priming volume is *30 ml* to fill the liquid tubing properly. On subsequent priming occasions when the tubing contains the desired liquid, you can use a smaller priming volume. The dead volume of the liquid tubing is 20 ml (see Figure 5-34).

If the instrument will be left to stand for a longer time, priming must be performed with air to remove all liquid from the system. Raise the tube from the liquid to allow air to enter the tube.

The default volume used during priming is defined in the Settings > Prime & rinse parameters > **Prime volume (Prime button) (ml)** menu. Refer to “Prime & rinse parameters” on page 81.

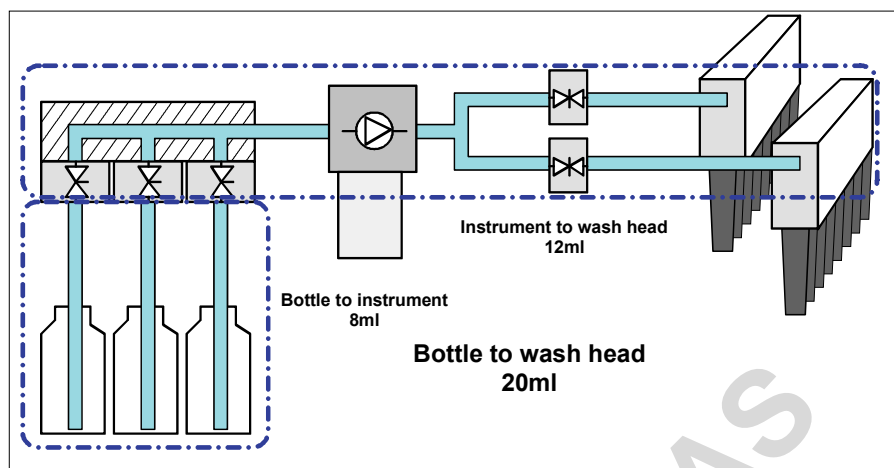

Figure 5–34. Dead volumes of the liquid tubing



Caution Prime the liquid system with the liquid to be used (wash buffer). Ensure that the dispensing pump is not run for longer than a few minutes without liquid, otherwise it may be damaged. Check for possible air leaks. ▲



Note If the instrument has not been used for a longer time, you might need to perform the Boost prime option. Refer to “Service” on page 102. ▲



Note In case of two-buffer protocols, both the buffer channels have to be primed before the protocol is started. If channels are switched within the same protocol, add a Prime step to the protocol to ensure that liquid in the tubing is replaced completely (a volume of at least 15 ml is required). ▲

Strip selection



Strip selection can be carried out in two ways:

1. To select the columns/strips of the plate, use the number keys.
OR
2. Press the **OK** button on the **Layout** row in the **Main** menu.

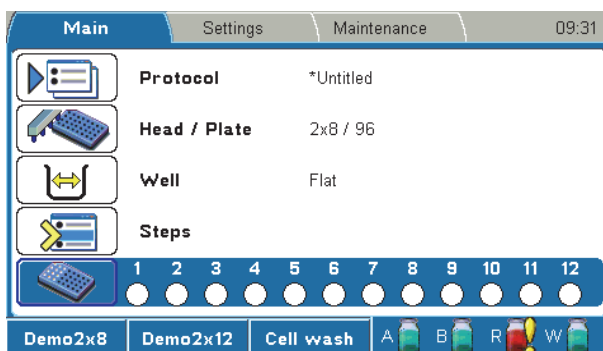

Strip selection with the number keys



It is possible to select the strips with the number keys regardless of which row is highlighted in the **Main** menu.

The following rules apply when selecting the columns/strips:

- 1x8 wash head: Press the keys 1 to 12, any combination.
- 1x12 wash head: Press the keys 1 to 8, any combination.
- 1x16 wash head: strips 1 to 24 (press number keys 1–12 to select two strips at a time)
- 2x8 wash head: strips 1 to 12 (press number keys 1–12 to select two strips at a time)
- 2x12 wash head: strips 1 to 8 (press number keys 1–8 to select two strips at a time)
- All columns/strips: Double-press the 8 or 12 key to select all columns/strips when the selection is empty.
- Select or unselect a column/strip: Press the corresponding number key.
- Range of strips: First select the starting strip and then double-press the key corresponding to the final strip in the range.
- Deselect a range of strips: Double-press a key to delete all selected strips in descending order.
- Clear all selections: Hold the **C / 12** key down for more than 2 seconds.



Note Strip selection is disabled if the Layout step is the first step of the protocol. Refer to “Layout” on page 80. ▲

Strip selection with the Layout row

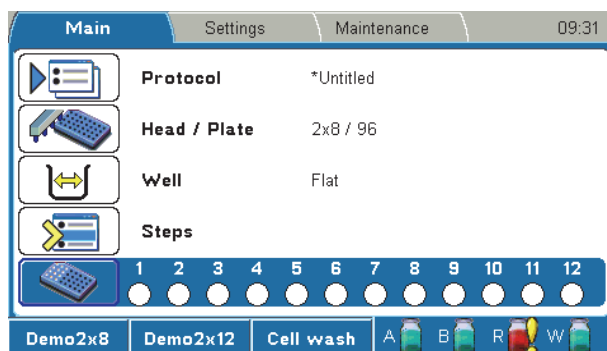

Select the **Layout** row in the **Main** menu and press the **OK** button.

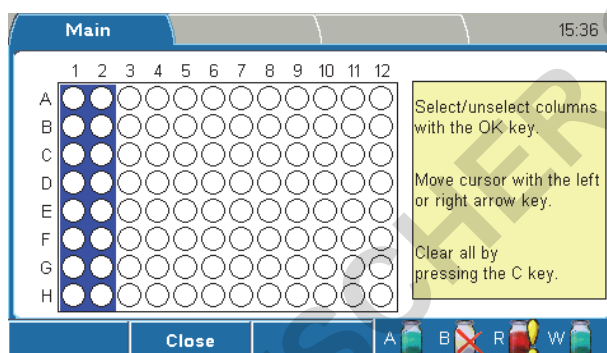

Select/unselect columns/strips by pressing the **OK** button and move the cursor using the **Left** or **Right** arrow key.

All selections are cleared with the **C** key.

Columns/strips 1–12 are edited if an 8-way wash head is used or columns/strips 1–8 if a 12-way wash head is used.

The selected columns/strips are highlighted with **red** color.

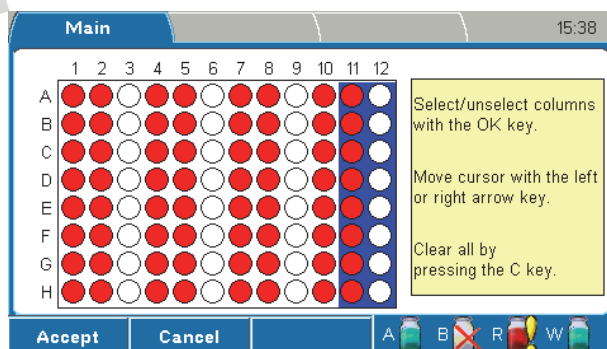

Starting a run

To start a run:



1. Press the **START** button to start the run.

The microplate will be processed according to the protocol.



Note Ensure that the liquid channels work properly during dispensing and aspiration. ▲

2. Remove the plate after the protocol has ended.



Note Prime the instrument with deionized distilled water at the end of the batch. ▲

Canceling a run

To cancel a run:



Press the **STOP** button to cancel a run.



Note It is not possible to stop the run when a user input is required as a response to a warning or error message. ▲

Rinsing the liquid system

The **RINSE** button starts a sequence where the rinse liquid is pumped through the liquid system for a short period of time and left in the tubing. The rinse solution is normally deionized distilled water.

The volume used during rinsing is defined in the Settings > Prime & rinse parameters > **Rinse volume (Rinse button) (ml)** menu. Refer to “Prime & rinse parameters” on page 81.

Running Protocols

Rinsing the liquid system

DOMINIQUE DUTSCHER SAS

Chapter 6

Menus, Tabs and Parameters

Display and keys for navigating and editing

The keypad and display are shown in Figure 6–35.

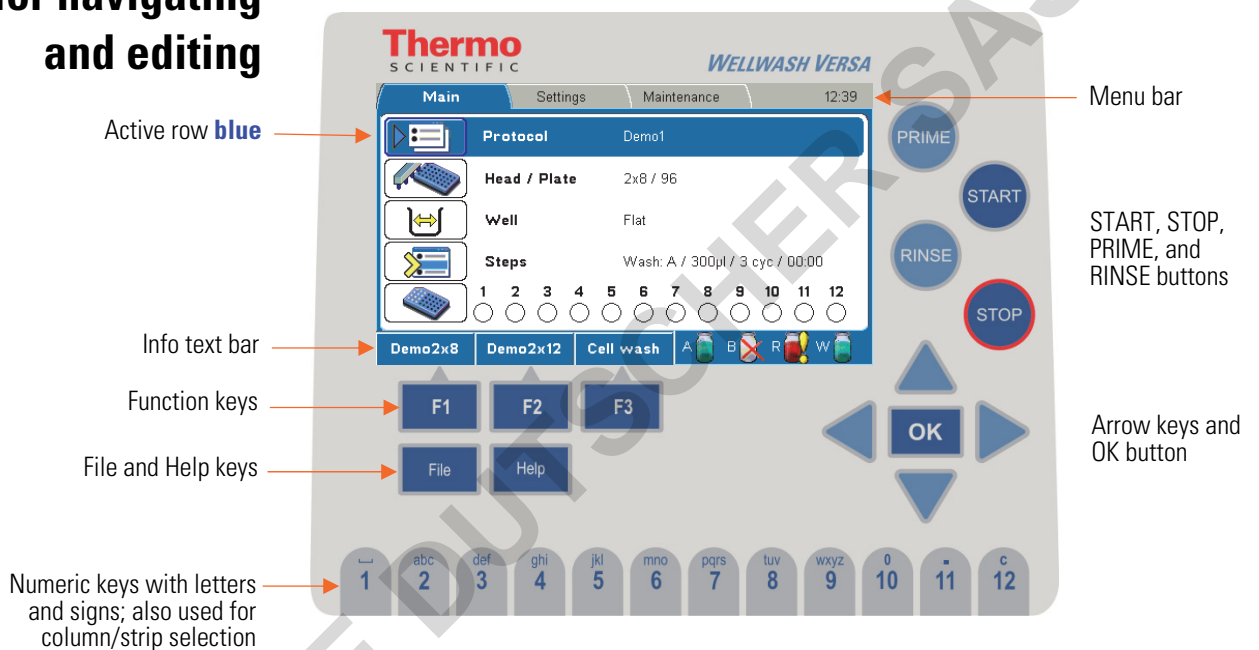

Figure 6–35. Keypad and display of the Wellwash Versa

The keys for navigating and editing are detailed below. The keys also have other functions depending on the level in the user interface.

The active row is colored **blue**.



Use the **Left**, **Right**, **Up**, and **Down** arrow keys to navigate. You can speed up the selection by holding down the arrow key.



Use the **OK** button to select, edit, or accept the highlighted item.

Menus, Tabs and Parameters

Display and keys for navigating and editing



Use the **F1-F3** keys to select the corresponding action shown on the info text bar (Figure 6–35). The information on the info text bar is updated according to the active menu.

In the **Main** menu, the **F1-F3** function keys are reserved for protocols that you can assign to the keys for a quick selection. The instrument is shipped with three demo protocols assigned to the keys. To assign your own protocols to the keys, press the **FILE** key in the protocol list view and select **Quick Key**.



Press the **FILE** key, for example, to save the active protocol in the **Main** menu. Depending on the active menu, the **FILE** key opens a list of actions possible for the current protocol: *New*, *Open*, *Save*, *Save As*, *Quick Key*, *Export*, *Import*, and *Delete*, among others.

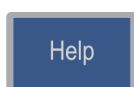

Use the **HELP** key for more detailed instructions about the context.



Press the **PRIME** button to prime the instrument.



Press the **RINSE** button to rinse the instrument.



Press the **START** button to start the execution of the currently selected protocol.



Press the **STOP** button to terminate the active protocol execution.

Pressing the button also returns the internal software to the previous state. In addition, this key can be used to terminate the possible computer remote control.



Use the character keys to enter numerical data and text.

- The space character is found under the **1** key.
- The following special characters are found under the **. / 11** key:
. - _ ' + ! ? % : ()
- The μ character is found under the **mno / 6** key.
- The **CLEAR (C / 12)** key is used to delete written text or numbers.

Use the keys to select strips. Refer to “Strip selection with the number keys” on page 49.

To write an uppercase letter, press the desired letter key repeatedly until the capital appears.

Menus The internal software includes the **Main**, **Settings**, and **Maintenance** menus.

The menu layout is displayed in Table 6–4.

Table 6–4. Program overview

Main	Settings	Maintenance
└ Protocol	└ Prime & rinse parameters	└ Clean
└ Head / Plate	└ Sensors	└ Calibration
└ Well	└ Wash head configuration	└ Service
└ Steps	└ System	
└ Layout	└ Reports	

Main menu You can specify the protocol-related parameters and manage the run of the active protocol in the **Main** menu.

The **Main** menu contains the **Protocol**, **Head / Plate**, **Well**, **Steps**, and **Layout** rows, and their parameters.

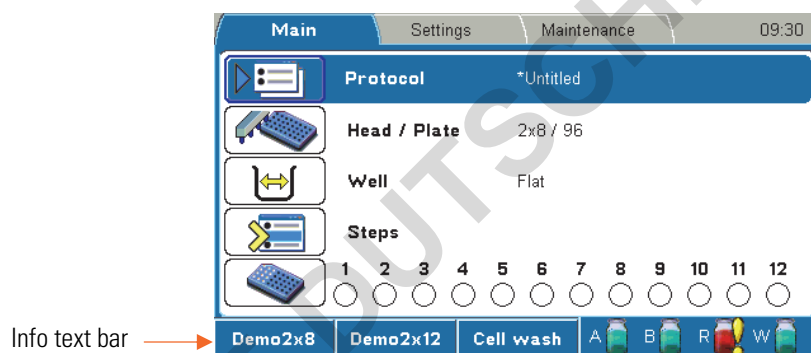

The clock on the menu bar shows the local time.



Note that the **blue** clock icon appears on the menu bar when **Autorinse** or **Autoprime** is active.

* An asterisk in front of a protocol name means that the protocol has not yet been saved.

 A yellow caution symbol on the **Head / Plate** row means that the current protocol has a different wash head than the one defined in the **Settings** menu. Refer to “Wash head configuration” on page 84.



See the info text bar for the required actions of the **F1-F3** keys. The action text on the info text bar changes according to the current menu.

Liquid level detection

The info text bar also shows the liquid level in the bottles (A, B, R, and W). The liquid bottles have sensors to enable liquid level detection. Fill the buffer bottles and empty the waste bottle if the red bottle icon appears on the info text bar. Refer to “Sensors” on page 83.



Liquid level detection (LLD):

Liquids A, B, and Rinse

- icon is *green* when the bottle is filled with liquid
- icon is *red* with an exclamation mark when the bottle is nearly empty or disconnected (The warning is activated when there is approximately 290 ml in the 2 liter wash bottle / 580 ml in the 4 liter wash bottle.)
- icon is *empty* with a cross when the LLD is disabled

Waste

- icon is *red* with an exclamation mark when the bottle is full or disconnected
- icon is *green* when the bottle is not yet full
- icon is *empty* with a cross when the LLD is disabled

Protocol

The **Protocol** row in the **Main** menu shows the name of the active protocol.

You can open another protocol by pressing the **OK** button on the **Protocol** row or by pressing the **FILE** key. The list of protocols saved in the software will appear. The protocols are listed in alphabetical order by protocol name. At least 100 wash protocols can be saved to memory.

Protocol:	Head:	Well:	Modified:
Create new protocol			
Cell Wash	2x8 / 96 (cell.. Flat		30.05.2011 16:34
Demo1	2x8 / 96	Flat	30.05.2011 16:30
Demo2	2x8 / 96	Flat	30.05.2011 16:29
Demo2x12	2x12 / 96	Flat	30.05.2011 16:25
Demo2x8	2x8 / 96	Flat	30.05.2011 15:58
Demo3	2x8 / 96	Flat	30.05.2011 15:57
Demo384	1x16 / 384	Flat	30.05.2011 16:04
DemoLayoutPause2x8	2x8 / 96	Flat	30.05.2011 16:12

It is possible to protect protocols from accidental editing or deleting. A locked symbol is shown in front of the protocol name when locked.

To lock/unlock a protocol, select it on the protocol list and press the **F3** (Lock) key.

For more details on opening a protocol, refer to “Starting ready-made protocols” on page 44.

For instructions on how to start, create, and save protocols, refer to Chapter 5: “Running Protocols” and “Creating a protocol” on page 57.

Creating a protocol

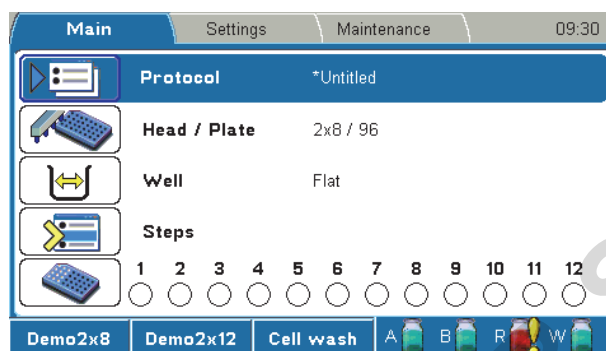

1. Press the **FILE** key in the **Main** menu to create a new protocol. Refer to “Protocol” on page 56.



2. Select *New* and press the **OK** button.



3. Select the **Head / Plate** row. Refer to “Head / Plate” on page 63.

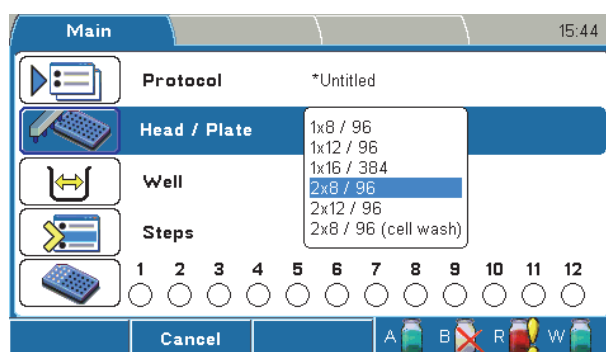

4. Select the wash head and plate.

If the selected wash head is different from the one that is set in the **Settings** menu, you must change the wash head in the **Settings** menu before starting the protocol. Refer to “Wash head configuration” on page 84.



Caution If you edit an existing protocol and change the wash head(s), the wash head related step parameters of the protocol (e.g. the Wash step) are automatically reset to default values. Soak and Pause steps are not affected. ▲

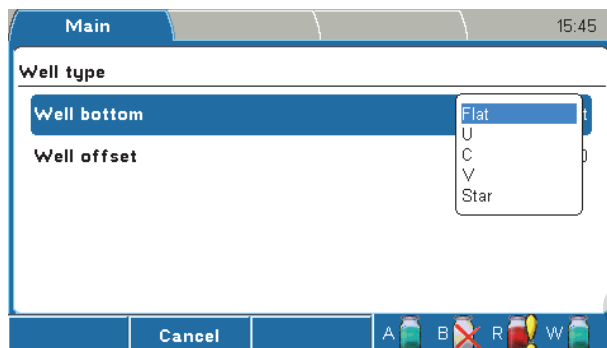

5. Select **Well**. The **Well type** window opens. Refer to “Well” on page 64.



6. Select the well bottom shape of the plate or strips.



7. Select **Well offset** to adjust the well offset value. For more information on the Preview function, refer to “Well” on page 64.



Note Well offset has an effect on the residual volume. ▲



8. Select the **Steps** row in the **Main** menu. Refer to “Steps” on page 66.

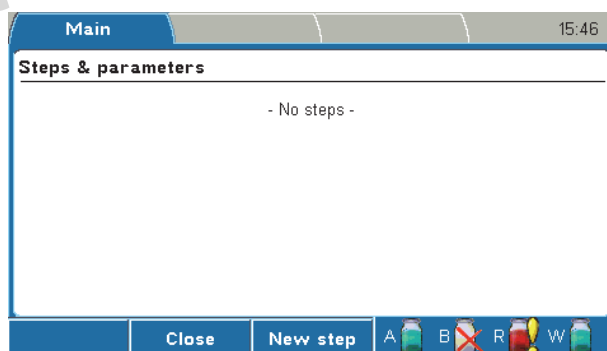

9. Press the **F3** (New step) key to open the step list box.

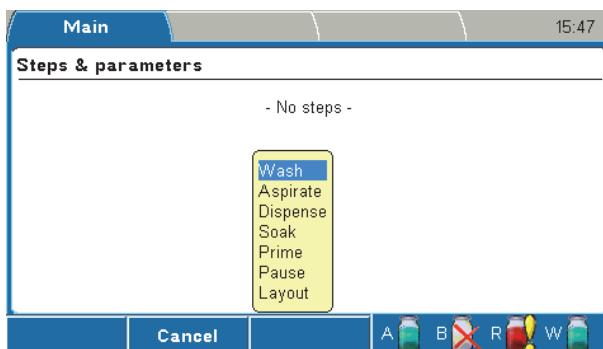

10. Select the step.

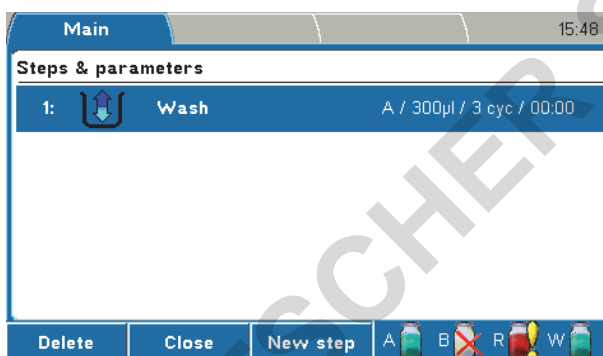

Steps are listed and numbered in the order of execution. It is possible to create several steps in the step list and process the steps in the defined sequence.

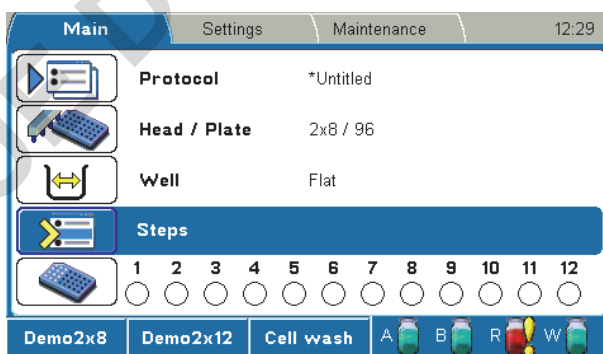

For more information on the step parameters, refer to “Steps” on page 66.



11. Press the **FILE** key in the **Main** menu. Note that the strip selection is not saved with the protocol. Use the Layout step if you want to save the strip selection.



12. Select *Save As*. The *Save Protocol As* dialog opens.

Menus, Tabs and Parameters

Main menu



13. Enter the protocol name, for example, *Test1*, by using the character keys. The protocol is now created.



Note You cannot use the protocol name “*Untitled*”. ▲

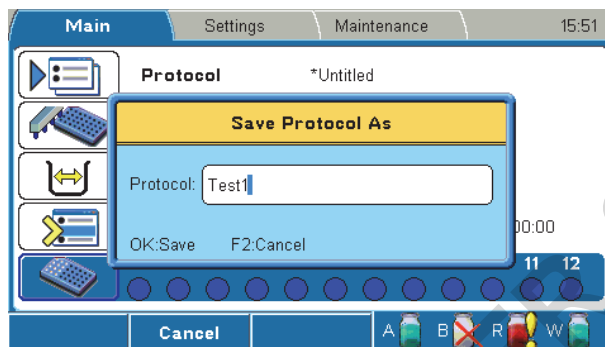

Note You cannot save a protocol with a name already in use. ▲

Creating a protocol in an optional way



You can also create a protocol using the **Protocol** window.



1. Select the **Protocol** row in the **Main** menu and press the **OK** button.
2. Select the **Create a new protocol** row and press the **OK** button.

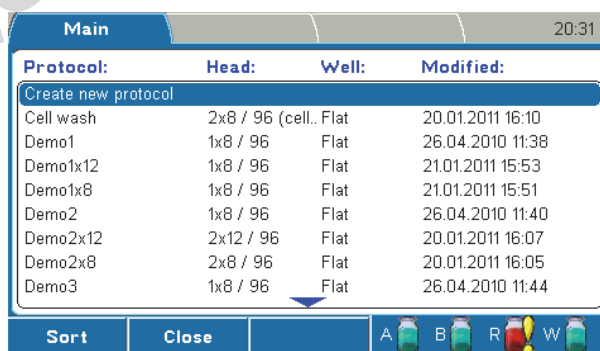

3. Enter a name for the protocol and press the **OK** button.

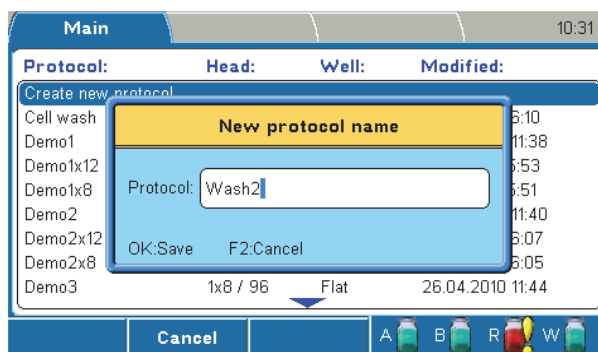

4. In the **Main** menu, set the desired protocol parameters and steps.

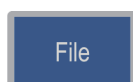

5. When ready, press the **FILE** key and select *Save* to save your protocol.

Adding new steps to protocols

To add a new step to a protocol:



1. Select the **Steps** row in the **Main** menu and press the **OK** button.

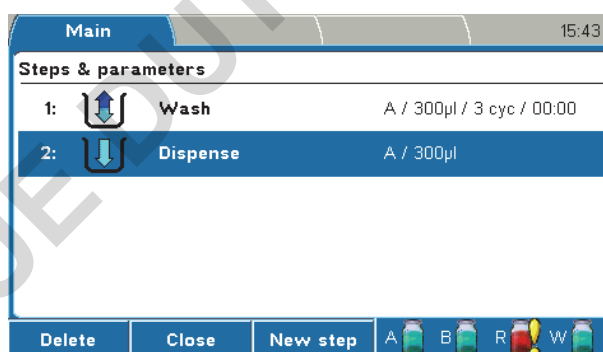

2. Press the **F3** (New step) key to open the step list box.

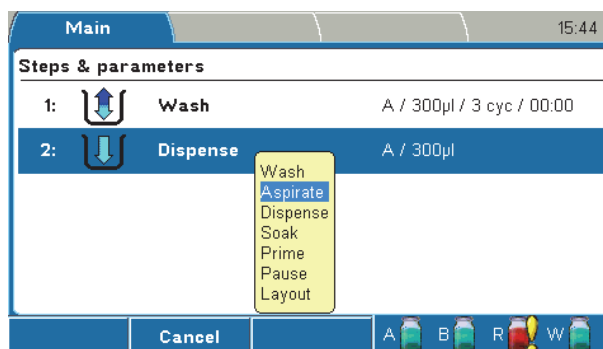

Menus, Tabs and Parameters

Main menu

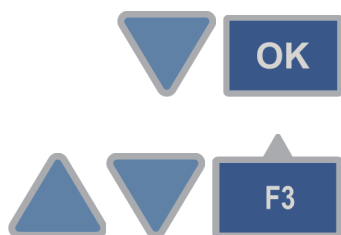

3. Select the step and press the **OK** button.

4. A flashing insert bar with the selected step appears. Select the position where you want to insert the step by using the **Up** or **Down** arrow key and then press the **F3** (Insert) key.

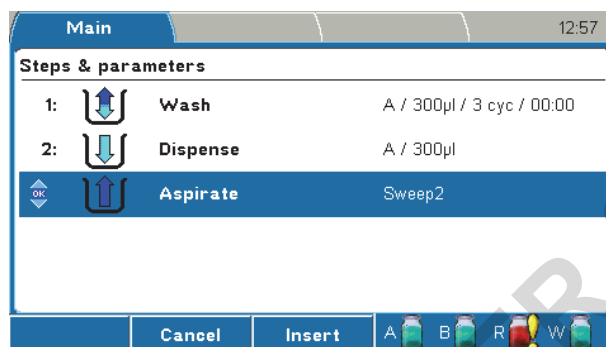

5. Press the **OK** button to edit the new step. For more information on steps, refer to “Steps” on page 66.

6. Save the changes you make in each step using the *File – Save* functions.



7. Press the **F3** (New step) key to add further new steps to the protocol.

When there are more than five steps, **blue** arrows appear at the bottom and/or at the top of the display.

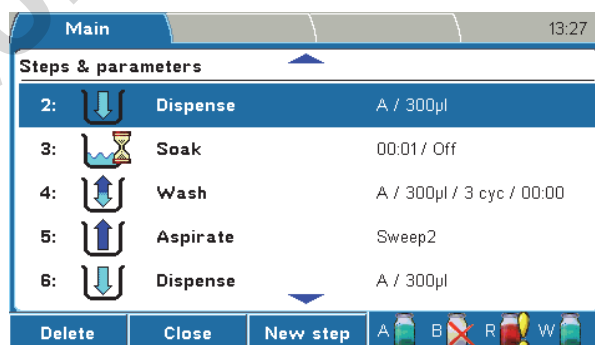

8. Use the **Up** and **Down** arrow keys to navigate in the protocol.

Deleting steps from protocols

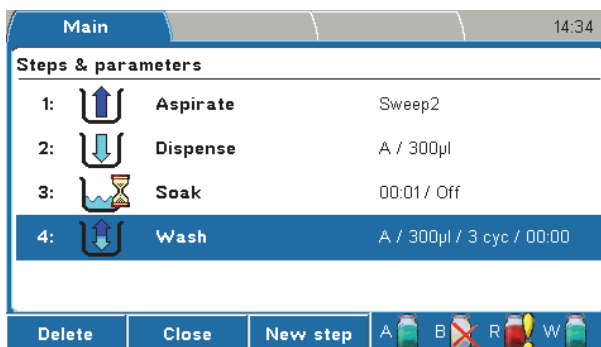

1. Select the step you want to delete and press the **F1** (Delete) key.

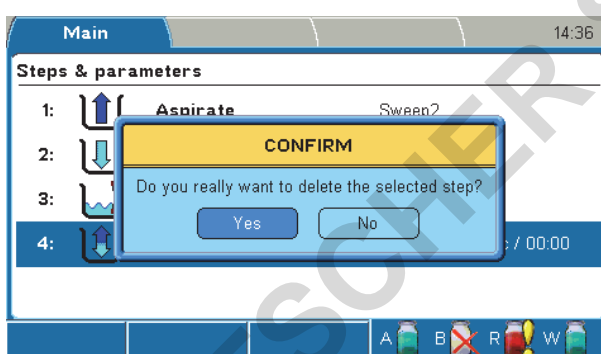

2. Press the **OK** button to confirm the deletion.

Head / Plate

You can select the wash head and plate format on the **Head / Plate** row in the **Main** menu.



Caution If you edit an existing protocol and change the wash head, the wash head related step parameters of the protocol (e.g. the Wash step) are automatically reset to default values. Soak and Pause steps are not affected. ▲

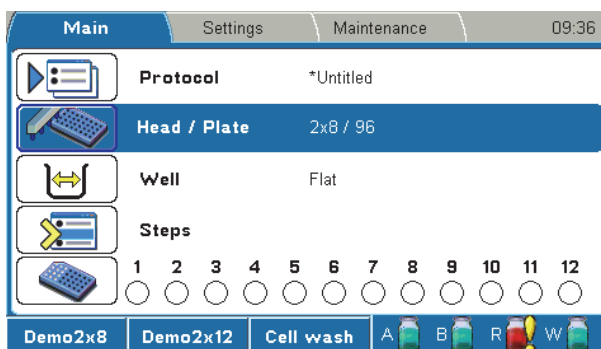



When you press the **OK** button, the wash head/plate list box appears.

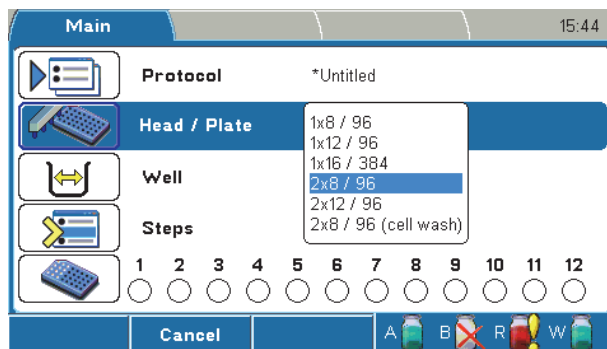

The default wash head setting is set in the **Settings** menu. When a one-column wash head (1x8 or 1x12) is used, the blank wash head should always be on the left of the wash head arm (viewed from the front).



Select the wash head and plate and press the **OK** button. Refer to “Wash head configuration” on page 84 and “Creating a protocol” on page 57.



Note Calibrate the wash head(s) if not already calibrated. ▲

Well

You can select the well shape and well offset on the **Well** row in the **Main** menu.

If you change the well shape, check the step parameters afterwards.



When you press the **OK** button, the **Well type** window appears.

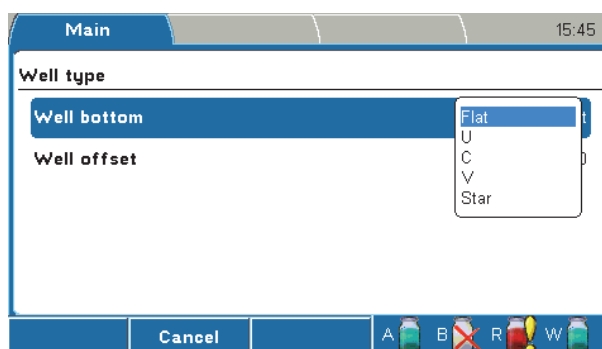

The following settings are available:

- **Well bottom** – Select the well shape.

Different well shapes of strips and plates available are shown in Figure 6-36. The default well shape format is *Flat*.



Note If a 384-well plate with a 1x16 / 384 wash head is selected, you can select only the *Flat* well shape. ▲



Note If a 96-well plate with a 2x8 / 96 (cell wash) wash head is selected, you can select only the *Flat*, *U*, and *C* well shapes. ▲



Note The well shape has an effect on the aspirate height and aspirate mode. ▲



Flat
Flat
bottom

C
Flat bottom
with curved
edges

U
Round
bottom

V
V bottom

Star A
Flat bottom
with curved
edges and 8 ribs

Star B
Showing the
orientation
of the 8 ribs

Figure 6-36. Well shapes

- **Well offset** – Adjust the X offset of a plate. Adjustment is required primarily with a 384-well plate. The offset value ranges from -1.5 mm to 1.5 mm in increments of 0.1 mm.



Caution With 384-well plates, check that the offset limit is not too big to prevent dispensing outside the wells. ▲



Use the **Up** and **Down** arrow keys to adjust the value.



Press the **F3** (Preview) key to move the plate carrier and align the wash head over the first column of a plate. Then press the **Up** or **Down** arrow key to move the plate carrier in steps of 0.1 mm.



Warning Well offset has an effect on the residual volume in the well. With U- and V-shaped wells, setting the well offset off center will increase the residual volume. ▲



Note With Flat bottom wells, setting the well offset off center may decrease the residual volume. This feature should only be used with the Normal aspirate mode. ▲



Press the **OK** button to accept the value and/or the **F2** (Close) key to close the window.

Microplate requirements

Both 96- and 384-well format microplates that meet ANSI/SBS standards can be used with the Wellwash Versa (Table 6–5).



Note Use only plates manufactured according to ANSI/SBS standard dimensions. ▲

Table 6–5. Microplate requirements

Well plate	Default plate code	Default plate designation	Bottom shape	Bottom height	Dimension name	Plate dimensions
96 wells	439454	Nunc* solid F96	Flat	3.1 mm	Max. overall plate height	14.5 mm ± 0.2 mm
	449824	Nunc U96	U	4.2 mm		14.5 mm ± 0.1 mm
	430341	Nunc C96	C	3.4 mm		14.0 mm ± 0.3 mm
	249662	Nunc V96	V**	4.2 mm		14.5 mm ± 0.1 mm
	441653	Nunc starwell strip plate	Star**	3.6 mm		
					Well-to-well distance	9.0 mm
384 wells	464718	Nunc F384	Flat	2.7 mm	Max. overall plate height	14.4 mm ± 0.25 mm
					Well-to-well distance	4.5 mm

* Thermo Scientific™ Nunc™

** Not valid for a 96-well plate with a 2x8 / 96 (cell wash) wash head.

Steps

You can create or edit the wash protocol in the **Main** menu. It is recommended to test the optimal parameters for each assay before operation.

Steps are listed and numbered in the order of execution. It is possible to add steps to the step list. The maximum number of steps in a protocol is 99.

If there is more than one step in the protocol, the step parameters are not shown on the **Steps** row.

Refer to “Adding new steps to protocols” on page 61 and “Deleting steps from protocols” on page 63.

The following steps are available:

- Wash / Cell wash
- Aspirate / Cell aspirate
- Dispense / Cell dispense
- Soak
- Prime
- Pause
- Layout

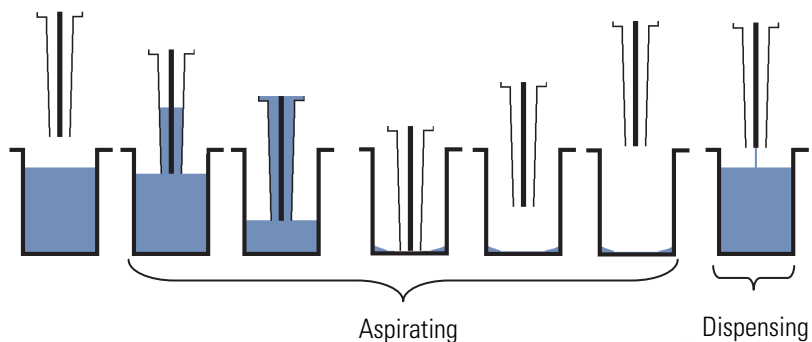

Figure 6-37. Principle of Wash step (Normal)

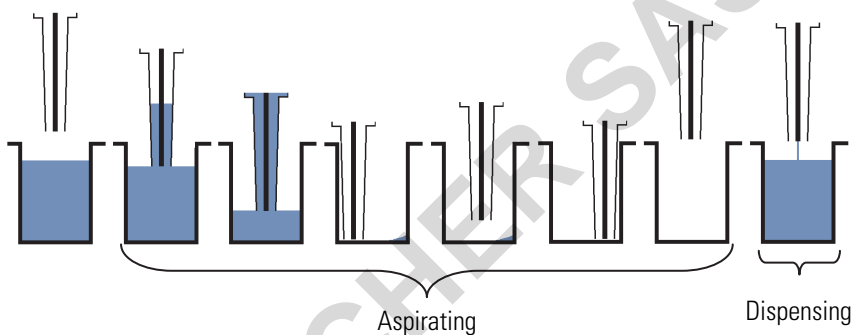

Figure 6-38. Principle of Wash step (Sweep2)

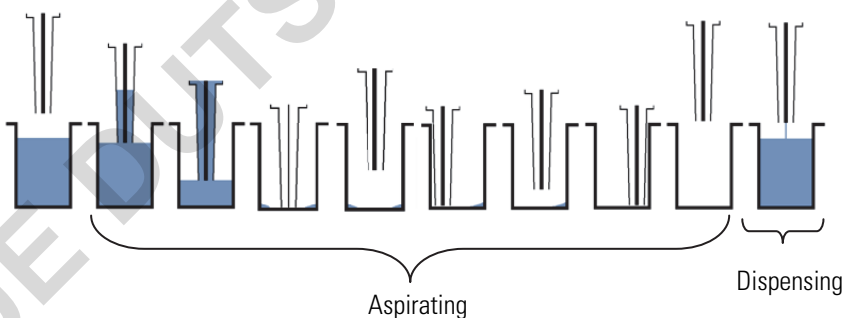

Figure 6-39. Principle of Wash step (Sweep3)

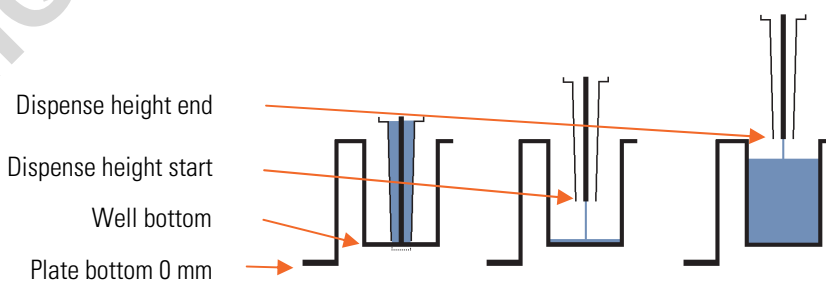
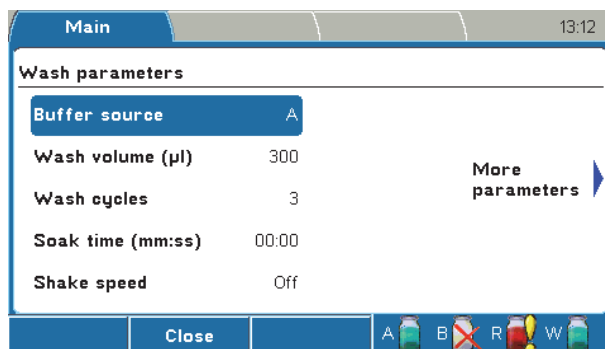

Figure 6-40. Dispense heights

Wash



The wash step is the step needed in most wash protocols. The well is first emptied, then filled with buffer and finally emptied or left full.



The wash parameters are grouped into two windows. Use the **Right** and **Left** arrow keys to move from one window to another.

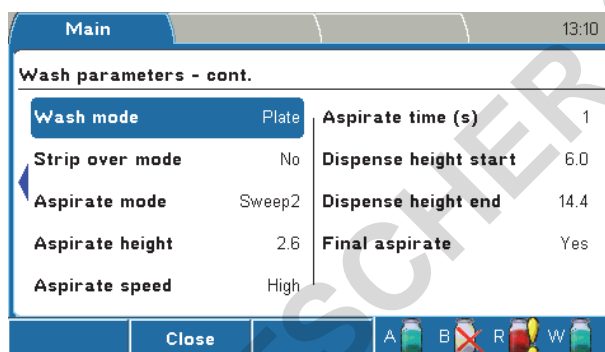

The *Wash* step has the following parameters:

- **Buffer source** – You can define the buffer source channel A, B, or Rinse. The default is *A*.
- **Wash volume (µl)** – Define the volume of the wash buffer used in microplate washing. For a 96-well plate, the range is 50 µl to 1000 µl in 10 µl increments. The default value is *300 µl*.

For a 384-well plate, the range is 20 µl to 300 µl in 10 µl increments. The default value is *100 µl*.



Note It is possible to dispense more than the well volume and the excess liquid is aspirated, as the aspiration is always on. If a so-called overflow volume is selected where the dispensing volume is greater than the well volume, pay attention to the dispense height. Check that the wash head tips are inside the well. ▲

- **Wash cycles** – Define the number of wash cycles that will be performed, from 1 to 10. The default value is *3*.
- **Soak time (mm:ss)** – Define the time period between wash cycles in the Wash step. The default value is *00:00* (= no soak). The minimum value is 0 s and the maximum value 60 min in increments of 1 s.

- **Shake speed** – Define the shake speed Off, Low, Medium, or High. The default is *Off*. The shake speed setting is effective only when the soak time is > 00:00.



Caution Ensure that the liquid does not spill at the shake speed and volume settings in use. ▲

- **Wash mode** – Define the wash mode. The default is *Plate mode*.
 - **Plate** – All selected strips are processed before the next cycle.
 - **Strip** – Each selected strip is processed the number of cycles defined before moving to the next strip.
- **Strip over mode** – Define the strip over function. The default is *No*.
 - **No** – All selected strips are processed as fast as possible.
 - **Yes** – If *Yes* is selected, unused strips are processed dry. The time parameters are measured during the first protocol run. The wash head stays above unused strips for as long as it takes to process each selected strip. This selection is recommended when the timing for washing strips is critical. You can maintain the time between cycles constant with this option. It is recommended to carry out a dummy run before the actual samples. Refer to Figure 6–37.
- **Aspirate mode** – Define the aspiration mode Normal, Sweep 2, or Sweep 3. Sweep is allowed for 96-well plates with flat wells. The default value depends on the wash head type or well shape. Refer to Figure 6–38.
 - **Normal** – There is one aspirate position in the center of the well.
 - **Sweep2** – Aspirates in two different positions across the bottom of the well.
 - **Sweep3** – Aspirates in three different positions across the bottom of the well.
- **Aspirate height** – The aspirate height ranges from 0 mm to 14 mm in 0.1 mm increments. The default height varies according to the plate type and well shape (see Table 6–6 on page 70). The zero height from which the aspirate height is defined is the lowest level of a plate when the plate is properly placed on the plate carrier. Refer to Figure 6–40.



Caution Too high an aspirate height increases the residual volume. ▲



Note The aspirate height determines the amount of residual volume in the wells. If you want the wells entirely empty, move the tips completely to the well bottom or slightly below so that the wash head rests on the bottom of the well. ▲

Table 6–6. Plate and well shape vs. default aspirate height

Plate / Well shape	Default aspirate height
96 / Flat	2.6 mm
96 / C	2.9 mm
96 / U	4.2 mm
96 / V	5.4 mm
96 / Star	3.1 mm
384 / Flat	2.2 mm

Default aspirate heights are defined so that the wash heads rest on the bottom of the well.

- **Aspirate speed** – Define the aspirate rate Low, Medium, or High. The default is *High*.
- **Aspirate time (s)** – The aspirate time ranges from 0 s to 10 s in 1 s increments. The default is *1 s*.
- **Dispense height start** – The dispense height start ranges from 0 mm to 17 mm in 0.1 mm increments. The default is *6.0 mm*. Ensure that the value fits the plate in use. Because dispensing starts from a lower level in a well and ends at a higher level, the start height should be lower than or equal to the end height. Refer to Figure 6–40.
- **Dispense height end** – The dispense height end ranges from 0 mm to 17 mm in 0.1 mm increments. The default is *14.4 mm*. Refer to Figure 6–40.



Note Because aspiration is on during dispensing, the end volume in the well depends on the dispense height. If the liquid level in the well during dispensing reaches the wash head tip, then excess liquid is aspirated. ▲



Note It is possible to dispense more than the well volume and the excess liquid is aspirated, as the aspiration is always on during dispensing. If a so-called overflow volume is selected where the dispense volume is greater than the well volume, ensure that the dispense height end is not outside the well. ▲

- **Final aspirate** – The wells are emptied at the end of the step. The default is *Yes*, which leaves wells empty. *No* leaves the wells wet.

Cell wash



Washing of cells can be carried out in 96-well plates only with a special optional *2x8 / 96 (cell wash)* wash head. The Cell wash step provides a gentler wash than the normal Wash step. Refer to “Wash” on page 67.

Liquid is dispensed dropwise into and aspirated from the well during washing of cells. Offsetting the dispense tips toward the side rather than into the center of the well will dissipate the energy of the fluid stream prior to reaching the cell layer.

When defining the aspiration parameters, it is advisable to leave a residual. The residual fluid will act as a shield to prevent trauma to the cell layer during the subsequent fluid dispense. It also has the added advantage of maintaining cell hydration. The aspirate height has to be set higher than the cell layer. Avoiding aspiration delays is also critical. There is a significant amount of vortex turbulence in the region immediately surrounding the aspiration tips, which has the potential to be quite damaging to the cell layer.

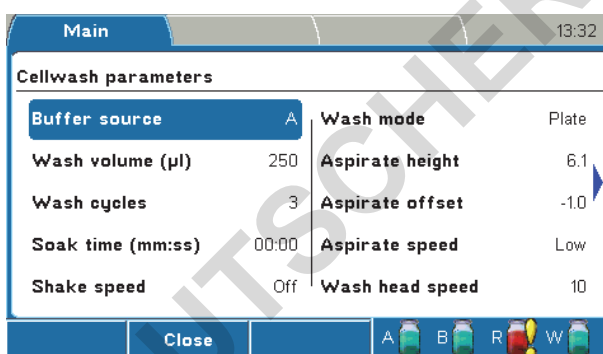

The cell wash parameters are grouped into four columns. Use the **Right** and **Left** arrow keys to move from one column to another.

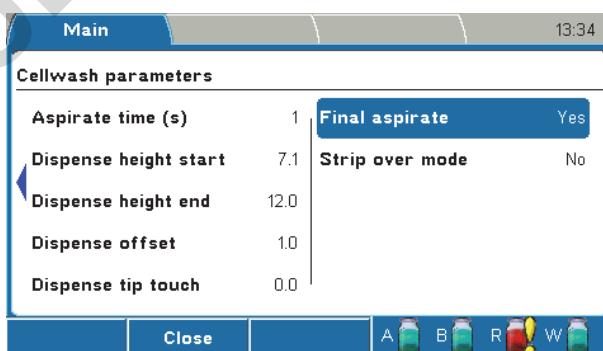

The *Cell wash* step has the following parameters:

- **Buffer source** – Define the buffer source channel A, B, or Rinse. The default is A.
- **Wash volume (µl)** – Define the volume of the wash buffer used in microplate washing. The wash volume range is 50 µl to 1000 µl in 10 µl increments. The default value is 250 µl.



Note It is possible to dispense more than the well volume and the excess liquid is aspirated. If a so-called overflow volume is selected where the dispensing volume is greater than the well volume, the dispense height is affected. That is, it is not possible to lift the wash head too high without aspirating the excess liquid. ▲

- **Wash cycles** – Define the number of wash cycles that will be performed, from 1 to 10. The default value is 3.
- **Soak time (mm:ss)** – Define the time period between wash cycles in the Cell wash step. The default value is 00:00 (= no soak). The minimum value is 0 s and the maximum value 60 min in increments of 1 s.
- **Shake speed** – Define the shake speed Off, Low, Medium, or High. The default is Off. The shake speed setting is effective only when the soak time is > 00:00.



Caution Ensure that the liquid does not spill at the shake speed and volume settings in use. ▲

- **Wash mode** – Define the wash mode. The default is *Plate mode*.
 - **Plate** – All selected strips are processed before the next cycle.
 - **Strip** – Each selected strip is processed the number of cycles defined before moving to the next strip.
- **Aspirate height** – The aspirate height ranges from 0 mm to 14 mm in 0.1 mm increments. The default height varies according to the plate type and well shape (Table 6–7). The zero height from which the aspirate height is defined is the lowest level of a plate when the plate is properly placed on the plate carrier. Refer to Figure 6–40.



Caution Too high an aspirate height increases the residual volume. ▲



Note The aspirate height determines the amount of residual volume in the wells. If you want the wells entirely empty, move the tips completely to the well bottom or slightly below so that the wash head rests on the bottom of the well. ▲

Table 6–7. Plate and well shape vs. default aspirate height

Plate / Well shape	Default aspirate height	
96 / Flat	6.1 mm	Default aspirate heights are defined so that the wash head stays above the bottom. For example, 3.0 mm above the bottom with flat bottom plates.
96 / C	6.1 mm	
96 / U	6.1 mm	

- **Aspirate offset** – Define the aspirate offset from - 1.5 mm to 1.5 mm in 0.1 increments. The default is *-1.0 mm*.
- **Aspirate speed** – Define the aspirate rate Low, Medium, or High. The default is *Low*.
- **Wash head speed** – This speed is used during the last 3 mm before the aspirate height is reached. The wash head speed ranges from 1 mm/s to 10 mm/s in 1 mm/s increments. The default is *10 mm/s*.
- **Aspirate time (s)** – The aspirate time ranges from 0 s to 10 s in 1 s increments. The default is *1 s*.
- **Dispense height start** – The dispense height start ranges from 0 mm to 17 mm in 0.1 mm increments. The default is *7.1 mm*. During dispensing, the wash head starts from a lower level in a well (the so-called dispense height start) and rises towards the dispense height end, as the liquid volume increases. The start height should be lower than or equal to the end height. Ensure that the value fits the plate in use. Refer to Figure 6–40.
- **Dispense height end** – The dispense height end ranges from 0 mm to 17 mm in 0.1 mm increments. The default is *12.0 mm*. Refer to dispense height start above. Refer to Figure 6–40.



Note Because aspiration is on during dispensing, the end volume in the well depends on the dispense height. If the liquid level in the well during dispensing reaches the wash head tip, then excess liquid is aspirated. ▲



Note It is possible to dispense more than the well volume and the excess liquid is aspirated, as the aspiration is always on during dispensing. If a so-called overflow volume is selected where the dispense volume is greater than the well volume, ensure that the dispense height end is not outside the well. ▲

- **Dispense offset** – The dispense offset value changes the wash head position horizontally, enabling a gentle dispensing via the well wall. The dispense offset ranges from - 1.5 mm to 1.5 mm in 0.1 mm increments. The default is *1.0 mm*.



Caution Make sure that the liquid is dispensed into the well. ▲

- **Dispense tip touch** – The dispense tip touch movement is used to remove the last droplet from the wash head tips after the dispensing action. The dispense tip touch ranges from 0.0 mm to 1.5 mm in 0.1 mm increments. The default is *0.0 mm*.
- **Final aspirate** – The wells are emptied at the end of the step. The default is *Yes*, which leaves wells empty. *No* leaves the wells wet.

- **Strip over mode** – Define the strip over function. The default is *No*.
 - **No** – All selected strips are processed as fast as possible.
 - **Yes** – If *Yes* is selected, unused strips are processed dry. The time parameters are measured during the first protocol run. The wash head stays above unused strips for as long as it takes to process each selected strip. This selection is recommended when the timing for washing strips is critical. You can maintain the time between cycles constant with this option.

Aspirate



An Aspirate step removes liquid from the wells.

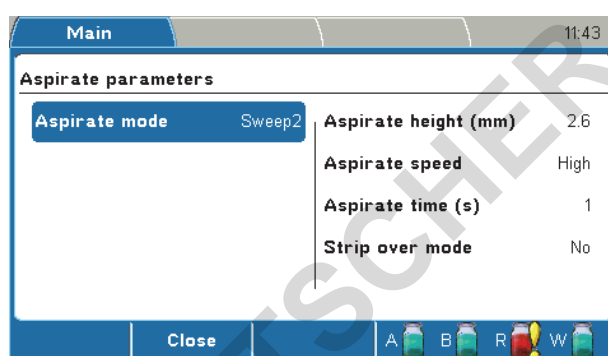

The *Aspirate* step has the following parameters:

- **Aspirate mode** – Define the aspirate mode Normal, Sweep 2, or Sweep 3. The default is *Normal*. Sweep is allowed for 96-well plates with flat wells. Refer to Figure 6–38.
 - **Normal** – There is one aspirate position at the center of the well.
 - **Sweep2** – Aspirates in two different positions across the bottom of the well.
 - **Sweep3** – Aspirates in three different positions across the bottom of the well.
- **Aspirate height (mm)** – The aspirate height ranges from 0 mm to 14 mm in 0.1 mm increments. The default height varies according to the plate type and well shape (see Table 6–6 on page 70). Refer to Figure 6–40.



Caution Too high an aspirate height increases the residual volume. ▲

Note The aspirate height determines the amount of residual volume in the wells. If you want the wells entirely empty, move the tips completely to the well bottom or slightly below so that the wash head rests on the bottom of the well. ▲

- **Aspirate speed** – Define the aspirate rate as Low, Medium, or High. The default is *High* in 96-well format and *Low* in 384-well format.
- **Aspirate time (s)** – The aspirate time ranges from 0 s to 10 s in 1 s increments. The default is *1 s*.



Caution A zero second aspirate time will increase the residual volume. ▲

- **Strip over mode** – Define the strip over function. The default is *No*.
 - **No** – All selected strips are processed as fast as possible.
 - **Yes** – If *Yes* is selected, unused strips are processed dry. The time parameters are measured during the first protocol run. The wash head stays above unused strips for as long as it takes to process each selected strip. This selection is recommended when the timing for washing strips is critical. You can maintain the time between cycles constant with this option.

Cell aspirate



A Cell aspirate step removes liquid from the wells. Refer to “Cell wash” on page 71.

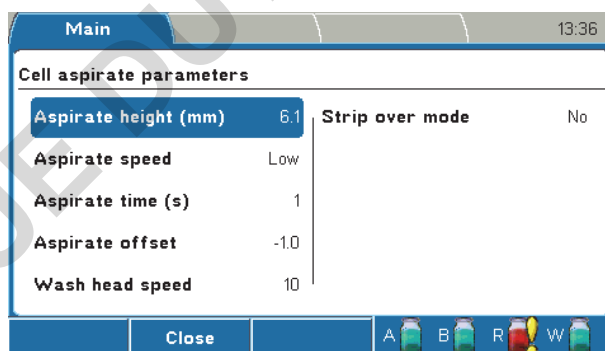

The *Cell aspirate* step has the following parameters:

- **Aspirate height (mm)** – The aspirate height ranges from 0 mm to 14 mm in 0.1 mm increments. The default height varies according to the plate type and well shape (see Table 6–7 on page 72). Refer to Figure 6–40.



Caution Too high an aspirate height increases the residual volume. ▲



Caution Aspirating too low may disrupt the cells or block the channels. ▲

- **Aspirate speed** – Define the aspirate rate Low, Medium, or High. The default is *Low*.

- **Aspirate time (s)** – The aspirate time ranges from 0 s to 10 s in 1 s increments. The default is 1 s.
- **Aspirate offset** – Define the aspirate offset from - 1.5 mm to 1.5 mm in 0.1 mm increments. The default is -1.0 mm.
- **Wash head speed** – This speed is used during the last 3 mm before the aspirate height is reached. The wash head speed ranges from 1 mm/s to 10 mm/s in 1 mm/s increments. The default is 10 mm/s.
- **Strip over mode** – Define the strip over function. The default is *No*.
 - **No** – All selected strips are processed as fast as possible.
 - **Yes** – If *Yes* is selected, unused strips are processed dry. The time parameters are measured during the first protocol run. The wash head stays above unused strips for as long as it takes to process each selected strip. This selection is recommended when the timing for washing strips is critical. You can maintain the time between cycles constant with this option.

Dispense

A Dispense step fills the wells with liquid.

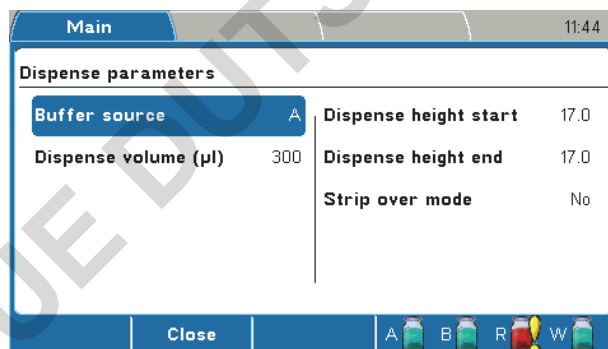

The *Dispense* step has the following parameters:

- **Buffer source** – Define the buffer source channel A, B, or Rinse. The default is *A*.
- **Dispense volume (µl)** – For a 96-well plate, the dispense volume range is 50 µl to 400 µl in 10 µl increments and the default value 300 µl.

For a 384-well plate, the dispense volume range is 20 µl to 120 µl in 10 µl increments and the default value 100 µl.

- **Dispense height start** – The dispense height start ranges from 0 mm to 20 mm in 0.1 mm increments. The default is 17.0 mm. Ensure that the value fits the plate in use. Because dispensing starts from a lower level in a well and ends at a higher level, the start height should be lower than or equal to the end height. Refer to Figure 6–40.

- **Dispense height end** – The dispense height end ranges from 0 mm to 20 mm in 0.1 mm increments. The default is *17.0 mm*. Refer to Figure 6–40.



Note Because aspiration is on during dispensing, the end volume in the well depends on the dispense height. If the liquid level in the well during dispensing reaches the wash head tip, then excess liquid is aspirated. ▲

- **Strip over mode** – Define the strip over function. The default is *No*.
 - **No** – All selected strips are processed as fast as possible.
 - **Yes** – If *Yes* is selected, unused strips are processed dry. The time parameters are measured during the first protocol run. The wash head stays above unused strips for as long as it takes to process each selected strip. This selection is recommended when the timing for washing strips is critical. You can maintain the time between cycles constant with this option.

Cell dispense



A Cell dispense step fills the wells with liquid dropwise. Refer to “Cell wash” on page 71.

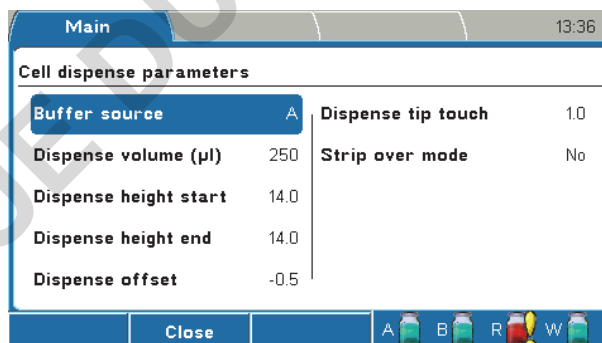

The *Cell dispense* step has the following parameters:

- **Buffer source** – Define the buffer source channel A, B, or Rinse. The default is *A*.
- **Dispense volume (µl)** – The dispense volume range is 50 µl to 400 µl in 10 µl increments. The default value is *250 µl*.
- **Dispense height start** – The dispense height start ranges from 0 mm to 20 mm in 0.1 mm increments. The default is *14.0 mm*. Ensure that the value fits the plate in use. Because dispensing starts from a lower level in a well and ends at a higher level, the start height should be lower than or equal to the end height. Refer to Figure 6–40.

- **Dispense height end** – The dispense height end ranges from 0 mm to 20 mm in 0.1 mm increments. The default is *14.0 mm*. Refer to Figure 6–40.



Note Because aspiration is on during dispensing, the end volume in the well depends on the dispense height. If the liquid level in the well during dispensing reaches the wash head tip, then excess liquid is aspirated. ▲

- **Dispense offset** – The dispense offset value changes the wash head position horizontally, enabling a gentle dispensing via the well wall. The dispense offset ranges from - 1.5 mm to 1.5 mm in 0.1 mm increments. The default is *- 0.5 mm*.
- **Dispense tip touch** – The dispense tip touch movement is used to remove the last droplet from the wash head tips after the dispensing action. The dispense tip touch ranges from 0.0 mm to 1.5 mm in 0.1 mm increments. The default is *1.0 mm*.
- **Strip over mode** – Define the strip over function. The default is *No*.
 - **No** – All selected strips are processed as fast as possible.
 - **Yes** – If *Yes* is selected, unused strips are processed dry. The time parameters are measured during the first protocol run. The wash head stays above unused strips for as long as it takes to process each selected strip. This selection is recommended when the timing for washing strips is critical. You can maintain the time between cycles constant with this option.

Soak



During a Soak step the liquid remains in the wells for the set time with or without shaking of the plate.

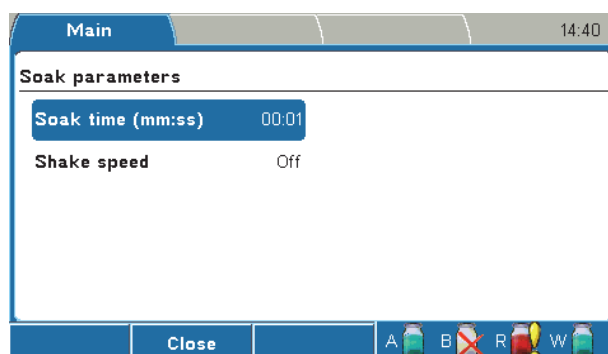

The *Soak* step has the following parameters:

- **Soak time (mm:ss)** – Define the time period between a wash cycle in microplate wash protocols. The minimum value is 0 s and the maximum value 60 min in increments of 1 s. The default value is *00:01*.
- **Shake speed** – Define the shake speed Off, Low, Medium, or High. The default is *Off*. The shake speed setting is only effective when the soak time is > *00:00*.



Caution Ensure that the liquid does not spill at the shake speed and volume settings in use. ▲



Caution The instrument is not intended for shaking purposes only. A separate microplate shaker is available if needed (e.g. iEMS Incubator/Shaker). Refer to www.thermoscientific.com. ▲

Prime



The Prime step is performed to fill the liquid tubing completely from the selectable buffer bottle intake tube to the wash head tips. A protocol should have a Prime step before each buffer is used to ensure that the liquid tubing is filled correctly with the desired liquid before performing any Wash or Dispense steps.

The default priming volume is *30 ml* in order to fill the tubing properly. The dead volume of the liquid tubing is 20 ml (Figure 5-34).



Note Avoid unnecessary priming with air because it may damage the pump. ▲

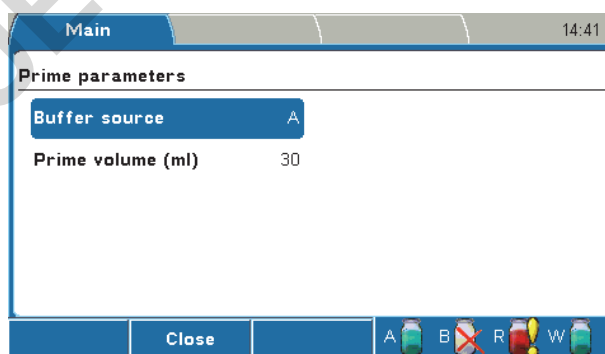

The *Prime* step has the following parameters:

- **Buffer source** – Define the buffer source channel A, B, or Rinse. The default is *A*.
- **Prime volume (ml)** – The prime volume ranges from 5 ml to 100 ml in 5 ml increments. The default is *30 ml*.

Priming is carried out in the priming position. Aspiration is on while priming. At the end, the priming vessel is emptied and the wash head returns to the home position.

Pause



You can stop a protocol momentarily and then start the protocol again.

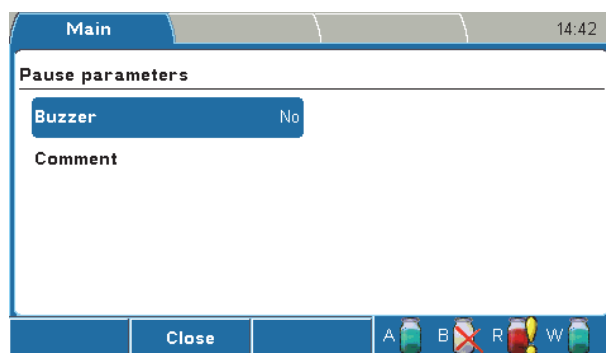

The *Pause* step has the following parameters:

- **Buzzer** – Set the buzzer on (= Yes) or off (= No). There is a beep when the Pause step starts. The default is *No*.
- **Comment** – You can add text, for example, instructions. There is space for 128 characters.

To end the Pause step, press the **OK** button to continue protocol execution. A three-second alarm is sounded.

Layout

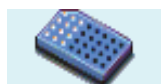

The *Layout* step is used to predefine the strip selection for a protocol. This step determines the area on which the next steps are processed.

The layout is *landscape* when a 1x8, 2x8, or 1x16 wash head is selected and *portrait* for a 1x12 or 2x12 wash head. The strips are numbered 1–12 if an nx8 wash head is used and marked A–H for an nx12 wash head. The strips are numbered 1–24 if a 1x16 wash head is used.

If there is no Layout step in the protocol, the processed area is according to the Main > **Layout** row selection.



Note Only the strips that are selected to the Layout step are saved with the protocol. Strips selected using the **Layout** row are not saved. ▲

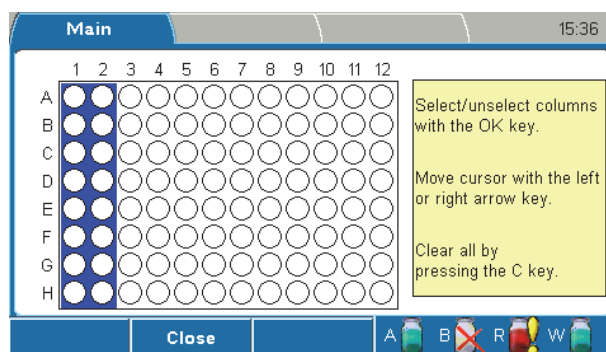

The selected strips are highlighted with **red** color.

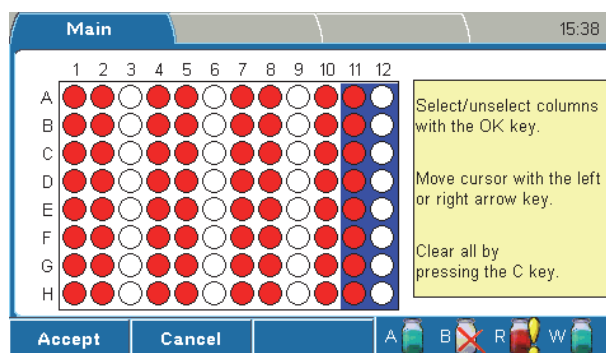

Note If the Layout step is the first step in the protocol, the selected wells are shown in **blue** on the **Layout** row in the **Main** menu. The **Layout** row is then *locked*. ▲

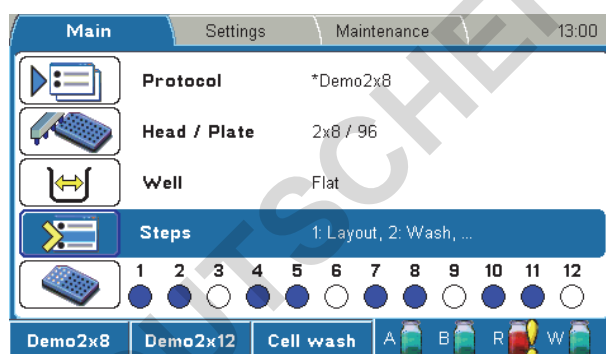

If the Layout step is used, it is recommended to use the step as the first step in the protocol. If the Layout step is not the first step in the protocol, the **Layout** row is not locked but enabled. You can select strips using the row until the first Layout step in the protocol is encountered.

Settings menu

The Settings menu contains the **Prime & rinse parameters**, **Sensors**, **Wash head configuration**, **System**, and **Reports** parameters.



Prime & rinse parameters

The prime and rinse parameters can be set in the **Prime & rinse parameters** window.



Select the **Prime & rinse parameters** row in the **Settings** menu and press the **OK** button.

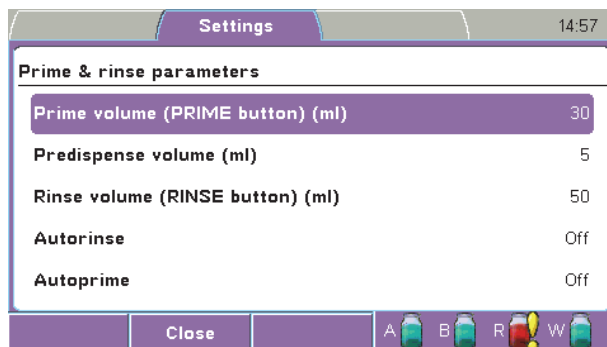

Warning If you activate the **Autorinse** or **Autoprime** parameter, ensure that the wash heads are firmly attached. Failure to do so may result in spillage. ▲

The **Prime & rinse parameters** window has the following parameters:

- **Prime volume (Prime button) (ml)** – The prime volume ranges from 5 ml to 100 ml in 1 ml increments. The default is *30 ml*.
- **Predispense volume (ml)** – This volume is dispensed before the start of each dispensing to ensure accurate dispensing. The predispense volume ranges from 1 ml to 20 ml in 1 ml increments or it can be set Off. The default is *5 ml*.
- **Rinse volume (Rinse button) (ml)** – The rinse volume ranges from 5 ml to 100 ml in 1 ml increments. The default is *50 ml*.
- **Autorinse** – The washer can be programmed to rinse the system automatically using the rinse liquid with a selected volume. At the end of the run, the software starts to count down the selected time. Thirty seconds before the autorinse starts, the buzzer gives an audible sound and the remaining time is shown on the display. When the time reaches zero, rinsing starts.
 - **Volume (ml)** – The autorinse volume ranges from 5 ml to 100 ml in 1 ml increments. The default is *50 ml*.
 - **Time (hh:mm)** – The times range is from 00:00 (= Off) to 12:00 in increments of 15 min. The default is *Off*.



Note that the **blue** clock icon appears on the menu bar when **Autorinse** or **Autoprime** is active.

- **Autoprime** – This primes the instrument at a set interval to ensure that the instrument stays primed. Autoprime is not recommended for long time intervals (overnight). Use instead the Soak wash head function. Refer to “Soak wash head” on page 92.

- **Volume (ml)** – The autopriming volume ranges from 1 ml to 30 ml in 1 ml increments. The default is 5 ml.
- **Time (hh:mm)** – The time ranges from 0:00 (= Off) to 9:00 in increments of 15 min. The default is Off.

Sensors

Liquid level sensors are built into the caps of all bottles to avoid overflow of the waste bottle and to warn the user when the buffer bottles are almost empty.

The liquid level sensors can be enabled or disabled in the **Sensors** window.



Caution If the sensors are disabled, there will be no warning prior to the buffer bottle being empty or the waste bottle full. Failure may result in a weakened or faulty wash result, liquid spillage, or biohazard. ▲



Select the **Sensors** row in the **Settings** menu and press the **OK** button.



The **Sensors** window has the following parameters:

- **Buffer A sensor** – Disable or enable the buffer A sensor. The default is *Enabled*.
- **Buffer B sensor** – Disable or enable the buffer B sensor. The default is *Enabled*.
- **Buffer Rinse sensor** – Disable or enable the buffer Rinse sensor. The default is *Enabled*.
- **Buffer Waste sensor** – Disable or enable the buffer Waste sensor. The default is *Enabled*.
- **Plate sensor** – Disable or enable the Plate sensor. The default is *Enabled*. When enabled, the instrument checks whether there is a plate on the plate carrier at the beginning of the protocol run.



Caution If the plate sensor is disabled, there will not be a warning indicating a missing plate. A missing plate may result in spillage. ▲

Wash head configuration

You must always set the wash head configuration to correspond to the physically installed wash head. Refer to “Head / Plate” on page 63.



Select the **Wash head configuration** row in the **Settings** menu and press the **OK** button.

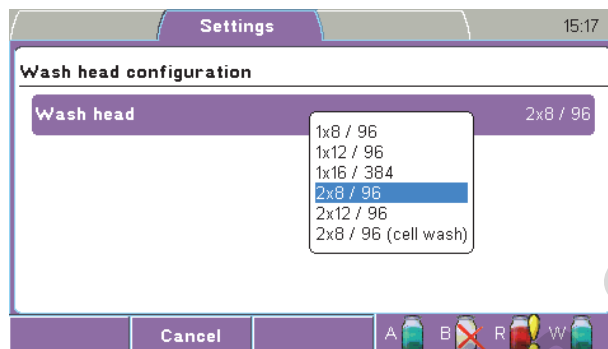

The **Wash head configuration** window has the following parameters:

- **Wash head** – Ensure that the installed wash head is the same as set in the **Wash head configuration** window. Press the **OK** button to select the correct wash head from the list:
 - 1x8 / 96
 - 1x12 / 96
 - 1x16 / 384
 - 2x8 / 96
 - 2x12 / 96
 - 2x8 / 96 (cell wash)



Warning An incorrect wash head configuration can cause liquid spillage or a faulty washing performance. ▲



Warning If the error message shown below appears, calibrate the wash head before use. ▲

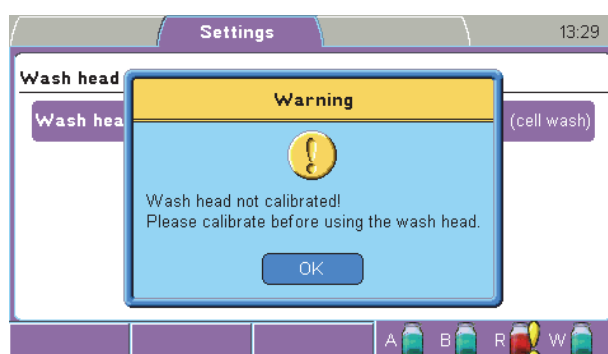

System The system parameters are set in the **System** window.



Select the **System** row in the **Settings** menu and press the **OK** button.

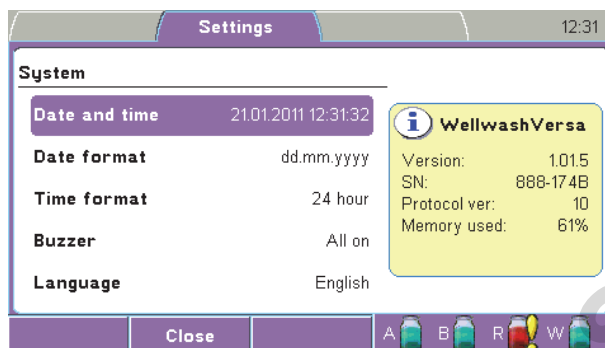

The **System** window has the following parameters:

- **Date and time** – The date and time is set in the *dd.mm.yyyy hh:mm:ss* format.
- **Date format** – Select the date format *dd-mm-yyyy*, *dd/mm/yyyy*, *dd.mm.yyyy*, *yyyy-mm-dd*, or *mm/dd/yyyy*. The default is *dd.mm.yyyy*.
- **Time format** – Select the time format 12 hour or 24 hour. The default is *24 hour*.
- **Buzzer** – Disable or enable the buzzer. The alternatives are All on, Keyb off, or All off. All the warning signals are off in All off. The default is *Enabled* and *All on*.
- **Language** – Set the preferred user interface language. The default is *English*.
 - English
 - 中文 (= Chinese)
 - Français (= French)
 - Deutsch (= German)
 - 日本語 (= Japanese)
 - Português (= Portuguese)
 - Русский (= Russian)
 - Español (= Spanish)
 - Italiano (= Italian)

The following information is also visible in the **System** window:

- **Version:** – Version of the software
- **SN:** – Serial number of the instrument

- **Protocol ver:** – Version of the protocol parameter set. For the best compatibility, ensure that the protocols are of the same version.
- **Memory used:** – The amount of protocol memory that is in use as a percentage of total memory.

Reports

You can export the available reports to a USB memory device for viewing, printing, or saving.

To export a report, attach a USB memory device to the USB memory device port in the instrument, select the desired report and press the **OK** button. The selected report is exported to the USB memory device under an automatically generated folder named “*WELLWASH*”.

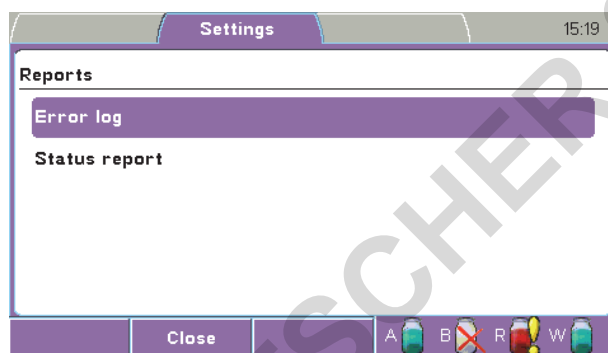

The reports available are:

- **Error log** – The error log shows the date and time of the error and the error(s).
- **Status report** – The status report shows the following parameters: report name, date and time, instrument name, version and serial number, current protocol, prime and rinse parameters, sensor settings and status, wash head configuration, system settings, calibration parameters for all wash heads, offset values, and pump usage hours.

Maintenance menu

You can perform the maintenance procedures in the **Maintenance** menu.

The **Maintenance** menu contains the **Clean**, **Calibration**, and **Service** parameters.

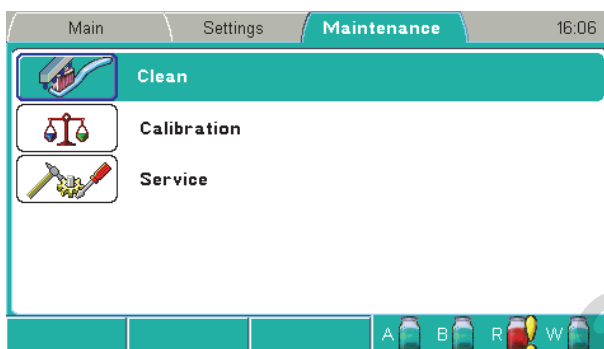

Clean

Cleaning and disinfection procedures are set in the **Clean** window.

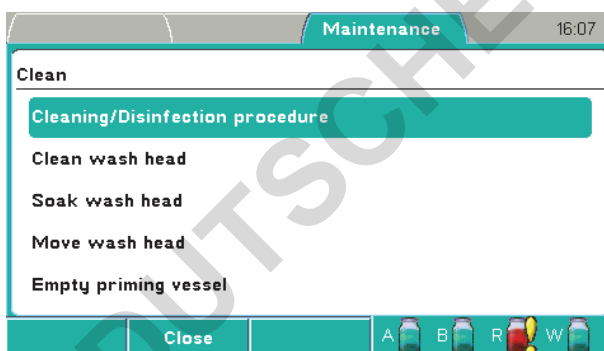

The **Clean** window has the following parameters:

- **Cleaning/Disinfection procedure** (see “Cleaning/Disinfection procedure” on page 87)
- **Clean wash head** (see “Clean wash head” on page 90)
- **Soak wash head** (see “Soak wash head” on page 92)
- **Move wash head** (see “Move wash head” on page 93)
- **Empty priming vessel** (see “Empty priming vessel” on page 94)

Cleaning/Disinfection procedure

The procedure cleans or disinfects the instrument according to a set of actions. Refer to Chapter 11: “*Maintenance*”, particularly “Decontamination procedure” on page 122.

To clean or disinfect the instrument:



1. Press the **OK** button on the **Cleaning/Disinfection procedure** row.

Menus, Tabs and Parameters

Maintenance menu

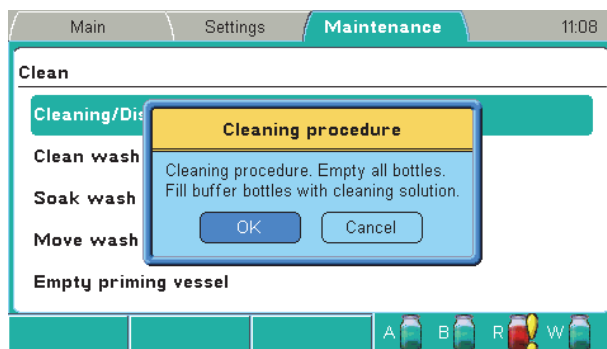

2. Empty all bottles and fill the buffer bottles with cleaning reagent. Press the **OK** button.

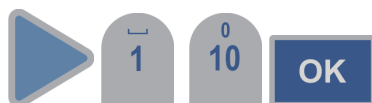
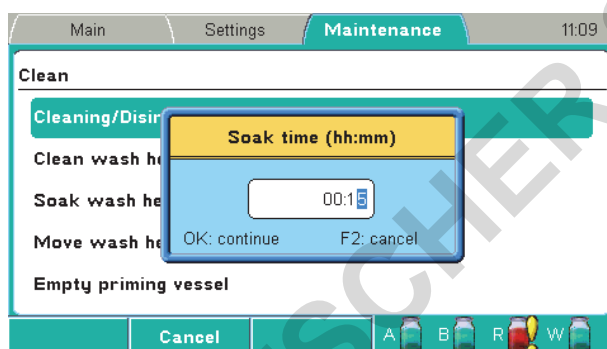

3. Select the soak time using the **Right** arrow key and number keys. The default is *15 min.* Press the **OK** button. Priming, preparing the soak and soaking take place.

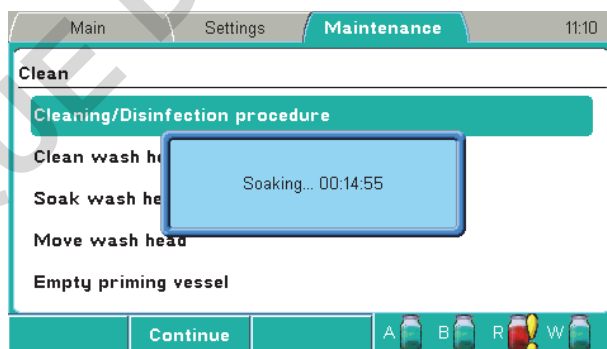

4. Press the **F2** key to abort the soaking if you want a shorter soak time than the set soak time and to continue the procedure. Priming is then carried out.

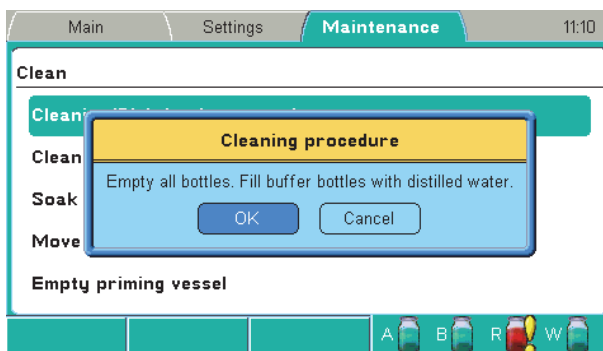

5. Empty all bottles and fill them with deionized distilled water. Press the **OK** button.
Priming, preparing the soak and soaking take place. The default soak time is 2 s. Finally the priming vessel is emptied.

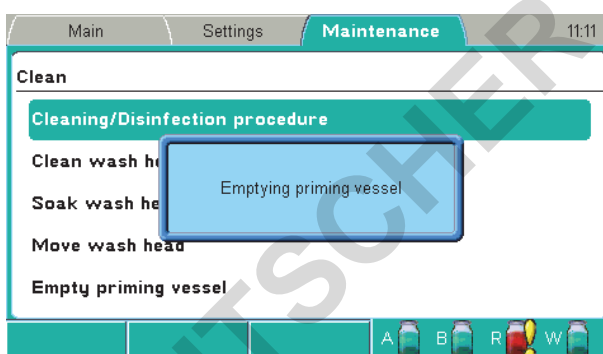

6. Empty all bottles and press the **OK** button.
Priming is then carried out.

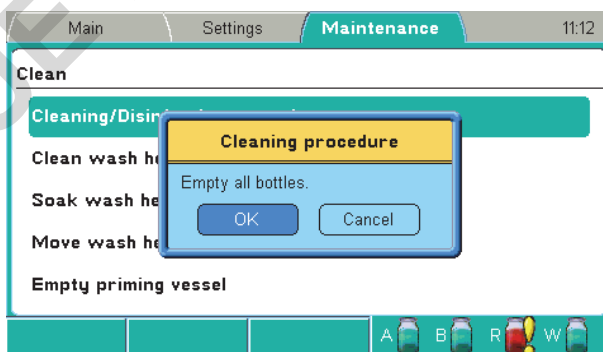

7. Press the **OK** button when the procedure has finished.

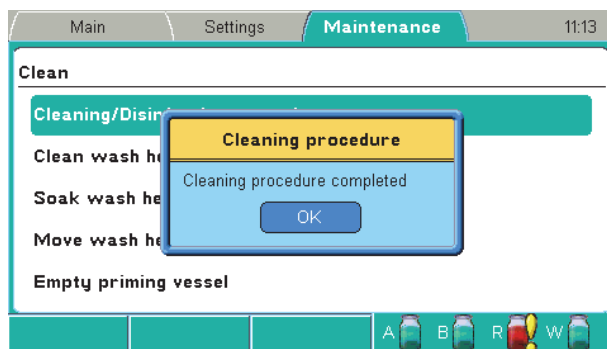

Clean wash head

The procedure cleans the wash head according to a set of actions. Carry out this procedure if the wash heads are dirty or clogged.

The instrument fills the priming vessel with a selected liquid and soaks the wash head for a selected period of time.



Note Use a suitable cleaning agent and repeat the *Clean* procedure with deionized distilled water. ▲



1. Select the **Clean wash head** row and press the OK button.

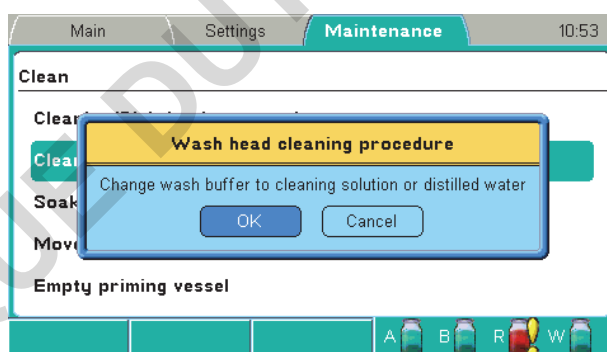

2. Change the wash buffer to cleaning agent or deionized distilled water. Press the **OK** button.

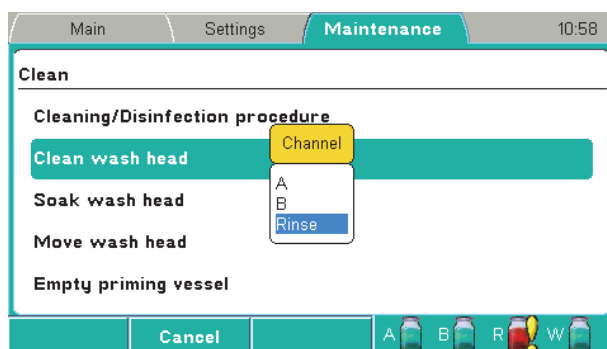



3. Select the priming channel using the **Down** arrow key and/or press the **OK** button.

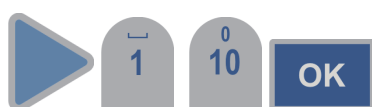
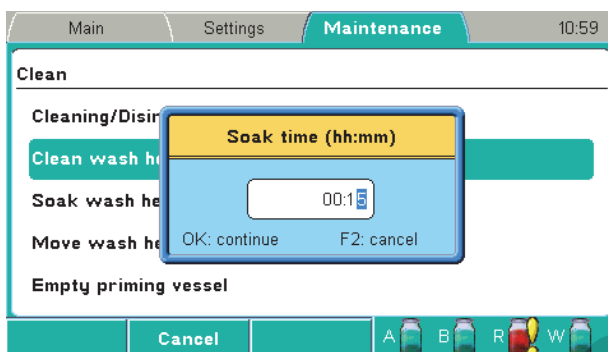

4. Select the soak time using the **Right** arrow key and number keys. The default is *15 min*. Press the **OK** button. Priming, preparing the soak and soaking take place.

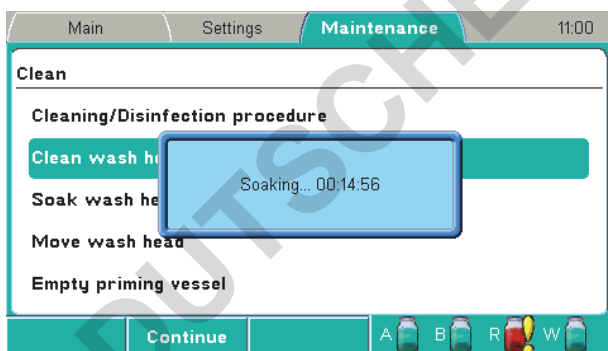

5. Press the **F2** key to stop the soaking if you want a shorter soak time than the set soak time and to continue the procedure. Priming is then carried out.

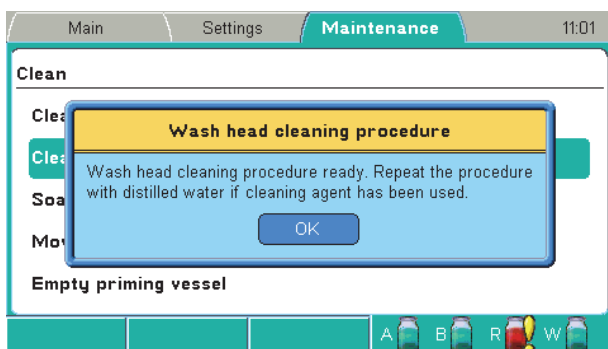

6. Press the **OK** button when the procedure has finished. Repeat the wash head cleaning procedure with deionized distilled water if cleaning agent has been used.

Soak wash head

The procedure soaks the wash head according to a set of actions. The wash head is soaked in liquid (standby) to prevent clogging. The instrument fills the priming vessel with a selected liquid and leaves the wash head immersed in the solution. This procedure can be used for a shorter period of time between washes using a wash buffer or to soak for an extended period, for example, overnight, using deionized distilled water (Rinse channel).



1. Select the **Soak wash head** row using the **Down** arrow key and press the **OK** button.

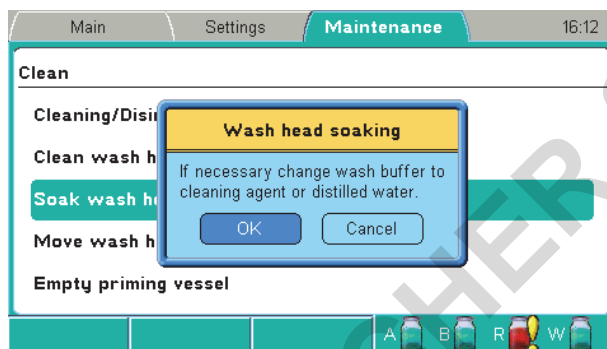

2. Change the wash buffer to cleaning agent or deionized distilled water if needed. Press the **OK** button.

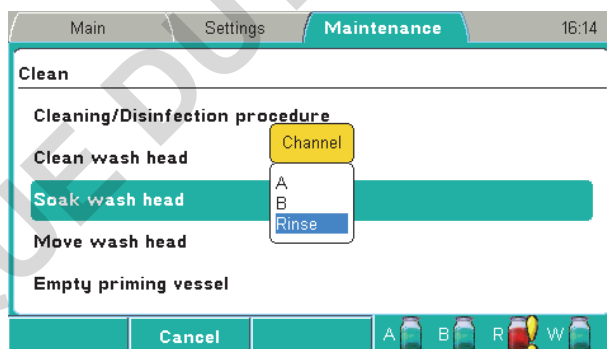

3. Select the priming channel using the **Down** arrow key and/or press the **OK** button.
Priming, preparing the soak and soaking take place.

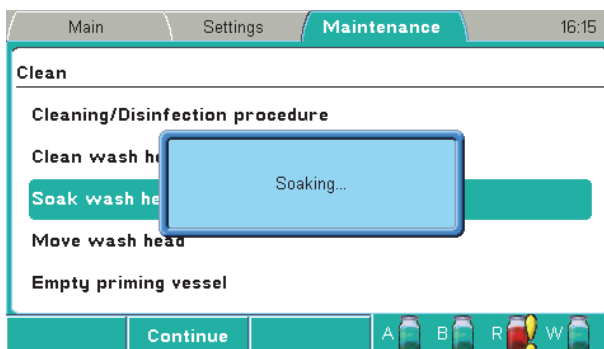

4. Press the **F2** key to abort the soaking and to continue the procedure.
The priming vessel is emptied.

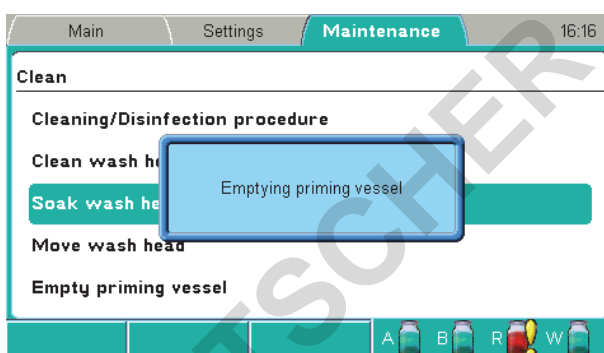

5. Press the **OK** button when the procedure has finished.

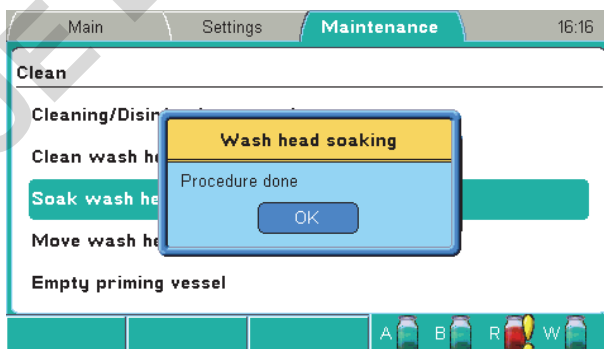

Move wash head

The procedure moves the wash head down into the priming vessel to the soak position. You need to add deionized distilled water or a suitable cleaning agent manually into the priming vessel.

This procedure can be used to leave the wash head in liquid (standby) or when a clogged wash head is cleaned and the instrument pump cannot be used to fill the priming vessel.



1. Select the **Move wash head** row using the **Down** arrow key and press the **OK** button.

Menus, Tabs and Parameters

Maintenance menu

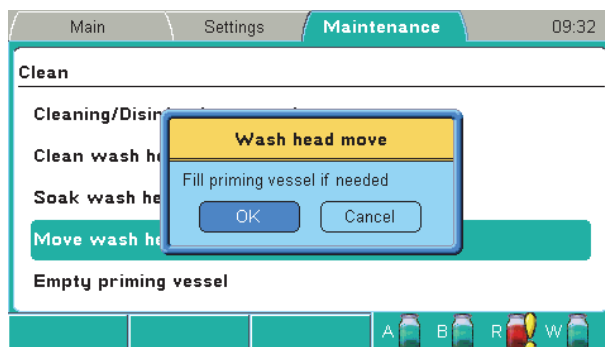

2. Fill the priming vessel manually if needed. Press the **OK** button. Preparing to soak and soaking take place.

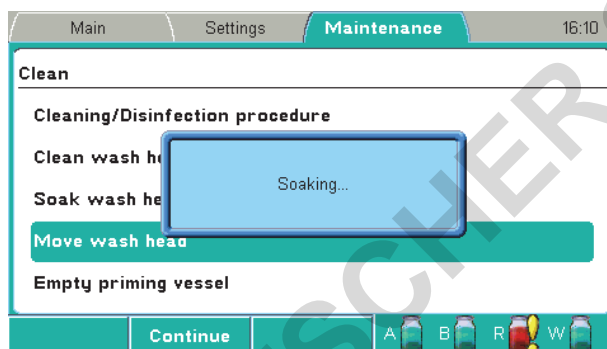

3. Press the **F2** key to end the procedure.



4. Press the **OK** button when the procedure has finished.

Empty priming vessel

The procedure aspirates the priming vessel empty of liquid. The procedure can be carried out, for example, after the *Move wash head* procedure. Refer to “Move wash head” on page 93.



1. Select the **Empty priming vessel** row using the **Down** arrow key and press the **OK** button.

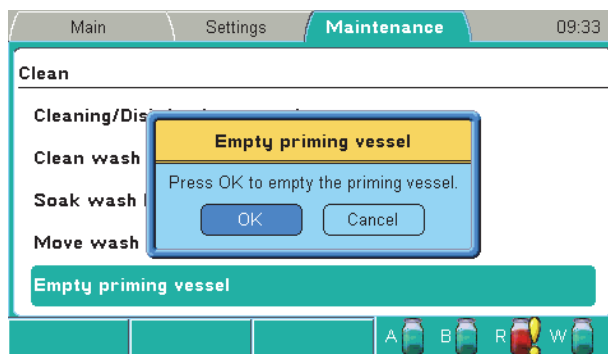

2. Press the **OK** button to empty the priming vessel.
The priming vessel is emptied.



3. Press the **OK** button when the procedure has finished.

Calibration

The wash head supplied with the instrument is calibrated during production. The wash head box includes an instrument serial number to which it has been calibrated. Refer to “Active calibration” on page 97.

Ensure that the wash head type corresponds to the wash head setting in the **Settings** menu. Each wash head type has its own calibration.



Note An optional wash head must be calibrated by the user. ▲



Note It is recommended to check the dispense accuracy regularly and calibrate if necessary. Refer to Chapter 11: “*Maintenance*”. ▲



Note After the calibration procedure, verify the accuracy by dispensing the required volume onto a plate. ▲

Required tools:

- Calibrated laboratory scale with 0.0001 g resolution
- 4+1 96-well plates
- Approximately 500 ml of liquid

The purpose of the calibration is to calibrate the liquid system to dispense accurate volumes. Refer to Figure 3–27, Liquid system diagram. The instrument controls the dispensed volume by adjusting the dispense pump speed and valve open time.

Calibration is performed at 100 µl and 300 µl. The weighed liquid mass of each plate is entered into the Weight fields in the table in grams. The software calculates the internal values of the mean volume per well and

the accuracy % for reference use only. The instrument uses linear regression to calculate the dispense valve open time versus volume.

Starting the calibration



Note Ensure that the wash head type corresponds to the wash head setting in the **Settings** menu. ▲



Note Before running the calibration, make sure that the liquid system operates correctly, for example, that the liquid filters and wash head tips are clean. ▲



Select the **Calibration** row in the **Maintenance** menu and press the **OK** button.



The following calibrations are available:

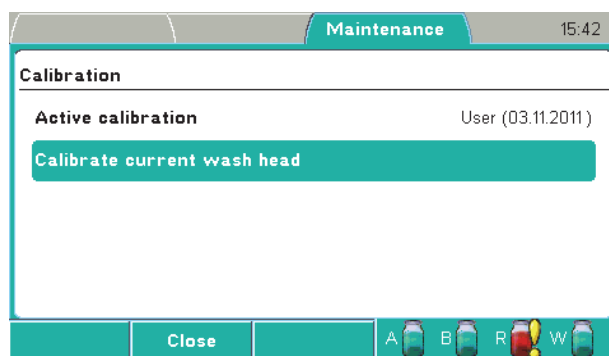

Active calibration

- **Factory** – For service purposes only. This can only be temporarily activated and is active until the power is switched off.
- **User** – The date of the last calibration is shown, initially the date of the calibration in production.

Calibrate current wash head

The calibration is used for calibrating the wash head.



Note A new wash head of the same kind must be calibrated before use. ▲

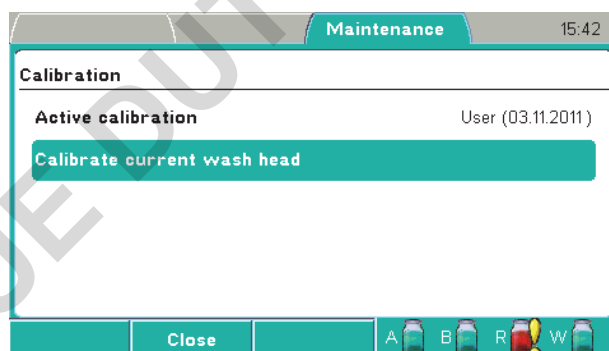

1. Select the **Calibrate current wash head** row and press the OK button.

Menus, Tabs and Parameters

Maintenance menu

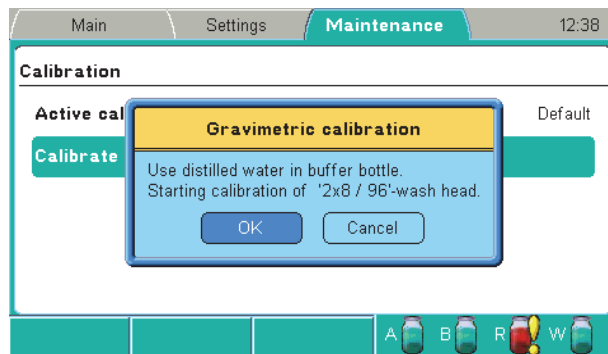

2. Press the **OK** button to start the calibration of the wash head.

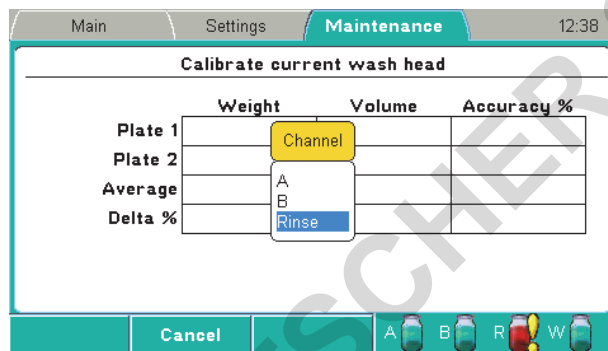

3. Select the used channel using the **Up** arrow key and/or press the **OK** button.

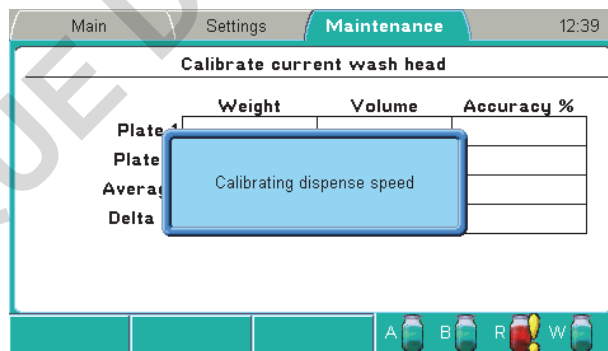

4. The dispense pump is calibrated first.

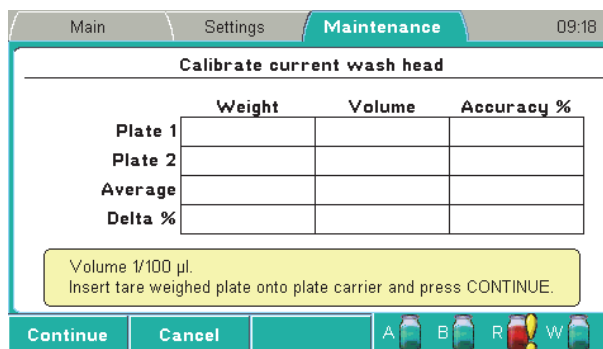

5. Insert the first tare weighed plate onto the plate carrier and press the **F1** key to continue. Dispensing is carried out.

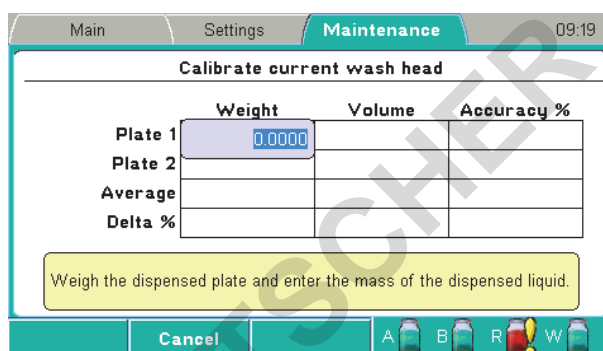

6. Weigh the dispensed plate and enter the mass of the dispensed liquid in grams using the number keys.

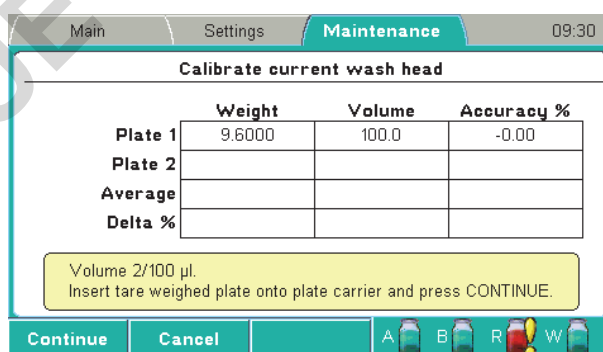

7. Insert the second tare weighed plate onto the plate carrier and press the **F1** key to continue. Dispensing is carried out.

Menus, Tabs and Parameters

Maintenance menu

	Weight	Volume	Accuracy %
Plate 1	9.6000	100.0	-0.00
Plate 2	0.0000		
Average			
Delta %			

Weigh the dispensed plate and enter the mass of the dispensed liquid.



8. Weigh the dispensed plate and enter the mass of the dispensed liquid in grams using the number keys.

	Weight	Volume	Accuracy %
Plate 1	9.6000	100.0	-0.00
Plate 2	9.6000	100.0	-0.00
Average	9.6000	100.0	-0.00
Delta %	0.0000		

Press CONTINUE.



9. Press the **F1** key to continue calibration.
OR
Press the **F2** key to cancel calibration.
OR
Press the **F3** key to repeat calibration when the software informs that the Delta% or accuracy are not acceptable. (The accuracy of the first plate must be $\pm 50\%$ and that of the second plate must be $\pm 5\%$.)

	Weight	Volume	Accuracy %
Plate 1			
Plate 2			
Average			
Delta %			

Volume 1/300 µl.
Insert tare weighed plate onto plate carrier and press CONTINUE.

10. Continue dispensing and weighing the third and fourth plate in the same way.

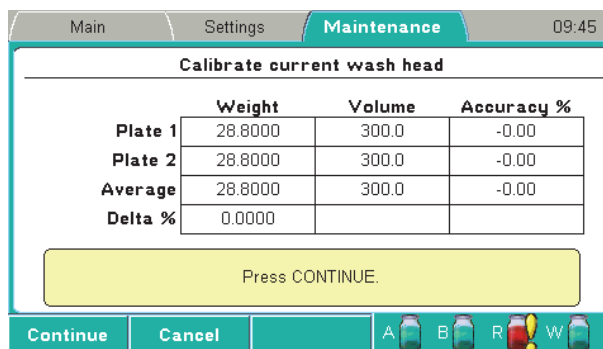

11. Press the **F1** key to continue calibration.
OR
Press the **F2** key to cancel calibration.
OR
Press the **F3** key to repeat calibration when the software informs that the Delta% or accuracy are not acceptable. (The accuracy must be 2.5–3.5 x that of 100 µl.)

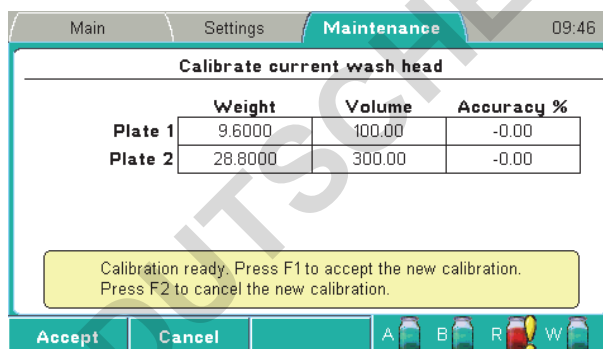

12. Calibration is now complete. Press the **F1** key to accept the new calibration.



Note Calibration for the wash head is saved and it becomes the active calibration. ▲



13. Press the **OK** button when the procedure has finished.

14. Verify the new performance by dispensing a plate, for example, with 300 µl. Tare weigh the plate, dispense and measure the weight to determine the actual dispensed volume.
Calculation method: $\text{Weight [mg]} / 96 = \text{Volume/well [}\mu\text{l]}$

Service Service procedures are set in the **Service** window.

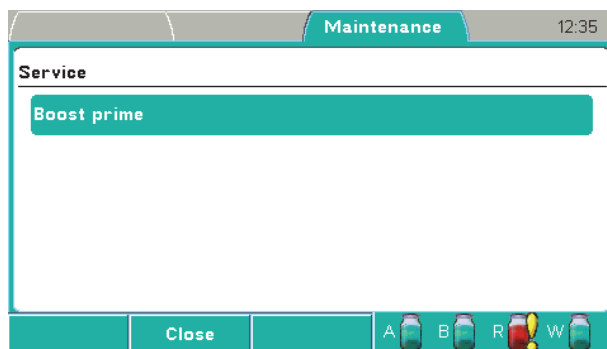

The **Service** window has the following parameter:

- **Boost prime** – Use the Boost prime option when the washer unit has not been used for a long time or when no liquid enters the tubing during priming. Ensure that the buffer bottle A is filled completely.



Warning There is a risk of liquid spillage if Boost prime is not stopped when liquid starts to flow and reaches the wash head. Use only 2x8 or 2x12 wash heads. Do not use other wash heads for boost priming. ▲



Note The liquid level sensors must be enabled (Settings > **Sensors**) to allow boost priming. Refer to “Sensors” on page 83. ▲



Note Attempt the Prime function before performing the Boost prime option. Refer to “Priming the system” on page 47. ▲



Start the Boost prime option by pressing the **OK** button. The pump speed is increased in steps to the maximum speed. To prevent splashing, press the **OK** button or the **STOP** button to interrupt the sequence when liquid starts to flow in the tubing. Continue with the normal Prime operation. Empty the priming vessel (Maintenance > Clean > **Empty priming vessel**) if needed.

If there is still no liquid flowing, refer to “Manual priming” on page 121.

Chapter 7

Exporting and Importing

It is possible to export and import the stored protocols to or from one instrument to another of the same type.

Exporting a protocol

To export a protocol from the instrument to a USB memory device:

1. Insert the USB memory device (Figure 7–41).



Figure 7–41. USB memory device inserted



2. Select the **Protocol** row in the **Main** menu and press the **OK** button. The list of protocols appears.

Protocol:	Head:	Well:	Modified:
Create new protocol			
Cell wash	2x8 / 96 (cell..	Flat	20.01.2011 16:10
Demo1	1x8 / 96	Flat	26.04.2010 11:38
Demo1x12	1x8 / 96	Flat	21.01.2011 15:53
Demo1x8	1x8 / 96	Flat	21.01.2011 15:51
Demo2	1x8 / 96	Flat	26.04.2010 11:40
Demo2x12	2x12 / 96	Flat	20.01.2011 16:07
Demo2x8	2x8 / 96	Flat	20.01.2011 16:05
Demo3	1x8 / 96	Flat	26.04.2010 11:44



3. Select the protocol you want to export.

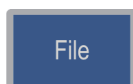

4. Press the **FILE** key to open the **File** menu.

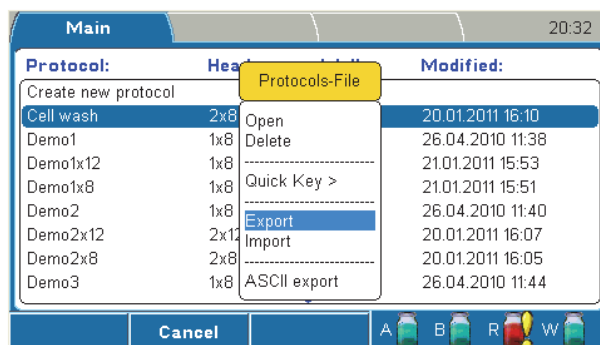

5. Select **Export** and press the **OK** button.

The protocol is exported to the USB memory device under an automatically generated folder named “*WELLWASH*”. The file extension of an exported protocol is *.PRO*. The file is in binary format. You can export protocols one at a time.

Ensure that exporting overwrites the protocol if it already exists on the USB memory device.

When importing, ensure that the same protocol name is not used.

Importing a protocol

To import a protocol from a USB memory device to the instrument:

1. Insert the USB memory device (Figure 7–41).



2. Select the **Protocol** row in the **Main** menu and press the **OK** button. The list of protocols appears.

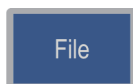
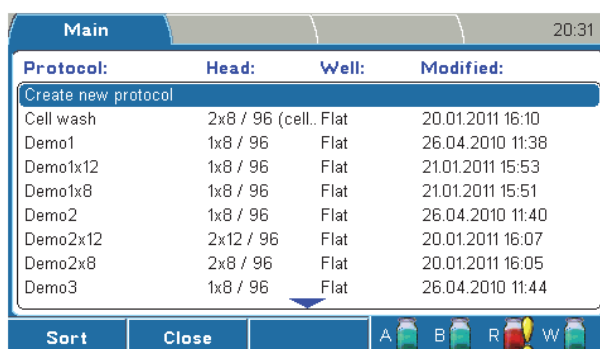

3. Press the **FILE** key to open the **File** menu.

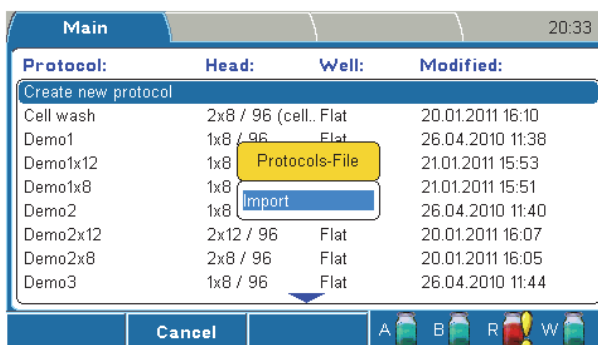

4. Select **Import** and press the **OK** button.
A list of protocols stored on the USB memory device opens.

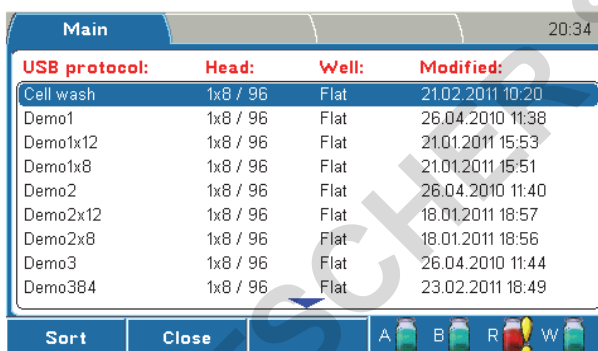

5. Select the protocol you want to import and press the **OK** button.
You can import protocols one at a time.

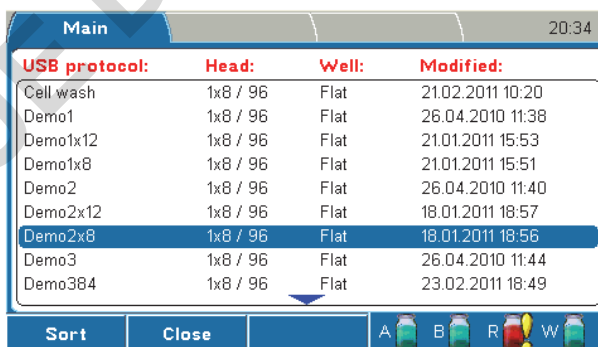

The protocol is imported to the instrument and it is available in the list of protocols. It is also possible to import protocols from the Wellwash instrument.

Exporting a protocol as text file

You can export a protocol as a text file to a USB memory device. The text file has information about the protocol, such as the name, the steps and their parameters, modification date, wash head, well type, and well offset.

1. Insert the USB memory device (Figure 7–41).



2. Select the **Protocol** row in the **Main** menu and press the **OK** button. The list of protocols appears.

Protocol:	Head:	Well:	Modified:
Create new protocol			
Cell wash	2x8 / 96 (cell..	Flat	20.01.2011 16:10
Demo1	1x8 / 96	Flat	26.04.2010 11:38
Demo1x12	1x8 / 96	Flat	21.01.2011 15:53
Demo1x8	1x8 / 96	Flat	21.01.2011 15:51
Demo2	1x8 / 96	Flat	26.04.2010 11:40
Demo2x12	2x12 / 96	Flat	20.01.2011 16:07
Demo2x8	2x8 / 96	Flat	20.01.2011 16:05
Demo3	1x8 / 96	Flat	26.04.2010 11:44



3. Select the protocol you want to export.



4. Press the **FILE** key to open the **File** menu.

Protocol:	Head:	Well:	Modified:
Create new protocol			
Cell wash	2x8		25.02.2011 09:41
Demo1	2x8		25.02.2011 10:12
Demo1x12	1x12		25.02.2011 09:44
Demo1x8	1x8		25.02.2011 09:45
Demo2	2x8		25.02.2011 10:06
Demo2x12	2x12		25.02.2011 10:06
Demo2x8	2x8		25.02.2011 10:08
Demo3	2x8		25.02.2011 10:09

Protocols-File

- Open
- Delete
- Quick Key >
- Export
- Import
- ASCII export



5. Select **ASCII export** and press the **OK** button.

The protocol is exported to the USB memory device. The ASCII exported file name is the same as that of the binary file with the *.TXT* extension. You can open the file with a text editor, print it or save it.

Chapter 8

Deleting

Deleting a protocol

To delete a protocol:



1. Select the **Protocol** row in the **Main** menu and press the **OK** button. The list of protocols appears.

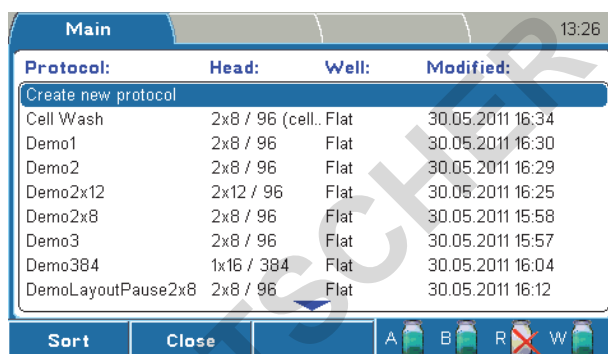

2. Select the protocol you want to delete.



3. Press the **FILE** key to open the **File** menu.

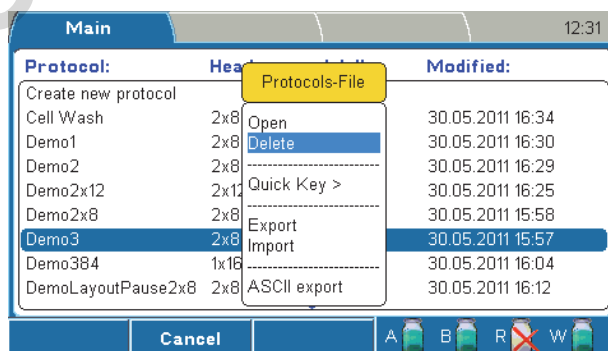

4. Select **Delete** and press the **OK** button.

Deleting

Deleting a protocol

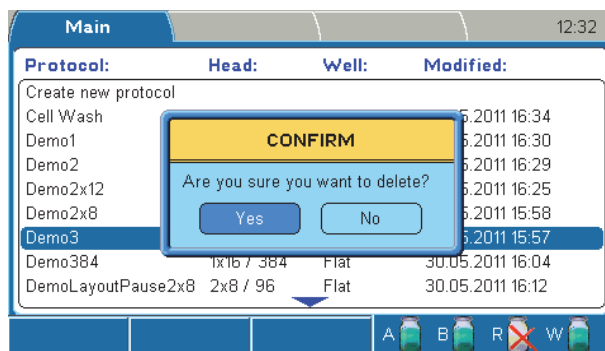

OK

5. Select **Yes** and press the **OK** button to confirm the deletion.

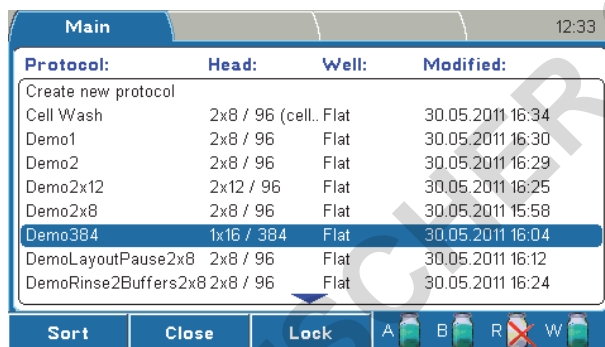

The wash protocol has now been deleted.

Chapter 9

Shutdown

Shutting down

It is recommended to shut down the Wellwash Versa at the end of the day.

1. Remove any plates still in the instrument.
2. Empty the wash bottle(s) and fill them with deionized distilled water. Then prime the instrument.
3. Rinse the liquid system with deionized distilled water to remove any buffer solution from the liquid tubing and wash head. The rinsing procedure should be performed if the instrument is left to stand or is switched off at the end of operation.

If the instrument will be left to stand for a short time during the same day, the wash head can be immersed in wash buffer or deionized distilled water. Refer to “Soak wash head” on page 92 and “Move wash head” on page 93.



Caution If the wash heads are not rinsed, the tips may become clogged. If this occurs, the wash heads will need to be cleaned, repaired or may have to be replaced. ▲

4. If the instrument will be left to stand for a longer time, priming must be performed to remove all liquid from the system. For this purpose, remove all tubes from the liquid bottles. Prime the instrument without liquid to empty all liquid from the system.
5. Switch off the instrument.
6. If you have spilled infectious agents on the instrument, disinfect with 70% ethanol or another disinfectant (see “Decontamination procedure” on page 122).
7. Finally empty the waste bottle.



Warning The wash heads and priming vessel may be infectious after the instrument has been used. ▲

Shutdown
Shutting down



Warning When handling the waste bottle, it is advisable to observe applicable safety precautions, such as the wearing of disposable powder-free gloves, safety glasses, and protective clothing, to avoid potential infectious disease contamination. ▲

DOMINIQUE DUTSCHER SAS

Chapter 10

Emergency Situations

Handling abnormal situations

If there is any abnormal situation during operation, such as fluids spilling inside the instrument:

1. Switch off the instrument (see Figure 3–26 on page 34).
2. Unplug the instrument immediately from the power supply (see Figure 3–25 on page 34).
3. Carry out appropriate corrective measures. Do not disassemble the instrument.
4. If the corrective measures taken do not help, contact authorized technical service or your local Thermo Fisher Scientific representative.

DOMINIQUE DUTSCHER SAS

Chapter 11

Maintenance

Regular and preventative maintenance

Contact local authorized technical service or your local Thermo Fisher Scientific representative for assistance, if needed.

Maintenance checklist

This chapter contains an outline of the points mentioned in the checklist below (Table 11–8).

Table 11–8. Maintenance checklist

Item	Daily	Weekly	Monthly	Yearly	If needed
Perform the operational check. See "Performing the operational check after switching on" on page 31.	✓				
Rinse the instrument with deionized distilled water after use. See "Instrument care" on page 114.	✓				
Keep the instrument free of dust. See "Instrument care" on page 114.	✓				
Wipe away spilled saline solutions, solvents, acids or alkaline solutions from outer surfaces immediately to prevent damage, and wipe with deionized distilled water. See "Cleaning the instrument" on page 115.	✓				
If any surfaces have been contaminated with biohazardous material, disinfect with a mild sterilizing solution. See "Instrument care" on page 114.	✓				
Clean the case of the instrument periodically. See "Cleaning the instrument" on page 115.		✓			
Clean the plate carrier if needed. See "Cleaning the plate carrier" on page 116.		✓			
Clean the priming vessel if needed. See "Cleaning the priming vessel" on page 115.					✓
Clean the liquid bottles regularly. See "Cleaning liquid bottles" on page 117.	✓	✓			
Check the performance of the liquid sensors. See "Checking the liquid level sensors" on page 118.	✓				
Clean or replace the liquid filter (Figure 11–44) of the intake tube if needed. See "Cleaning liquid bottles" on page 117.			✓		✓
Clean the wash head daily and replace if needed. See "Cleaning the wash head(s)" on page 119.	✓				✓
Check the dispensing accuracy and calibrate if needed. See "Checking the dispense accuracy" on page 121 and "Calibration" on page 95.			✓	✓	
Check the aspirate height. See "Checking the aspirate height" on page 121.			✓	✓	
Replace the tubing if needed. Contact service.					✓

Continued

Maintenance

Regular and preventative maintenance

Cont.

Item	Daily	Weekly	Monthly	Yearly	If needed
Ensure proper shutdown. See Chapter 9: "Shutdown".	✓	✓			
Decontaminate the instrument when relocating the instrument or sending it for service. See "Decontamination procedure" on page 122.					✓
Service the instrument regularly. See "Cleaning the instrument" on page 115 and "Maintaining a system log" on page 125.				✓	

✓ = depending on the laboratory conditions and the use and configuration of the instrument

Instrument care

Routine and service procedures must be performed by the user to prevent unnecessary wear or hazards and are described below at the frequency with which they should be applied.

Always ensure that the electrical supply in the laboratory conforms to that specified on the type label of the instrument.

To guarantee continuous reliability and accuracy of the Wellwash Versa:

- Prime all the channels of the instrument with deionized distilled water after use.
- Prevent any liquid from entering the instrument.
- Keep the instrument free of dust and other foreign matter.
- Perform operational checks regularly (see "Performing the operational check after switching on" on page 31).

In the event of any damage, contact your local Thermo Fisher Scientific representative for service.

Abrasive cleaning agents are not recommended, because they are likely to damage the paint finish.

It is recommended that you clean the case of the instrument periodically to maintain its appearance (see "Cleaning the instrument" on page 115).

Clean the keypad and display surface with a mild laboratory detergent.

Plastic covers and surfaces can be cleaned with a mild laboratory detergent, mild bleach or diluted alcohol solution.



Warning If any surfaces have been contaminated with biohazardous material, a mild sterilizing solution should be used. ▲



Caution Do not use the instrument to aspirate or dispense any strong acidic or alkaline solutions as this could damage the instrument. ▲



Caution Do not use acetone, as it will damage the covers. ▲



Caution Do not autoclave any part of this instrument apart from those specified in Table 11–9 and Figure 11–44. ▲

Cleaning the instrument

Clean the instrument regularly as stated below.



Caution Although the Wellwash Versa is constructed from high-quality materials, you must immediately wipe away spilled saline solutions, solvents, acids, or alkaline solutions from the outer surfaces to prevent damage and wipe them with deionized distilled water. ▲



Caution Painted surfaces can be cleaned with most laboratory detergents. Dilute the cleaning agent as recommended by the manufacturer. Do not expose painted surfaces to concentrated acids or alcohols for prolonged periods as damage may occur. ▲

1. Switch the power off and unplug the instrument.
2. Use disposable powder-free gloves.
3. Clean the instrument exterior and the plate carrier with a soft cloth dampened with water or mild detergent.
4. If you have spilled infectious agents on the instrument, decontaminate the instrument. Refer to “Decontamination procedure” on page 122.



Caution Do not use solutions containing hypochlorite, such as bleach, on the stainless steel surfaces, as this may cause permanent damage to the finish. ▲

Salt deposit

Depending on the concentration of the wash buffers, crystallization may occur around the dispense tips and bottle necks. Therefore, regular cleaning of these parts is essential. Refer to “Cleaning liquid bottles” on page 117 and “Clean wash head” on page 90.

Cleaning the priming vessel

The instrument comes with the priming vessel installed. The priming vessel is correctly installed if it stays in place and does not move up. The priming vessel is removed for maintenance purposes only.

Maintenance

Cleaning the plate carrier

To remove the priming vessel:

1. Push the priming vessel away from yourself towards the instrument until you hear a snap.
2. Lift the priming vessel up and remove it (Figure 11–42).

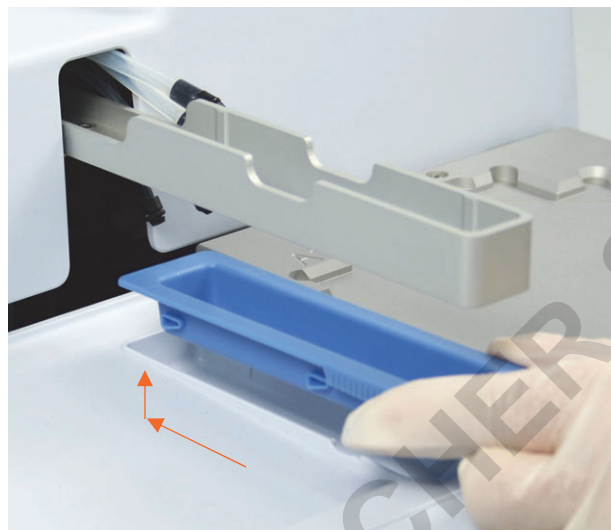

Figure 11–42. Removing the priming vessel

3. Clean the priming vessel with a mild detergent and rinse with deionized distilled water.
4. Replace the priming vessel by inserting it downwards and pulling it towards yourself.



Warning The priming vessel may be contaminated after the instrument has been used. ▲

Cleaning the plate carrier



To clean the plate carrier:

Caution Do not disassemble the plate carrier. ▲

1. Switch the power off and unplug the instrument.
2. Use disposable powder-free gloves.
3. If spillages have occurred, move the plate carrier by pushing it to the left (Figure 11–43). This makes it easier for you to clean the area under the plate carrier.

4. Wipe both the plate carrier and the area surrounding it with a mild detergent.
5. Clean the plate carrier immediately when spillages have occurred on or around the plate carrier. Be especially careful with the area close to the plate clamp!



Figure 11–43. Cleaning the plate carrier and the surrounding area

6. Move the plate carrier back to its normal position once it has been cleaned.

Cleaning liquid bottles

Empty the waste bottle before cleaning it according to disposal regulations (see “Disposal of materials” on page 122).

The bottles must be cleaned regularly depending on the applications, using a mild detergent.

The liquid bottles, tubes, and tube connectors can be autoclaved some five to ten times (Figure 11–44). The liquid level sensors or the liquid filters cannot be autoclaved (Figure 11–44).



Caution Clean or replace the liquid filter of the intake tube regularly. For example, back flush the liquid filter with detergent or use an ultrasonicator. ▲

Maintenance

Checking the liquid level sensors

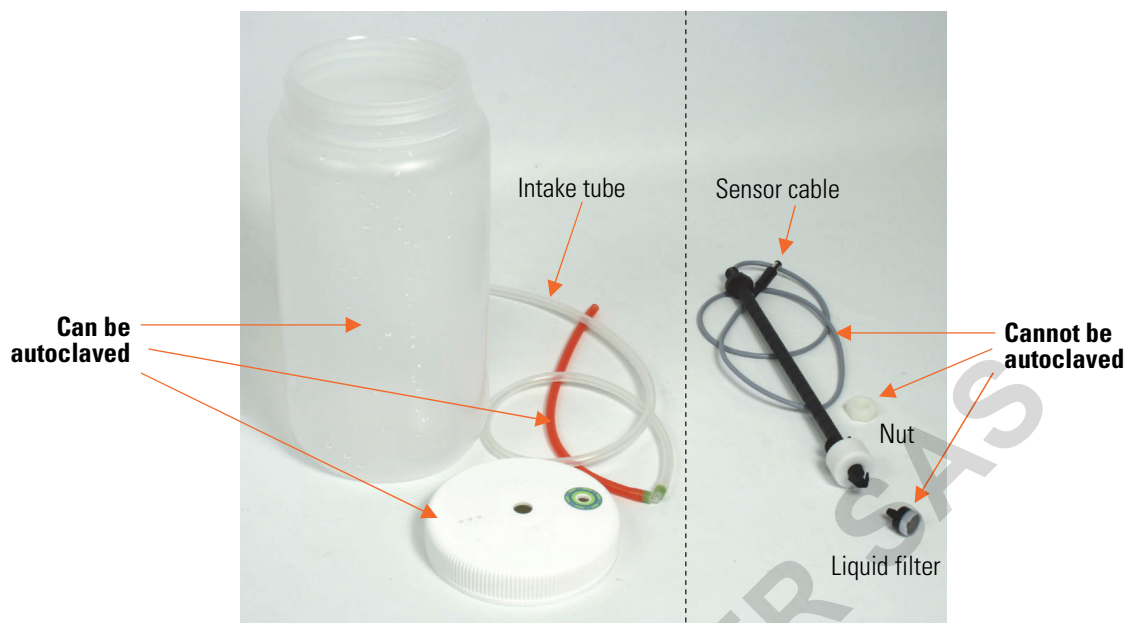

Figure 11–44. Autoclavable and un-autoclavable liquid bottle parts



Warning When handling the waste bottle, it is advisable to observe applicable safety precautions, such as the wearing of disposable powder-free gloves, safety glasses, and protective clothing, to avoid potential infectious disease contamination. ▲

Checking the liquid level sensors

Check the performance of the liquid level sensors, as described in the “Liquid bottles and channels” on page 22 and “Performing the operational check after switching on” on page 31.

Autoclavation

You may autoclave, that is, sterilize materials with pressurized steam. *Autoclavable* and *un-autoclavable* parts of the washer unit are listed in Table 11–9. Refer also to Figure 11–44.

The autoclaving conditions are as follows: at 121°C with 1 bar underpressure for 20 minutes.

Table 11–9. Autoclavable and un-autoclavable parts of the washer

Autoclavable	Un-autoclavable
2x8 cell wash head	Aerosol cover
Liquid bottles	Blank wash head
Liquid bottle caps	Liquid filter
Intake tubes	Liquid level sensor assemblies
Priming vessel	Sensor nut
Tube connectors	1x8 wash heads
	1x12 wash heads
	1x16 wash head

Cleaning the wash head(s)

To clean the wash head(s), refer to features in the **Maintenance** menu: “Clean wash head” on page 90, “Soak wash head” on page 92, and/or “Move wash head” on page 93.

Wash head tips that are clogged can be cleaned using a declogging tool (Figure 11–45). The *thin declogging tool* is intended for declogging a 2x8 cell wash head and/or a 1x16 wash head and the *normal declogging tool* for declogging other wash heads than the above-mentioned.



Warning The wash heads may be contaminated after the instrument has been used. ▲



Warning Disinfect the wash heads thoroughly before you remove them. ▲



Warning Prime the instrument without liquid (with air) to empty all liquid from the system before removing the wash heads. ▲



Warning When handling the waste bottle, it is advisable to observe applicable safety precautions, such as the wearing of disposable powder-free gloves, safety glasses, and protective clothing, to avoid potential infectious disease contamination. ▲



Caution Clean the wash head tips regularly. Wash head tips that are clogged can be cleaned using a declogging tool (Figure 11–45). ▲



Figure 11–45. Thin and normal declogging tools

Check that the wash head tips are in good condition and not deformed.

Mechanical cleaning of the wash head

- Detach the wash head from the tubing.
- Remove the wash head plugs and use the declogging tool to clean the tips.

Maintenance

Changing or replacing the wash head

- Rinse both channels with deionized distilled water using the syringe supplied with the instrument.
- Refit the wash head plugs.
- Attach the wash head to the instrument, prime the system and ensure that liquid comes out evenly from all tips.



Caution Avoid breaking the smaller aspiration tube while detaching the wash head. If the tube breaks, replace with a new one. Do not use any other type of tubing. ▲

Changing or replacing the wash head

If you change the wash head to another type, first change the wash head type in the **Settings** menu and then calibrate the wash head.

If you replace the wash head to the same type, calibrate the new wash head.

Refer to “Installing the wash head(s)” on page 18 and “Calibrate current wash head” on page 97.



Checking the liquid line

Caution Only use wash heads that have an identification label. ▲

Check the liquid line for possible leaks. Ensure that the silicone tubes are intact and there are no breaks or holes in them.

To ensure valve operation, first prime the system, then lift the buffer bottle about 20 cm and finally ensure that the tips are not dripping.

Checking the residual volume

Check the residual volume by dispensing 200 µl of 0.02% Tween™ solution over the whole plate. Aspirate and determine the residual volume by weighing the plate.

Make a protocol with a Dispense and an Aspirate step:

1. Dispense: 200 µl, Dispense height end: 17.
2. Aspirate: Aspirate mode: Sweep2, Aspirate height: 2.6mm, Aspirate speed: High, Aspirate time: 1s.

Tare weigh an empty plate using a laboratory balance. Select the whole plate and run the protocol. Weigh the plate again and determine the average residual volume per well in µl by dividing the mass in mg by 96.

Example: Residual liquid weight 91.2 mg. Residual volume/well [µl] = $91.2/96$ [µl] = 0.95 [µl]

Checking the dispense accuracy

Check the dispensing accuracy by dispensing one volume over the whole plate and determine the volume by weighing the plate.

Create a dispense protocol which dispenses 300 µl over the whole plate. Tare weigh an empty plate using a laboratory balance and dispense 0.02% Tween solution onto the plate. Weigh the plate again and determine the average volume dispensed per well in µl by dividing the mass in mg by 96.

Example: Dispensed liquid weight 28.608 g. Volume/well [µl] = 28608/96 [µl] = 298 [µl]

Checking the aspirate height

Check the aspirate height by aspirating at the 0.0 mm level.

Make a protocol with an Aspirate step: Aspirate mode: Normal, Aspirate height: 0.0, Aspirate time: 10.

Disable the Plate sensor. Select the first column/strip and press **Start** without a plate. The wash head moves to the 0.0 mm level. Ensure that the wash head tips are on the plate bottom level of the plate carrier. Refer to Figure 6–40. Enable the Plate sensor after the test.

Manual priming

If both the Prime and Boost prime functions fail, you have to perform manual priming.

To prime a dry pump manually (Figure 11–46):

1. Fill the buffer bottle completely with liquid and close the cap. Place the bottle at the same level as the instrument.
2. Disconnect the liquid bottle tube from the tube fitting on the instrument.
3. Attach a 20 ml plastic syringe (Cat. No. N02942, supplied with the instrument) to the free end of the tube.
4. Gently aspirate liquid from the liquid bottle to fill the tube by “filling” the syringe. Leave a few centimeters of air at the end of the tube to prevent spilling.
5. Close (pinch) the tube, continue pinching the tube and then disconnect the tube from the syringe.
6. Reattach the tube to the fitting on the instrument side and release your grip.



7. Press the **PRIME** button on the instrument keypad and prime the channel.

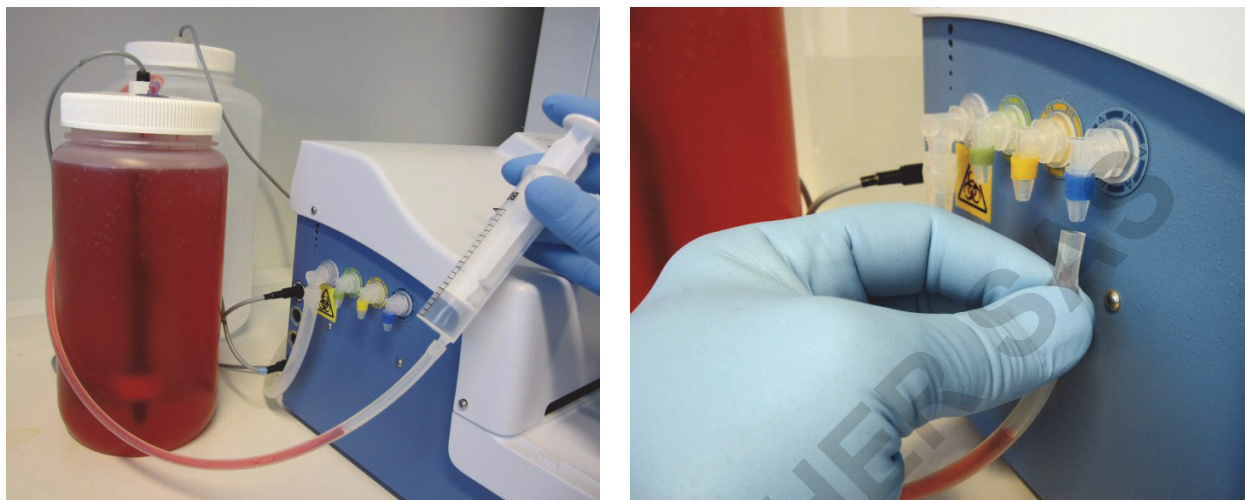

Figure 11-46. Manually priming a dry pump. Colored liquids are used for illustrative purposes.



Warning Do not use boost priming if manual priming works, as doing so may cause liquid spillage. ▲

Disposal of materials

Follow laboratory and country-specific procedures for biohazardous or radioactive waste disposal. Refer to local regulations for the disposal of infectious material.



Warning The samples can be potentially infectious. Dispose of all used plates, disposable gloves, syringes, disposable tips, and so on as biohazardous waste. Be cautious and always use disposable gloves. ▲



Warning Treat the used microplate, waste bottle, priming vessel on the plate carrier, disposables, and all substances used in accordance with good laboratory practice (GLP) guidelines. ▲



Warning Inquire about appropriate collection points and approved methods of disposal in your country, state, or region. ▲

Decontamination procedure

If you have spilled infectious agents, carry out the decontamination procedure.



Warning The decontamination procedure should be performed by authorized trained personnel in a well-ventilated room wearing disposable gloves, protective glasses, and clothing. ▲

Decontamination should be performed in accordance with normal laboratory procedures. Any decontamination instructions provided with the reagents used should be followed.

It is strongly recommended to perform the complete decontamination procedure before relocating the instrument from one laboratory to another.

Example of decontaminants:

- Ethanol 70%
- Virkon™ solution 1–3%
- Glutaraldehyde solution 4%
- Chloramine T
- Microcide SQ™ 1:64
- Decon™ 90 min. 4%



Caution If local or laboratory regulations prescribe regular decontamination, it is not advisable to use formaldehyde, since even small traces of formaldehyde negatively affect the enzyme being used in EIA tests, resulting in inconsistent test results. ▲

1. Prepare the decontaminant.
2. Run the Maintenance > **Cleaning/Disinfection procedure** using the prepared decontaminant. Refer to “Cleaning/Disinfection procedure” on page 87.
3. Autoclave the liquid bottles, tubes and liquid connectors if needed (Figure 11–44). However, the liquid level sensors or the liquid filters cannot be autoclaved (Figure 11–44).
4. Empty the plate carrier. You must wear disposable powder-free gloves.
5. Switch off the power and disconnect the power supply cable.
6. Disinfect the outside of the instrument using a cloth dampened with 70% ethanol.

Maintenance

Refitting the transport lock

7. Place the instrument in a large plastic bag.
8. Place a cloth soaked in the prepared decontaminant solution into the bag. Ensure that the cloth does not come into contact with the instrument.
9. Seal the bag firmly and leave the instrument in the bag for at least 24 hours.
10. Remove the instrument from the bag.
11. After decontamination, clean the instrument using a mild detergent.
12. After performing this decontamination procedure, enclose a signed and dated “*Certificate of Decontamination*” (see Appendix B) both inside the transport package and attached to the outside of the package.

Refitting the transport lock

When you relocate the instrument or ship it for service, make sure that you refit the transport lock.

1. Switch off the instrument.
2. Align the wash head arm and the plate carrier in order to refit the transport lock screw (Figure 11–47).



Figure 11–47. Aligning the plate carrier and wash head arm

3. Screw on the transport lock screw and the transport lock tag with the supplied Allen key (Figure 11–48).

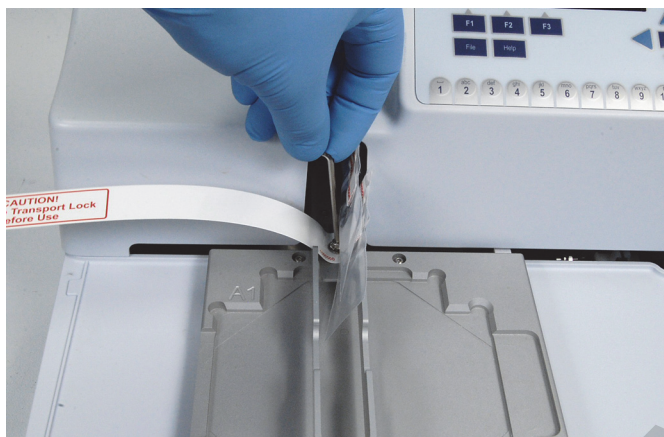

Figure 11–48. Fastening the transport lock

4. Place small plastic bags around the tubes to protect them during transport.
5. Insert the padded packing material around the plate carrier and wash head arm for protection after the transport lock is refitted (Figure 11–49).



Figure 11–49. Transport lock and tag fitted

Maintaining a system log

A system log, which includes a short summary of the use, maintenance procedures, error messages and other information about the use of the system, aids proper maintenance of the system. Refer to Appendix A: “System Log”.

How to pack for service

To pack the Wellwash Versa for service:

- Provide information about the use of hazardous materials.
- Prime all the channels of the instrument and clean the wash and waste bottles.
- Remove any microplate before decontamination. Decontaminate the instrument. Remove the liquid bottles and wash heads.

- Refit the transport lock. Refer to “Refitting the transport lock” on page 124.
- Use the original packaging for shipping.
- Pack the instrument according to the packing instructions.
- Enclose a dated and signed “*Certificate of Decontamination*” (see Appendix B) both inside and attached to the outside of the package, in which you return your instrument (or other items).
- Enclose the return authorization number (RGA) issued by your local Thermo Fisher Scientific representative.
- Specify the fault after you have been in touch with your local Thermo Fisher Scientific representative or the Thermo Fisher Scientific technical service department.

Disposal of the instrument

If the Wellwash Versa is exposed to potentially infectious chemical samples, toxic or corrosive chemicals, or radioactive chemicals, waste management of the complete instrument must be carried out to ensure that there is no risk of contamination.



Warning Decontaminate the instrument before disposal. Refer to “Decontamination procedure” on page 122. ▲



Caution Observe all federal, state and local environmental regulations. ▲

Follow laboratory and country-specific procedures for biohazardous or radioactive waste disposal.



Warning The used lithium (Li) battery is regulated waste and must be disposed of according to local regulations. The Li battery has to be changed by an authorized service technician only. Instructions for changing the Li battery are described in the service manual. ▲



Warning Dispose of the instrument according to the legislation stipulated by the local authorities concerning take-back of electronic equipment and waste. The proposals for the procedures vary by country.

Pollution degree 2 (see “Safety specifications” on page 131)

Method of disposal Electronic waste
Contaminated waste
(Infectious waste) ▲



WEEE symbol Do not treat electrical and electronic equipment as unsorted waste. Collect waste from electrical and electronic equipment separately. ▲

Regarding the original packaging and packing materials, use the recycling operators known to you.

For more information, contact your local Thermo Fisher Scientific representative.

DOMINIQUE DUTSCHER SAS

Maintenance

Disposal of the instrument

DOMINIQUE DUTSCHER SAS

Chapter 12

Technical Specifications

General specifications

Thermo Fisher Scientific reserves the right to change any specifications without prior notice as part of our continuous product development program (Table 12–10 and Table 12–11).

Table 12–10. General specifications

General specifications	
Overall dimensions	ca. 345 mm (W) x 385 mm (D) x 240 mm (H) [13.6" (W) x 15.2" (D) x 9.4" (H)]
Weight	9 kg [19.8 lbs.]
Operating conditions	+10°C to +40°C; maximum relative humidity 80% for temperatures up to 31°C decreasing linearly to 50% relative humidity at 40°C Indoor use only!
Transportation conditions	-40°C to +70°C, packed in transport packaging
Storage conditions	-25°C to +50°C, packed in transport packaging
Mains power supply	100–240 Vac, 50/60 Hz, nominal
Power consumption	100 VA max.
Heat dissipation	341 BTU max.
Noise	< 75 db (at a distance of 500 mm)
Display	High-contrast color display with 480 x 272 dots
Keypad	Four arrow keys; OK button; three function keys F1-F3 ; FILE and HELP keys; 0-12 number keys; a-z letters, + - and space with the number keys; c key; START , STOP , PRIME , and RINSE buttons
User interface	Graphical user interface
Computer interface	USB 1.1 (2.0 compatible), RS 232
Plate types	96- and 384-well plates Maximum height 16.0 mm
Number of buffers	2 buffers and 1 rinse buffer

Performance specifications

This section provides the performance specifications at 18°C to 30°C and relative humidity 30% to 80% for the 1x8 and 1x12 wash heads.

Table 12–11. Performance specifications

Performance specifications	
Wash volume	50–1000 µl in 50 µl increments (96-well plate) 20–120 µl in 10 µl increments (384-well plate)
Wash cycles	1–10
Residual volume	< 2.0 µl per well with sweep aspirate mode and with high aspirate speed at room temperature (flat-bottom 96-well plate)
Aspirate height	Adjustable, 0–14 mm in 0.1 mm increments
Dispense volume	50–400 µl in 50 µl increments (96-well plate) 20–120 µl in 10 µl increments (384-well plate)
Dispense accuracy	< 5% @ 300 µl at room temperature, with nx8 or nx12 wash head < 5% @ 250 µl, with 2x8 cell wash head < 5% @ 100 µl, with 1x16 wash head
Dispense precision	< 3% (CV) @ 300 µl, with nx8, nx12, and 1x16 wash heads
Soak time	1 s – 60 min in increments of 1 s/min
Rinse volume	5–100 ml in 5 ml increments
Prime volume	5–100 ml in 5 ml increments
Memory	At least 100 protocols
Linear shaker	Amplitude 2.5 mm; 5 Hz Amplitude 1.5 mm; 10 Hz Amplitude 1 mm; 15 Hz

Safety specifications In conformity with the requirements

This section describes the safety specifications for the Wellwash Versa instrument.

Wellwash Versa bears the following markings:

Type 888
100–240 Vac, 50/60 Hz, 100 VA max., Class I
CE marking
cTÜVus

The safety specifications are also met under the following environmental conditions in addition to or in excess of those stated in the operating conditions:

Altitude	Up to 2000 m
Temperature	+5°C to +40°C
Humidity	Maximum relative humidity 80% for temperatures up to 31°C decreasing linearly to 50% relative humidity at 40°C
Mains supply fluctuations	± 10% from nominal
Installation category (overvoltage category)	II according to IEC 60664-1 (see Note 1)
Pollution degree	2 according to IEC 60664-1 (see Note 2)



Note 1) The *installation category* (overvoltage category) defines the level of transient overvoltage which the instrument is designed to withstand safely. It depends on the nature of the electricity supply and its overvoltage protection means. For example, in CAT II which is the category used for instruments in installations supplied from a supply comparable to public mains, such as hospital and research laboratories and most industrial laboratories, the expected transient overvoltage is 2500 V for a 230 V supply and 1500 V for a 120 V supply.

2) The *pollution degree* describes the amount of conductive pollution present in the operating environment. Pollution degree 2 assumes that normally only nonconductive pollution, such as dust, occurs with the exception of occasional conductivity caused by condensation. ▲

Technical Specifications

Safety specifications

DOMINIQUE DUTSCHER SAS

Chapter 13

Troubleshooting Guide



Error and warning codes

Note Do not use the instrument if it appears to be malfunctioning. ▲

When an error is detected, the current operation is terminated. After an error, it is best to abort the current run and restart from the beginning after the problem is fixed. To abort, press the **STOP** button after an error and accept by pressing the **OK** button.

The error (Table 13–12) and warning codes (Table 13–13) are presented below.

Table 13–12. Error codes reported

Code	Explanation	Suggested action
2	Computer command not recognized.	Check the syntax.
3	Invalid computer command argument.	Check the syntax.
4	Plate position error.	Check the carrier movement. Contact authorized technical service.
5	Head position error.	Check the head movement. Contact authorized technical service.
6	Dispense pump rotation error.	The pump is jammed. Contact authorized technical service.
7	Dispense pump time out.	The pump is jammed. Contact authorized technical service.
8	Plate was not detected.	Insert the plate properly.
9	Plate sensor doesn't work.	Contact authorized technical service.
10	Non-volatile parameters lost.	Contact authorized technical service.
11	Attempt to reset the serial number.	–
12	No more memory for storing user data.	Memory is full; delete unused protocols.
13	Error(s) during startup.	Contact authorized technical service.
20	USBwiz error.	Contact authorized technical service.
21	No firmware on the USBwiz chip.	Contact authorized technical service.
22	XY offset adjustment failed.	–
23	More than one command has the same hash value.	–
25	Parameter memory not found.	Contact authorized technical service.
26	Parameter memory erase failure.	Contact authorized technical service.

Continued

Code	Explanation	Suggested action
27	Parameter memory write failure.	Contact authorized technical service.
50	File open error. File not found.	–
53	The file already exists.	Use a different file name.
54	The file does not exist.	–
55	The media is full.	Delete unused protocols.
56	End of file.	–
57	Other file error (none of the previous).	–
58	Firmware update aborted by user.	–
59	File read failed.	–
60	File not found.	–
61	USB memory stick not present.	Insert a USB memory device.
62	File write failed.	–
70	Not enough memory.	Delete unused protocols.
71	Adding the step not successful.	–
80	Invalid step parameter(s).	–
81	Too many step parameters.	–
82	At least one of the step parameters is missing.	–
83	Step list is not empty.	–
84	Creating a new step list failed.	–
85	No strips are selected.	Select strips.
86	Invalid SOF parameter.	–
91	USB device timeout.	Try with another USB memory device.

Table 13–13. Warning codes reported

Code	Explanation	Suggested action
101	WAI timer already timed out.	–
102	Liquid level alert.	Check the liquid levels in the bottles.

USB memory device

It is recommended to format the USB memory device if export or import fails.

It is recommended to use FAT16 or FAT32 formatted USB memory devices.

It is not recommended to use multiple drive USB memory devices that contain virtual CD drives.

The multiple drive USB memory devices normally contain one or more removable disk-type memory spaces, but can also contain virtual CD drive-type memory spaces. The Wellwash Versa does not support virtual CD drive-type memory spaces.

It is possible to check if there is a virtual CD drive present when inserting a multiple drive USB memory device into the PC USB port.

1. Select **My Computer** and note the new drives that appear in the list when the multiple drive USB memory device is inserted.
2. Check all the appearing items by using the right-click mouse menu and selecting **Properties**.
3. The item type "Removable Disk" is stated for the USB memory device in the **General** sheet. It is compatible with the Wellwash Versa if the File system is FAT16 or FAT32.
4. If the item is a virtual CD drive, then the type will be "CD Drive". This may cause the USB memory device to be incompatible with the Wellwash Versa.

Troubleshooting guide

The problems covered below are considered faults that require repair or corrective work (Table 13–14). If problems occur or reoccur, contact authorized technical service immediately.

Table 13–14. Troubleshooting guide

Symptom	Description	Suggested action
Dispensing volume is too low or residual volume is too high.	Tubing is old or clogged.	Use Maintenance > Clean > Soak wash head .
	Wash head tips are blocked.	Clean or replace the tubing.
	Too high an aspiration position.	Clean the wash head tips with the declogging tool. Replace the wash head. Define the correct aspirate height.
Dispensing volume is too low.	Filter is blocked.	Calibrate the wash head.
	The selector valve is not functioning properly.	Clean the liquid filters in the bottles. Component failure. Contact authorized technical service.
Volume is too low.	Tips are deformed.	Change the wash head.
	Leakage in tubing.	Clean or replace the tubing.
Wrong volume is dispensed.	Dispensing valve is leaking when closed.	Component failure. Contact authorized technical service.
	Wash head is incorrectly aligned.	Check that the wash head is properly fitted.
	Improper liquid calibration.	Calibrate the wash head.
	Underpressure in the bottle.	Do not cover the venting holes in the liquid bottle caps.
	Too low maximum well volume has been defined.	Check the step parameter and adjust it.
	Pump characteristics have changed.	Calibrate the dispensing pump speed. Component failure or wear. Contact authorized technical service.

Continued

Symptom	Description	Suggested action
	Ambient temperature is too high or too low.	Check the ambient temperature.
Wrong volume is aspirated.	Overpressure in the bottle. Pump characteristics have changed. Wrong parameters are used.	Do not cover the venting holes in the bottle caps. Contact authorized technical service. Check the parameters.
Plate is processed incorrectly. Reagents are mixed.	A non-active valve is leaking.	Component failure. Contact authorized technical service.
Keys of the keypad do not function.	Keypad is broken.	Contact authorized technical service.
Display does not show all the information or anything at all.	Display is broken.	Contact authorized technical service.
Liquid is dispensed onto the plate carrier.	The plate orientation is incorrect. The installed wash head is incorrect.	Check the layout and place the plate in the correct orientation required by the wash head configuration. Check the wash head and replace the correct wash head required by the layout and the protocol.
Liquid is spilled during operation.	Well volume or shake speed is too high.	Check the tubing and O-rings, and replace if needed. Decrease the well volume or shake speed.
Priming failed.	Tubing incorrectly installed. Tubing and/or liquid filters are clogged. Priming volume too low. Not enough buffer liquid. Instrument has not been used for a long time. Liquid system completely dry or abnormal placement of liquid bottles.	Check the tubing. Clean or replace the tubing. Increase the priming volume. Fill the corresponding buffer bottle completely. Use the Maintenance > Service > Boost prime option. Move the liquid bottles to the instrument level. Perform a manual priming, see "Manual priming" on page 121.
Tips are dripping.	Air leak. Valve is leaking.	Check that the tubes and wash head plugs are properly fitted. Check that the tubing is intact. Apply silicone to the O-ring. Contact authorized technical service.

Chapter 14

Ordering Information

Contact your local Thermo Fisher Scientific representative for ordering and service information (Table 14–15 and Table 14–16).

Wellwash Versa

Table 14–15. Instrument catalog number

Code	Item
5165010	Wellwash Versa 2x8
5165050	Wellwash Versa 2x12

List of spare parts and accessories

Table 14–16. Codes for spare parts and accessories

Code	Item	Quantity
N11166	<i>Wellwash Versa User Manual, CD</i>	1
N11165	<i>Wellwash and Wellwash Versa Quick Reference Guide</i>	1
N09541	Priming vessel SW smooth blue	1
N10800	1x8 wash head	1
N10801	1x12 wash head	1
N10803	1x16 wash head, Wellwash Versa	1
N10802	2x8 cell wash head, Wellwash Versa	1
N10804	Blank wash head, Wellwash Versa	1
N10807	2 liter wash bottle A, Wellwash Versa	1
N10808	2 liter wash bottle B, Wellwash Versa	1
N10809	2 liter rinse bottle, Wellwash Versa	1
N10810	4 liter waste bottle square	1
N10811	4 liter wash bottle A, round	1
N10812	4 liter wash bottle B, round, Wellwash Versa	1
N10813	4 liter rinse bottle, round, Wellwash Versa	1
N10814	9 liter waste bottle, rectangular, Wellwash Versa	1
N10816	Aerosol cover, Wellwash Versa	1
N10818	Bottle stand 2x2 configuration (3x2 l bottles, 1x4 l bottle (square)), Wellwash Versa	1
N10819	Bottle stand 1x4 configuration (3x2 l bottles, 1x4 l bottle (square)), Wellwash Versa	1

Continued

Code	Item	Quantity
N10820	Bottle stand for own bottle	1
N10821	Spare bottle 2 l	1
N10822	Spare bottle 4 l (round)	1
N12785	Spare cap for storage bottle, 2 pcs	1
N04001	USB A-B device cable 1.8 m *	1
N11116	Accessories Kit Incl. declogging tools normal/thin, syringe 20 ml, and silicon grease for O-rings	1
N12409	Wash head tubing connector Kit, 2 pcs each Incl. dispensing and aspiration tubing connectors (see Figure 14–50 B)	1
N12408	Cell wash head adapter, 2 pcs (see Figure 14–50 A)	1
N12407	Liquid filter, 5 pcs	1
2305290	Serial cable F9/F25	1
SP-00250	PM Kit Wellwash Versa	1

* Longer USB cables available from PC stores



Figure 14–50. Cell wash head adapters (A) and wash head tubing connectors (B)

DOMINIQUE DUTSCHER SAS

Appendix B

Certificate of Decontamination

Name: _____

Address: _____

Tel./Fax: _____

Instrument: _____ Serial No.: _____

A) I confirm that the returned items have not been contaminated by body fluids, toxic, carcinogenic or radioactive materials or any other hazardous materials.

B) I confirm that the returned items have been decontaminated and can be handled without exposing the personnel to health hazards.

Materials used in the unit: Chemicals + Biological • Radioactive *)

Specific information on contaminants: _____

Decontamination procedure¹: _____

Date and place: _____

Signature: _____

Name (block capitals): _____

*) The signature of a Radiation Safety Officer is also required when the unit has been used with radioactive materials.

This unit is certified by the undersigned to be free of radioactive contamination.

Date and place: _____

Signature: _____

Name (block capitals): _____

¹ Please include decontaminating solution used.

DOMINIQUE DUTSCHER SAS

Glossary

decontamination Removal or neutralization of radiologic, bacteriological, chemical, or other contamination.

disinfection The destruction of pathogenic bacteria, usually with an antiseptic chemical or disinfectant.

EIA Enzyme immunoassay. An immunoassay using a color-changing enzyme-substrate system for indicating results. A diagnostic test method to measure or detect a substance using antibody-antigen reactions.

ELISA Abbreviation for enzyme-linked immunosorbent assay.

remote control Running mode allowing a remote computer to operate the washer.

wash head Interchangeable twin-strip 2x8-way, 2x12-way, or 1x blanking heads allowing either 1x8, 2x8, 1x12, or 2x12 processing. A single 1x16-way wash head allows processing of a 384-well plate. A specific 2x8 (cell wash) wash head is used for washing cells.

USB Universal serial bus.

Index

Use the **Find** option for searching words/information in this user manual.

DOMINIQUE DUTSCHER SAS

Thermo Fisher Scientific Oy
Ratastie 2, P.O. Box 100
FI-01621 Vantaa
Finland

www.thermoscientific.com

DOMINIQUE DUTSCHER SAS