

E4 XLS+ Electronic Pipettes

Advanced Electronic Pipettes with RFID





E4™ XLS™ + Electronic Pipettes

- **Single channel models with LTS or with universal-fit shafts**
- **Multichannel models with LTS**
- **Adjustable spacer multichannel models with LTS**
- **All models RFID enabled**

Contents of Box

- E4 XLS+ Electronic Pipette
- Micro-SD card installed in pipette
- Battery
- Quick Reference Guide
- Sample Tips
- Wall Power Supply
- Conformance Certificate and Warranty Card

If any item is missing please call 800-472-4646 in the US, or contact your local METTLER TOLEDO office or distributor.

Safety Notice:

If this product is used other than as described in this manual, its safety protection may be impaired.

Rainin, Pipetting 360°, E4, XLS, XLS+, LTS, LiteTouch, Hang-Ups are trademarks of Mettler-Toledo Rainin, LLC. LabX and Pipette-Scan are trademarks of Mettler-Toledo International.

No part of this manual may be copied without the express written permission of Mettler-Toledo Rainin, LLC.

Contents

| | | |
|----------|---|-------------------|
| 1 | E4 XLS+ Single Channel Pipettes | |
| 1.1 | Introduction | 4 |
| 1.2 | Pipette Overview | 4 |
| 1.3 | Getting Started | 6 |
| 1.4 | Menus and Modes | 11 |
| 1.5 | Options and Settings | 12 |
| 1.6 | Using the Pipette | 15 |
| 1.6.1 | Pipetting Guidelines | 15 |
| 1.6.2 | Tip Selection and Mounting | 15 |
| 1.6.3 | Tip Immersion Depth | 16 |
| 1.6.4 | Sleep Mode and Power Shutdown | 16 |
| 1.6.5 | Help | 17 |
| 1.6.6 | Filter | 17 |
| 1.7 | Volume Ranges and Increments | 18 |
| 1.8 | Sound Alerts | 18 |
| 1.9 | Setup Mode | 19 |
| 1.10 | Admin Mode | 24 |
| 1.11 | Operational Modes | 28 |
| 1.12 | Level II Menu | 38 |
| 1.13 | Mode Presets | 46 |
| 1.14 | Service Mode | 49 |
| 1.15 | Battery Charging | 51 |
| 1.16 | Replacing the Battery | 52 |
| 1.17 | Storage | 53 |
| 1.18 | Tip Ejector Arm Removal | 53 |
| 1.19 | Care and Maintenance | 54 |
| 1.20 | Autoclaving | 55 |
| 1.21 | Upgrading your Liquid End to XLS+ | 55 |
| 1.22 | Troubleshooting | 56 |
| 1.23 | Micro-SD Card Management and Firmware Upgrades | 57 |
| 1.24 | Service, Calibration and Repair | 58 |
| 1.25 | Replacement Parts | 58 |
| 2 | RFID (Radio Frequency Identification Device) | |
| 2.1 | Description and Operation | 60 |
| 3 | E4 XLS+ Multichannel Pipettes | |
| 3.1 | Description and Operation | 63 |
| 4 | E4 XLS+ Multichannel Pipette with Adjustable Spacing | |
| 4.1 | Description and Operation | 66 |
| 5 | Appendices | |
| 5.1 | Speed Table | 68 |
| 5.2 | Glossary of Terms | 68 |
| 5.3 | Memory, Power and Settings Management | 71 |
| | Specifications | 72 |
| | EC Declaration of Conformity | Inside back cover |

1 E4 XLS+ Single Channel Pipettes

1.1 Introduction

Rainin's E4 XLS+ is a revolutionary electronic pipette fully laden with features and with a new graphical user interface that is extremely straightforward and intuitive in operation. The joystick control provides an easy to understand logic for setting operating modes and for aspiration and dispensing a variety of liquids. The pipette is designed for maximum comfort.

You can store your favorite protocols, configure the pipette set-up to your needs, and control access to pipette settings via passcode protection.

In models with the patented LTS™ LiteTouch™ Tip Ejection System, tip ejection forces are reduced by up to 85% in the single channel LTS models, and consistent sample pickup is easily attained across all channels in multichannel models, as well as tip ejection force reduction.

E4 XLS is available in single, multichannel and adjustable spacer versions.

All user settings and service settings are stored on non-volatile memory and are protected even if the pipette is reset or in the unlikely case of a battery failure.

E4's built-in Service GLP section help you track the pipette's service records and intervals. E4 XLS models also contain an RFID tag (radio-frequency identification) for facilitating calibration management for all your pipette assets.

This manual describes features introduced with the XLS+ model, firmware 1.4.

1.2 Pipette Overview

Before using the pipette for the first time, please review the instrument components, user interface and pipette controls as described on the next few pages.



1. USB / Charger Port
2. Display
3. Soft Keys
4. Finger Hook
- RFID Tag
- Serial No
5. Joystick
(also called Thumbstick)
6. Tip Ejector Button
7. Shaft
8. Tip Ejector Arm
9. Disposable Tip

Figure 1: E4 XLS Single-channel Pipette

Display

The high performance electronic color display is the user interface for E4 XLS+. Screen navigation, pipette operation, settings and options selections are performed using the soft keys and joystick controls. Common screen information and the available functionality in menu and mode screens are shown in Figure 2.

1. Current menu or mode
2. Menu level, current operation or page number
3. Time
4. Battery charge indicator
5. System icon display
6. Carousel of modes
7. Menu Level I and Level II access icon
8. Soft key functions
9. Joystick navigation icon
10. Tip Volume Indicator

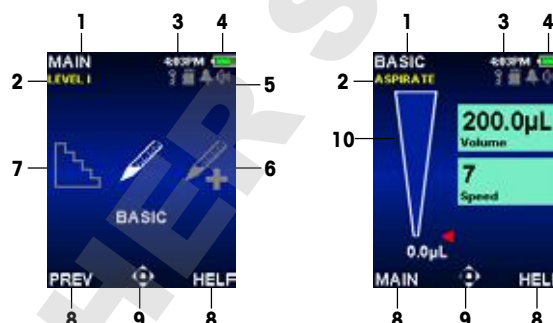







Figure 2: Display Components: Level I Menu (left), Basic Mode (right)

Navigation

Navigation is done using the soft keys and the joystick control. The functions of the soft keys and joystick control change according to the menu or mode displayed. In this manual we use the convention of showing the image of the control to denote the action of selecting that control. As examples, the  key means move the joystick to the right, **OPTIONS** means "Select the OPTIONS soft key".

-  or  to view and select menu items
- ,  or  to enter the selected Basic Mode or Level II Menu

Soft Key Functions

There are two soft keys below the display. Left and right soft key functions change according to the current menu or mode screen. Functions are shown in the display above each soft key, and the available joystick controls are highlighted in the navigation icon. In the example in Fig. 3 there is a function shown for the left soft key (RESET) but not for the right one.

Left soft key items that can be displayed:

- **MAIN:** Displays the Main Menu for the menu level selected
- **PREV:** Returns to the previously-used mode, allows toggling between modes
- **DONE:** Exits Settings and Options screens after activity is done
- **RESET:** Empties tip and resets operation
- **RETURN:** Exits a Help screen and returns to the previous screen
- **CONT:** Exits notification messages and allows the current operation to continue

Right soft key items that can be displayed:

- **OPTIONS:** Available mode options
- **CANCEL:** Cancels and exits the current action without saving changes



Figure 3: E4 XLS Controls

- **HELP:** Displays mode and menu information and operating instructions
- **LOAD:** Load a Preset
- **SELECT:** Select a Preset or Protocol
- **SAVE:** Save a Preset or Protocol
- **DELETE:** Delete a Preset or Protocol

Joystick (Thumbstick) Controls

Rainin recommends that users practice menu and mode screen navigation in order to familiarize themselves with the joystick's ease of use and sensitivity in control.

Press and click the center button to:

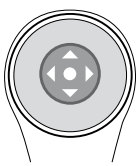

- Aspirate and dispense
- Access menu items
- Edit settings or options
- Choose and save selections

Note: The circle icon (●) represents a center-press control in this manual.

Move the joystick control left or right to:

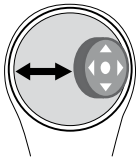

- Navigate between menu items and pages
- Access Settings screens
- Make coarse setting value adjustments

Note: Left (◀) and right (▶) arrows represent these joystick controls in this manual.

Move the joystick control up or down to:

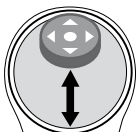

- Aspirate and dispense
- Navigate between settings and options
- Make fine setting value adjustments

Note: Up (▲) and down (▼) arrows represent these joystick controls in this manual.

1.3 Getting Started

Battery

The pipette is shipped without the main battery installed, and with the back-up coin cell battery insulated so that it will be fully-charged when you need it. To get started, open the battery cover on the back of the pipette head and remove the pull-tab shown in Figure 4 - the pull tab is used to insulate the battery during shipping.



Figure 4: Insulating pull-tab

Locate the main battery and install it as shown in Figure 5, then you will see a screen advising you to set your local time and language (the default language is English). Setting preferences is shown in section 1.9 - Setup Mode. Make sure the label faces outward and the battery is in the same orientation as shown in the photo. Replace the battery door.



Figure 5: Installing the main battery

Charge the battery for at least 15 minutes before using the pipette for the first time. Pipettes can be charged using the Wall Power Supply included with the pipette, the optional Rapid Charge Stand or with a computer using the optional USB cable. If the Wall Power Supply is used, E4 XLS+ can be operated while it is charging, as shown in Figure 6. (Rainin does not recommend operating the E4 XLS+ when the pipette is connected to a computer for charging. Please refer to “Battery Charging” on page 44 for more information on charging the battery as well as installing and using the Wall Power Supply, Rapid Charge Stand and the optional USB cable.



Figure 6: Using E4XLS while connected by the power cord

Power Up

Press one of the soft keys to turn the pipette on. It will initialize and show the start-up screen momentarily before displaying the Level I Menu. See Figure 7. Note that your start-up screen may have different text than this image.



Figure 7: Start-up Screen

Basic Operation — Using Basic Mode

Rainin recommends learning basic pipetting operations as well as the selection and editing of settings in Basic Mode first before moving on to advanced operational modes. Rainin also recommends that users practice aspiration and dispense with water first prior to working with valuable samples.

At any time during operation:

- **RESET** empties the tip and resets the pipette operation to **ASPIRATE**.
- **MAIN** displays the menu the mode was accessed from.
- **HELP** provides general information for the highlighted setting. Operating instructions can be found in the Help for the operating screen.

Options and Settings

- Options: None
- Settings: Single Volume, Single Speed
- Blowout: Automatic and Manual

Setup — Select Mode and Settings

1. In the Main Menu, ◀ or ▶ to highlight **BASIC** (Figure 8 left).
2. ●, ▲ or ▼ to enter Basic Mode (Figure 8 right).



Figure 8: Basic Mode Highlighted in Level I Menu (left), Basic Mode Operating Screen (right).

3. ▶ to enter the Settings screen. The first setting box in the screen, Volume, will be highlighted. This is indicated by a white border around the settings box (Figure 9 left). ▲ or ▼ to navigate between and highlight other settings.
4. ● or ▶ to edit the volume setting. The settings box will turn white to indicate it is in edit mode (Figure 9 right). ◀ or ▶ for coarse volume adjustment and ▲ or ▼ for fine volume adjustment. Hold the joystick in place to quickly scroll through values.

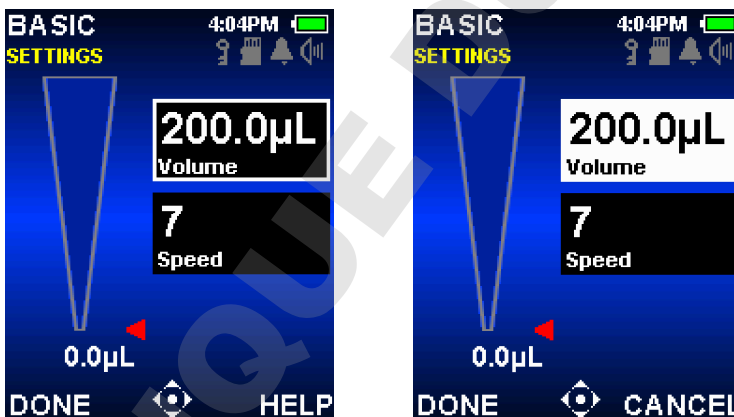

Figure 9: Basic Mode: Volume Highlighted (left), Volume in Edit Mode (right).

5. **DONE** or ● to save the volume setting. **CANCEL** to exit without saving changes. The next setting, speed, will be highlighted (Figure 10 left).
6. ● or ▶ to edit the Speed Setting. The settings box will turn white to indicate it is in edit mode (Figure 10 right). In Basic Mode, the same speed is used for both aspirate and dispense. ◀ or ▶ for coarse speed adjustment of 1, 5 or 10 and ▲ or ▼ for fine adjustment in single digits. Hold the joystick in place to quickly scroll through values.

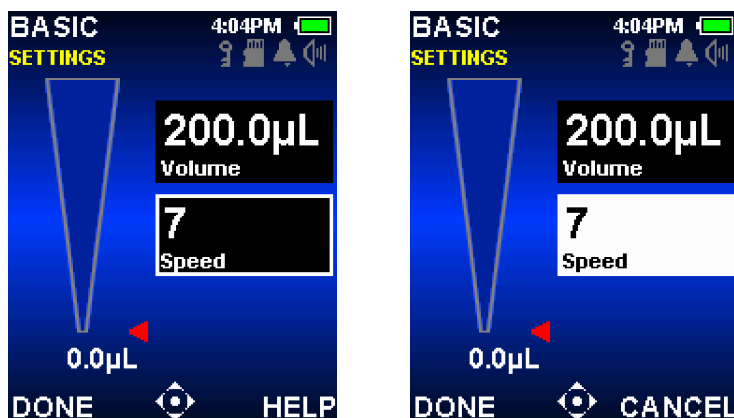

Figure 10: Basic Mode with Speed Highlighted (left), and Speed in Edit Mode (right).

7. **DONE** or ● to save the Speed Setting. **CANCEL** to exit without saving changes.
8. **DONE** to exit the Settings screen and return to the operating screen.

If Basic Mode is exited, all settings are retained when the mode is accessed again.

Aspiration

The mode operation will flash **ASPIRATE** indicating E4 XLS+ is ready to aspirate sample. The joystick controls used for aspiration will also flash in the navigation icon (Figure 11).



Figure 11: Basic Mode Aspirate Operation.

1. Attach a new Rainin tip. Press the shaft into the tip with only enough force to make a good seal.
2. Hold the pipette vertically or within 20 degrees of vertical. Place the tip into the sample at the recommended immersion depth – see section 1.6.3 on page 16.
3. ● or ▲ to aspirate the sample. It is not necessary to hold the joystick in place, E4 XLS+ will automatically complete the operation. The Tip Volume Indicator will mimic sample aspiration into the tip, and its red guide arrow and active volume display will adjust accordingly.
4. Pause for approximately one second (longer for large-volume pipettes) to ensure that the full volume of sample is drawn into the tip.
5. Withdraw the tip from the sample. If any liquid remains on the outside of the tip, touch it off carefully, taking care not to touch the tip orifice.

Dispense

The mode operation will now flash **DISPENSE** indicating E4 XLS is ready to dispense sample. The joystick controls used for dispense will also flash in the navigation icon (Figure 12).



Figure 12: Basic Mode Dispense Operation.

1. Touch the tip end against the side wall of the receiving vessel. ● or ▼ to dispense the sample. It is not necessary to hold the joystick in place, E4 XLS will automatically complete the operation. The Tip Volume Indicator will mimic sample dispense from the tip, and its red guide arrow and active volume display will adjust accordingly. Wait 1 second for 2–300 µL volumes and 1–2 seconds for 1000 µL volumes or higher.
2. Withdraw the tip, sliding it along the wall of the vessel.
3. If needed, ▼ or **RESET** for tip blowout. ▼ or **RESET** again as needed for more blowout(s) (Figure 13). For viscous solutions, pause before blowout. Note that Blowout is automatic, but you can also perform blowout manually to repeat. You can delay piston return time if desired by holding down the joystick.

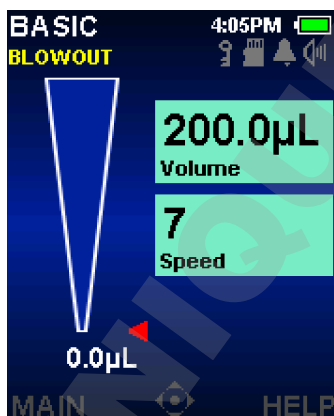

Figure 13: Basic Mode Blowout Operation.

4. Press the tip ejector button lightly to discard the tip. To prevent carry-over, use a new tip for each sample.

1.4 Menus and Modes

Overview

E4 utilizes two menu levels that allow user selection of pipetting modes and provide access to general pipette information and settings:

- **Level I Menu:** Allows selection of common operational modes and access to the Level II Menu. See Figure 14. The default Level I Menu operational mode selections include Basic Mode, Advanced Mode, Multi-Dispense Mode, Manual Mode and Setup Modes.
- **Level II Menu:** Provides selection of additional modes, pipette and personalization settings, service information and options, and access to Level I menu. The default selection includes Reverse, Titrate, Dilute, Service, Admin Modes, Power Off and Remote. Purespeed will also show on 20, 200, 1000, and 1200 μL models.

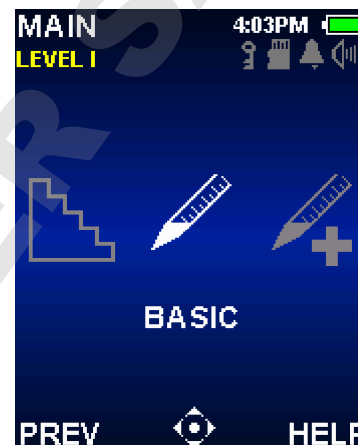

Figure 14: E4 XLS Controls

The following operational modes offer a wide variety of pipetting capabilities:

- **Basic Mode:** Basic pipetting operation. Selection of a single volume and one aspirate/dispense speed.
- **Advanced Mode:** Provides all E4 XLS advanced pipetting options such as Mix and Volume Sequencing.
- **Multi-Dispense Mode:** Provides multi-aliquot dispensing with user-settable automatic dispense intervals.
- **Manual Mode:** Provides joystick control of E4 XLS that simulates manual pipette operation. Fine control of precise volume increments allows aspiration and dispense of measured sample volumes.
- **Reverse Mode:** Aspirates the selected volume along with the pipette blowout volume. Recommended for dense or volatile liquids.
- **Dilute Mode:** Provides in-tip dilution of multiple sample volumes.
- **Titrate Mode:** Performs titration through measured dispensing. Allows an initial rapid dispense followed by precise control of the remaining titration volume.
- **PureSpeed™ Mode:** Performs sample preparation utilizing Rainin PureSpeed tips. For more information see Pure Speed User Manual on the E4 User Manual disc or www.mt.com/purespeed.
- The following modes provide preference, configuration and access options for the pipette.
- **Setup Mode:** Provides basic personalization of pipette settings including display brightness, sleep timeout, volume level, time/date setup, language, and alarms.
- **Admin Mode:** Provides configuration and access control to pipette settings. Admin allows you to control use of your pipette by hiding, locking, and unlocking pipetting modes, date, time, alarms, and settings, with optional passcode protection. Save backups of the entire configuration of the pipette after modifying settings in other modes.
- **Service Mode:** Provides important instrument information including last service date, service log, serial number, manufacturing date, model number, and more. Information is protected for GLP compliance.

1.5 Options and Settings

The list of common options and settings is provided in the table below. A detailed description of these and other mode-specific options follows.

| | Fixed Volume | Volume Sequencing | Single Speed | Multi-Speed | Mix | Blowout Control | Cycle Counter | Auto Pace | Mode Presets |
|----------------|--------------|-------------------|--------------|-------------|-----|-----------------|---------------|-----------|--------------|
| Basic | | | ■ | | | | | | |
| Advanced | ■ | ■ | | ■ | ■ | ■ | ■ | | ■ |
| Multi-dispense | ■ | ■ | | ■ | | ■ | | ■ | ■ |
| Manual | ■ | | ■* | | | | ■ | | ■ |
| Reverse | ■ | ■ | | ■ | | ■ | ■ | | ■ |
| Dilute | | ■ | | ■ | ■ | ■ | ■ | | ■ |
| Titrate | | | | ■ | | | ■ | | ■ |

*Speed in Manual Mode is variable.

Options

If pipetting options are available in an operational mode, **OPTIONS** will be shown in the operating screen.

Options can be selected as follows:

1. **OPTIONS** to access the Options screen (Figure 15 left).
2. ▲ or ▼ to navigate between and highlight an option. When more than one page of options is available, **Options 1 of X** is displayed in the upper left corner of the screen. To navigate between pages, ▲ or ▼ at the first or last option on a page. (Figure 15 center and right).
3. ● or ► to turn an option on or off.
4. **DONE** or ◀ to save changes and return to the operating screen. When an option is on, an associated option icon will be displayed in the lower left corner of operating screen and/or an additional settings box will be shown.

If the operational mode is exited, all options are retained when the mode is accessed again.

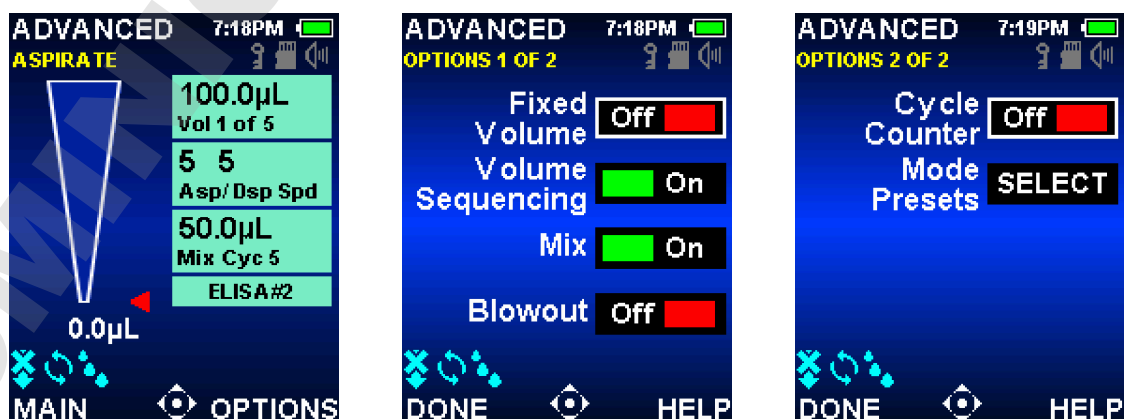

Figure 15: Options in Advanced Mode: **OPTIONS** Soft Key in Operating Screen (left), Options 1 of 2 (center) and Options 2 of 2 (right)

Volume Options

Fixed Volume. Provides the option of selecting up to 14 preset volumes from a table in the Volume Setting box. When this option is turned on, the Fixed Volume Setting box will display in the operating screen. This option is useful for routine work where standard volumes are used repetitively. Note repeat pressing ◀ will toggle through the values.



Volume Sequencing. Provides the option of selecting up to 16 preset volumes in series from a table in the Volume Setting box. This option is useful for preparative protocols that require multiple samples at various volumes. When this option is turned on, the Volume Sequencing icon and Setting box will display in the operating screen.

Note: Only one volume option can be on at a time. For example, if Fixed Volume is turned on when Volume Sequencing is already on, E4 XLS+ will automatically turn Volume Sequencing off. If both options are off, the mode defaults to Single Volume.

Mix Option



Provides in-tip mixing of dispensed samples. When this option is turned on, the Mix icon and Mix Setting box will display in the operating screen. Users can specify mix volume and either manual mixing or up to 99 automatic mix cycles.

Blowout Option



Allows adjustment of blowout function in specific modes. When this option is off, the Blowout Off icon will display in the operating screen. Users can still perform manual blowout(s) when the Blowout option is off.

Cycle Counter Option

15
Cycle Count

Counts each pipetting cycle which consists of one aspirate and one dispense and blowout operation. When this option is on, a Cycle Count Setting box is displayed in the operating screen.

Auto Pace Option



Provides automatic dispensing of aliquots at user-settable time intervals between 0.1 and 30 seconds. Available in Multi-dispense Mode only. When this option is on, the Auto Pace icon is displayed in the operating screen.

Mode Preset Option

5 Preset(s)

Mode Preset allows for saving and rapid recall of favorite protocols.

Allows saving entire mode setting to a Preset file. Preset files can be named, edited, and deleted. Saved Mode Presets can be viewed and selected in the Settings screen. Mode Presets are specific to the Mode in which they were created.

Settings

The pipette settings available in each operational mode are displayed in the boxes along the right side of the operating screen. Volume and speed settings are common to all operating modes. Cycle count, mix settings and Mode Presets are displayed if the corresponding option is available and has been turned on in the operational mode.

In general, settings can be selected and changed as follows:

1. ► to access the Settings screen.
2. ▲ or ▼ to navigate between and highlight a setting.
3. ● or ► to edit.
4. ◀ or ▶ for coarse value adjustment and ▲ or ▼ for fine value adjustment. Hold the joystick in place to quickly scroll through values.

Some option-specific settings may require additional steps. If the operational mode is exited, all settings are retained when the mode is accessed again.

Volume Settings

Allow users to set the volume of sample to be aspirated. Minimum and maximum volumes are dependent on the E4 XLS pipette model. The type of Volume Setting displayed depends on what options are turned on or off in the operational mode.

200.0ul
Volume

Single Volume. Allows one volume to be set and used for aspirate/dispense. When this setting is active, **Volume** is displayed in the **Volume Setting** box. This is the default volume setting for all operational modes, and the only volume setting available in Basic Mode.

30.0ul
Fixed Vol 4

Fixed Volume. Allows one of 14 preset volumes to be selected from a volume table. This setting is shown only when the Fixed Volume option is on. When this setting is active, **Fixed Vol X** is displayed in the volume setting box. For example, **Fixed Vol 3** indicates the volume shown is the third volume selection in the table.

100.0ul
Vol 1 of 16

Volume Sequencing. Allows up to 16 preset volumes to be selected for use in series from a volume table. This setting is shown only when the Volume Sequencing option is on. When this setting is active, **Vol X of X** is displayed in the volume setting box. For example, **Vol 2 of 4** indicates the volume shown is the second of four volumes in the series selected in the table. The volume value and number will increment as each cycle completes.

Speed Settings

Allow users to set aspirate, dispense and mix speeds from 1 (slow) to 10 (fast). High speed settings are best for aqueous samples and lower speed settings are best for viscous, foaming, delicate or shear-sensitive samples. The maximum speed settings for large-volume E4 XLS Basic Models are limited to prevent 'fountaining', or air intake, during aspiration. See Appendix A for a complete speed table.

10
Speed

Single Speed. Allows one speed value to be set which is used for both aspirate and dispense. This is the only speed setting available in Basic Mode.

10 10
Asp/ Dsp Spd

Multi-Speed. Allows aspirate, dispense and mix speed settings to be set individually. Displays aspirate and dispense speeds (**Asp/Dsp Spd**) initially. During operation, the set value and current operation (**Asp Speed**, **Dsp Speed** or **Mix Speed**) will be shown in the settings box as each action is carried out.

Cycle Count

15
Cycle Count

Cycle is complete aspiration and dispense followed by blowout. Displays the operational mode's current cycle count, which increments after each cycle completes. Cycle count can be set to any value between 0 and 99,999. This setting is shown only when the Cycle Counter option is on.

Mix

40.0ul
Mix Cyc #

Allows users to perform in-tip mixing after dispense. A mix volume, up to 99 automatic mix cycles or manual mixing can be selected. This setting is shown only when the Mix option is on. Minimum and maximum volumes are dependent on the size of the E4 XLS pipette. When auto-

40.0ul
Mix Manual

matic mix cycles are used, the set volume and number of mix cycles (**Mix Cyc X**) are shown in the settings box. The cycle number will increment as each mix cycle completes until the set number of cycles is reached. When manual mixing is used, the set volume and **Mix Manual** are shown in the settings box.

Preset Selector

5 Preset(s)

Allows user to select a Mode Preset file, if one or more has been saved. The display shows how many presets are available and which one is currently loaded (if any). Activating this setting box allows users to scroll through and select any available preset with the joystick.

1.6 Using the Pipette

1.6.1 Pipetting Guidelines

E4 XLS+ pipettes incorporate several features to enhance pipetting consistency. In addition, these guidelines should also be followed:

- Use a consistent immersion depth
- Pipette vertically or within 20 degrees of vertical
- Pre-rinse the tip twice by aspirating and dispensing sample before actual pickup
- Do not invert or lay the pipette flat with liquid in the tip

More information on Good Pipetting Technique, including a Lab Poster, can be found on the MT website: www.mt.com/rainin

1.6.2 Tip Selection and Mounting

Rainin pipettes and tips are designed together as a pipetting system. E4 XLS+ pipettes are calibrated with Rainin tips. Performance to published specifications can only be guaranteed when Rainin tips are used.

To mount a tip, press the E4 XLS shaft into the end of the tip with light force. With both LTS and traditional versions, the tip will seal properly on the shaft with minimal force — do not use more force than is required.

1.6.3 Tip Immersion Depth

The recommended depth for tip insertion into the sample for each model is shown below:

| Nominal Volume | Volume Range | Immersion Depth |
|--------------------|---------------------------|-----------------|
| 10 μL | 0.5 to 10 μL | 1–2 mm |
| 20 μL | 2 to 20 μL | 2–3 mm |
| 100 μL | 10 to 100 μL | 2–3 mm |
| 200 μL | 20 to 200 μL | 3–6 mm |
| 300 μL | 20 to 300 μL | 3–6 mm |
| 1000 μL | 100 to 1000 μL | 3–6 mm |
| 2000 μL | 200 to 2000 μL | 3–6 mm |
| 5000 μL | 500 to 5000 μL | 6–10 mm |
| 10 mL | 1 to 10 mL | 6–10 mm |
| 20 mL | 2 to 20 mL | 6–10 mm |

Tip immersion depth is critical. If the recommended depths are exceeded, the volume measured may be inaccurate and possibly out of specification. The tip angle is also important. The pipette should always be used in a position within 20 degrees of vertical as shown in 16.

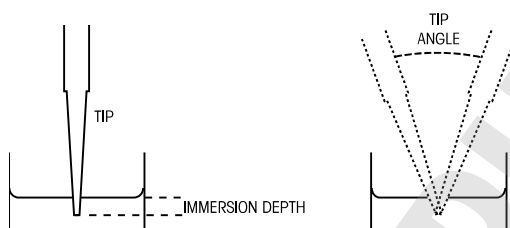

Figure 16: Tip Immersion Depth and Tip Angle

1.6.4 Sleep Mode and Power Shutdown

E4 XLS+ is equipped with display and sleep timeout features, both of which assist in conserving battery life - Sleep Mode reduces power consumption by 98%. E4 XLS+ will automatically sleep after a set period.

- **Display Timeout.** Dims the intensity of the display after a user-specified period of inactivity. To wake E4 XLS+ from a display timeout, press either soft key or move the joystick in any direction.

Note: The soft key or joystick action taken to exit a display timeout will return the E4 XLS+ to ready mode only. The associated soft key function or joystick command will not initiate.

- **Sleep Timeout.** Powers the display off and puts the unit into low power state after a user-specified period of inactivity. To wake E4 XLS+ from a sleep timeout, press either soft key. The pipette will initialize and show the splash screen momentarily before returning the display to the last screen accessed.

Refer to "Setup Mode" in section 9 for information on how to change the time setting for these timeout features.

Shutdown

Besides Sleep mode, the E4 XLS+ can also shut down completely. The E4 XLS+ automatically shuts down after 16 hours of non-use. If you wish to shut it down earlier, push and hold both soft keys simultaneously. After 3 seconds, the units beeps twice and a warning screen notifies you that you are about to shut down the unit. Press

CONT to shut down. Alternately, enter "POWER OFF" mode on Level II of the Main Menu. To turn on unit, press any soft key.

1.6.5 Help

On-screen Help is available to assist users with step-by-step operation and provide detailed information for a particular screen, menu item, setting or option.

- **Menu Help.** To get more information on a specific carousel menu item, highlight the item and select **HELP**.
- **Settings and Options Help.** To get more information on a specific setting or option in the current screen, highlight the item and select **HELP**.

Note: For all advanced operational modes, operating instructions can be found in the Help for the first setting in the mode's operating screen.

- **General Information.** In some screens, general information and/or operating instructions can be accessed directly without having to highlight a particular item. In these screens, **HELP** will be an available function as soon as the screen is accessed.

Note: In Basic Mode only, operating instructions can be found in the general help for the mode's operating screen.

Select **RETURN** to exit Help and return to the previous screen.

1.6.6 Filter

5000 μ L, 10 mL, and 20 mL pipettes use a filter in the end of the shaft. This helps prevent liquid from entering the shaft and contaminating the piston should the plunger snap up during aspiration. Using a filter is recommended when pipetting large volumes. The filter should be replaced if it gets wet.

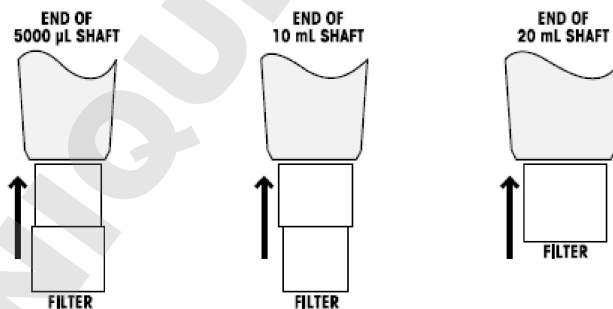

Figure 17: Filter Orientation

The 5000 μ L and 10 mL pipettes use the same filter, as shown in the diagram above:
5000 μ L: small diameter into the shaft. 10 mL: large diameter into the shaft.

Filter part numbers are 6190-164 17001944 (pack of 100) and
 6190-165 17001945 (pack of 1000).

The filter for the 20 mL model is a cylinder.

Part numbers: 6190-221 17001951 (pack of 100),
 6190-222 17001952 (pack of 500).

1.7 Volume Ranges and Increments

Volume ranges and increments for each model are shown in the following tables:

Single Channel E4 XLS+ Models

| Volume (µL) | Adjustable Range (µL) | Recommended Range (µL) | Increment (µL) |
|-------------|-----------------------|------------------------|----------------|
| 10 | 0.1 to 10 | 0.5 to 10 | 0.01 |
| 20 | 0.2 to 20 | 2 to 20 | 0.02 |
| 100 | 1 to 100 | 10 to 100 | 0.1 |
| 200 | 2 to 200 | 20 to 200 | 0.2 |
| 300 | 3 to 300 | 20 to 300 | 0.2 |
| 1000 | 10 to 1000 | 100 to 1000 | 1 |
| 2000 | 20 to 2000 | 200 to 2000 | 2 |
| 5000 | 50 to 5000 | 500 to 5000 | 5 |
| 10 mL | 0.1 to 10 mL | 1 to 10 mL | 10 |
| 20 mL | 0.2 to 20 mL | 2 to 20 mL | 20 |

Multichannel and Adjustable Spacer Models

| Volume (µL) | Adjustable Range (µL) | Recommended Range (µL) | Increment (µL) |
|-------------|-----------------------|------------------------|----------------|
| 10 | 0.1 to 10 | 0.5 to 10 | 0.01 |
| 20 | 0.2 to 20 | 2 to 20 | 0.02 |
| 50 | 0.5 to 50 | 5 to 50 | 0.05 |
| 100 | 1 to 100 | 10 to 100 | 0.1 |
| 200 | 2 to 200 | 20 to 200 | 0.2 |
| 300 | 3 to 300 | 20 to 300 | 0.2 |
| 1200 | 20 to 1200 | 100 to 1200 | 1 |

1.8 Sound Alerts

General Sound Alerts

- Aspiration complete: High-tone ding
- Dispense complete: Mid-tone ding
- Blowout complete: Low-tone ding
- Reset activated: Two high-tone beeps
- Reset complete (piston in home position): Low-tone ding
- Soft key function accessed: Short click

- Menu navigation: Swoosh
- Menu item selected: Short click
- Setting or option selection: Short click
- Setting value or option edit: Short click
- Setting error (min/max setting has been reached): Buzz
- Cancel: Swoosh
- Low battery warning: Two high-tone beeps
- Service Alarm: Two high-tone beeps

Mode-Specific Sound Alerts

- Multi-Dispense Mode: A second low-tone ding will sound after the last aliquot is dispensed.
- Manual Mode: Aspirate and dispense complete alerts will sound only when the value set in the Volume Setting is fully aspirated or dispensed.
- Titrate Mode: After Fast Dispense, the dispense complete alert will sound again only if the value set in the Volume Setting is fully dispensed.

1.9 Setup Mode



Setup Mode allows users to personalize general pipette settings. User-settable service alarms can also be activated. The default menu level for Setup Mode is Level I. To access Setup Mode, ◀ or ▶ in the Main Menu to highlight **SETUP** and ●, ▲ or ▼ to enter.

Navigation of Setup Pages

- ▲ or ▼ to move between and highlight a setting
- To move between pages, ▲ or ▼ at the first or last setting on a page or ◀ at any time. The current page number is displayed in the upper left of each screen.
- **HELP** for a detailed description of the highlighted item
- **MAIN** to return to the Main Menu

Sound and Display Settings

Available sound, display and timeout settings are shown in Figure 18.

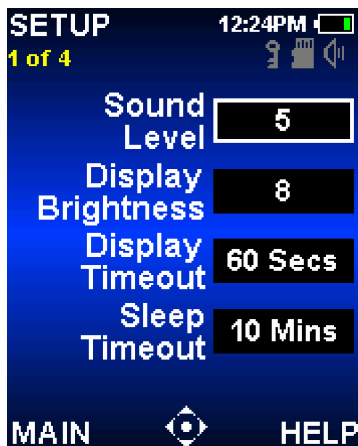

Figure 18: Setup Mode: Page 1 of 4

Sound Level

This is the volume setting for audible activity alerts. Volume levels between 1 and 10, or Off, can be selected.

1. ● or ► to edit.
2. ◀ or ▶ for coarse adjustment of Off, 5 or 10 and ▲ or ▼ for fine adjustment in single digits. ▼ or ◀ at 1 for Off. Volume level is shown on the System icon display.
3. **DONE** or ● to save.

Display Brightness

This is the light intensity setting for the display. Values between 1 and 10 can be selected, where 1 is the dimmest and 10 is the brightest setting.

1. ● or ► to edit.
2. ◀ or ▶ for coarse adjustment and ▲ or ▼ for fine. The screen brightness will automatically adjust as the setting is changed.
3. **DONE** or ● to save.

Display Timeout

The Display Timeout will dim the display after a period of inactivity in order to conserve battery life. Time intervals between 5 and 120 seconds, or Never, can be selected.

Note: To wake E4 XLS+ from a Display Timeout, press either soft key or move the joystick in any direction.

1. ● or ► to edit.
2. ◀ or ▶ for coarse adjustment and ▲ or ▼ for fine.
3. **DONE** or ● to save.

Sleep Timeout

The Sleep Timeout will power the display off after a period of inactivity in order to conserve battery life. Time intervals between 1 and 60 minutes can be selected.

Note: If charging, the pipette will not enter a sleep timeout if a cycle is incomplete — for example, when a sample has been aspirated but not yet dispensed. To wake the pipette from a Sleep Timeout, press either soft key. If not charging, the pipette will not enter a sleep timeout if a cycle is incomplete for an additional 15 minutes. The interrupted cycle is recoverable for up to 18 hours when not charging.

1. ● or ► to edit.
2. ◀ or ► for coarse adjustment and ▲ or ▼ for fine.
3. **DONE** or ● to save.

Time and Date Settings

Available time and date settings are shown in Figure 19.



Figure 19: Setup Mode: Page 2 of 4

Time

Shows the current time in a 24-hour, HH:MM:SS format. Time is displayed at the top right of all screens.

1. ● or ► to edit.
2. Hour will be selected initially. ◀ or ► to navigate between hour, minute and second settings.
3. ▲ or ▼ to change value.
4. **DONE** or ● to save.

Date

Shows the current date using the current Date Format Setting.

1. ● or ► to edit.
2. The first field will be selected initially. ◀ or ► to navigate between the other two date fields.
3. ▲ or ▼ to change value.
4. **DONE** or ● to save.

Time Display

This is the format of the on-screen time display. Select 24- or 12-hour formats or None to turn the time display off.

1. ● or ► to edit.
2. ▲ or ▼ to select display format.
3. **DONE** or ● to save. The format of the time display in all screens will update immediately.

Date Format

This is the year, month and day format for the Date Setting. M/D/Y, Y/M/D, and D/M/Y formats can be selected.

1. ● or ► to edit.
2. ▲ or ▼ to select format.
3. **DONE** or ● to save. The Date Setting will update automatically.

User Preference Settings

Available user preference settings are shown in Figure 20.



Figure 20: Setup Mode: Page 3 of 4

Language

Users can select one of the following languages: English, Japanese, Chinese, French, Spanish or German.

1. ● or ► to edit.
2. ▲ or ▼ to select language.
3. **DONE** or ● to save. The text displayed in all screens will update to the new language immediately.

Owner

This setting identifies the pipette owner. Users can enter up to 16 characters. The owner will also display in the splash screen.

1. ● or ► to edit.
2. Use joystick to select characters in Texteditor popup screen. Use the bottom left icon to select lowercase letters, numbers or symbols.
3. **DONE** to save.



Mode Levels

The operational modes available for selection in either the Level I or Level II Menu can be customized by the user. Mode access can be moved between menu levels as needed. Once a mode's menu level is changed, it will be available only in the menu it was assigned to. The order of appearance on the carousel can also be changed. Modes that have been hidden in Admin Mode (Section 1.10) will not appear in the list. Locked modes also show a padlock icon.



1. ● or ► to view the mode menu table.
2. ▲ or ▼ to highlight a mode's level.
3. ● or ► to edit.
4. ◀ or ▶ to select Level I or Level II Menu.
5. ▲ or ▼ to change order of appearance on carousel.
6. **DONE** or ● to save.
7. **DONE** to exit table. Modes will immediately display as menu items in the selected menu.



Alarms

Users can set service alarms based on number of cycles executed or days in use. Alarm options and settings are shown in Figure 21.

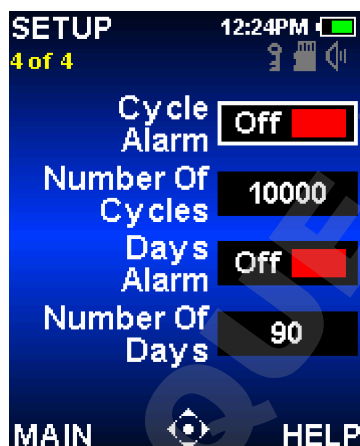

Figure 21: Setup Mode: Page 4 of 4

Cycle Alarm

The Cycle Alarm will notify users that pipette service is due after a set number of aspirate/dispense cycles have been executed since last service (see Service Mode). To set a Cycle Alarm:

1. ● or ► to turn the Cycle Alarm on.
2. ▼ to highlight the Number of Cycles Setting.
3. ● or ► to edit.
4. ◀ or ▶ for coarse adjustment and ▲ or ▼ for fine adjustment. Values between 1000 and 1,000,000 can be set.
5. **DONE** to save changes.

When the value set in the Number of Cycles Setting has been reached, the pipette will present the following:

- An on-screen Service Alarm notification

Note: To exit a notification message, select **CONT**

- The Service Alarm icon will appear on the System Icon display
- These notifications will continue to display until the Cycle Alarm is turned off, the Number of Cycles Setting is reset, or service is performed.



Days Alarm

The Days Alarm will notify users that pipette service is due after the pipette has been in use for a set number of days. To set a Days Alarm:

1. ●, ◀ or ▶ to turn the Days Alarm on.
2. ▼ to highlight the Number of Days Setting.
3. ● or ▶ to edit.
4. ◀ or ▶ for coarse adjustment and ▲ or ▼ for fine adjustment. Values between 1 and 1,000 can be set.
5. **DONE** to save changes.

When the value set in the Number of Days Setting has been reached, E4 XLS will present the following:

- An on-screen Service Alarm notification

Note: To exit a notification message, select **CONT**

- The Service Alarm icon will appear on the System Icon display

These notifications will continue to display until the Days Alarm is turned off, the Number of Days Setting is reset, or service is performed.



1.10 Admin Mode

Overview



Admin Mode allows you to control access to pipette settings and to personalize pipette configuration. This mode can be a helpful GLP/GMP/GCP compliance tool to enhance adherence to lab protocols and to prevent unauthorized changes to pipette settings. Admin Mode can be a useful tool for all users to simplify the pipette configuration, or as a convenient way to save personalized settings with a shared instrument.

The Mode Access feature allows individual Modes to be Unlocked (usable and modifiable), Locked (usable but non-modifiable) or Hidden (inaccessible).

Service related settings such as Date/Time and Alarms can be individually Locked to prevent changes to the settings.

The administrator can Passcode-protect access to Admin mode, thus preventing unauthorized access to changing pipette settings.

The administrator can also save the entire Settings profile of the pipette as a User Preset, or restore the pipette to Factory settings.

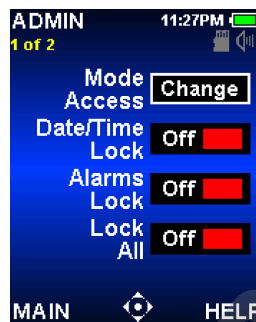

A: Admin Page 1



B: Admin Page 2

General Navigation

1. ◀ or ▶ to highlight Admin mode on Level II of the Main menu.
2. ●, ▲ or ▼ to access Admin mode.
3. ▲ or ▼ to scroll through different features (Figures A, B).
4. ◀ to jump from one page to the next.
5. ● or ▶ to access or turn individual features ON/OFF.

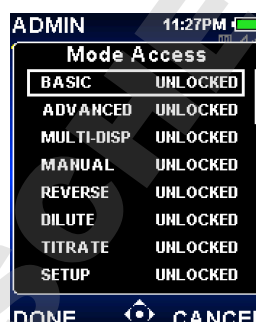

C: Mode Access Select

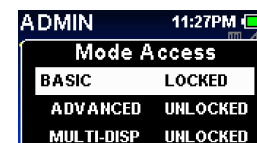

D: Mode Access Select

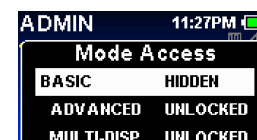

E: Mode Access Select

Setting Mode Access

Use this feature to simplify and control the pipette configuration by altering the accessibility of individual modes. Mode access can be: Unlocked (usable and modifiable), Locked (usable but non-modifiable) or Hidden (inaccessible). The settings and options of a locked mode can be viewed, but not modified. Locking Setup mode will prevent unauthorized changes in Setup to pipette configuration. When it is locked, the Setup screens can also still be viewed, which can be helpful if the user wants to check how certain features are set, such as alarms. This is not possible if Setup is Hidden.

Admin mode cannot be hidden or locked (but can be passcode protected, see section below).

1. ● or ▶ to CHANGE to modify mode access (Figure A).
2. ▲ or ▼ to highlight mode(s) of interest (Figure C).
3. ● or ▶ to edit access setting (Figure D).
4. ◀▶, ▲ or ▼ to scroll through three options: Unlocked, Locked, or Hidden (D-E).
5. ● or DONE when mode access is set.
6. Continue modifying other modes until finished.
7. DONE to return to Admin menu.

A Locked Mode will have a padlock icon on the operating screen in the bottom left corner. A Mode can be locked with a Mode Preset already loaded, however other Mode Presets cannot be accessed.

Date/Time and Alarm Lock

Turn these locks on (Figure A) to prevent changes to the Date/Time and Alarm settings in Setup mode. Useful for GLP compliance when on-board service alarms are being used, but you want to leave the rest of the pipette configuration unlocked.

Lock All

Turn this function on (Figure A) to prevent changes to any setting outside of Admin Mode. Useful for SOP compliance and adherence when the pipette is utilized for repetitive procedures that do not vary often. Note: This will only prevent changes to settings-any Mode that is not hidden (see Mode Access above) can still be used. A pad-lock icon appears on the system icon display.

Passcode Feature

Use a passcode to prevent unauthorized access to the Admin functions.

Setting or changing a Passcode

1. ● or ► SET on page 2 of Admin mode to enter a new passcode (Figure B). If a passcode is currently active, it will be overridden by the new one.
2. Select a passcode. Use ◀, ▶, ▲ or ▼ to highlight numbers, ● to select a number. Passcode must be four digits long. DONE when complete (Figure F).
3. CONT to confirm your passcode.
4. A new "Passcode Protection" field will appear beneath the "Set Passcode" field on page 2 of Admin mode showing "ON" status (Figure G). A key icon in the system icon display area also indicates that a passcode is currently active (Figure G).
5. The active passcode is always the last one that was confirmed.
6. MAIN to exit Admin mode and enable the passcode protection.
7. Please store your passcode where you and approved colleagues can access it!

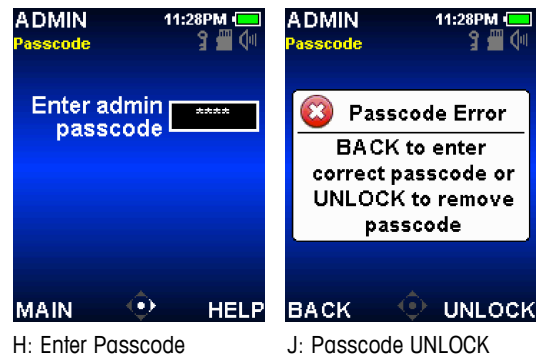

Removing Passcode Protection from Admin Mode

1. In the "Passcode Protection" field, ● or ► ON to turn passcode OFF (Figure G).
2. CONT to confirm passcode removal.

Entering Admin Mode with Passcode Protection

After a passcode is set, re-entry into Admin mode requires entering the passcode (Figure H).

If you forget your passcode, select UNLOCK from the passcode screen and call technical support (800-4-RAININ) in the USA or your local METTLER TOLEDO representative (Figure J).

User Preset Feature

A User Preset is a file that stores the entire settings profile of the pipette, including Admin mode, with two exceptions.

- User Presets do not include a passcode. The passcode setting is always the last active setting.
- User and Mode Presets (see Mode Presets Option section) are stored separately on the on-board micro-SD card. Mode Presets are therefore not linked to any User Preset.

User Presets can be helpful tools for storing different configurations of the pipette settings for distinct tasks. Some tasks might require a more open configuration (e.g. R&D) while others require a very restricted and more controlled configuration (e.g. manufacturing processes). Saving each configuration as a User Preset allows the user to quickly re-configure the pipette for different purposes.



K: User Presets



L: Enter Presets



M: User Preset Screen#2

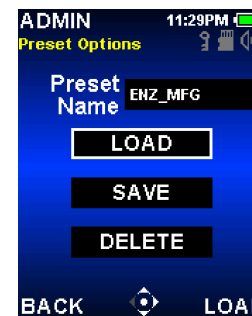

N: Preset Option Screen

User Preset Management

If you want to save a new User Preset or edit an existing one, make sure that the current pipette setting configuration is the one desired. ► or ● ENTER on the User Preset menu (Admin mode page 2, Figure B). On the User Presets screen you will see your list of saved Presets (Figure K).

To SAVE a new User Preset:

1. Use ▲ and ▼ to highlight "New" (Figure K).
2. SELECT to enter a filename. ◀▶, ▲ or ▼ to highlight characters, ● to select a character. ● @ at the bottom left of the screen to access more symbols (Figure L).
3. SAVE or CANCEL when needed. The pipette will return to the User Preset screen.
4. BACK to return to Admin mode.

To LOAD or DELETE an existing User Preset:

1. In the Preset Select screen, ▲ and ▼ to highlight a User Preset (Figure M).
2. SELECT to access Preset Options screen (Figure N). ▲ and ▼ to highlight LOAD or DELETE.
3. LOAD will immediately return pipette to the settings as they were when the Preset was saved.
4. DELETE will prompt a Delete Confirm warning message: DELETE to remove User Preset or CANCEL.

To edit an existing Mode Preset:

1. Use ▲ and ▼ to highlight the Preset you wish to edit on the User Preset screen (Figure M).
2. SELECT and then use ▲ and ▼ to highlight SAVE on the Preset Options screen (Figure N).
3. SAVE opens the Filename screen, with the selected Preset name indicated.
4. SAVE again, without changing the Preset name, to edit the existing Preset. Confirm SAVE.
5. Changing the Preset name in step (4) will save your edited Preset as a new Preset without changing the one you selected in (1).

Factory Default Settings Reset

This feature resets the pipette back to its factory default settings. All temporary settings, including the Admin passcode, are removed or reset, and the unit reverts to English. However, any Mode or User Presets are saved because they are stored on the micro-SD card.

1. ► or ● RESET on the Factory Default menu (Admin mode page 2, Figure B).
2. CONT to confirm reset.

1.11 Operational Modes

General information on editing settings and operation are described in “Basic Operation — Using Basic Mode” on page 7. Detailed settings and options descriptions can be found in “Options and Settings” on page 712. This section will provide mode-specific information and operating instructions for each of the E4 XLS operational modes.

Basic Mode



Basic Mode provides basic laboratory pipetting needs. Users can select a single volume and one speed that is used for both aspirate and dispense. The default menu level for Basic Mode is Level 1. To access Basic Mode, ◀ or ▶ in the Main Menu to highlight **BASIC** and ●, ▲ or ▼ to enter.

Options and Settings

- Options: None
- Settings: Single Volume, Single Speed
- Blowout: Automatic and manually repeatable

Advanced Mode



Advanced Mode provides the complete range of all E4 XLS advanced pipetting options. The default menu level for Advanced Mode is Level 1. To access Advanced Mode, ◀ or ▶ in the Main Menu to highlight **ADVANCED** and ●, ▲ or ▼ to enter.

Options and Settings

- Options: Fixed Volume, Volume Sequencing, Mix, Blowout, Cycle Counter, Mode Presets
- Settings: Single and Fixed Volume, Volume Sequencing, Multi-Speed, Mix, Cycle Count, Mode Presets
- Blowout: Automatic and manual

Options Selection

1. **OPTIONS** to enter the Options screen.
2. ▲ or ▼ to navigate between and highlight options. ▲ or ▼ at the first or last option on a page to navigate between pages.
3. ● or ► to turn option on or off.
4. **DONE** or ◀ to save and return to the operating screen.

Mode Preset Option

For details on Mode Presets (options screen 2) see **Mode Presets** (section 1.13).

Editing Settings

When editing settings, hold the joystick in place to quickly scroll through values.

1. **▶** to enter the Settings screen.
2. **▲** or **▼** to navigate between and highlight settings.

Single Volume Settings

Volume is displayed in the Volume Setting box.

1. **●** or **▶** to edit.
2. **◀** or **▶** for coarse adjustment and **▲** or **▼** for fine.
3. **DONE** or **●** to save. **CANCEL** to exit without saving changes.
4. **DONE** to exit Settings screen and return to operating screen.

Fixed Volume Settings

Fixed Vol is displayed in Volume Setting box. Option must be on for this setting to be shown. **●** or **▶** to view the volume table. The volume currently selected will be highlighted in the table.

| | | | |
|----|------|-----|-------|
| 1. | 6.0 | 8. | 80.0 |
| 2. | 10.0 | 9. | 100.0 |
| 3. | 20.0 | 10. | 120.0 |
| 4. | 30.0 | 11. | 140.0 |
| 5. | 40.0 | 12. | 160.0 |
| 6. | 50.0 | 13. | 180.0 |
| 7. | 60.0 | 14. | 200.0 |

1. To select a preset volume, use the joystick to highlight a volume. Only active table cells (white text) will be available in the operating screen. **DONE** to set and exit table.
2. To add or remove active cells in the table, use the joystick to highlight a cell that represents the last entry needed. **END VOL** to add cells up to or remove cells after the highlighted cell.
3. To edit a preset volume, use the joystick to highlight the volume, **●** to edit. Both active and inactive cells can be edited. **◀** or **▶** for coarse adjustment and **▲** or **▼** for fine. **DONE** or **●** to save. Repeat as needed for other volumes. **CANCEL** to exit without saving changes. **DONE** to exit table.

Note: If no other selection is made before exiting the table, the Volume Setting will be set to the last volume edited.

4. **DONE** to exit Settings screen and return to operating screen.

Volume Sequencing Settings

Vol X of X is displayed in Volume Setting box. Option must be on for this setting to be shown. **●** or **▶** to view the volume table.

| | | | |
|----|------|-----|-------|
| 1. | 4.0 | 9. | 10.0 |
| 2. | 10.0 | 10. | 20.0 |
| 3. | 20.0 | 11. | 2.0 |
| 4. | 25.0 | 12. | 22.0 |
| 5. | 30.0 | 13. | 100.0 |
| 6. | 10.0 | 14. | 100.0 |
| 7. | 12.8 | 15. | 100.0 |

1. To select a series of preset volumes, use the joystick to highlight the last volume for the series. Only active table cells (white text) will be available in the operating screen. **END VOL** to set. **DONE** to exit table.
2. To edit a preset volume, use the joystick to highlight the volume, **●** to edit. Both active and inactive cells can be edited. **◀** or **▶** for coarse adjustment and **▲** or **▼** for fine. **DONE** or **●** to save. Repeat as needed for other volumes. **CANCEL** to exit without saving changes. **DONE** to exit table.

Note: If an **END VOL** is not set before exiting the table, the **END VOL** last selected will be retained.

3. **DONE** to exit Settings screen and return to operating screen.

Speed Settings

1. ● or ► to view individual operation speeds.

Note: The mix operation speed is shown only when the Mix option is on.

2. ▲ or ▼ to highlight setting, ● or ► to edit.
3. ◀ or ▶ for coarse speed adjustment of 1, 5 or 10 and ▲ or ▼ for fine adjustment in single digits.
4. **DONE** or ● to save. **CANCEL** to exit without saving changes. **DONE** to exit table.
5. **DONE** to exit Settings screen and return to operating screen.

| Cycle Speeds | |
|--------------|----|
| Aspirate | 7 |
| Dispense | 10 |
| Mix | 5 |

Mix Settings

Option must be on for this setting to be shown. ● or ► to view mix settings. ▲ or ▼ to highlight setting.

1. To change volume, ● or ► to edit. ◀ or ▶ for coarse adjustment and ▲ or ▼ for fine. **DONE** or ● to save. **CANCEL** to exit without saving changes. **DONE** to exit table.
2. To change cycles, ● or ► to edit. ◀ or ▶ for coarse adjustment and ▲ or ▼ for fine up to 99 cycles. ▼ at 1 for Manual. **DONE** or ● to save. **CANCEL** to exit without saving changes. **DONE** to exit table.
3. **DONE** to exit Settings screen and return to operating screen.

| Mix Settings | |
|--------------|--------|
| Volume | 40.0ul |
| Cycles | 8 |

Cycle Count Settings

Option must be on for this setting to be shown.

1. ● or ► to edit.
2. **RESET** to zero counter. ◀ or ▶ for coarse adjustment and ▲ or ▼ for fine.
3. **DONE** or ● to save. **CANCEL** to exit without saving changes.
4. **DONE** to exit Settings screen and return to operating screen.

Operation

The active operation will be displayed in the upper left of the operating screen. When aspirating and dispensing, it is not necessary to hold the joystick in place, E4 XLS will automatically complete the operation. At any time during operation:

- **RESET** empties the tip and resets the pipette operation to **ASPIRATE**.
- **MAIN** displays the menu the mode was accessed from.
- **HELP** provides general information for the highlighted setting. Operating instructions can be found in the Help for the Volume Setting.

Single and Fixed Volume Operation with optional Mixing

1. Single Volume operation: skip to step 2. Fixed Volume operation: ◀ to select the next fixed volume in the table if needed.

2. ● or ▲ to aspirate.
3. ● or ▼ to dispense. Each dispense is followed by an automatic blowout if enabled. If the Mix option is on:
 - When a set number of cycles is selected, mixing will execute automatically after each dispense followed by an automatic blowout if enabled. Select **PAUSE** at any time to pause mixing, then **RESUME** to continue.
 - If Manual is selected, continue to hold ▼ after dispense to execute mix cycle(s). Mixing will continue until the joystick is released. Mixing is followed by an automatic blowout if enabled.
4. ▼ or **RESET** for manual blowout(s) if needed.

Volume Sequencing Operation with optional Mixing

1. ◀ to select the next preset series volume in the table if needed.
2. ● or ▲ to aspirate.
3. ● or ▼ to dispense. Each dispense is followed by an automatic blowout if enabled. The series number in the Volume Setting box will increment after each dispense. If the Mix option is on:
 - When a set number of cycles is selected, mixing will execute automatically after each dispense followed by an automatic blowout if enabled. Select **PAUSE** at any time to pause mixing, then **RESUME** to continue.
 - If Manual is selected, continue to hold ▼ after dispense to execute mix cycle(s). Mixing will continue until the joystick is released. Mixing is followed by an automatic blowout if enabled.
4. ▼ or **RESET** for manual blowout(s) if needed.
5. Repeat the steps above until the series is complete.

Multi-Dispense Mode



Multi-Dispense Mode provides multi-aliquot dispensing with user-settable automatic dispense intervals. The default menu level for Multi-Dispense Mode is Level I. To access Multi-Dispense Mode, ◀ or ▶ in the Main Menu to highlight **MULTI-DISP** and ●, ▲ or ▼ to enter. Note that the pipette aspirates an extra volume of liquid (residual liquid) that is left over after dispensing all aliquots. This is to ensure accurate delivery of all aliquots.

Options and Settings

- Options: Fixed Aliquot Volumes, Mode Presets, Volume Sequencing, Auto Pace
- Settings: Single and Fixed Volume (with Number of Aliquots and Aliquot Volume), Volume Sequencing, Multi-Speed, Mode Presets
- Blowout: Joystick blowout optional: can be turned off

Options Selection

1. **OPTIONS** to enter the Options screen.
2. ▲ or ▼ to navigate between and highlight options.

Fixed Volume, Volume Sequencing, and Blowout Options

- or ▶ to turn option on or off.
1. **DONE** or ◀ to save and return to the operating screen.

Blowout Option

ON (default condition) means that blowout with the joystick is enabled after dispensing the last aliquot. OFF means that joystick blowout is disabled – the softkey must be used instead. OFF may be helpful for users concerned with inadvertently dispensing the residual (non-aliquot) liquid.

Auto Pace Option

1. ● or ► to edit.
2. Intervals from 0.1 to 30 seconds can be set. ◀ or ► for coarse adjustment and ▲ or ▼ for fine. ◀ at 2.0 or ▼ at 0.1 for Off.
3. **DONE** or ● to save. **CANCEL** to exit without saving changes.
4. **DONE** to return to the operating screen.

Mode Preset Option

For details on Mode Presets (options screen 2) see **Mode Presets (section 1.13)**.

Editing Settings

When editing settings, hold the joystick in place to quickly scroll through values.

1. ► to enter the Settings screen.
2. ▲ or ▼ to navigate between and highlight settings.

Single Volume — Dispensing Based on Number of Aliquots

1. Highlight the Aliquots Setting box (**Aliquots**). ● or ► to edit. ◀ or ► for coarse adjustment and ▲ or ▼ for fine. **DONE** or ● to save. **CANCEL** to exit without saving changes.

Note: E4 XLS will only allow values in the Aliquots Setting that will not exceed the maximum pipette volume with the current Aliquot Volume Setting. If the desired value cannot be selected, change the Aliquot Volume Setting to a lower value. The Volume Setting will automatically adjust based on the new Aliquots Setting and the existing Aliquot Volume Setting.

2. If needed, set the aliquot volume by highlighting the Aliquot Volume Setting box (**Aliquot Vol**). ● or ► to edit. ◀ or ► for coarse adjustment and ▲ or ▼ for fine. **DONE** or ● to save. **CANCEL** to exit without saving changes.

Note: E4 XLS will only allow values in the Aliquot Volume Setting that will not exceed the maximum pipette volume with the current Aliquots Setting. The Volume Setting will automatically adjust based on the new Aliquot Volume Setting and the existing Aliquots Setting.

3. **DONE** to exit Settings screen and return to operating screen.

Single Volume — Dispensing Based on Aliquot Volume

1. Highlight the Aliquot Volume Setting box (**Aliquot Vol**). ● or ► to edit. ◀ or ► for coarse adjustment and ▲ or ▼ for fine. **DONE** or ● to save. **CANCEL** to exit without saving changes.

Note: E4 XLS will only allow values in the Aliquot Volume Setting that will not exceed the maximum pipette volume with the current Aliquots Setting. If the desired value cannot be selected, change the Aliquots Setting to a lower value. The Volume Setting will automatically adjust based on the new Aliquot Volume Setting and the existing Aliquots Setting.

- If needed, set the number of aliquots by highlighting the Aliquots Setting box (**Aliquots**). ● or ► to edit. ◀ or ► for coarse adjustment and ▲ or ▼ for fine. **DONE** or ● to save. **CANCEL** to exit without saving changes.

Note: E4 XLS will only allow values in the Aliquots Setting that will not exceed the maximum pipette volume with the current Aliquot Volume Setting. The Volume Setting will automatically adjust based on the new Aliquots Setting and the existing Aliquot Volume Setting.

- DONE** to exit Settings screen and return to operating screen.

Fixed Aliquot Volume Settings

Fixed Aliquot Vol is displayed in Volume Setting box. Option must be on for this setting to be shown. ● or ► to view the volume table. The volume currently selected will be highlighted in the table.

- To select a preset volume, use the joystick to highlight a volume. Only active table cells (white text) will be available in the operating screen. **DONE** to set and exit table.
- To add or remove active cells in the table, use the joystick to highlight a cell that represents the last entry needed. **END VOL** to add cells up to or remove cells after the highlighted cell.
- To edit a preset aliquot volume, use the joystick to highlight the volume, ● to edit. Both active and inactive cells can be edited. ◀ or ► for coarse adjustment and ▲ or ▼ for fine. **DONE** or ● to save. Repeat as needed for other aliquot volumes. **CANCEL** to exit without saving changes. **DONE** to exit table.

Note: If no other selection is made before exiting the table, the Volume Setting will be set to the last aliquot volume edited.

- DONE** to exit Settings screen and return to operating screen.

Volume Sequencing

Option must be on for these settings to be shown. The first setting, Volume Information (**Vol X of X**), displays the total aspirate volume required to dispense the full or partial set of aliquots in the series. If only one aspiration is required to dispense the full series, **Vol 1 of 1** is shown. If the series volume exceeds the pipette maximum volume, it is split into multiple aspirations and **Vol 1 of X** is shown: e.g., if two aspirations are required, **Vol 1 of 2** is shown at the initial **ASPIRATE** operation. This will increment to **Vol 2 of 2** when the next volume must be aspirated.

- To select a series of preset volumes, highlight the Aliquots Setting (**Alq X of X**). ● or ► to view the volume table. Use the joystick to highlight the last volume for the series. Only active table cells (white text) can be selected. **END VOL** to set. **DONE** to exit table.
- To edit a preset volume, use the joystick to highlight the volume, ● to edit. Both active and inactive cells can be edited. ◀ or ► for coarse adjustment and ▲ or ▼ for fine. **DONE** or ● to save. Repeat as needed for other volumes. **CANCEL** to exit without saving changes. **DONE** to exit table.

Note: If an **END VOL** is not set before exiting the table, the **END VOL** last selected will be retained.

- DONE** to exit Settings screen and return to operating screen.

Speed Settings

- or ► to view individual operation speeds.
- ▲ or ▼ to highlight setting, ● or ► to edit.
- ◀ or ► for coarse speed adjustment of 1, 5 or 10 and ▲ or ▼ for fine adjustment in single digits.
- DONE** or ● to save. **CANCEL** to exit without saving changes. **DONE** to exit table.



5. **DONE** to exit Settings screen and return to operating screen.

Operation

The active operation will be displayed in the upper left of the operating screen. When aspirating and dispensing, it is not necessary to hold the joystick in place, E4 XLS will automatically complete the operation. At any time during operation:

- **RESET** empties the tip and resets the pipette operation to **ASPIRATE**.
- **MAIN** displays the menu the mode was accessed from.
- **HELP** provides general information for the highlighted setting. Operating instructions can be found in the Help for the Volume Setting.

Single or Fixed Aliquot Volume Operation

1. ● or ▲ to aspirate.
2. ● or ▼ to dispense into the first receiving vessel:
 - If the Auto Pace option is off, place the tip into the next receiving vessel. ▼ again to dispense. Repeat this step for each of the remaining aliquots. The series number in the Aliquot Setting will increment after each dispense.
 - If the Auto Pace option is on, **DISPENSE AUTO** will display. Place the tip into the next receiving vessel. An interval counter will display at the top of the operating screen. The aliquot will dispense automatically when the set interval is reached. Repeat this step for each of the remaining aliquots. The series number in the Aliquot Setting will increment after each dispense.
3. When aliquot dispensing is complete, **BLOWOUT** will display. ▲ to re-aspirate and repeat dispensing step, ▼, **BLOWOUT** or **RESET** to execute blowout. ▼, **BLOWOUT** or **RESET** again if more blowout(s) needed. ▼ will only work if Blowout option is on.
4. ◀ to select the next fixed preset aliquot volume in the table if needed.

Volume Sequencing Operation

1. ◀ to select the next preset series volume in the table if needed.
2. ● or ▲ to aspirate.
3. ● or ▼ to dispense into the first receiving vessel:
 - If the Auto Pace option is off, place the tip into the next receiving vessel. ▼ again to dispense. Repeat this step for each of the remaining aliquots. The Aliquot Setting box will display the volume for each aliquot in the series, and the series volume number will increment after each dispense.
 - If the Auto Pace option is on, **DISPENSE AUTO** will display. Place the tip into the next receiving vessel. An interval counter will be shown at the top of the operating screen. The aliquot will dispense automatically when the interval is reached. Repeat this step for each of the remaining aliquots. The Aliquot Setting box will display the volume for each aliquot in the series, and the series volume number will increment after each dispense.
4. If more than one aspirate volume is required to dispense the full series, the series number in the Volume Information Setting will increment and **ASPIRATE** will display. ▲ to aspirate the next volume and repeat dispensing. ▼ or ● will blowout (if Blowout option is ON. Blowout between aspiration steps is optional.

If Blowout option is OFF, use **BLOWOUT** softkey. Pressing **RESET** will move the piston through blowout and reset back to the beginning of the sequence.

5. Repeat the steps above until the series is complete.
6. When aliquot dispensing is complete, ▲ to re-aspirate and begin sequence again, or blowout the residual liquid.

Manual Mode



Manual Mode provides joystick control of E4 XLS that simulates manual pipette operation. Additionally, fine control of precise volume increments allows aspiration and dispense of measured sample volumes. The default menu level for Manual Mode is Level I. To access Manual Mode, ◀ or ▶ in the Main Menu to highlight **MANUAL** and ●, ▲ or ▼ to enter.

Options and Settings

- Options: Fixed Volume, Cycle Counter, Mode Presets
- Settings: Single and Fixed Volume, Single Speed, Cycle Count, Mode Presets
- Blowout: Manual

Options Selection

1. **OPTIONS** to enter the Options screen.
2. ▲ or ▼ to navigate between and highlight options.
3. ● or ▶ to turn option on or off.
4. **DONE** or ◀ to save and return to the operating screen.

Mode Preset Option

For details on Mode Presets (options screen 1) see **Mode Presets** (section 1.13).

Editing Settings

When editing settings, hold the joystick in place to quickly scroll through values.

1. ▶ to enter the Settings screen.
2. ▲ or ▼ to navigate between and highlight settings.

Single Volume Settings

Volume is displayed in Volume Setting box. This value represents the maximum aspiration volume required for the desired measurement.

1. ● or ▶ to edit.
2. ◀ or ▶ for coarse adjustment and ▲ or ▼ for fine.
3. **DONE** or ● to save. **CANCEL** to exit without saving changes.
4. **DONE** to exit Settings screen and return to operating screen.

Fixed Volume Settings

Fixed Vol X is displayed in Volume Setting box. Option must be on for this setting to be shown. This value represents the maximum aspiration volume required for the desired measurement. ● or ► to view the volume table. The volume currently selected will be highlighted in the table.

1. To select a preset volume, use the joystick to highlight a volume. Only active table cells (white text) will be available in the operating screen. **DONE** to set and exit table.
2. To add or remove active cells in the table, use the joystick to highlight a cell that represents the last entry needed. **END VOL** to add cells up to or remove cells after the highlighted cell.
3. To edit a preset volume, use the joystick to highlight the volume, ● to edit. Both active and inactive cells can be edited. ◀ or ▶ for coarse adjustment and ▲ or ▼ for fine. **DONE** or ● to save. Repeat as needed for other volumes. **CANCEL** to exit without saving changes. **DONE** to exit table.

Note: If no other selection is made before exiting the table, the Volume Setting will be set to the last volume edited.

4. **DONE** to exit Settings screen and return to operating screen.

Speed Settings

1. ● or ► to edit.
2. ◀ or ▶ for coarse speed adjustment of 1, 5 or 10 and ▲ or ▼ for fine adjustment in single digits.
3. **DONE** or ● to save. **CANCEL** to exit without saving changes.
4. **DONE** to exit Settings screen and return to operating screen.

Cycle Count Settings

Option must be on for this setting to be shown.

1. ● or ► to edit.
2. **RESET** to zero counter. ◀ or ▶ for coarse adjustment and ▲ or ▼ for fine.
3. **DONE** or ● to save. **CANCEL** to exit without saving changes.
4. **DONE** to exit Settings screen and return to operating screen.

Operation

The active operation will be displayed in the upper left of the operating screen. At any time during operation:

- **RESET** empties the tip and resets the pipette operation to **ASPIRATE**.
- **MAIN** displays the menu the mode was accessed from.
- **HELP** provides general information for the highlighted setting. Operating instructions can be found in the Help for the Volume Setting.

Single and Fixed Volume Operation

1. Single Volume operation: skip to step 2. Fixed Volume operation: ◀ to select the next fixed volume in the table if needed.

2. ▲ and hold to aspirate, then ▼ and hold to dispense at any time. It is not necessary to aspirate the full amount in the Volume Setting before beginning dispense. The amount of sample aspirated or dispense is controlled directly through the joystick:
 - As the joystick is moved towards its maximum position, larger volumes will aspirate/dispense at a faster rate. To aspirate/dispense smaller volumes at slower rates, move the joystick slowly until the desired rate is achieved.
 - If the joystick is released operation will pause. When joystick control resumes, operation will continue from the same point.
 - **STEP** will aspirate/dispense the pipette's minimum allowable increment each time the soft key is pressed. **STEP** can be held down and continuously activated.
 - If the value set in the Volume Setting is reached, aspiration control will halt.
3. When dispense is complete, ▼ or **RESET** for manual blowout(s) if needed.

Volume Measurement (Single or Fixed Volume Operation)

1. Single Volume operation: skip to step 2. Fixed Volume operation: ◀ to select the next fixed volume in the table if needed.
2. ▲ to aspirate the unknown volume of sample into the tip:
 - The amount of sample drawn into the tip is controlled directly through the joystick. As the joystick is moved towards its maximum upward position, larger volumes will be aspirated at a faster rate. To aspirate smaller volumes at slower rates, move the joystick slowly until the desired rate is achieved.
 - If the joystick is released, operation will pause. When joystick control resumes, operation will continue from the same point.
 - **STEP** will aspirate the pipette's minimum allowable increment each time the soft key is pressed.
3. If needed, ▼ slowly to release unwanted air from the tip.
4. If the value set in the Volume Setting is reached, aspiration control will halt. ▼ slowly to release sample or air from the tip, or **STEP** to release a minimum increment.
5. Repeat the steps above as necessary until the liquid in the tip is level with the tip orifice. The in-tip sample volume is displayed in the lower left of the operating screen and represents the measured volume.
6. ▼ and hold or **RESET** to release sample from the tip.
7. ▼ or **RESET** for manual blowout(s) if needed.

1.12 Level II Menu

The Level II Menu provides access to more advanced modes as well as Service mode, where users can view service information and set service alarms. The default Level II operational mode selections include Reverse Mode, Dilute Mode, Titrate Mode, Admin Mode and (if available) PureSpeed Mode.

To access the Level II Menu, ◀ or ▶ in the Level I Menu to highlight **LEVEL II** and ●, ▲ or ▼ to enter.

Level II Menu Navigation

- ◀ or ▶ to view and select menu items
- ●, ▲ or ▼ to enter the selected menu item
- Select **LEVEL 1** to return to the Level I Menu
- **PREV** to return to the previously viewed screen
- **HELP** for a detailed description of the highlighted menu item
- **SETUP** when Level I is highlighted to go directly to Setup Mode and change pipette settings

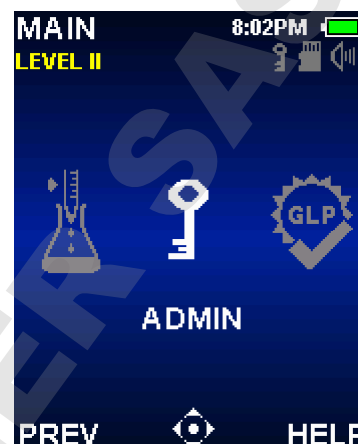

Figure 22: Level II Menu

Reverse Mode



Reverse Mode is an established pipetting technique that enables users to aspirate the selected volume along with the pipette blowout volume, and is recommended for dense or volatile liquids. The default menu level for Reverse Mode is Level II. To access Reverse Mode, ◀ or ▶ in the Level II Menu to highlight **REVERSE**, and ●, ▲ or ▼ to enter.

Options and Settings

- Options: Fixed Volume, Volume Sequencing, Blowout, Cycle Counter, Mode Presets
- Settings: Single and Fixed Volume, Volume Sequencing, Multi-Speed, Cycle Count
- Blowout: Manual

Options Selection

1. **OPTIONS** to enter the Options screen.
2. ▲ or ▼ to navigate between and highlight options.
3. ● or ▶ to turn option on or off.
4. **DONE** or ◀ to save and return to the operating screen.

Blowout Option

Blowout ON in Reverse Mode means that a manual blowout is required before next aspiration. ▼ or **RESET** to Blowout. Blowout OFF means that re-aspiration can occur without a blowout.

Mode Preset Option

For details on Mode Presets (options screen 2) see **Mode Presets** (section 1.13).

Editing Settings

When editing settings, hold the joystick in place to quickly scroll through values.

- ▶ to enter the Settings screen.
- ▲ or ▼ to navigate between and highlight settings.

Single Volume Setting

Volume is displayed in Volume Setting box.

- or ▶ to edit.
- ◀ or ▶ for coarse adjustment and ▲ or ▼ for fine.
- DONE** or ● to save. **CANCEL** to exit without saving changes.
- DONE** to exit Settings screen and return to operating screen.

Fixed Volume Settings

Fixed Vol X is displayed in Volume Setting box. Option must be on for this setting to be shown. ● or ▶ to view the volume table. The volume currently selected will be highlighted in the table.

- To select a preset volume, use the joystick to highlight a volume. Only active table cells (white text) will be available in the operating screen. **DONE** to set and exit table.
- To add or remove active cells in the table, use the joystick to highlight a cell that represents the last entry needed. **END VOL** to add cells up to or remove cells after the highlighted cell.
- To edit a preset volume, use the joystick to highlight the volume, ● to edit. Both active and inactive cells can be edited. ◀ or ▶ for coarse adjustment and ▲ or ▼ for fine. **DONE** or ● to save. Repeat as needed for other volumes. **CANCEL** to exit without saving changes. **DONE** to exit table.

Note: If no other selection is made before exiting the table, the Volume Setting will be set to the last volume edited.

- DONE** to exit Settings screen and return to operating screen.

Volume Sequencing Settings

Vol X of X is displayed in Volume Setting box. Option must be on for this setting to be shown. ● or ▶ to view the volume table.

- To select a series of preset volumes, use the joystick to highlight the last volume for the series. Only active table cells (white text) will be available in the operating screen. **END VOL** to set. **DONE** to exit table.

| | | | |
|----|------|-----|-------|
| 1. | 6.0 | 8. | 80.0 |
| 2. | 10.0 | 9. | 100.0 |
| 3. | 20.0 | 10. | 120.0 |
| 4. | 30.0 | 11. | 140.0 |
| 5. | 40.0 | 12. | 160.0 |
| 6. | 50.0 | 13. | 180.0 |
| 7. | 60.0 | 14. | 200.0 |

| | | | |
|----|------|-----|-------|
| 1. | 4.0 | 9. | 10.0 |
| 2. | 10.0 | 10. | 20.0 |
| 3. | 20.0 | 11. | 2.0 |
| 4. | 25.0 | 12. | 22.0 |
| 5. | 30.0 | 13. | 100.0 |
| 6. | 10.0 | 14. | 100.0 |
| 7. | 12.8 | 15. | 100.0 |

- To edit a preset volume, use the joystick to highlight the volume, ● to edit. Both active and inactive cells can be edited. ◀ or ▶ for coarse adjustment and ▲ or ▼ for fine. **DONE** or ● to save. Repeat as needed for other volumes. **CANCEL** to exit without saving changes. **DONE** to exit table.

Note: If an **END VOL** is not set before exiting the table, the **END VOL** last selected will be retained.

- DONE** to exit Settings screen and return to operating screen.

Speed Settings

- or ▶ to view individual operation speeds.
- ▲ or ▼ to highlight setting, ● or ▶ to edit.
- ◀ or ▶ for coarse speed adjustment of 1, 5 or 10 and ▲ or ▼ for fine adjustment in single digits.
- DONE** or ● to save. **CANCEL** to exit without saving changes. **DONE** to exit table.
- DONE** to exit Settings screen and return to operating screen.

Cycle Speeds

| | |
|----------|----|
| Aspirate | 7 |
| Dispense | 10 |

Cycle Count Settings

Option must be on for this setting to be shown.

- or ▶ to edit.
- RESET** to zero counter. ◀ or ▶ for coarse adjustment and ▲ or ▼ for fine.
- DONE** or ● to save. **CANCEL** to exit without saving changes.
- DONE** to exit Settings screen and return to operating screen.

Operation

The active operation will be displayed in the upper left of the operating screen. When aspirating and dispensing, it is not necessary to hold the joystick in place, E4 XLS will automatically complete the operation. At any time during operation:

- **RESET** empties the tip and resets the pipette operation to **ASPIRATE**.
- **MAIN** displays the menu the mode was accessed from.
- **HELP** provides general information for the highlighted setting. Operating instructions can be found in the Help for the Volume Setting.

Single and Fixed Volume Operation

- Single Volume operation: skip to step 2. Fixed Volume operation: ◀ to select the next fixed volume in the table if needed.
- or ▲ to aspirate selected volume plus blowout volume.
- or ▼ to dispense. If blowout is enabled, **BLOWOUT** will display in the operating screen. ▼ to execute blowout.
- ▼ or **RESET** for manual blowout(s) if needed.

Volume Sequencing Operation

- ◀ to select the next preset series volume in the table if needed.

2. ● or ▲ to aspirate the preset volume plus blowout volume.
3. ● or ▼ to dispense. The series number in the Volume Setting box will increment after each dispense. If blowout is enabled, **BLOWOUT** will display in the operating screen. ▼ to execute blowout.
4. ▼ or **RESET** for manual blowout(s) if needed.
5. Repeat steps above until the series is complete.

Dilute Mode



Dilute Mode provides in-tip dilution of multiple sample volumes. Operation using the Single Volume setting allows aspiration of two volumes separated by an air gap. Operation using the Volume Sequencing option allows multiple volumes to be aspirated into the tip prior to dispense. The default menu level for Dilute Mode is Level II. To access Dilute Mode, ◀ or ▶ in the Level II Menu to highlight **DILUTE** and ●, ▲ or ▼ to enter.

Options and Settings

- Options: Volume Sequencing, Mix, Blowout, Cycle Counter, Mode Presets
- Settings: Single Volume, Volume Sequencing, Multi-Speed, Mix, Cycle Count, Mode Preset
- Blowout: Automatic and manual

Options Selection

1. **OPTIONS** to enter the Options screen.
2. ▲ or ▼ to navigate between and highlight options.
3. ● or ▶ to turn option on or off.
4. **DONE** or ◀ to save and return to the operating screen.

Mode Preset Option

For details on Mode Presets (options screen 2) see **Mode Presets (section 1.13)**.

Editing Settings

When editing settings, hold the joystick in place to quickly scroll through values.

1. ▶ to enter the Settings screen.
2. ▲ or ▼ to navigate between and highlight settings.

Single Volume Settings

Volume X is displayed in Volume Setting box. The Single Volume setting allows two dilution volumes to be set for aspiration. During operation, Asp 1 will be aspirated first, followed by an air gap, then Asp 2.

Note: Rainin recommends using Asp 1 for diluent and Asp 2 for sample.

1. ● or ▶ to view Dilute Volumes. ▲ or ▼ to highlight setting.
2. ● or ▶ to edit.
3. ◀ or ▶ for coarse adjustment and ▲ or ▼ for fine.

| Dilute Volumes | |
|----------------|------|
| Asp #1 | 80.0 |
| Asp #2 | 20.0 |

Note: Selectable Asp 2 values will automatically adjust to only allow values that will not exceed the pipette maximum once the Asp 1 volume is aspirated.

4. **DONE** or ● to save. **CANCEL** to exit without saving changes. **DONE** to exit table.
5. **DONE** to exit Settings screen and return to operating screen.

Volume Sequencing Settings

Vol X of X is displayed in Volume Setting box. Option must be on for this setting to be shown. During operation, each volume selected will be aspirated in series. ● or ► to view the volume.

1. To select a series of preset volumes, use the joystick to highlight the last volume for the series. Only active table cells (white text) can be selected. **END VOL** to set. **DONE** to exit table.

Note: E4 XLS will not allow selection of an **END VOL** that will cause the total series volume to exceed the pipette maximum. If this occurs, edit the desired **END VOL** value until the total series volume is less than the pipette max volume.

2. To edit a preset volume, use the joystick to highlight the volume, ● to edit. Both active and inactive cells can be edited. ◀ or ► for coarse adjustment and ▲ or ▼ for fine. **DONE** or ● to save. Repeat as needed for other volumes. **CANCEL** to exit without saving changes. **DONE** to exit table.

Note: Preset volumes can be used for samples, diluents and air gaps. If an **END VOL** is not set before exiting the table, the **END VOL** last selected will be retained.

3. **DONE** to exit Settings screen and return to operating screen.

| Seq Volumes ul | | |
|----------------|------|-----------|
| 1. | 4.0 | 9. 10.0 |
| 2. | 10.0 | 10. 20.0 |
| 3. | 20.0 | 11. 2.0 |
| 4. | 25.0 | 12. 22.0 |
| 5. | 30.0 | 13. 100.0 |
| 6. | 10.0 | 14. 100.0 |
| 7. | 12.8 | 15. 100.0 |

Speed Settings

1. ● or ► to view individual operation speeds.

Note: The mix operation speed is shown only when the Mix option is on.

2. ▲ or ▼ to highlight setting, ● or ► to edit.
3. ◀ or ► for coarse speed adjustment of 1, 5 or 10 and ▲ or ▼ for fine adjustment in single digits.
4. **DONE** or ● to save. **CANCEL** to exit without saving changes. **DONE** to exit table.
5. **DONE** to exit Settings screen and return to operating screen.

| Cycle Speeds | |
|--------------|----|
| Aspirate | 7 |
| Dispense | 10 |
| Mix | 5 |

Mix Settings

Option must be on for this setting to be shown. ● or ► to view mix settings. ▲ or ▼ to highlight setting.

1. To change volume, ● or ► to edit. ◀ or ► for coarse adjustment and ▲ or ▼ for fine. **DONE** or ● to save. **DONE** to exit table.
2. To change cycles, ● or ► to edit. ◀ or ► for coarse adjustment and ▲ or ▼ for fine up to 99 cycles. ▼ at 1 for Manual. **DONE** or ● to save. **CANCEL** to exit without saving changes. **DONE** to exit table.
3. **DONE** to exit Settings screen and return to operating screen.

| Mix Settings | |
|--------------|--------|
| Volume | 40.0ul |
| Cycles | 8 |

Cycle Count Settings

Option must be on for this setting to be shown.

1. ● or ► to edit.
2. **RESET** to zero counter. ◀ or ▶ for coarse adjustment and ▲ or ▼ for fine.
3. **DONE** or ● to save. **CANCEL** to exit without saving changes.
4. **DONE** to exit Settings screen and return to operating screen.

Operation

The active operation will be displayed in the upper left of the operating screen. When aspirating and dispensing, it is not necessary to hold the joystick in place, E4 XLS will automatically complete the operation. At any time during operation:

- **RESET** empties the tip and resets the pipette operation to **ASPIRATE**.
- **MAIN** displays the menu the mode was accessed from.
- **HELP** provides general information for the highlighted setting. Operating instructions can be found in the Help for the Volume Setting.

Single Volume Operation with optional mixing

1. **Volume 1** will display in the Volume Setting box. ● or ▲ to aspirate diluent.
2. Remove the pipette tip from the diluent. **AIR** will display in the Volume Setting box. ● or ▲ to aspirate an air gap.
3. Place the pipette tip in the next sample. **Volume 2** will display in the Volume Setting box. ● or ▲ to aspirate.
4. ● or ▼ to dispense. Each dispense is followed by an automatic blowout if enabled. If the Mix option is on:
 - When a set number of cycles is selected, mixing will execute automatically after each dispense followed by an automatic blowout if enabled. Select **PAUSE** at any time to pause mixing, then **RESUME** to continue.
 - If Manual is selected, continue to hold ▼ after dispense to execute mix cycle(s). Mixing will continue until the joystick is released. Mixing is followed by an automatic blowout if enabled.
5. ▼ or **RESET** for manual blowout(s) if needed.

Volume Sequencing Operation with optional mixing

1. **Vol 1 of X** will display in the Volume Setting box. ◀ to select the next preset series volume in the table if needed. Place the pipette tip in the first sample. ● or ▲ to aspirate.
2. **Vol 2 of X** will display in the Volume Setting box. Place the pipette tip in the next sample or diluent, or remove the tip completely from liquid for an air gap. ● or ▲ to aspirate.
3. Repeat Step 2 until all samples in the series are aspirated. The series number in the Volume Setting box will increment after each aspiration.
4. ● or ▼ to dispense. Each dispense is followed by an automatic blowout if enabled. If the Mix option is on:
 - When a set number of cycles is selected, mixing will execute automatically after each dispense followed by an automatic blowout if enabled. Select **PAUSE** at any time to pause mixing, then **RESUME** to continue.

- If Manual is selected, continue to hold ▼ after dispense to execute mix cycle(s). Mixing will continue until the joystick is released. Mixing is followed by an automatic blowout if enabled.

5. ▼ or **RESET** for manual blowout(s) if needed.

Titrate Mode



Titrate Mode performs titration through measured dispensing. Users can set an initial rapid dispense and then precisely control dispense of the remaining titration volume. The default menu level for Titrate Mode is Level II. To access Titrate Mode, ◀ or ▶ in the Level II Menu to highlight **TITRATE** and ●, ▲ or ▼ to enter.

Options and Settings

- Options: Cycle Counter, Mode Presets
- Settings: Single Volume (with Fast Dispense), Multi-Speed, Cycle Count, Mode Presets
- Blowout: Manual

Options Selection

1. **OPTIONS** to enter the Options screen.
2. ● or ▶ to turn option on or off.
1. **DONE** or ◀ to save and return to the operating screen.

Mode Preset Option

For details on Mode Presets (options screen 1) see **Mode Presets (section 1.13)**.

Editing Settings

When editing settings, hold the joystick in place to quickly scroll through values.

1. ▶ to enter the Settings screen.
2. ▲ or ▼ to navigate between and highlight settings.

Single Volume Settings

Asp Vol is displayed in Volume Setting box. This value represents the maximum aspiration volume required for the titration.

1. ● or ▶ to edit.
2. ◀ or ▶ for coarse adjustment and ▲ or ▼ for fine.
3. **DONE** or ● to save. **CANCEL** to exit without saving changes.
4. **DONE** to exit Settings screen and return to operating screen.

Fast Dispense Volume Settings

The Fast Dispense Setting (**Fast Dsp Vol**) represents the first initial volume of sample to dispense prior to starting the fine dispense control for the titration.

Note: If this value is set to 0.0 μL , the fine dispense control will begin immediately after aspiration.

1. ● or ► to edit.
2. ◀ or ► for coarse adjustment and ▲ or ▼ for fine.
3. **DONE** or ● to save. **CANCEL** to exit without saving changes.
4. **DONE** to exit Settings screen and return to operating screen.

Speed Settings

1. ● or ► to view individual operation speeds.
2. ▲ or ▼ to highlight setting, ● or ► to edit.
3. ◀ or ► for coarse speed adjustment of 1, 5 or 10 and ▲ or ▼ for fine adjustment in single digits.
4. **DONE** or ● to save. **CANCEL** to exit without saving changes. **DONE** to exit table.
5. **DONE** to exit Settings screen and return to operating screen.

| Cycle Speeds | |
|--------------|----|
| Aspirate | 7 |
| Dispense | 10 |

Cycle Count Settings

Option must be on for this setting to be shown.

1. ● or ► to edit.
2. **RESET** to zero counter. ◀ or ► for coarse adjustment and ▲ or ▼ for fine.
3. **DONE** or ● to save. **CANCEL** to exit without saving changes.
4. **DONE** to exit Settings screen and return to operating screen.

Operation

The active operation will be displayed in the upper left of the operating screen. When aspirating or performing a Fast Dispense, it is not necessary to hold the joystick in place, E4 XLS will automatically complete the operation. At any time during operation:

- **RESET** empties the tip and resets the pipette operation to **ASPIRATE**.
- **MAIN** displays the menu the mode was accessed from.
- **HELP** provides general information for the highlighted setting. Operating instructions can be found in the Help for the Volume Setting.

1. ● or ▲ to aspirate.
2. If a value was set in the Fast Dispense Setting, **FAST DISPENSE** will display. ● or ▼ to dispense. If this value was set to zero, skip to the next step.
3. **TITRATE** will display and the Fast Dispense Setting box will now show **Dsp Total**. ▼ slowly to begin titrating the remaining volume:
 - As the joystick is moved towards its maximum downward position, larger volumes will be titrated at a faster rate. To titrate smaller volumes at slower rates, move the joystick slowly until the desired rate is achieved.

- If the joystick is released, operation will pause. When joystick control resumes, operation will continue from the same point.
 - **STEP** will dispense the pipette's minimum allowable increment each time the soft key is pressed.
 - During the titration, the **Dsp Total** value will automatically update with the total volume dispensed, including the Fast Dispense volume.
4. When the titration is complete, the value in the **Dsp Total** represents the total titration volume. The volume displayed in the lower left of the operating screen is the volume of sample that remains in the tip.
 5. ▼ and hold or **RESET** to release the remaining sample from the tip.
 6. ▼ or **RESET** for manual blowout(s) if needed.

1.13 Mode Presets

Mode Preset option allows for saving the entire mode setting to a Preset file on the micro-SD card. Use this option to save and rapidly recall favorite protocols.

Mode Presets require the presence of a micro-SD card and firmware version 1.4 or higher (included in all E4s with Serial numbers C14 and higher). See "Micro-SD Card Management and Firmware Upgrades" section for more details on how to upgrade older models.

Mode Presets are an Option available in all operational Modes except Basic.

Mode Preset Rapid Selection

Once your Presets are saved (see section below), it is easy to quickly load them and switch from one to another, directly from the Settings screen. There is no need to use the OPTIONS screen.

1. ▶ to enter the Settings screen (A>B). ▲ and ▼ to highlight Preset Selector. Note: If no Presets have been saved, the Preset Selector will not show up.
2. ▶ or ● Preset Selector to edit (C).
3. ◀▶, ▲ or ▼ to scroll through available Mode Presets (D>E). The Settings and Options for each Preset will be displayed.
4. ● or DONE to select a Preset, then ◀ or DONE to exit Settings. Selected Preset is now loaded (F) and ready to use.



A: Operation Screen

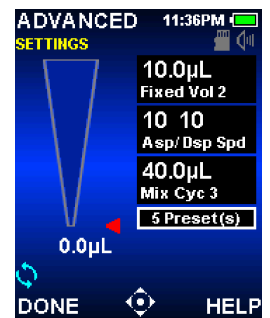

B: Preset Selector Highlighted



C: Preset Selector in Edit Mode



D: Mode Preset Option

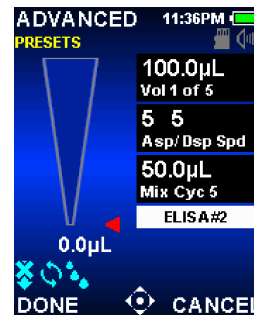

E: Mode Preset Option



F: Preset Loaded

Mode Preset Management

- If you want to save or edit a Mode Preset, make sure that the current Mode setting configuration is the one desired (A).
- Select **OPTIONS** and ▲ or ▼ to highlight Mode Preset Options (B)
- ▶ or ● **SELECT** to save, edit delete or load a Mode Preset
- On the preset select screen you will see your list of saved Mode Presets (C).
- To **SAVE** the current Mode Setting as a New Mode Preset:
 - Use ▲ and ▼ to highlight "New".
 - SELECT** to enter a filename (D). ◀▶, ▲ or ▼ to highlight characters, ● to select a character
 - SAVE** or **CANCEL** when needed. The E4 will return to the Preset Select Screen
 - BACK** to return to **OPTIONS**. **DONE** to return to operating screen.
- To **LOAD** or **DELETE** an existing Mode Preset:
 - In the Preset Select screen, ▲ and ▼ to highlight a Mode Preset (F)
 - SELECT** to access Preset Options screen. ▲ or ▼ to highlight **LOAD** or **DELETE** (G)
 - LOAD** will immediately return E4 to Operation screen with the selected Mode Preset active.
 - DELETE** will prompt a Delete Confirm warning message (H): **DELETE** to remove Mode Preset (return to Preset Select screen) or **CANCEL** (return to Preset Options screen).



A: Protocol to be saved



B: Mode Preset Option



C: Preset Select screen



D: Enter Preset filename

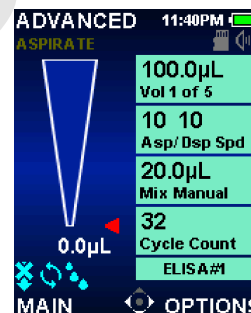

E: Preset ready to run



F: Preset Select screen

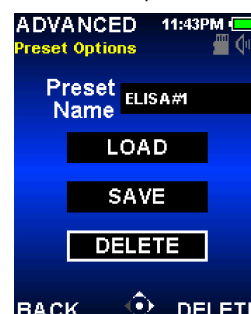

G: Preset Options screen

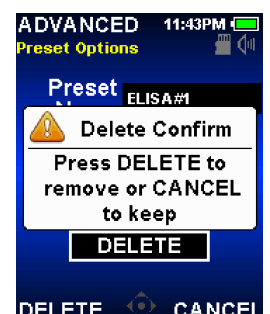

H: Delete Confirm screen

7. To LOAD or DELETE and existing Mode Preset:
 - a. Edit the Mode Options and Settings to your new preferred combination (I)
 - b. Select OPTIONS and ▲ and ▼ to highlight Mode Preset Options (J)
 - c. ► or ● SELECT
 - d. Use ▲ or ▼ to highlight the Preset to edit on the Preset Select screen, then press SELECT (K)
 - e. Use ▲ or ▼ to highlight the SAVE on the Preset Options screen (L)
 - f. SAVE opens the Filename screen with the selected Preset name indicated (M).
 - g. SAVE again **without changing the Preset name** to edit the existing Preset. Confirm SAVE (N).
 - h. Changing the preset name in step (g) above will save your edited Preset as a new Preset (O/P) without changing the one you selected in step (d) above.

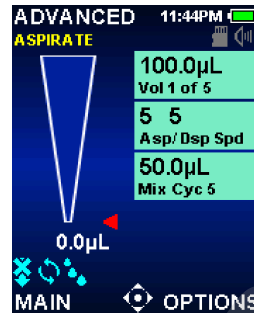

I: New Protocol



J: Mode Preset Option



K: Preset Select screen

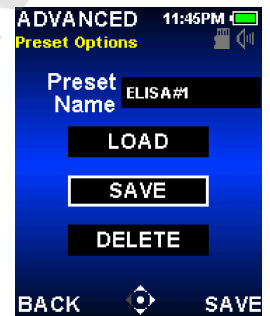

L: Preset Options screen



M: Enter Preset filename



N: Save Confirm screen



O: Enter Preset filename

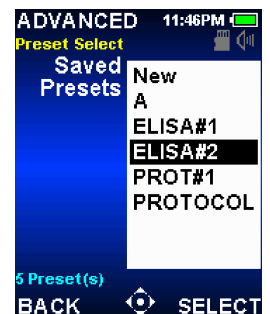

P: New Preset saved

1.14 Service Mode



Service Mode allows users to view information specific to E4 XLS such as the serial number, firmware version and the full service log. In addition, usage logs including the number of pipetting cycles or days in use can be viewed and tracked for GLP purposes. To access Service Mode, ◀ or ▶ in the Level II Menu to highlight **SERVICE** and ●, ▲ or ▼ to enter.

Navigation of Service Pages

- To move between pages, ▶ or ▼ for the next page and ◀ or ▲ for the previous page. The current page will be displayed in the upper left of each screen.
- **HELP** for a detailed description of the highlighted item or page
- **MAIN** to return to the Level II Menu

Identification Page

This page contains pipette-specific identification details (Figure 23). This information is entered at the time of manufacture and is not user-settable:

- **Serial Number**
- **Manufacture Date**
- **Model Number**
- **Firmware Version**

Note: When new firmware is downloaded to E4 XLS, the firmware version number displayed on the identification page will update automatically.

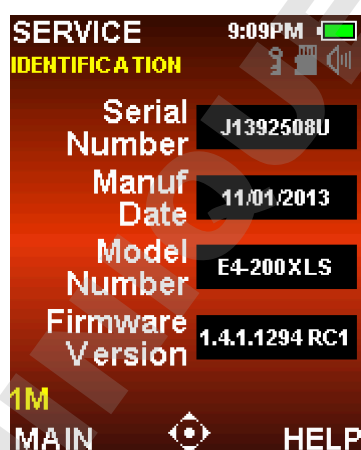

Figure 23: Identification Page

Status Page

This page displays the pipette's usage logs (Figure 24). These values are tracked and logged automatically and are not user-settable:

- **Days Since Service.** Logs the number of days the pipette has been in use since it was last serviced.

- **Cycles Since Service.** Logs the number of aspirate/dispense cycles the pipette has executed since it was last serviced.
- **Lifetime Cycles.** Logs the total number of aspirate/dispense cycles the pipette has executed since it was first put into active use.

Note: The Days and Cycles Since Service logs will reset to zero after each pipette service is performed.

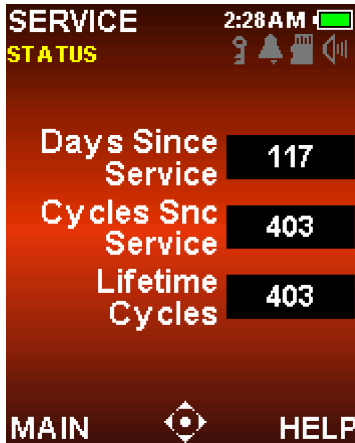

Figure 24: Status Page

Service Log

This page displays a historical log of the last 32 services performed on the pipette (Figure 25). This information is entered by a service technician and is not user-editable.

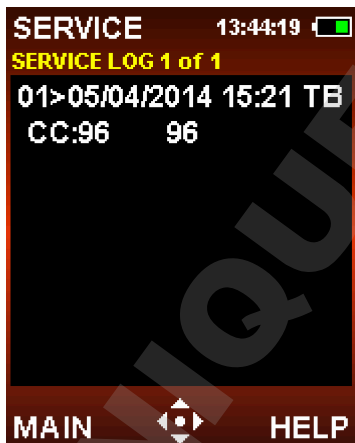

Figure 25: Service Log

For each service entry logged:

- The first line in an entry contains the date and time of service and technician ID
- The next line in an the entry contains the number of cycles executed since the last service, and the total number of lifetime cycles at the time service was performed.

1.15 Battery Charging

Unlike other battery types, the Li-Ion battery in E4 has no “memory effect” and does not need to be fully discharged. Pipettes can be charged using the Wall Power Supply, the optional Rapid Charge Stand or with a PC using the optional USB cable.

The battery charge indicator in the top right corner of the display will change as the unit is charging. After 15 minutes, the pipette will have enough charge for a few hours of pipetting, and a full charge will be obtained after approximately 90 minutes and will provide up to 3000 full-stroke cycles (fewer in large-volume models).

When charging is complete, the battery charge indicator will be solid green, indicating a full battery. As the battery depletes with use, the green bar will drop accordingly.

Wall Power Supply



To install the universal Wall Power Supply and charge E4, connect the power cord to a power outlet. Connect the other end of the cord to the Micro USB port located on the top of the unit. The pipette can be operated while connected to the Wall Power Supply cord.

Figure 26: Operating the pipette while connected to E4-WPS Wall Power Supply

Rapid Charge Stand

To use, connect the universal Rapid Charge Stand power cord to a power outlet and connect the other end of the cord to the power socket on the back of the Rapid Charge Stand. For convenience, you can dress the cable along one of the vertical support legs using the channels provided. See Figure 27 B.



Figure 27: A: E4-RCS holding E4 XLS+ pipettes. B: Back of E4-RCS showing power cord connected and dresses along support leg

The E4-RCS Rapid Charge Stand will charge three E4 XLS+ pipettes simultaneously in about 90 minutes. Charging contacts mate with contacts under the pipette head.

Rainin recommends storing E4 XLS+ on the stand when not in use. This practice will provide a safe storage place, and the pipette will always be fully charged.

USB Cable

To charge E4 XLS with a PC using the optional USB cable, connect the cable's USB connector to a computer USB port. Connect the other end of the cable to the USB outlet located on the top of E4 XLS. Rainin does not recommend operating E4 XLS when the pipette is connected to a computer for charging.

(Note that charging E4 XLS with a PC will take approximately 2–3 times longer than using the Wall Power Supply or the Rapid Charge Stand.)

Electrical Specifications

This device is intended for use only with Rainin power sources with the part numbers listed below.

*Rainin-supplied power supplies are LPS (Limited Power Source) certified. No other power sources may be used with this device.

It is important that the Wall Power Supply and Rapid Charge Stand can quickly be disconnected from AC power, in case a hazard arises.

| Source | Part No. | Input | Output* |
|---------------------|----------|-----------------------|--|
| Rapid Charge Stand: | E4-RCS | 100-240 VAC, 50/60 Hz | 5 VDC, 4A |
| Wall Power Supply: | E4-WPS | 100-240 VAC, 50/60 Hz | 5 VDC, 2A |
| Battery | E4-BATT | | Li-Ion 3.7 VDC Nominal 1250 mAh Nominal |

Explanation of symbols:

Hz = Hertz, A = Amperes, mAh = Milliamp Hour, VAC = Volts Alternating Current, VDC = Volts Direct Current.

1.16 Replacing the Battery

E4 XLS user settings are retained if the battery is removed or replaced.

1. Open the battery compartment by sliding the compartment door open.
2. Remove the old battery by sliding it out.
3. Align the replacement battery connector plug with the socket in the battery compartment as shown in Figure 28. Slide the battery into place. Once the battery is installed properly, the pipette will turn on automatically, initialize and display the start-up screen.
4. Replace the battery compartment door.



Figure 28: Replacing the Battery

The battery life is dependent on such factors as:

- Pipette volume range
- Full-range or part-range pipetting
- Multidispensing
- Display brightness and display timeout settings

1.17 Storage

After use, store the pipette in a clean safe place. E4 XLS+ is a precision instrument and should be treated with the level of care appropriate for laboratory instrumentation.

Rainin recommends storing E4 XLS on the Rapid Charge Stand if one is available. If not, three hangers are available to hold E4 XLS conveniently when not in use:

- CR-7: Free-standing carousel that holds three pipettes.
- HU-M3: Set of three individual magnetic Hang-Ups™ for mounting on ferrous surfaces.
- HU-S3: Three Hang-Ups attached to a clamp that fits onto a shelf.

Note: All of the hangers listed above require a HU-A3 Adapter.

1.18 Tip Ejector Arm Removal⁵²

Four types of tip ejector are used and all types can be removed with minimum effort – do not use force.

For models up to 2000 µL

Metal tip ejector: press in the quick-release tabs on the ejector arm and pull the arm down.

Plastic tip ejector: grasp firmly on the ejector arm and pull down.

For 5000 µL & 10 mL models: grasp the top of the ejector arm and pull out then down.

For the 20 mL model: pull off the lower part of the ejector arm; the upper part stays in place. (Replace by aligning the rod with the hole in the upper part and pressing firmly.)

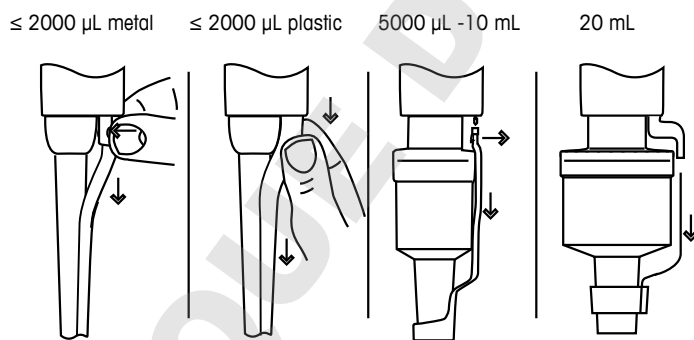

Figure 29: Removing the Tip Ejector

To replace the ejector arm (except 20 mL described above), insert the shaft through the large opening, align the top of the ejector arm with the tip ejector push-rod, and push the ejector arm firmly until it is securely in place.

1.19 Care and Maintenance

E4 XLS pipettes are sophisticated lab instruments and should be treated with appropriate care. These pipettes should provide years of trouble-free service if the operating recommendations in this manual are followed.

The most important factor in taking proper care of E4 XLS is to keep the mechanism dry and clean. The following simple rules should be strictly observed:

1. Never allow liquid to enter the shaft where it can contact the piston or seal.
1. Never allow liquid to enter the electronics, including the display, soft keys and joystick.
2. Never pick up liquid without a tip attached.
3. Never invert the pipette or lay it on its side with liquid in the tip. Always hold E4 XLS upright and store upright if possible. The Rapid Charge Stand holds three E4 XLS pipettes and charges them simultaneously.
4. Never use aggressive solvents to clean E4 XLS. It is best use a lint-free wipe dampened with water with dilute mild detergent, if needed, to clean the instrument. Be sure to keep the display, soft keys and joystick dry.
5. Never attempt to recharge E4 XLS with a device other than the Rainin E4-WPS Wall Power Supply, the E4-RCS Rapid Charge Stand or the E4-USB cable. Severe damage to the internal electronics will result.

Sample contamination of the shaft, seals or piston can cause rough, sticky plunger movement. Eventually deposits on the piston can cause the seal to tear, leading to inaccurate results. Best practice for pipette maintenance is to regularly clean the pipette liquid end with the following procedure:

1. Remove tip ejector arm (See Tip ejector arm removal Figure 29).
2. On pipettes up to 1000 μL unscrew the shaft coupling nut and remove shaft. For 2000 μL unscrew the shaft. For pipettes >2000 μL unscrew the lower part of the shaft.
3. When you remove the piston assembly, note the order and placement of the seals, retainers, springs and o-rings on the piston assembly. XLS+ seals for models 100-2000 μL are asymmetrical and must be inserted in the correct orientation (See figure 30 A and B). XLS+ seals for models 2-20 μL are symmetrical and can be used in either orientation.

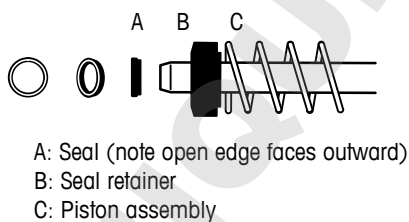

Figure 30A: Seal orientation,
100, 200 and 300 μL

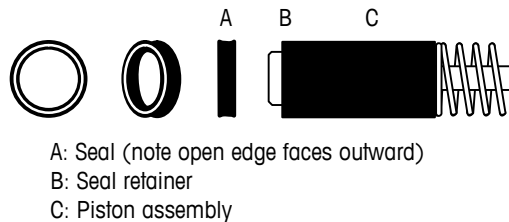

Figure 30B: Seal orientation,
1000 and 2000 μL

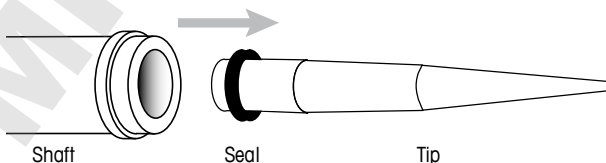

Figure 30C: Using the large end of a tip to remove 1000 or 2000 μL XLS+ seal from the shaft

4. XLS+ seal sizes 1000-2000 μL may remain inside the shaft when you remove the piston assembly; this is normal for this design. The seals may be removed from the shaft by inserting the large end of a tip into the shaft (See Figure 30 C) and hooking the seal over it.

5. To inspect and clean seals sized 100-300 µL, remove them gently from their retainers by pushing them out from the back side, preferably with a non-sharp object like a pipette tip.
6. Inspect the seals, retainers, o-rings, shaft and piston for contamination. Clean with a lint-free cloth with either distilled water or isopropyl alcohol. Apply grease (part number 6200-524, 17014531) sparingly by gently rubbing the seal or o-ring between the thumb and index finger, ideally using a clean powder-free examination glove. Apply a small amount of grease on the piston as well.
Reassemble in the correct order and orientation.
7. If piston corrosion or staining is evident do not use the pipette and have a METTLER TOLEDO Service representative assist with replacement of the piston.
8. The shaft, tip ejector and handle may also be cleaned using a damp cloth with distilled water, 10% bleach solution, isopropyl alcohol, or any commercially available instrument decontamination solution. Be sure to rinse off the cleaning agent with distilled water

1.20 Autoclaving

Autoclaving of your pipettes to perform sterilization may be performed at 121°C, at 1 Bar, for 15-20 minutes, with the following restrictions and guidelines.

Do not autoclave the entire pipette or any part not specifically identified in the table below.

| Pipette line | Model Range | Autoclaveable parts |
|-----------------|---------------------------------------|---|
| E4 XLS | All single channel models | Shaft and tip ejector |
| E4 XLS+ | Single channel models 2 - 2000 µL | Shaft, tip ejector, piston assembly, spring, seal, and seal retainer |
| E4 XLS, E4 XLS+ | All multichannels, adjustable spacers | None |

The entire liquid end of E4 XLS+ single channel pipettes may be removed and placed into the autoclave without disassembling individual parts. The liquid end includes the following: Shaft, tip ejector, piston assembly (with spring), seal and seal retainer. If you have upgraded the seals of an older E4 XLS to the new XLS+ seals (see section 1.21), you can now autoclave the entire liquid end of your pipette. If you are unsure of your model type see section 1.21.

If autoclaving more than one unit together, take care to reassemble your pipettes with all of their original parts. If you clean the XLS+ piston and seals before autoclaving then be sure to re-grease them afterwards (see Care and Maintenance).

See Care and Maintenance and Replacement Parts sections for more details on disassembling pipettes, and how to identify the different parts.

-

1.21 Upgrading your Liquid End to XLS+

The XLS+ single channel line of pipettes is distinguished from earlier models by having a new lower stiction sealing system, a completely autoclaveable liquid end, and a durable, corrosion-free plastic tip ejector.

If you have a single channel E4 XLS pipette in the 2-2000 µL range, you can upgrade your liquid end to experience the superior benefits of XLS+.

You can differentiate an XLS+ pipette from the earlier XLS version in the following ways: an original XLS+ pipette will have a serial number beginning with C14 (or higher) but not A14 or B14. Also the RAININ logo on the silver badge is colored blue. All the XLS+ seals are black, and no o-rings are used, while the XLS seals are white, and o-rings sit below the seal on the piston.

You can upgrade your liquid end by ordering the seal replacement kit (see Replacement Parts). The new XLS+ seals require grease part# 6200-524 17014531 (see Care and Maintenance). For the 1000 and 2000 μL models, replacing the seal retainer requires specialized tools and handling to avoid damage to the piston. Please call technical support (800-543-4030 in the USA) or your local METTLER TOLEDO service provider.

1.22 Troubleshooting

| Problem | Possible Cause | Suggested Remedy |
|--|--|---|
| Leaks, inaccuracy | Loose shaft | Tighten coupling nut by hand. |
| | Worn seal for pipette volumes $\leq 2000 \mu\text{L}$ | Replace seal |
| | Worn o-ring or insufficient grease seal for pipette volumes 5000 μL , 10mL, 20 mL | Replace o-ring and apply small amount of grease. |
| | Cracked or split shaft. | Replace shaft. Check piston is not bent. If bent, call Rainin service for a new piston. Call 800-543-4030 in the US. |
| Rough, jerky, or sticky plunger movement | Contamination inside mechanism. | Remove tip ejector arm, remove shaft and check piston and seal clean as described in Care and Maintenance section. If piston is permanently corroded or stained, call Rainin service for a new piston. Call 800-543-4030 in the US. |
| | Insufficient grease | Apply grease sparingly to seal or o-ring |

When removing the shaft from the pipette body, make sure the spring, seal and o-ring do not detach from the piston, especially on smaller models. Be careful not to bend the piston on these small models. Recalibration of the pipette is only required when the piston is replaced.

Acids and Corrosives

Extensive contact with corrosive fumes may result in premature seal wear and damage to the piston. Exposure of the internal components to corrosive aerosols and fumes may be reduced by using Rainin tips with aerosol barrier filters. After using concentrated acids or corrosive solutions, disassemble E4 XLS and inspect and clean the piston assembly, shaft and seal/o-ring with distilled water. Use extreme care on the 10 μL models to avoid damaging the small diameter piston, or losing small items such as seals. Dry all components thoroughly and reassemble.

Warning Messages

E4 XLS+ monitors itself to inform you of important issues such as battery levels, USB connection, charge stand connection, factory reset, real time clock status and more. Any changes to these variables that could affect your operation of the pipette will be reported as a Warning message. Some warnings require action, such as recharging the unit or resetting the clock, while others are informational only ("Memory Clear" after factory reset). To exit any warning message, press the left softkey (CONT). If a warning message is displayed during the E4 XLS power up sequence that cannot be reset, note the error number and contact Tech Support at 800-543-4030 in the US. In other countries contact METTLER TOLEDO or your distributor.

Error Messages

E4 XLS+ is a sophisticated product that is dependent on a complex mix of electronic hardware and software components. In any complex system such as this, faults may occasionally occur. These are usually due to unexpected software conditions (invalid data, conflicting settings, etc.) or hardware related failures (invalid or no

response). An Error message informs you that a fault has been detected. Press the left softkey (CONT) and the unit will reset itself while performing a diagnostic test. Most of the time, the unit will fix itself, and pipetting can be resumed normally. If the error messages continue, please cease pipetting, note the error code and message, and call Tech Support at 800-543-4030 in the US. In other countries contact METTLER TOLEDO or your distributor.

1.23 Micro-SD Card Management and Firmware Upgrades

Introduction

With the release of the Rainin E4 firmware V 1.4 the included micro-SD card will add new functionality to the pipette. In previous firmware versions only PureSpeed™ protocols used the micro-SD card. Now the new 'Preset' features will also use the SD card.

Inserting and removing the SD card

New pipettes with version 1.4 firmware will come with a Rainin micro-SD Card preinstalled. To upgrade older pipettes, a Rainin micro-SD Card can be purchased from Rainin or an authorized distributor. Please see below for ordering information.

The micro-SD card is located in a small slot on the left side beneath the battery compartment (as seen from the back of the pipette). A label under the battery door identifies the location of the SD-card. See A below.



To change or insert a new SD card, remove the battery compartment door and the battery. Insert the card with minimal force into the SD-card slot as shown in the figure with the metal contacts facing down. Push the card with your fingernail or a small, blunt non-conductive object (e.g. an unused pipette tip) into the slot until a slight "click" can be felt or heard.

To remove the card, use a similar tool: Push in the card until a click is heard, then release the card and the spring in the card socket will push the card out a little bit and it can be removed. Do not touch the metal contacts of the card. Store in a clean, dry and cool environment.

If the card is inserted or removed while the pipette is powered on, a message will appear on the screen and inform about the card insertion or removal and the pipette will restart.

After the SD-card is inserted properly and the pipette powered on, an SD card system icon is displayed and the SD card functions like "Presets" and "PureSpeed" become available.

Model-specific Presets and Interchanging micro-SD cards

Presets are model-specific. Presets stored on micro-SD cards are only interchangeable between models with the same volume e.g. 200 µL single, 8 and 12 channel pipettes. If the SD-card is transferred to a pipette with a different volume, existing saved presets will not show up but new presets can be saved for the different model.

Troubleshooting

If you get an SD card error message, please confirm that the card is properly inserted into the pipette and is clean and undamaged. If the error message persists, or preset files are not readable, please contact Rainin Tech Support at tech.support@rainin.com.

Ordering SD cards and Upgrading older E4 models

To order new micro-SD cards, use part# 17012587, Model PT-E4-SD. The new E4 functions require at least firmware version 1.2 for PureSpeed™ and version 1.4 for Mode Presets and Admin mode. If you have an E4 unit with older firmware, please contact your local MT representative to upgrade your firmware.

1.24 Service, Calibration and Repair

It is recommended to use only genuine Rainin replacement parts such as seals, o-rings, and shafts. It is NOT necessary to recalibrate the pipette after changing the seal, o-ring, or shaft. Recalibration of the pipette is only necessary when the piston is replaced, and should be done only by qualified factory-trained personnel in a Rainin approved facility.

For pipettes under warranty, please note that the warranty will be voided if the pipette has been damaged as a result of physical or chemical abuse, or if the pipette has been repaired or recalibrated by any service facility which is not authorized by Rainin. In the US, call 800-543-4030 for service. Service is also available outside the US. See www.mt.com/rainin for more information.

1.25 Replacement Parts

The commonly-replaced parts are shown here for each volume range for E4 XLS, single-channel LTS and universal-fit models.

The images in Figure 31 represent the 20, 200 and 1000 µL models (top) and the 10 mL model (bottom) – other models are similar.

| XLS+ Models ≤2000 µL | Seal replacement kit ^{1,3,5} | Order # | Shaft ¹ | Order # | Tip Ejector Metal ¹ | Order # | Tip Ejector Plastic ² | Order # |
|---------------------------------|---------------------------------------|----------|--------------------|----------|--------------------------------|----------|----------------------------------|----------|
| E4-10XLS+ | 6200-511 | 17014518 | 6202-064 | 17004862 | 6202-071 | 17005287 | 6200-517 | 17014524 |
| E4-20XLS+ | 6200-512 | 17014519 | 6202-065 | 17004861 | 6202-071 | 17005287 | 6200-517 | 17014524 |
| E4-100XLS+ | 6200-506 | 17014513 | 6202-066 | 17004859 | 6202-073 | 17005293 | 6200-518 | 17014525 |
| E4-200XLS+ | 6200-513 | 17014520 | 6202-067 | 17004860 | 6202-073 | 17005293 | 6200-518 | 17014525 |
| E4-300XLS+ | 6200-514 | 17014521 | 6202-425 | 17007551 | 6200-419 | 17007556 | 6200-519 | 17014526 |
| E4-1000XLS+ ⁴ | 6200-515 | 17014522 | 6202-068 | 17004858 | 6202-074 | 17005294 | 6200-520 | 17014527 |
| E4-2000XLS+ ⁴ | 6200-516 | 17014523 | 6202-214 | 17004856 | 6200-168 | 17005296 | 6200-521 | 17014528 |
| SE4-10XLS+ | 6200-511 | 17014518 | 6200-140 | 17004845 | 6200-133 | 17005292 | 6200-522 | 17014529 |
| SE4-20XLS+ | 6200-512 | 17014519 | 6200-145 | 17004847 | 6200-144 | 17005288 | 6200-517 | 17014524 |
| SE4-100XLS+ | 6200-506 | 17014513 | 6200-147 | 17004848 | 6200-148 | 17005289 | 6200-523 | 17014530 |
| SE4-200XLS+ | 6200-513 | 17014520 | 6200-157 | 17004849 | 6200-156 | 17005291 | 6200-518 | 17014525 |
| SE4-300XLS+ | 6200-514 | 17014521 | 6200-413 | 17007554 | 6200-419 | 17007556 | 6200-518 | 17014525 |
| SE4-1000XLS+ ⁴ | 6200-515 | 17014522 | 6200-160 | 17004850 | 6200-163 | 17005290 | 6200-520 | 17014529 |
| SE4-2000XLS+ ⁴ | 6200-516 | 17014523 | 6200-169 | 17004846 | 6200-168 | 17005296 | 6200-521 | 17014530 |
| Grease for all models: 6200-524 | | 17014531 | | | | | | |

| XLS Models ≥5000 µL | Piston O-Ring | Order # | Cylinder O-Ring | Order # | Shaft | Order # | Tip Ejector | Order # |
|---|---------------|-------------------------|-----------------|----------|-------------------------|----------|-------------|----------|
| E4-5000 XLS | 6200-363 | 17003382 | 6200-364 | 17003477 | 6202-222 | 17004857 | 6200-373 | 17005297 |
| E4-10ML XLS | 6200-369 | 17003383 | 6200-370 | 17003476 | 6202-223 | 17004855 | 6200-374 | 17005295 |
| E4-20ML XLS | 6202-299 | 17003413 | 6202-300 | 17003478 | 6202-302 | 17004908 | 6202-298 | 17005308 |
| SE4-5000 XLS | 6200-363 | 17003382 | 6200-364 | 17003477 | 6200-362 | 17004852 | 6200-373 | 17005297 |
| SE4-10ML XLS | 6200-369 | 17003383 | 6200-370 | 17003476 | 6200-368 | 17004851 | 6200-374 | 17005295 |
| Filters for 5 mL and 10 mL XLS models: 6190-164 | | 17001944 (pack of 100). | 6190-165 | | 17001945 (pack of 1000) | | | |
| Filters for 20 mL XLS models: 6190-221 | | 17001951 (pack of 100). | 6190-222 | | 17001952 (pack of 500) | | | |

Notes

1. Parts are back compatible with EDP1, EDP3 and E4 XLS.
2. Parts are back compatible with E4 XLS only.
3. XLS+ seals and retainers must be used together.
4. 1000 μ L and 2000 μ L EDP1, EDP3 and E4 XLS models require service to upgrade to XLS+ seal retainers.
5. Seal replacement kit includes seal, seal retainer, and grease.

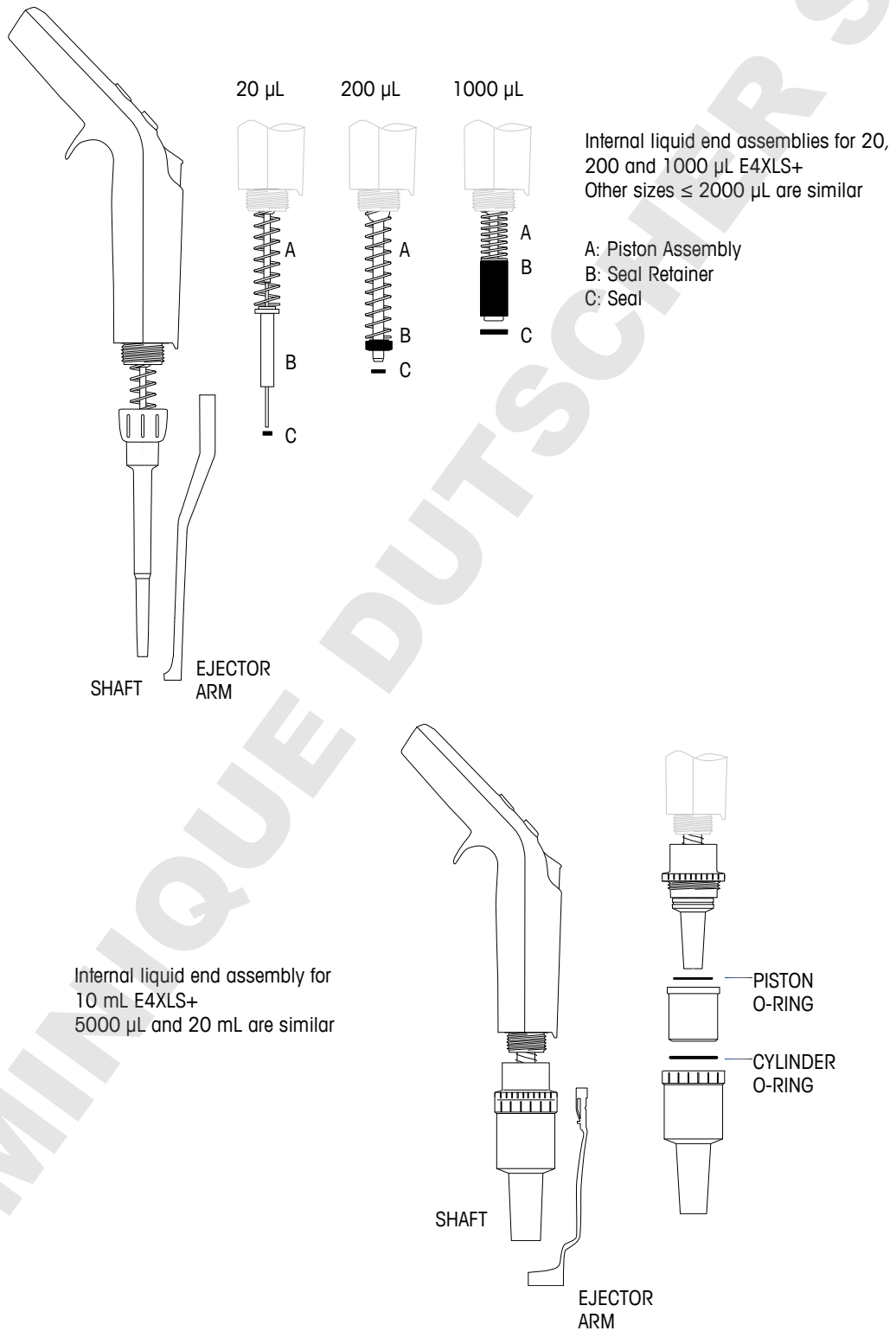

Figure 31: Common Replacement Parts
Top < 2000 μ L Bottom > 5000 μ L

2 RFID (Radio Frequency Identification Device)

2.1 Description and Operation

All E4 XLS models incorporate a passive RFID tag in the finger-hook. The tag contains unique information about the pipette including model type, serial number, RFID UID and service calibration information. The RFID tag can be wirelessly linked with the optional reader and software to facilitate querying calibration tracking and service reminders. The RFID tag is of negligible weight and has no effect on precision or accuracy. It operates only when read by an RFID reader and the associated software.

Optional Rainin RFID Reader

Rainin recommends the Rainin RFID Reader which interfaces with a PC USB port, and does not recommend any other RFID readers. Using the Rainin RFID Reader, information can be written to the pipette's RFID tag in the same consistent way as it is read from the RFID tag. The Rainin RFID Reader requires LabX™ Direct Pipette-Scan™ Software for read/write capability. The estimated range of operation of the RFID reader is up to 5 cm.

Rainin RFID Reader LED Indicators

| LEDs | Description |
|----------------|---|
| Yellow & Green | Reader powers up in this state and reverts to this state when the application is stopped or a plug-in is disabled. |
| Yellow | Reader has detected a pipette. Keep pipette close to reader until LED changes to Green (or Red). |
| Green | When the application first starts, the Green LED indicates the device is ready. After all data is read from a pipette, the Green LED lights up. |
| Red | Reader failed to read or write. Try scanning the pipette again. If the LED stays red, restart the software. |
| Yellow & Red | Data written to the pipette does not match the data read back from the pipette. |

Optional LabX Direct Pipette-Scan Software

Supplied on the same CD as this manual is a trial version of the LabX Direct Pipette-Scan software. A full version is also available for purchase. Supported PC Operating Systems include: Microsoft Windows XP, Vista and Windows 7. Users can select any of the following languages: Chinese (Simplified), Czech, Danish, English, French, German, Hungarian, Italian, Japanese, Korean, Norwegian, Polish, Russian, Spanish, and Swedish.

Operation Overview

The optional RFID Kit contains a Rainin RFID Reader and LabX Direct Pipette-Scan software. Once the Rainin RFID Reader is connected via USB to a PC and the software is configured and running, operation is simple.

Place the head of the pipette over the Rainin RFID reader in the position shown in Figure 32. Hold the pipette steady for a few seconds to allow the pipette information stored in the RFID tag to be scanned and read into the software.



Figure 32: Rainin RFID Reader

Pipette RFID-Tag Read-Only Fields

The software will display the read-only data fields programmed into each pipette's RFID tag before it leaves the factory (Figure 33). These fields can ONLY be modified by Rainin at the time of manufacture or when sent in for service. Read-only fields include: RFID UID, Model Number, Serial Number, Factory Date, Last Service Date and Next Service date. For QC or workflow purposes, multiple RFID enabled pipettes can be scanned sequentially.

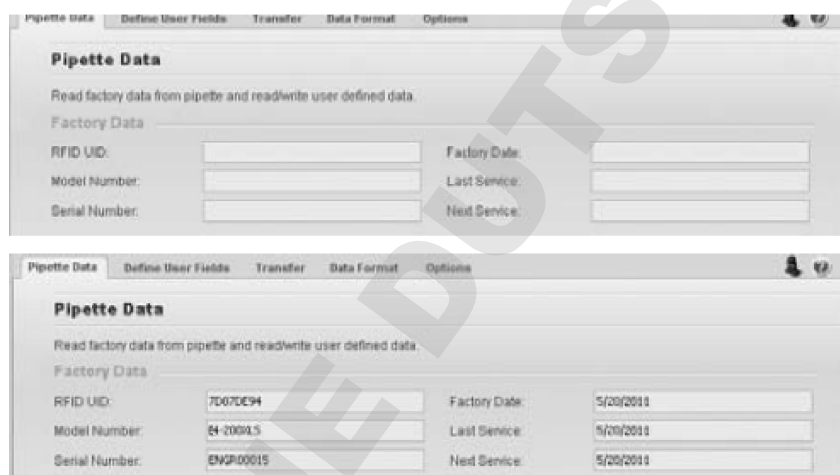

Figure 33: Read-Only Pipette Data in Lab X Direct Pipette-Scan Software: Before Scan (top) and After Scan (bottom)

Writing Data to Custom Fields in the RFID Tag

In addition to read-only fields, several writable fields are available on the RFID tag. These can be customized and/or standardized to suit the needs of an individual user or laboratory.

Custom writing operations require both the Rainin RFID Reader and the LabX Direct Pipette-Scan software. Please refer to the software help file for complete instructions.

RFID/LabX Direct Pipette-Scan Software Benefits

- The flexibility of the LabX Direct Pipette-Scan software assists users in customizing individual workflows
- Entire departments can standardize both workflow and calibration checks when using the E4 XLS pipettes, Rainin RFID Reader and LabX Direct Pipette-Scan software as a complete system

- The system simplifies the Quality Compliance process by shortening the calibration check cycle, allowing pipettes to be returned to active lab use faster
- Custom fields can be configured and written to the RFID tag and advanced workflows can be defined for custom settings
- Information within the tag can be exported to common formats, such as Excel® and Word® as well as Text., to facilitate records-keeping

What RFID Does Not Do

- RFID does not protect against misplacement, theft, or provide a pipette's location
- RFID does not protect against erroneous data input
- RFID does not replace calibration stickers for businesses or displace QC professionals
- RFID does not validate laboratory workflows. The validation of the workflow and 21CFR Part 11 regulatory compliance remains the responsibility of the customer.

3 E4 XLS+ Multichannel Pipettes

3.1 Description and Operation

Introduction

E4 XLS+ multichannel pipettes are based on the E4 XLS single-channel pipette and use the patented LTS LiteTouch Tip Ejection System. Multichannel E4 XLS+ is available in 8-channel and 12-channel versions. An 8-channel version is shown in 2.

The 8- and 12-channel models are available in 6 volume ranges:

- 0.5–10 µL
- 2–20 µL
- 5–50 µL
- 20–200 µL
- 20–300 µL
- 100–1200 µL

Tip Selection

E4 XLS+ multichannel pipettes use Rainin LTS tips.

- Use 20 µL LTS tips with the following E4 XLS+ models: E8-10XLS+, E8-20XLS+, E8/12-10XLS+ and E12-20XLS+.
- Use 250 µL LTS tips with the following models: E8-50XLS+, E12-50XLS+, E8-200XLS+, and E12-200XLS+.
- Use 300 µL LTS tips with E8-300XLS+ and E12-300XLS+
- 1200 µL LTS tips are recommended for E8-1200XLS+ and E12-1200XLS+. Non-filter 1000 µL LTS tips can also be used as they will pick up 1200 µL.

LTS tips have a cylindrical cross-section with a well-defined seal ring, thin wall, and positive stop. They seal properly on the shaft and cannot be jammed or forced too far onto the shaft nozzles, and provide absolutely consistent sample pickup across all channels.

Mounting LTS Tips

Mounting racked LTS tips on L8 and L12 pipettes is simple.

1. Align the shaft nozzles into the row of tips, holding the pipette at an angle (Figure 35 left).
2. Position the pipette upright and press the nozzles into the tips until the “positive stop” is reached (Figure 35 right).

The tips are now mounted with proper sealing. There is no need to hand-tighten, use heavy pressure, or rock the nozzles onto the tips to obtain a good seal.



Figure 34: E4 XLS+ MultiChannel Pipette



Figure 35: Mounting Racked LTS Tips

Tip Immersion Depth

The recommended depth for tip insertion is shown in the table below.

| Pipette Model | Immersion Depth |
|---|-----------------|
| E8-10XLS+, E12-10XLS+ E8-20XLS+, E12-20XLS+ | 2-3 mm |
| E8-200XLS+, E12-200XLS+, E8-300XLS+, E12-300XLS+, E8-1200XLS+, E12-1200XLS+ | 3-6 mm |

Operate the pipette within 20 degrees of vertical.

Tip Ejection

Simply press on the tip ejector button. All tips are ejected cleanly with minimal pressure on the thumb because of the progressive eject design built in to the liquid end manifold.

Positioning the Liquid End Manifold

The liquid end manifold can be rotated to any angle for convenience when filling plates. There is no need to loosen the coupling nut.

Note: Unique tips for 1200 μ L models

The RT-L1200 and RT-L1200S tips are specifically designed for use with 1200 μ L models in MULTIDISPENSE mode. The unique design of these tips prevents drop formation and eliminates the need for touch-off between dispenses in MULTIDISPENSE mode.

The RT-L1200F aerosol-resistant tip allows a full 1200 μ L to be aspirated under the filter. However, fluid dynamics dictate that touch-off may be required when multidispensing.

4 E4 XLS Adjustable Spacer Pipette

4.1 Description and Operation

Introduction

E4 XLS Adjustable-Spacer multichannel pipettes are based on E4 XLS single-channel models, and operate in the same way. Two versions of the E4 XLS Adjustable-Spacer pipette are available: 6-channel (LA6) and 8-channel (LA8). Nozzle spacing adjustment ranges are listed below:

6-channel: 9 mm to approximately 19 mm

8-channel: 9 mm to approximately 14 mm

6-channel versions are available in the following volume ranges:

20–300 µL

100–1200 µL

8-channel versions are available in the following volume ranges:

5–50 µL

20–300 µL

100–1200 µL

Spacing Controls and Indicators

Nozzle spacing is changed with the use of two knurled knobs on either end of the liquid end manifold: the SPACING ADJUSTMENT knob and the LIMITER knob, shown in Figure 36.

The LIMITER knob, which is marked with the nozzle spacing range, sets the desired maximum spacing within the pipette's spacing range. A vertical arrow at the top of the knob on the liquid end manifold is the set point, shown in Figure 37.

When the maximum spacing with the LIMITER knob has been set, turn the SPACING adjustment knob to open the nozzle spacing to the set value. A scale on the liquid end manifold gives a visual reference of the set spacing. Simply line up the leftmost nozzle with the scale on the manifold.

The full range of adjustment for the 8-channel version is shown in Figure 38. Nozzles are set to 9 mm spacing on the left, and 14 mm spacing on the right.



Figure 36: E4 XLS Adjustable Spacer
A: SPACING ADJUSTMENT
B: LIMITER



Figure 37: Limiter Set Point

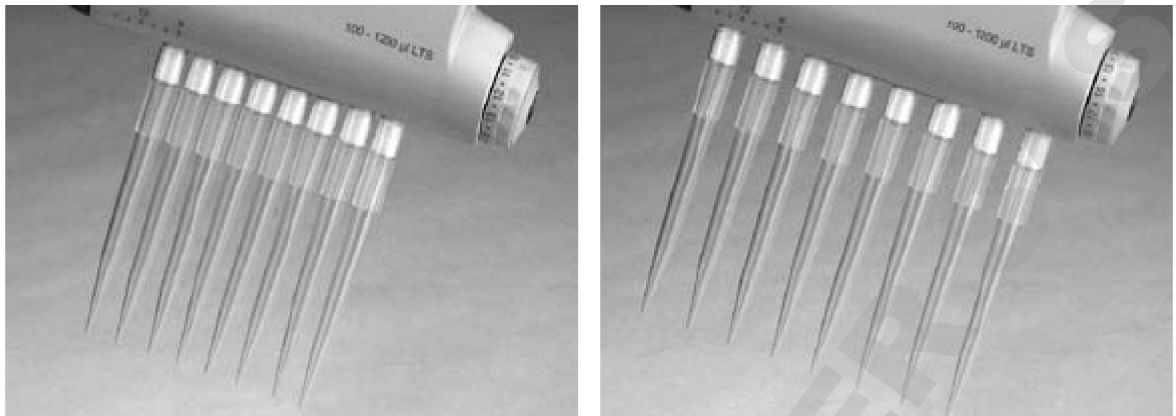

Figure 38: Nozzles: Minimum Spacing (left) and Maximum Spacing (right)

Tip Selection

E4 XLS multichannel pipettes use Rainin LTS tips. Use 250 μL LTS tips with the EA-50XLS. Use 300 μL LTS tips with the EA6-300XLS and EA8-300XLS. 1200 μL LTS tips are recommended for the EA6-1200XLS and EA8-1200XLS. Non-filter 1000 μL LTS tips can also be used as they will pick up 1200 μL .

LTS tips have a cylindrical cross-section with a well-defined seal ring, thin wall, and positive stop. They seal properly on the LTS nozzles and cannot be jammed or forced too far onto the nozzles.

Mounting LTS Tips

Mounting racked LTS tips on Adjustable Spacer XLS pipettes is simple.

1. Set the nozzle spacing to 9 mm (same as the spacing for racked tips) by rotating the dark grey SPACING ADJUSTMENT knob fully clockwise.
2. Align the nozzles into the row of tips, holding the pipette at a slight angle (Figure 39 left).
3. Rotate the pipette upright and press the nozzles into the tips until the “positive stop” is reached (Figure 39 right).

The tips are now mounted with proper sealing. There is no need to hand-tighten, use heavy pressure, or rock the nozzles onto the tips to obtain a good seal. Withdraw the tips from the tip rack.



Figure 39: Mounting LTS Tips

Setting the Nozzle Spacing

With tips mounted on the nozzles, and before aspirating sample:

- If the spacing for the receiving wells or test-tube block is known, set this value on the LIMITER knob.
- If the spacing is not known, hold the pipette so that the tip ends are above the centers of the wells or test-tube block into which sample will be dispensed. Look at the scale on the liquid end manifold, and note where the marked nozzle aligns. Set this value on the LIMITER knob.
- If the spacing is over-extended, simply click the LIMITER knob to smaller values, stopping when the tip ends are aligned over the centers of the wells/test tubes.

Once the LIMITER knob has been set, spacing the nozzles properly is simple:

1. Aspirate the sample(s).
2. Set the nozzle spacing by moving the SPACING ADJUSTMENT knob until it stops at the value set by the LIMITER knob.
3. Dispense into the wells or test-tube block.

Tip Immersion Depth

The recommended depth for tip insertion is shown in the table below.

| E4 XLS Model | Immersion Depth |
|--|-----------------|
| EA8-50XLS | 2–3 mm |
| EA6-300XLS, EA8-300XLS, EA6-1200XLS, EA8-1200XLS | 3–6 mm |

Operate the pipette within 20 degrees of vertical.

Tip Ejection

Simply press on the tip ejector button. All tips are ejected cleanly with minimal pressure on the thumb because of the progressive eject design built in to the liquid end manifold.

Positioning the Liquid End Manifold

The liquid end manifold can be rotated to any angle for convenience. There is no need to loosen the coupling nut.

Note: Unique tips for 1200 µL models

The RT-L1200 and RT-L1200S tips are specifically designed for use with 1200 µL models in MULTIDISPENSE mode. The unique design of these tips prevents drop formation and eliminates the need for touch-off between dispenses in MULTIDISPENSE mode.

The RT-L1200F aerosol-resistant tip allows a full 1200 µL to be aspirated under the filter. However, fluid dynamics dictate that touch-off may be required when multidispensing.

5 Appendices

5.1 Speed Table (all times in seconds)

| Single Channel: 10, 20, 100, 200, 300, 1000, 2000 uL 8 & 12 Channel: 10, 20, 50, 200, 300 uL | | | | | |
|---|--------------------|--------------------|--------------------|------------------|------------------|
| Speed # | Full Aspirate Time | Full Dispense Time | Blowout Home Delay | Blowout Duration | End Blowout Hold |
| 10 | 0.55 | 0.55 | 0 | 0.13 | 1.0 |
| 9 | 0.70 | 0.70 | 0.4 | 0.17 | 1.0 |
| 8 | 0.89 | 0.89 | 0.6 | 0.21 | 1.0 |
| 7 | 1.13 | 1.13 | 0.8 | 0.27 | 1.0 |
| 6 | 1.45 | 1.45 | 0.85 | 0.35 | 1.0 |
| 5 | 1.90 | 1.90 | 1 | 0.46 | 1.0 |
| 4 | 2.39 | 2.39 | 1.5 | 0.57 | 1.0 |
| 3 | 2.92 | 2.92 | 1.7 | 0.70 | 1.0 |
| 2 | 3.46 | 3.46 | 1.9 | 0.83 | 1.0 |
| 1 | 4.10 | 4.10 | 2.5 | 0.98 | 1.0 |

| Single Channel: 5, 10, 20 ML 8 & 12 Channel: 1200uL | | | | | |
|--|--------------------|--------------------|--------------------|------------------|------------------|
| Speed # | Full Aspirate Time | Full Dispense Time | Blowout Home Delay | Blowout Duration | End Blowout Hold |
| 10 | 1.13 | 1.13 | 0 | 0.27 | 1.0 |
| 9 | 1.45 | 1.45 | 0.4 | 0.35 | 1.0 |
| 8 | 1.90 | 1.90 | 0.6 | 0.46 | 1.0 |
| 7 | 2.39 | 2.39 | 0.8 | 0.57 | 1.0 |
| 6 | 2.92 | 2.92 | 0.85 | 0.70 | 1.0 |
| 5 | 3.46 | 3.46 | 1 | 0.83 | 1.0 |
| 4 | 4.10 | 4.10 | 1.5 | 0.98 | 1.0 |
| 3 | 4.90 | 4.90 | 1.7 | 1.18 | 1.0 |
| 2 | 5.90 | 5.90 | 1.9 | 1.42 | 1.0 |
| 1 | 7.42 | 7.42 | 2.5 | 1.78 | 1.0 |

5.2 Glossary of Terms used in E4 XLS and this Manual

Pipetting Terms

ADVANCED – Advanced Pipetting mode

AIR – air gap between two aspirations within the same pipetting cycle

ALIQUOTS - a sample dispensed from a larger volume; typically, refers to an individual sample of multi-dispense

ALIQUOT VOL – a list of available preset volumes

ASPIRATE - to pick up liquid into the pipette tip

ASP SPEED – aspirate speed

ASP/DISP – aspirate and dispense speeds

AUTO PACE - a programmable timed event for each multi-dispense aliquot

BLOWOUT - to run piston to the end of stroke – empty the tip of liquid

CYCLE COUNTER (abr. CC) -a setting which counts the total number of pipetting cycles

CYCLE SPEEDS – aspirate, dispense and mix speeds

DILUTE mode – to pick up two or more samples which may be separated by an air gap

DISPENSE - to release an amount of liquid

DISP SPEED – dispense speed

DONE - a single keystroke that saves setting and in some cases exits to prior screen

END VOLUMES – final selection from a list of preset volumes

FAST DISP VOL – in titrate mode, the first volume dispensed before fine increment dispensing

FIXED VOLUMES / FIXED VOL - to move a consistent set of fixed aspiration / dispensing steps without variation; same volume all the time

GLP mode - good laboratory practices, tracks the service and calibration of lab instruments

HOME - piston position after returning from blow out, ready to aspirate
 JOYSTICK BLOWOUT – option in MULTIDISPENSE MODE; OFF prevents BLOWOUT at the end of a multidispense cycle
 LEVEL I – within the main menu, the first set of available modes
 LEVEL II – within the main menu, the second set of available modes
 MANUAL mode - dynamic control of the motor to move the piston up or down using the joystick
 MIX - to move the pipette's piston up and down a number of times to mix sample
 MODE - a distinct subset of the operation of the pipette
 MULTI-DISPENSE / MULTI-DISP mode – to dispense multiple aliquots from one pick up volume
 BASIC mode – to pick up and dispense a known volume
 PIPETTE & MIX mode - to pick up and dispense a known volume into another sample, then mixing by rapidly aspirating & dispensing in and out of the tip
 PURESPEED MODE– allows E4 to run programs for functional pipette tips (e.g. Ion Exchange, ProA/ProG, and Ni-IMAC tips). See mt.com for more details
 REVERSE mode - method of picking up the blow out phase or second stop and dispensing only to the first stop, used for dense or viscous liquids
 SECOND STOP – hard stop at the end of blow out
 STEP – small incremental dispense steps
 TIP EJECT – a manual step, at the end of an operation, that removes the pipette's tip
 TITRATE mode – dispensing carefully measured amounts to a solution to cause a reaction
 VOLUME SEQUENCING - optional setting; ability to program up to 16 different aliquot volumes in a series
 SEQ VOLUMES – available set volumes selected from a list
 µL – a unit of measure, microliter
 mL - unit of measure, milliliter

General Terms

ADMIN MODE – allows administrator to LOCK pipette functions, HIDE menu entries, save USER PRESETS and reset all of the pipette settings back to FACTORY DEFAULTS
 ADMIN PASSCODE – a four digit code number, when set it protects the ADMIN MODE menu from unauthorized access
 ALARM – a warning that pipette service is due – SETUP has user settable time and cycle intervals
 ALARMS LOCK- ADMIN mode feature that prevents changes to ALARMS settings in SETUP mode
 AUTO OFF setting – duration after last usage before automatic power shutdown
 CALIBRATION - precision and accuracy verification of the instrument under controlled conditions
 CANCEL- a single keystroke that cancels an action and in some cases exits to prior screen
 CAROUSEL – method of displaying a menu in a continuous cyclic pattern
 CYCLES SNC SERVICE – number of cycles recorded since service
 DATE setting – user adjustable calendar time
 DATE FORMAT – available calendar formats in which the day, month & year are displayed:
 M/D/Y – month/day/year, Y/M/D – year/month/day, D/M/Y – day/month/year
 DATE/TIME LOCK- ADMIN mode feature that prevents changes to DATE and TIME settings in SETUP mode
 DEFAULT setting – preselected values, typically the most commonly used value
 DISPLAY BRIGHTNESS setting – the level of backlighting for the LCD screen
 DISPLAY TIMEOUT setting – the number of seconds before display dims, up to 120 seconds
 DONE - a single keystroke that saves setting and in some cases exits to prior screen
 FACTORY DEFAULTS – resets the pipette to factory default settings, and any ADMIN PASSCODE is deleted
 FIRMWARE VERSION – version number of the operating firmware
 GUI – graphical user interface – the displayed contents of the programmable features & setting
 UI – user interface – the total user experience combining the visual, audio & tactile features
 HELP mode – user guide with detailed operating information
 LANGUAGE – available languages that are programmed in the unit;
 EN English, ES Spanish, FR French, DE German, ZH Chinese ,JA Japanese
 LIFETIME CYCLES – total number of cycles since unit was manufactured
 LOCK ALL – All Modes and SETUP, except ADMIN MODE, will be locked so that settings cannot be changed. Use with PASSCODE to prevent any changes to any setting on the pipette.
 MAIN menu – the highest level in the programming sequence, also called TOP menu
 MANUF DATE – date unit was manufactured
 MINS - minutes
 MENU - a grouping of programmable features contained within a single screen
 MODE ACCESS – ADMIN mode function, allows a mode to be LOCKED, UNLOCKED or HIDDEN
 LOCKED – MODE SETTINGS cannot get changed
 UNLOCKED - MODE SETTINGS can get changed
 HIDDEN – The mode is not available in the CAROUSEL
 MODE LEVELS – user selectable level in the main menu for each mode
 MODE SETTINGS – includes speed, volume, and OPTION SETTINGS
 MODEL NUMBER – factory set volume range and tip style for each pipette
 NUMBER OF CYCLES – number of cycles since the last service
 NUMBER OF DAYS – number of days since the last service
 OFF - option turned off
 ON - option turned on

OPTIONS – additional settings available within a standard pipetting mode
 OPTION ICONS – icons on the lower left of the operating screen indicating OPTION status
 OWNER - the operator or owner of the instrument
 PASSCODE – see ADMIN PASSCODE
 MODE PRESET – allows you to save and restore mode settings to/from an SD card
 PRESET- see MODE PRESET or USER PRESET
 PRESET SELECTOR-displays the active Preset, or the number of saved Presets, and allows for Preset selection
 PREV – previous operating mode
 RESET - to cancel cycle by moving the piston to blowout
 REMOTE MODE – Allows communication with a PC for firmware upgrade and future applications SAVE - to enter into memory
 SECS – seconds, time measurement
 SETTING(S) – optional pipetting inputs – primarily volume and speed for a specific program
 SETUP - optional inputs for customization by the operator including name, sound level, backlight level, etc.
 SERIAL NUMBER – factory designated unique number for each pipette
 SERVICE LOG - Historical log of last 32 services performed on the pipette. Entered by technician. Not user-changeable
 SERVICE MODE – Provides unit service, identification and status related information
 SERVICE UNLOCK CODE (admin mode function) - 8 character code that allows you to overwrite the ADMIN MODE password protection with a temporary code, issued by an authorized Rainin pipette service center. The pipette SERIAL NUMBER is needed to generate this code. Available when an invalid PASSCODE is entered
 SOUND LEVEL setting - to turn ON or OFF the speaker, i.e., beep, during operation; when ON, the volume level can be set between 1, soft, and 10, loud
 SPEED setting – to decrease or increase the rate of flow in which sample is aspirated, dispensed or mixed
 SYSTEM ICONS – icons that indicate system status information such as volume level, SD card presence, password protection status and more
 SYSTEM ICON DISPLAY-area of the display on top right corner under the TIME and BATTERY ICON where SYSTEM ICONS are displayed
 USB universal serial bus – communications link; versions include micro & mini connectors
 USER PRESETS – allows you to save and restore all settings of a pipette, including MODE SETTINGS, SETUP and ADMIN settings, but does not save ADMIN PASSCODE
 TEXT EDITOR – a on-screen keyboard that allows text entry and editing with the joystick
 TIME – current time set in hours, minutes & seconds, displayed on operating screen, user adjustable
 TIME DISPLAY – available formats for displaying the time, user selected;
 NONE – no time display, 12 HOUR – 12 hour clock, no AM or PM , 24 HOUR – 24 hour clock
 VOLUME setting – setting for desired amount of liquid
 UNLOCK CODE-see SERVICE UNLOCK CODE

Power Management Terms

BACKLIGHT SETTING – a user setting for the amount of power driving the display backlight during normal use, adjustable for either ease of viewing or power conservation
 BACK-UP BATTERY (coin cell) – internal battery used to maintain vital operating parameters, i.e., real time clock
 BATTERY ICON – displays the state of the battery, amount of charge remaining until hibernation
 CHARGE INDICATOR – display of charging taking place (flashing battery icon)
 CHARGE CYCLE – time requirements for; 1) Charge Stand, 2) Micro-USB to PC, 3) Micro-USB to wall charger
 DIMINISHING CAPACITY – annual reduction in battery capacity
 INACTIVITY – period of time with no user input
 POWER DOWN – selectable, to turn power off
 POWER OFF MODE – will shut down the pipette and turns power off to preserve battery power
 SLEEP – automatic, display goes blank, power conservation mode after time out
 START – unit activated by pressing either soft keys, requires a single press
 TETHERED POWER OPERATION – to use the unit while attached with a USB cable to a wall charger
 TIME OUT FOR SLEEP – a user setting for duration before unit goes into sleep, up to 60 minutes
 WAKE UP – to restart full power mode from either sleep or deep sleep, by pressing either soft keys, requires a single press

5.3 Memory, Power and Settings Management

All user entered changes to settings on the E4 XLS, as well as Service Mode data, are saved in FLASH memory. They are therefore preserved in the event of battery failure or removal, with the exception of time and date (see paragraph below). If you wish to reset the pipette back to factory settings, open the battery door. Using a clean pipette tip, gently press and hold the reset button (see illustration below) for about 7 seconds. The unit will beep, a splash screen will appear, and a "Memory Clear" warning will be displayed. Press the left softkey to continue. This reset will NOT remove service data from the pipette, or presets, which are stored on the micro-SD card.

RESET BUTTON



Figure 40: Resetting E4 XLS

The real-time clock, which keeps track of time and date, requires a continuous source of power. If the main Li-Ion battery fails or is removed, and no external power source is applied (such as wall power or rapid charge stand) the clock runs off a back-up coin cell battery. This battery will keep the clock running for about 90-120 days. If the coin cell battery drains completely, a notice will remind you to reset the time and date after power is restored to the unit. A new coin cell battery will be needed to provide back-up power for the clock if desired. The E4 uses one standard CR1220 lithium ion coin cell battery, which can be purchased at any consumer electronic store. For more information, please contact Technical Support at 800-543-4030 in the US, or your METTLER TOLEDO office or distributor outside the US.

Specifications

These manufacturer's specifications should be used as guidelines when establishing your own performance specification.

| Model | Volume μL | Increment μL | Accuracy | | Precision | |
|----------------------|--------------|-----------------|------------------------|-----------------------------|------------------------|-----------------------------|
| | | | % | μL (±) | % | μL (<) |
| 10 μL | 1 | 0.01 | 2.5 / (4) ¹ | 0.025 / (0.04) ¹ | 1.2 / (3) ¹ | 0.012 / (0.03) ¹ |
| | 5 | | 1.5 | 0.075 | 0.6 | 0.030 |
| | 10 | | 1 | 0.100 | 0.4 | 0.040 |
| 20 μL | 2 | 0.02 | 7.5 | 0.15 | 2 | 0.04 |
| | 10 | | 1.5 | 0.15 | 0.5 | 0.05 |
| | 20 | | 1 | 0.20 | 0.3 | 0.06 |
| 50 μL ² | 5 | 0.05 | 3.5 | 0.18 | 1.5 | 0.075 |
| | 25 | | 1.2 | 0.30 | 0.4 | 0.100 |
| | 50 | | 0.8 | 0.40 | 0.2 | 0.100 |
| 100 μL | 10 | 0.1 | 3.5 | 0.35 | 1 | 0.10 |
| | 50 | | 0.8 | 0.40 | 0.24 | 0.12 |
| | 100 | | 0.8 | 0.80 | 0.15 | 0.15 |
| 200 μL | 20 | 0.2 | 2.5 | 0.5 | 1 | 0.20 |
| | 100 | | 0.8 | 0.8 | 0.25 | 0.25 |
| | 200 | | 0.8 | 1.6 | 0.15 | 0.30 |
| 300 μL | 30 | 0.2 | 2.5 | 0.75 | 1 | 0.300 |
| | 150 | | 0.8 | 1.20 | 0.25 | 0.375 |
| | 300 | | 0.8 | 2.40 | 0.15 | 0.450 |
| 1000 μL | 100 | 1 | 3 | 3 | 0.60 | 0.60 |
| | 500 | | 0.8 | 4 | 0.20 | 1 |
| | 1000 | | 0.8 | 8 | 0.15 | 1.5 |
| 1200 μL ² | 100 | 1 | 3.6 | 3.6 | 0.60 | 0.6 |
| | 600 | | 0.8 | 4.8 | 0.20 | 1.2 |
| | 1200 | | 0.8 | 9.6 | 0.15 | 1.8 |
| 2000 μL | 200 | 2 | 3 | 6 | 0.60 | 1.2 |
| | 1000 | | 0.8 | 8 | 0.20 | 2 |
| | 2000 | | 0.8 | 16 | 0.12 | 2.4 |
| 5000 μL | 500 | 5 | 2.4 | 12 | 0.60 | 3 |
| | 2500 | | 0.6 | 15 | 0.20 | 5 |
| | 5000 | | 0.6 | 30 | 0.16 | 8 |
| 10 mL | 1 mL | 10 | 5 | 50 | 0.60 | 6 |
| | 5 mL | | 1 | 50 | 0.20 | 10 |
| | 10 mL | | 0.6 | 60 | 0.16 | 16 |
| 20 mL | 2 mL | 20 | 5 | 100 | 0.60 | 12 |
| | 10 mL | | 1 | 100 | 0.20 | 20 |
| | 20 mL | | 0.6 | 120 | 0.16 | 32 |

Specifications are subject to change without notice.

¹ Multichannel.

² Multichannel models only in these volume ranges.

EC Declaration of Conformity according to ISO 17050

Manufacturer's Name: Mettler-Toledo Rainin, LLC.

Manufacturer's Address: 7500 Edgewater Drive, Oakland, CA, 94621, USA

declares that the following product:

Product Name E4 XLS Electronic Pipette

Model Number: E4 XLS

Product Options: E4-WPS Wall Power Supply

E4-RCS Rapid Charge Stand

E4-RCSWPS Wall Power Supply for Rapid Charge Stand

conforms to the following Product Specifications:

Safety: IEC/EN 61010-1:2010

Emissions Testing: EN 61326-1:2014

Testing performed to: Class A Limits (commercial/industrial environment)

Radiated Emissions: 30MHz-1GHz

Conducted Emissions Power ports

Immunity Testing: EN 61326-1:2014

EN61000-4-2 Electrostatic Discharge 4kV Air & 4kV Contact

EN61000-4-3 Radiated Immunity: 80MHz-1000MHz & 1400MHz-2700MHz)

EN61000-4-4 Electrical Fast Transients

EN61000-4-5 Surge: Power Ports

EN61000-4-6 Conducted Immunity: .15MHz-80MHz

EN61000-4-11 Voltage Dips and Interrupts

Herewith declares that the product is in conformity with the provisions of the following EC directives (incl. all applicable amendments):

2014/35/EU Low voltage (LVD)

2014/30/EU Electromagnetic compatibility (EMC)

Supplementary Information:

Responsible Signatory: David Greenwood, Head of Quality

Date: August, 2016

This Declaration of Conformity applies only to products which have the CE mark attached.

WARNING:

This equipment generates and uses radio frequency energy and if not installed and used properly, i.e. in strict accordance with the instruction manual, may cause harmful interference to radio communications. It has been tested and found to comply with the limits for a Class A computing device pursuant to Subpart B of Part 15 of FCC rules, which are designed to provide reasonable protection against such interference when operated in a commercial environment. Operation of this equipment in a residential area is likely to cause interference, in which case the user at his own expense will be required to take whatever measures may be required to correct the interference.

Disposal



In conformance with the European Directive 2012/19/EU on Waste Electrical and Electronic Equipment (WEEE) this device may not be disposed of in domestic waste. This also applies to countries outside the EU, per their specific requirements. Please dispose of this product in accordance with local regulations at the collecting point specified for electrical and electronic equipment.

If you have any questions, please contact the responsible authority or the distributor from which you purchased this device.

Should this device be passed on to other parties (for private or professional use), the content of this regulation must also be related.

Thank you for your contribution to environmental protection.



RoHS Regulation # 2011/65/EU:

Rainin and METTLER TOLEDO fulfil requirements under RoHS Regulation # 2011/65/EU.

E4 XLS products and accessories comply with the above mentioned RoHS Regulation.

www.mt.com/rainin

For more information

Mettler-Toledo Rainin, LLC

7500 Edgewater Drive
Oakland, CA 94621

Sales 800-472-4646 or +1 510 564 1600

Service 800-543-4030 or +1 510 564 1600

Subject to technical changes

© 2016 Mettler-Toledo Rainin, LLC

Printed in USA. Part Number 30370118 Version A