

## Operating Instructions

### YTM15MA

Heating Adjustment Set

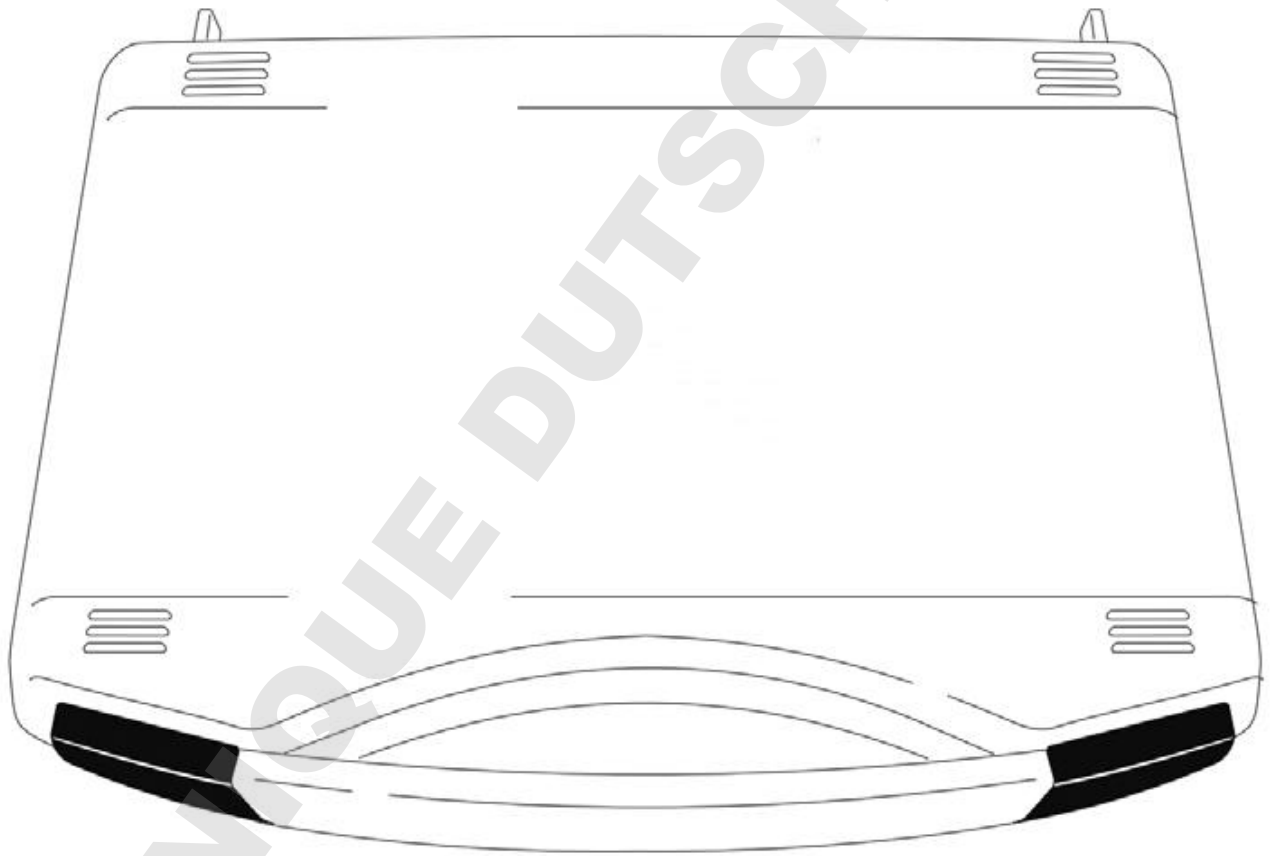

**DOMINIQUE DUTSCHER SAS**

# Contents

<b>1 About These Instructions</b> .....	4	<b>5 Cleaning and Maintenance</b> .....	27
1.1 Scope .....	4	5.1 Changing the Battery.....	27
1.2 Other Applicable Documents...	4	5.2 Maintenance.....	27
1.3 Symbols Used .....	4	<b>6 Waste Disposal Policy</b> .....	27
1.3.1 Warnings.....	4	6.1 General Instructions.....	27
1.3.2 Other Symbols.....	5	6.2 Waste Disposal Policy.....	28
<b>2 Safety Instructions</b> .....	5	<b>7 Sartorius Service</b> .....	28
2.1 Intended Use.....	5	<b>8 Factory Calibration Certificate</b>	
2.2 Personal Protective Equipment..	5	<b>(Sample)</b> .....	29
2.3 Hot Surfaces .....	6		
<b>3 Installation</b> .....	7		
3.1 Equipment Supplied .....	7		
3.2 Inserting the Battery .....	8		
<b>4 Operation</b> .....	8		
4.1 Notes on Calibrating the			
Moisture Analyzer.....	8		
4.2 Transporting and Removing			
the Adjustment Disk.....	9		
4.3 Need for Calibration/Adjusting			
the Heating Module .....	11		
4.4 Calibrate Heating Module			
(MA37   MA160) .....	13		
4.5 Calibrate/Adjust Heating			
Module (MA37   MA160) .....	17		
4.6 Single-Point Temperature			
Adjustment (MA35) .....	22		

# 1 About These Instructions

## 1.1 Scope

These instructions apply to the following product:

Product	Model
Heating Adjustment Set	YTM15MA

## 1.2 Other Applicable Documents

- ▶ In addition to these instructions, please observe the following documents:
  - Operating Instructions for the Moisture Analyzer (MA35 | MA37 | MA160)
  - Instructions for the temperature measuring instrument

## 1.3 Symbols Used

### 1.3.1 Warnings

---

#### CAUTION

Denotes a hazard that may result in moderate or minor injury if it is **not** avoided.

---

#### NOTICE

Denotes a danger that can result in property damage if the risk is **not** avoided.

---

### 1.3.2 Other Symbols

- ▶ Required action: Describes actions which must be carried out.
- ▷ Result: Describes the result of the activities carried out.
- [ ] Text inside brackets refers to control and display items.

### Figures on the Operating Display

Depending on the device configuration, the figures on the operating display of the device may differ from those described in these instructions.

## 2 Safety Instructions

### 2.1 Intended Use

The product is used for the calibration and adjustment of the heating module of a moisture analyzer (MA35 | MA37 | MA160). Do **not** use the product in potentially explosive environments.

Any further use beyond this is considered improper and is prohibited. These instructions are part of the product. The product is intended exclusively for use in accordance with these instructions.

### 2.2 Personal Protective Equipment

Personal protective equipment protects against risks arising from handling the product.

- ▶ Wear appropriate personal protective equipment.
- ▶ Also follow the instructions posted in the work area pertaining to personal protective equipment.

## 2.3 Hot Surfaces

During operation, parts of the device can heat up, thereby making their surfaces hot. There is a danger of burns to the body parts that touch these surfaces.

- ▶ Avoid contact with hot surfaces.
- ▶ Before working with the device: Allow the heating element and device equipment to cool.
- ▶ Do not insert the adjustment disk immediately after drying.
- ▶ Always use the removal tool to transport the adjustment disk or remove it from the moisture analyzer after a measurement.
- ▶ Allow the adjustment disk to cool on a clean, temperature-resistant pad before or after completion of a measurement.
- ▶ After cooling, place the adjustment disk back into the carrying case and store it in a dust-free and protected location.
- ▶ Wear personal protective equipment.

## 3 Installation

### 3.1 Equipment Supplied

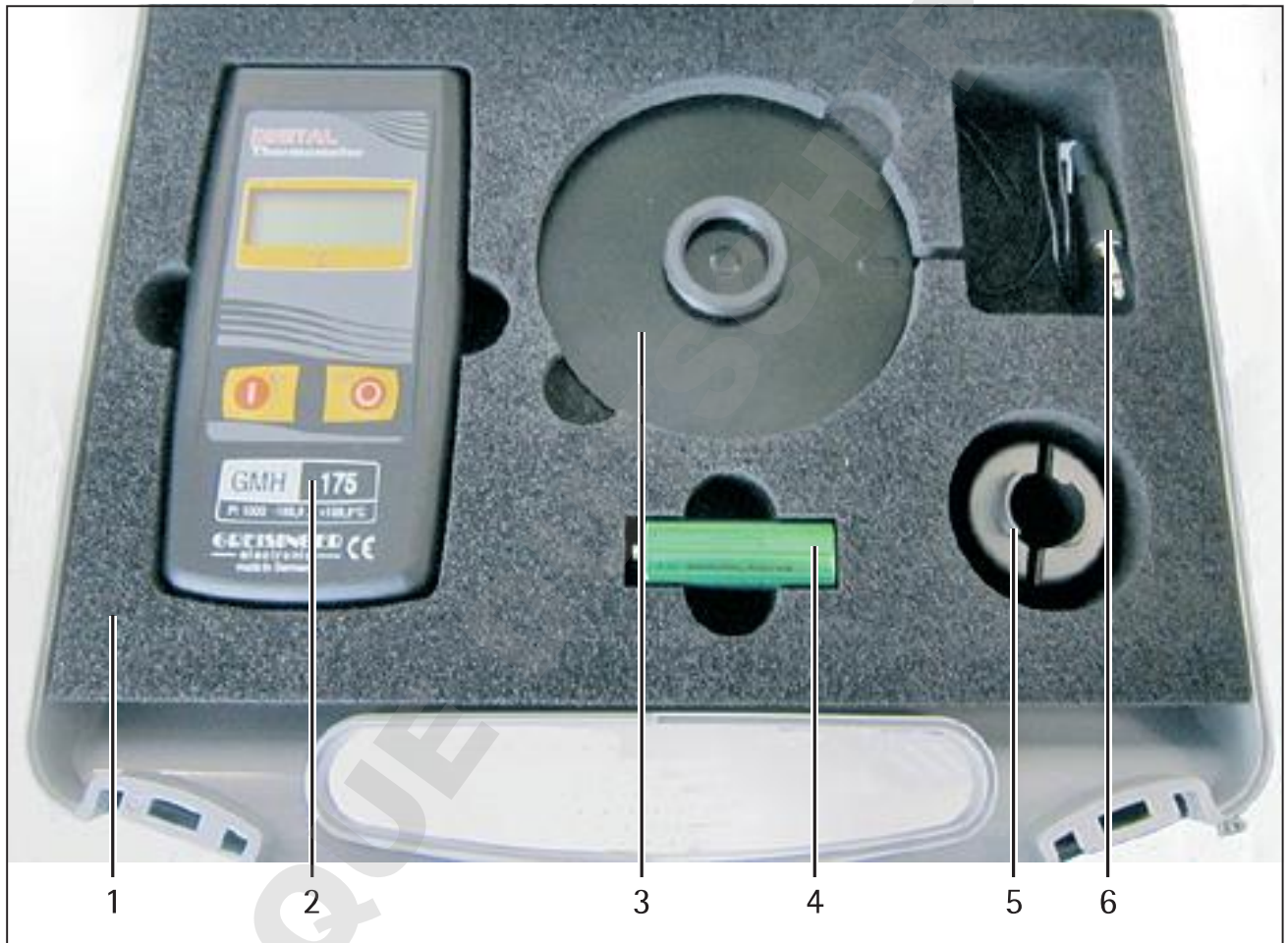

Fig. 3-1: Equipment Supplied

Pos.	Product	Quantity
1	Carrying case	1
2	Temperature measuring instrument	1
3	Adjustment disk	1
4	Battery	1
5	Disk holder (removal tool)	1

Pos.	Product	Quantity
6	Measurement cable (permanently attached to the adjustment disk)	1
Not illustrated	Instructions for the Heating Adjustment Set	
Not illustrated	Instructions for the Temperature Measuring Instrument	
Not illustrated	Factory calibration certificate with serial number (ref. ID no.)	

### 3.2 Inserting the Battery

- ▶ Insert the battery into the temperature measuring instrument (to do this, refer to the Instructions for the Temperature Measuring Instrument).

## 4 Operation

### 4.1 Notes on Calibrating the Moisture Analyzer

When calibrating the moisture analyzer using the heating adjustment set, there is an examination of whether the moisture analyzer is adjusted to the ambient conditions at the place of use. A basic heating adjustment has already been carried out at the factory. This adjustment is valid for many installation sites under laboratory conditions.

However, if you have particular ambient conditions, e.g. strong direct sunlight or operation in an exhaust, then an inspection will be necessary.

The adjustment disk has a special coating, which absorbs almost all heat radiation. This ensures that your measurements are reliably adjustable to all operating sites.

If calibration is carried out, then this must be calibrated in the ambient conditions present. E.g.: If the moisture analyzer is operated in a room with exhaust, then the moisture analyzer must also be calibrated at this place of use.



The following conditions should be taken into account when calibrating the moisture analyzer:

- Carry out calibration in a temperate area. The room temperature should be 20°C.
- Carry out calibration in a clean measurement location.
- Use a stable and level surface (table).
- Drafts, e.g. from open doors/windows, should be avoided.

If required: Shield the device.

- The frequent movement of persons in front of the device should be avoided (unstable conditions).
- Avoid direct sunlight.
- Avoid gases or dusts.
- Establish a safety distance in the direct vicinity of the device. At least 20 cm on all sides and at least 1 m above the device.

## 4.2 Transporting and Removing the Adjustment Disk

---

### CAUTION

#### **Danger of burns due to hot adjustment disk!**

- ▶ Always use the disk holder (removal tool) to transport the adjustment disk or remove it from the moisture analyzer after calibration.
  - ▶ Allow the adjustment disk to cool on a clean, temperature-resistant pad before or after completion of a measurement.
  - ▶ Only place the adjustment disk back into the carrying case after cooling.
  - ▶ Wear personal protective equipment.
-

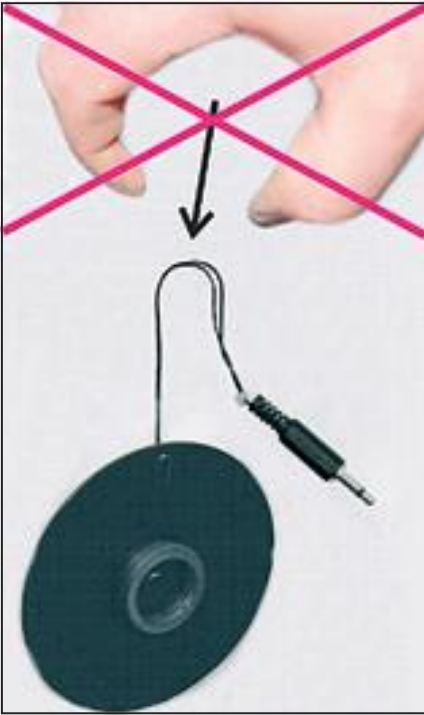

## NOTICE

### Danger of damage to the adjustment disk!

The adjustment disk is calibrated according to a factory-internal test procedure. If the adjustment disk is damaged, it will lose its measurement accuracy.

Observe the following notes in order to maintain the measurement accuracy:

- ▶ Do **not** remove or transport the adjustment disk using a sharp-edged tool (e.g.: pliers or tweezers).
- ▶ Do not pull the adjustment disk out of the device using the measurement cables.
- ▶ Do not transport the adjustment disk by holding it by the measurement cables.
- ▶ Keep the adjustment disk clean. Clean any soiling using water or a soft, lint-free cloth.
- ▶ Clean any coarse soiling using a brush.
- ▶ Do not use cleaning agents, e.g. solvents or similar agents.
- ▶ Do not scratch the adjustment disk.
- ▶ Do not touch the adjustment disk with oily or greasy fingers.



### Remove the adjustment disk using the disk holder

- ▶ Squeeze the disk holder on the underside and place centrally on the adjustment disk.
- ▶ Release the disk holder.
- ▷ The disk holder is connected with the adjustment disk.
- ▶ Transport the adjustment disk.

### Putting the adjustment disk down

- ▶ Transport the adjustment disk to the moisture analyzer or the shelf.
- ▶ Squeeze the disk holder underneath.
- ▷ The adjustment disk is released from the disk holder.

## 4.3 Need for Calibration/Adjusting the Heating Module

In order to check the device, a performance test can first be carried out (for performance test, see operating instructions for the moisture analyzer). If this test is passed, the function of the moisture analyzer is guaranteed.

If the test produces two negative results in a row, then as a next step the weighing system of the moisture analyzer must first be checked (for calibration, see operating instructions for the moisture analyzer).

If the performance test is failed again after checking the weighing system, the heating module must be calibrated (for this, refer to the next section). If necessary, the heating module must be adjusted.

---

### NOTICE

An adjustment of the heating module is an essential procedure. Therefore, a precise analysis must be performed before the calibration as any possible incorrect calibration can have negative effects on the measurement results.

---

After the calibration/adjustment of the heating module, carry out another performance test. If the performance test is again failed after calibration/adjustment of the heating module, please contact Sartorius Service.

Refer also to the following flow diagram for the procedure.

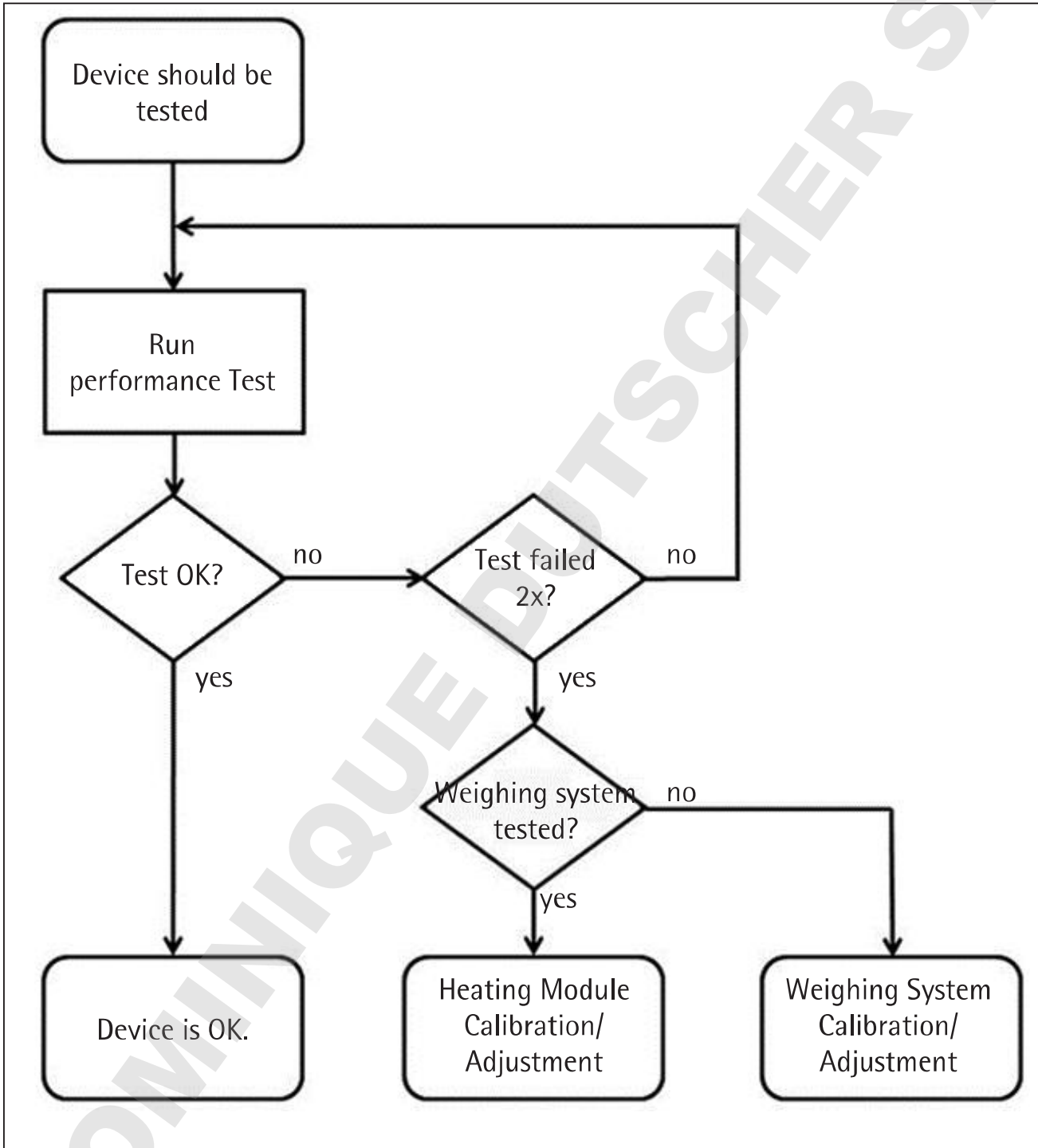

Fig. 3-2: Process of testing the heating module MA37 | MA160

Reasons for an incorrect measurement may be:

- Non-compliance regarding ambient conditions.
- Intense direct sunlight.
- Strong draft.
- "ReproEasy Pad" was not used correctly during the performance test. E.g. the protective film was not removed from the "ReproEasy pad" or the incorrect side of the "ReproEasy pad" was placed on the pan.
- Weighing system is defective.

#### **4.4 Calibrate Heating Module (MA37 | MA160)**

Calibration of the heating module involves calibration at a fixed temperature setting. The result is saved in the calibration report.

Carry out the calibration at the subsequent installation site in order to ensure precise calibration of the heating module. The calibration takes at least 50 minutes.

##### **System Requirements**

- At least 30 minutes have passed since the last application measurement.
- The device has cooled down with the hood open.

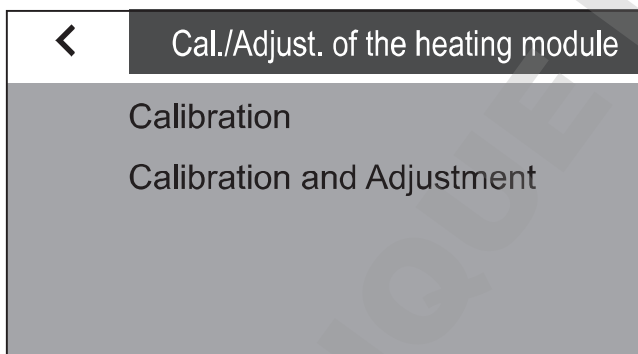
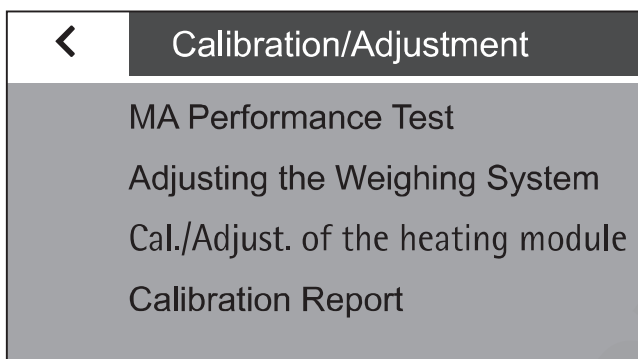
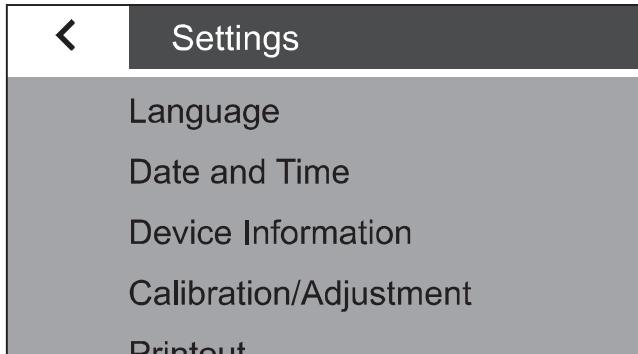

### Procedure

- ▶ Call up the setup menu [Settings].
- ▶ Press the [Calibration/Adjustment] key.
  
- ▶ Press the [Cal./Adjust. of the Heating Module] key.
  
- ▶ Press the [Calibration] key.
  
  
- ▶ Open the hood.
- ▶ Remove the sample pan if necessary.

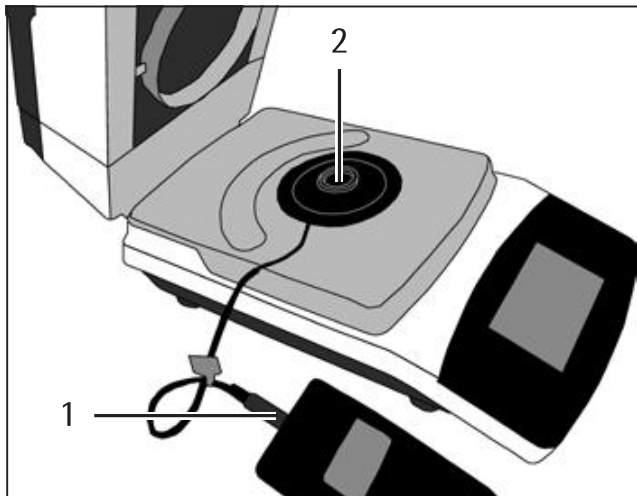

- ▶ Place the connector (1) of the measurement cable into the temperature measuring device.
- ▶ **NOTICE** Observe the information in Chapter 4.2, Page 9. Use the disk holder to position the adjustment disk (2) on the pan retainer.



### Calibrating the heating

Heating temperature 140°C  
Remove pan,  
position adjustment disk. Close the  
hood and press START.



**START**

- ▶ Close the hood.
- ▶ Press the [START] key.
- ▶ The heating module will heat up.



02:08

### Calibrating the heating

Heating temperature 140°C  
Heating-up phase: 45:00 min



The device requires a heating-up time of 45 minutes.

- ▶ Wait for the end of the heating-up phase.
- ▶ The time elapsed is shown at the top of the display.



42:23

### Calibrating the heating

Heating temperature 140°C  
Stabilization phase: 14%



The heating-up phase is followed by a stabilization phase (specification in percent).

- ▶ Wait for the end of the stabilization phase.
- ▶ After the end of the stabilization phase, the device emits a beep.

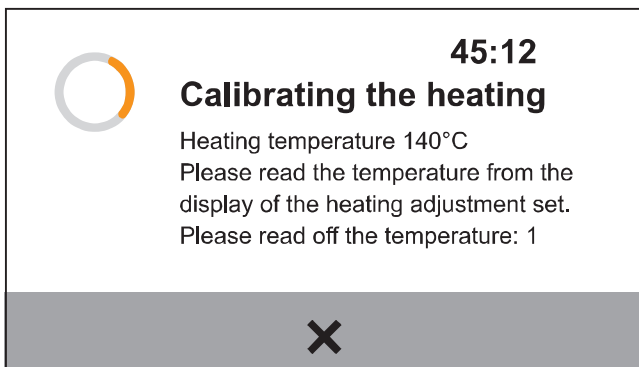

- ▶ Switch on the temperature measuring instrument.

After the heating-up and stabilization phase, a total of six temperature values must be read off and noted down.

- ▶ Read and note down the first temperature value.

After a minute, there is another beep signaling that it is time to read off the next temperature value.

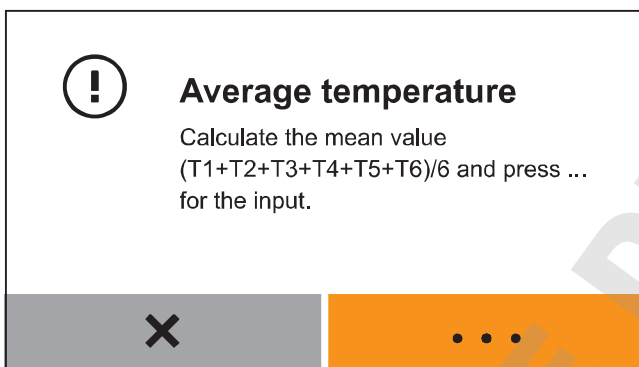

- ▶ Calculate the average temperature (mean value).

- ▶ Press the [...] key.

- ▶ Enter the calculated average temperature in the following input screen.

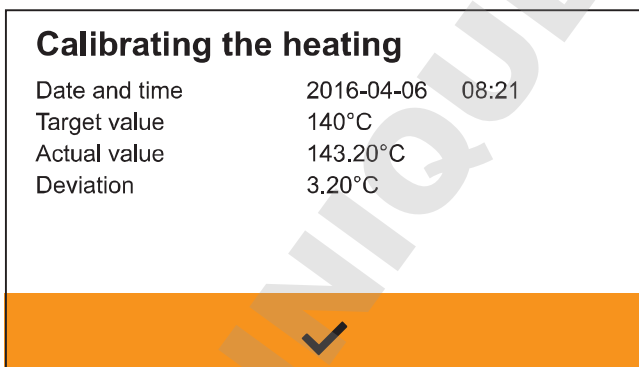

- ▶ The result of the calibration is displayed.

The result of the calibration can subsequently be called up at any time via the menu Settings -> Calibration/Adjustment -> Calibration Report -> Heating Calibration.

- ▶ Switch off the temperature measuring instrument.



- ▶ Remove the measurement cable connector from the temperature measuring device.
- ▶ Allow the device to cool down.
- ▶ Open the hood.
- ▶ **⚠ CAUTION** Danger of injury due to hot surfaces! Observe the information in Chapter 4.2, Page 9. Remove the adjustment disk from the pan retainer using the disk holder (removal tool) and leave to cool on a temperature-resistant pad.
- ▷ The calibration of the heating module is now complete.

#### 4.5 Calibrate/Adjust Heating Module (MA37 | MA160)

Calibration and adjustment of the heating module involves calibration on two fixed temperature settings. The heating module can be adjusted directly afterwards depending on the result of the calibration. The result is saved in the calibration report.

Carry out the calibration at the subsequent installation site in order to ensure precise calibration of the heating module. The calibration takes around 100 minutes.

##### System Requirements

- At least 30 minutes have passed since the last application measurement.
- The device has cooled down with the hood open.

##### Procedure

- ▶ Call up the setup menu [Settings].

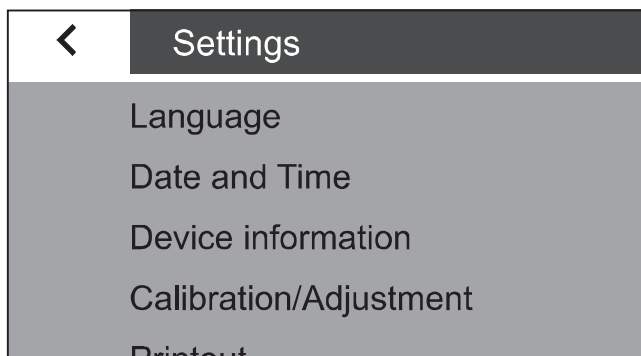

- ▶ Press the [Calibration/Adjustment] key.

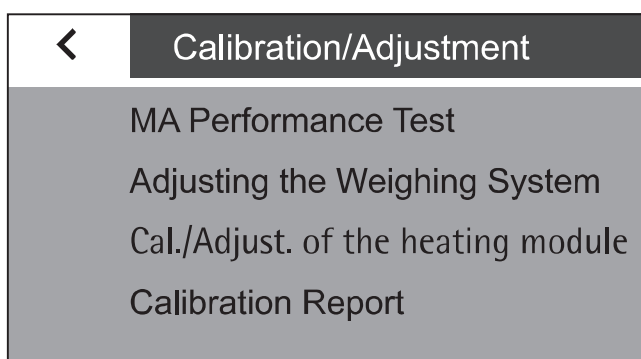

- ▶ Press the [Cal./Adjust. of the Heating Module] key.

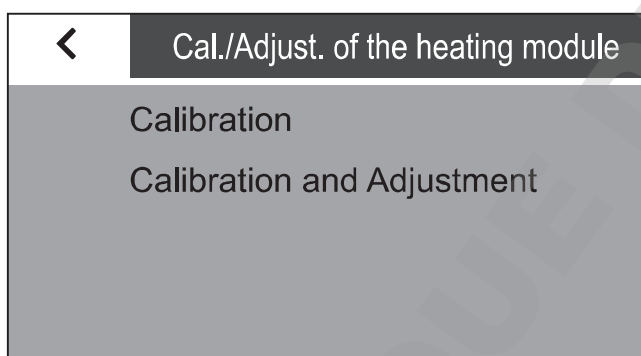

- ▶ Press the [Calibration and Adjustment] key.

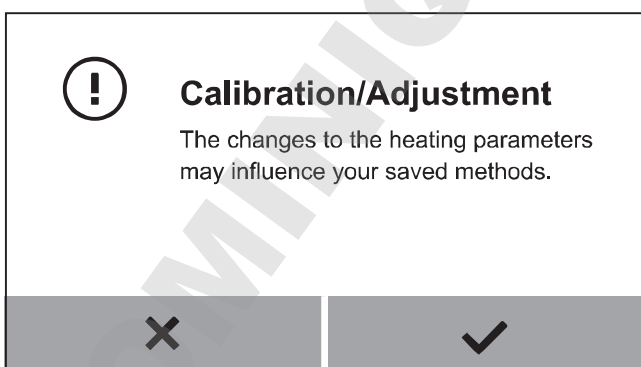

- ▶ Confirm the query or cancel the process.

- ▶ Open the hood.
- ▶ Remove the sample pan if necessary.

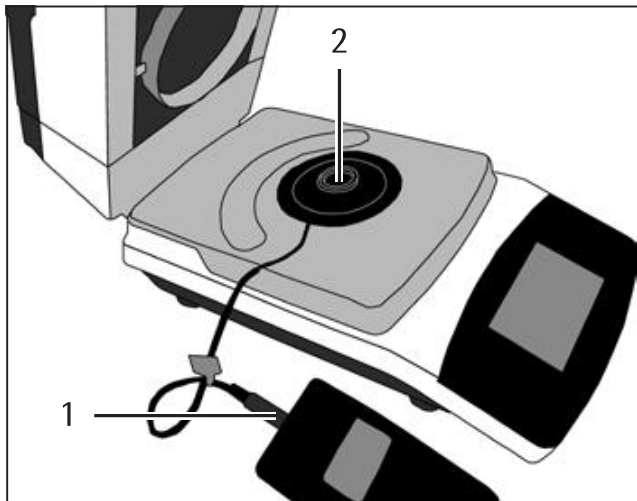

- ▶ Place the connector (1) of the measurement cable into the temperature measuring device.
- ▶ **NOTICE** Observe the information in Chapter 4.2, Page 9. Use the disk holder to position the adjustment disk (2) on the pan retainer.

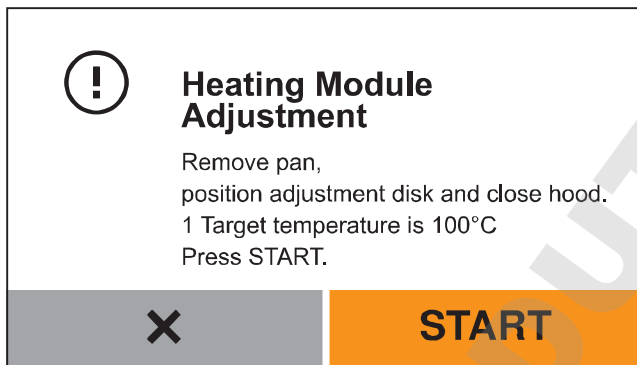

- ▶ Close the hood.
- ▶ Press the [START] key.
- ▷ The heating module will heat up.

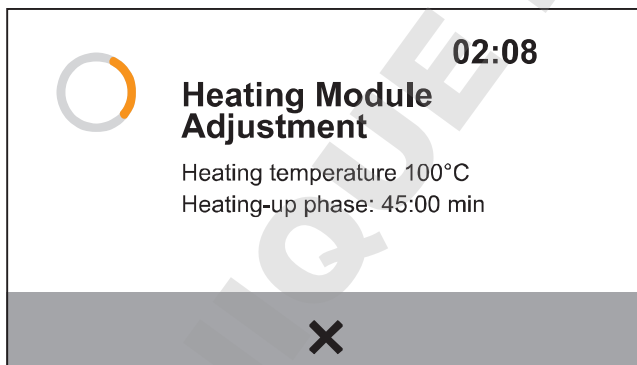

The device requires a heating-up time of 45 minutes.

- ▶ Wait for the end of the heating-up phase.
- ▷ The time elapsed is shown at the top of the display.

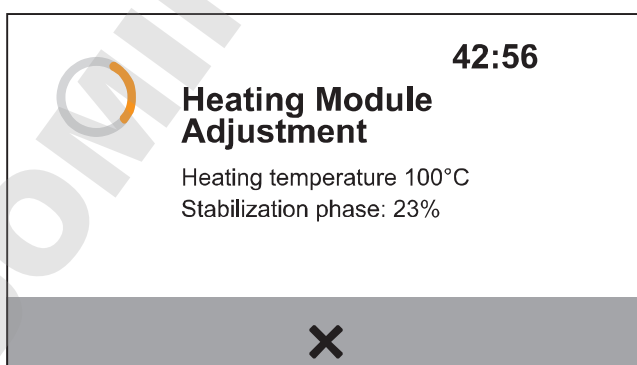

The heating-up phase is followed by a stabilization phase (specification in percent).

- ▶ Wait for the end of the stabilization phase.
- ▷ After the end of the stabilization phase, the device emits a beep.

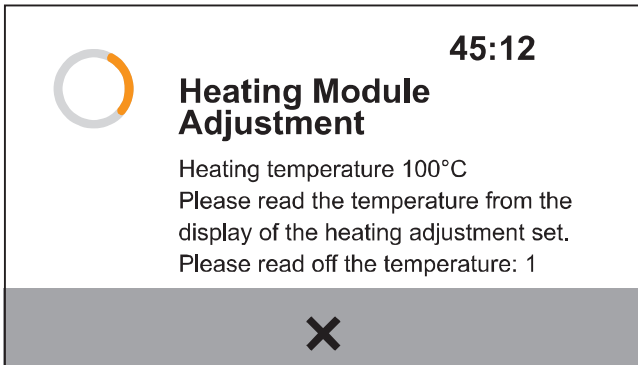

- ▶ Switch on the temperature measuring instrument.
- After the heating-up and stabilization phase, a total of six temperature values must be read off and noted down.
- ▶ Read and note down the first temperature value.

After a minute, there is another beep signaling that it is time to read off the next temperature value.

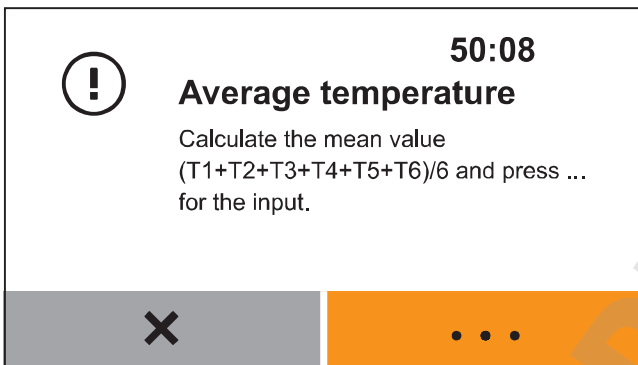

- ▶ Calculate the average temperature (mean value).
- ▶ Press the [...] key.
- ▶ Enter the average temperature in the following input screen.

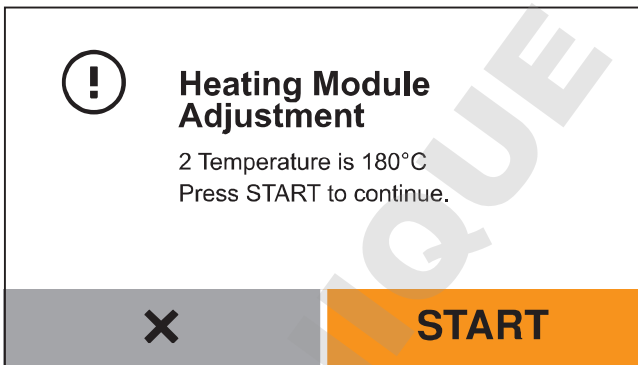

- ▶ Repeat the process with the second temperature.
- ▶ Follow the instructions on the operating display.

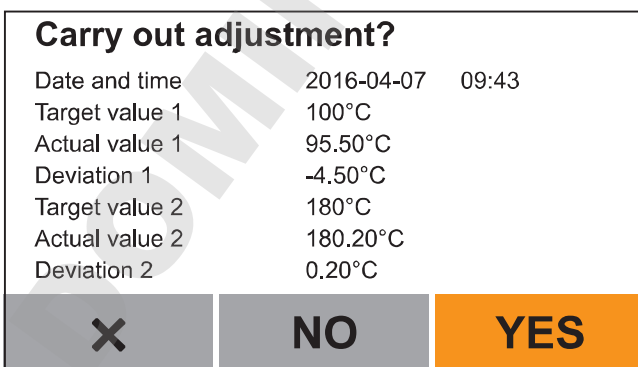

- ▶ Assess the results and perform an adjustment if necessary.

Calibration Finished		
Date and time	2016-04-07	09:43
Adjustment	Yes	
Target value 1	100°C	
Actual value 1	95.50°C	
Deviation 1	-4.50°C	
Target value 2	180°C	
Actual value 2	180.20°C	

✓

- ▷ If an adjustment has been performed: The result of the adjustment is displayed.

The result of the calibration and adjustment can be called up later at any time via the menu Settings -> Calibration/Adjustment -> Calibration Report -> Adjustment of the Heating or Heating 2-point Cal.

- ▶ Switch off the temperature measuring instrument.
- ▶ Remove the measurement cable connector from the temperature measuring device.
- ▶ Allow the device to cool down.
- ▶ Open the hood.
- ▶ **⚠ CAUTION** Danger of injury due to hot surfaces! Observe the information in Chapter 4.2, Page 9. Remove the adjustment disk from the pan retainer using the disk holder (removal tool) and leave to cool on a temperature-resistant pad.
- ▷ The calibration and adjustment of the heating module is now complete.

## 4.6 Single-Point Temperature Adjustment (MA35)

Carry out the calibration at the subsequent installation site in order to ensure precise calibration of the heating module. The calibration takes around 85 minutes.

### System Requirements

- At least 30 minutes have passed since the last application measurement.
- The device has cooled down with the hood open.

The following procedure corresponds to a fixed, uniform process between heating up, cooling down, measuring and adjusting, each under the same general conditions.

These constant conditions are required so that the temperature measurements can be compared.

### Procedure

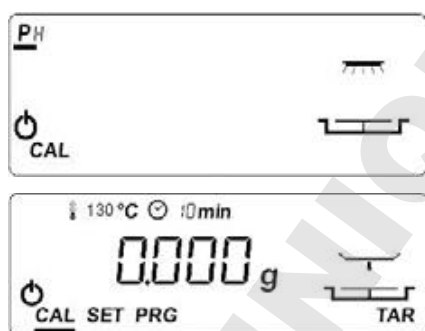

- ▶ Switch on the device.
- ▶ Set the following drying parameters:
  - Drying temperature: As set in the method.
  - Remaining parameters: Any.
- ▶ Select the "Calibrate" function using the cursor keys.
- ▶ Confirm "CAL" (display) with the "ENTER" key.
- ▶ Select the "PH" function (heating calibration) with the cursor keys, and confirm with [ENTER].
- ▷ "TAR" appears on the display.
- ▶ To tare the device: Press the [Enter] key.

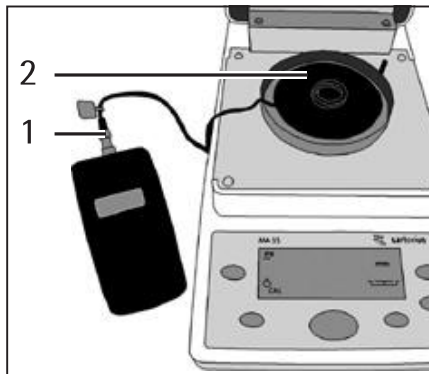

- ▶ Place the connector (1) of the measurement cable into the temperature measuring device.
- ▶ **NOTICE** Observe the information in Chapter 4.2, Page 9. Use the disk holder to position the adjustment disk (2) on the pan retainer.
- ▶ Close the hood.
- ▷ The measurement starts with the following sequence:
  - 0.0 to 49.9 minutes: Display "CAL H1".
  - 50.0 to 69.9 minutes: Display "CAL H2".
  - 70.0 to 84.9 minutes: Display "CAL H3".
  - 85.0 to 99.9 minutes: Display "+ x.x,".
  - Output display "+ 0.0." "Beeps" 5x every 10 sec. until one of the two "+/- cursor keys" is confirmed for the first time.



- ▶ If the temperature discrepancy is within the tolerance (after 85 minutes): Press [CF] to exit the program.

## NOTICE

It is essential to observe the conversion table on page 25.



- ▶ If the temperature discrepancy is outside of the tolerance (between 85 and 100 minutes): Correct the temperature using the cursor keys [+/-].
- ▶ Enter the correction values: Positive values for a temperature that is too low, negative values for a temperature that is too high.
- ▶ To confirm the correction: Hold down the [ENTER] key.
- ▷ A printout is generated.

If no correction entry with a confirmation is made before 100 minutes, the calibration cancels automatically with "Err C."

The permitted adjustment range depends on the selected drying temperature.

### **Some Adjustment Temperatures (Selection) and the Permitted Adjustment Range**

Adjustment temperature	Adjustment range
50°C	+ 5.5° / -7.5°C
100°C	+ 9.5° / -12.5°C
150°C	+13.5° / -18°C

### **Conversion Table, Only Use in Conjunction with an MA35 Moisture Analyzer**

The table is required to establish comparability to the old measurement disk technology of the YTM01MA: The coating of the adjustment disk from the YTM15MA heating adjustment set absorbs considerably more heat than the old measurement disk technology of the YTM01MA. Use the following table in order to ensure the compatibility of the MA35 temperature scale.



Temperature on measuring device [°C]	Converted temperature for MA35 [°C]	Temperature on measuring device [°C]	Converted temperature for MA35 [°C]	Temperature on measuring device [°C]	Converted temperature for MA35 [°C]
50	39.50	78	61.62	106	83.74
51	40.29	79	62.41	107	84.53
52	41.08	80	63.20	108	85.32
53	41.87	81	63.99	109	86.11
54	42.66	82	64.78	110	86.90
55	43.45	83	65.57	111	87.69
56	44.24	84	66.36	112	88.48
57	45.03	85	67.15	113	89.27
58	45.82	86	67.94	114	90.06
59	46.61	87	68.73	115	90.85
60	47.40	88	69.52	116	91.64
61	48.19	89	70.31	117	92.43
62	48.98	90	71.10	118	93.22
63	49.77	91	71.89	119	94.01
64	50.56	92	72.68	120	94.80
65	51.35	93	73.47	121	95.59
66	52.14	94	74.26	122	96.38
67	52.93	95	75.05	123	97.17
68	53.72	96	75.84	124	97.96
69	54.51	97	76.63	125	98.75
70	55.30	98	77.42	126	99.54
71	56.09	99	78.21	127	100.33
72	56.88	100	79.00	127	100.33
73	57.67	101	79.79	128	101.12
74	58.46	102	80.58	129	101.91
75	59.25	103	81.37	130	102.70
76	60.04	104	82.16	131	103.49
77	60.83	105	82.95	132	104.28

Temperature on measuring device [°C]	Converted temperature for MA35 [°C]	Temperature on measuring device [°C]	Converted temperature for MA35 [°C]	Temperature on measuring device [°C]	Converted temperature for MA35 [°C]
133	105.07	160	126.40	188	148.52
134	105.86	161	127.19	189	149.31
135	106.65	162	127.98	190	150.10
136	107.44	163	128.77	191	150.89
137	108.23	164	129.56	192	151.68
138	109.02	165	130.35	193	152.47
139	109.81	166	131.14	194	153.26
140	110.60	167	131.93	195	154.05
141	111.39	168	132.72	196	154.84
142	112.18	169	133.51	197	155.63
143	112.97	170	134.30	198	156.42
144	113.76	171	135.09	199	157.21
145	114.55	172	135.88	200	158.00
146	115.34	173	136.67		
147	116.13	174	137.46		
148	116.92	175	138.25		
149	117.71	176	139.04		
150	118.50	177	139.83		
151	119.29	178	140.62		
152	120.08	179	141.41		
153	120.87	180	142.20		
154	212.66	181	142.99		
155	122.45	182	143.78		
155	122.45	183	144.57		
156	123.24	184	145.36		
157	124.03	185	146.15		
158	124.82	186	146.94		
159	125.61	187	147.73		

## 5 Cleaning and Maintenance

### 5.1 Changing the Battery

If the battery installed in the temperature measuring instrument is discharged, then it must be replaced.

If "BAT" appears on the display after the temperature measuring instrument is switched on, the battery is discharged. For further information on replacing the battery, see the operating instructions for the temperature measuring instrument.

### 5.2 Maintenance

The adjustment disk should be inspected annually if used frequently (> 1x/week). Send the adjustment disk with complete heating adjustment set to Sartorius Service.

## 6 Waste Disposal Policy

### 6.1 General Instructions



The equipment, including accessories and empty non-rechargeable and rechargeable batteries, does not belong in your regular household waste; this equipment is manufactured from high-grade materials which can be recycled and reused. European Directive 2012/19/EC on Waste Electrical and Electronic Equipment (WEEE) requires that electrical and electronic equipment be collected and disposed of separately from other unsorted municipal waste, with the aim of recycling it. The crossed-out waste bin symbol indicates that separate collection is required.

In Germany and several other countries, Sartorius itself assumes responsibility for the return and legally compliant disposal of its electronic and electrical products. These products may not be placed with household waste or be brought to collection centers run by local public disposal operations – not even by small commercial operators. Contact Sartorius Service for this purpose.

In countries that are not members of the European Economic Area (EEA) or where no Sartorius subsidiaries or dealerships are located, please contact your local authorities or a commercial disposal operator.

## 6.2 Waste Disposal Policy

### Device

- ▶ Remove the batteries and dispose of the device in accordance with local government regulations.
- ▶ For detailed information and service addresses for disposing of the device, visit our website ([www.sartorius.com](http://www.sartorius.com)).

### Non-rechargeable and Rechargeable Batteries

- In Europe, old non-rechargeable and rechargeable batteries can be disposed of for free at special collection points.
- In Germany, dispose of old non-rechargeable and rechargeable batteries for free using the GRS system: [www.grs-batterien.de/start.html](http://www.grs-batterien.de/start.html)

## 7 Sartorius Service

Sartorius Service is available to answer queries about the device. For information on service addresses, the services themselves and the local contact, visit our website ([www.sartorius.com](http://www.sartorius.com)).

# 8 Factory Calibration Certificate (Sample)

## Werkskalibrierzertifikat Factory Calibration Certificate

Messobjekt: Heizungsabgleichset (YTM15MA)  
Test object: Heating Adjustment Set (YTM15MA)

Seriennummer: 1234567890

Serial number:

Prüfmittel-Nr:

No of test equipment:

Zertifikatsnummer: 2015/ 00

Certificate number:

Messmethode: Temperatur-Vergleichsmessung  
Test method: Comparative temperature measurement

Messpunkte: 80°C, 140°C, 200°C  
Measuring points:

Referenz-Objekt	Meßobjekt	Anzeige-korrektur	Meßunsicherheit	Raumtemperatur
Reference object	Test object	Display correction	±	± 0,5 °C
[°C]	[°C]	[°C]	[°C]	[°C]
80,0	81,0	-1,0	0,7	23,4
141,0	139,0	2,0	0,7	22,1
201,0	199,0	2,0	0,7	22,7

Verwendete Prüfmittel:

Referenzmessscheibe für Temperaturabgleich, Prüfmittel-Nr: TEM0571

Temperaturmessgerät, Prüfmittel-Nr.: TEM0456

Kalibrierheizeinheit, Prüfmittel-Nr: TSY0499

Kalibrierheizeinheit, Prüfmittel-Nr: TSY0500

Kalibrierheizeinheit, Prüfmittel-Nr: TSY0501

Test equipment used:

Reference measuring disk for temperature adjustment, test equipment no.: TEM0571

Temperature measuring device, test equipment no.: TEM0456

Heating device for calibration, test equipment no.: TSY 0499

Heating device for calibration, test equipment no.: TSY 0500

Heating device for calibration, test equipment no.: TSY 0501

Rückführbar auf:

- Physikalisch-Technische Bundesanstalt (PTB)

- DKD-Kalibrierlabor für Temperaturmessgeräte

Traceable to:

- Physikalisch-Technische Bundesanstalt (PTB)

[German Federal Institute of Physics and Metrology]

- DKD calibration laboratory (DKD= German calibration Service) for temperature measuring equipment

Der Benutzer ist für die Einhaltung einer angemessenen Frist zur Wiederholung der Kalibrierung verantwortlich.

Es wird ein Kalibrierrhythmus von 1 Jahr empfohlen; gerechnet vom Kaufdatum für die erste Rekalibrierung.

The user shall be responsible for meeting reasonable repeat calibration deadlines.

One-year regular calibration intervals are recommended; calculated from the buying date for the first recalibration.

Das Heizungsabgleichset und das Temperatur-Messgerät waren am Tag der Kalibrierung in einwandfreiem Zustand.

The Heating Adjustment Set and the thermometer was in perfect condition on the date of initial calibration.

Messobjekt: Temperatur-Messgerät ( GMH175 )  
Test object: Thermometer (GMH 175 )

Seriennummer: 1234567890

Serial number:

Prüfmittel-Nr:

No of test equipment:

Zertifikatsnummer: 2015/00a

Certificate number:

Messmethode: Widerstandsmessung, elektrisch  
Test method: Measurement of electrical resistance

Messpunkte: 80°C, 140°C, 190°C \*  
Measuring points:

Referenz-Objekt	Meßobjekt	Anzeige-korrektur	Meßunsicherheit	Raumtemperatur
Reference object	Test object	Display correction	±	± 0,5 °C
[°C]	[°C]	[°C]	[°C]	[°C]
80,0	79,8	0,2	0,16°C	23,2
140,0	140,2	-0,2	0,16°C	23,2
190,0	190,3	-0,3	0,27°C	23,3

Verwendete Prüfmittel:

Kalibrator Fluke 724, Prüfmittel-Nr: TSY0473

\* - Der Temperaturwert wird gem. EN60751:1995 aus dem elektrischen Widerstand umgerechnet.

Test equipment used:

Fluke 724 Calibrator, test equipment no.: TSY0473

\* - the temperature value is given bei calculation of the electrical resistance reg. IEC60751:1995

Rückführbar auf:

- Physikalisch-Technische Bundesanstalt (PTB)

Traceable to:

- Physikalisch-Technische Bundesanstalt (PTB)

[German Federal Institute of Physics and Metrology]

Datum und Ort der Kalibrierung: Göttingen 15. Aug. 2015

Date and place of calibration:

Bearbeiter: \_\_\_\_\_

Prepared by: Bearbeiter

Prüfer: \_\_\_\_\_

Inspector: Prüfer

Sartorius Lab Instruments GmbH & Co. KG  
Otto-Brenner-Strasse 20  
37079 Goettingen, Germany

Phone: +49.551.308.0  
Fax: +49.551.308.3289  
www.sartorius.com

The information and figures contained in these instructions correspond to the version date specified below.

Sartorius reserves the right to make changes to the technology, features, specifications and design of the equipment without notice.

Masculine or feminine forms are used to facilitate legibility in these instructions and always simultaneously denote the other gender as well.

Copyright notice:

This instruction manual, including all of its components, is protected by copyright. Any use beyond the limits of the copyright law is not permitted without our approval. This applies in particular to reprinting, translation and editing irrespective of the type of media used.

© Sartorius Germany

Last updated:  
05 | 2016

Printed in the EU on paper bleached  
without chlorine. | UB  
Publication No.: WYT6009-e160601