

Ultrafiltration Family



turning science into solutions

Vivaspin Ultrafiltration Family – Sample Concentration up to 20 ml Initial Volume

With their broad range of volume capacities and MWCOs, Vivaspin centrifugal concentrators offer the optimal solution to any concentration or buffer exchange application.

Due to their particular vertical membrane design they achieve highest flow rates and recoveries.

The patented dead-stop technology allowing direct recovery of the concentrate without further respin assures incomparably safe sample handling and convenience.



Vivaspin 500

500 μ l* – 5 μ l**



Vivaspin 2

2 ml – 8 μ l



Vivaspin 6

6 ml – 30 μ l



Vivaspin 15R

15 ml – 30 μ l

Vivaspin Applications

- Concentration of biological samples containing antigens, antibodies or enzymes
- Concentration of diluted protein samples from chromatography eluates
- Desalting or diafiltration | buffer exchange
- Sample concentration for crystallization and NMR spectroscopy
- Removal of very small or large contaminants

Features

- Vertical, large membrane design
- Integrated Dead-Stop-Volume
- Low-binding materials
- No Re-spin necessary
- Broad volume range from 0.5 – 20 ml
- Wide MWCO range from 2 kDa – 0.2 μ m

Benefits

- Fast, minimal membrane blocking
- No risk (to concentrate to dryness)
- High recovery
- Easy handling, fast
- High volume flexibility
- High MWCO flexibility

Features

- Vivaspin Turbo range for fastest concentration speed and highest recoveries
- Angular dead-stop pocket in Vivaspin Turbo range

Benefits

- Saving time combined with virtually complete concentrate recovery
- Easy and complete concentrate recovery due to pipette friendly access



Vivaspin 20
20 ml – 50 μ l



Vivaspin Turbo 4
4 ml – 30 μ l



Vivaspin Turbo 15
15 ml – 100 μ l



* Volume
** Dead stop vol.

Vivaspin Ultrafiltration Family – Sample Concentration up to 20 ml Initial Volume

With their broad range of volume capacities and MWCOs, Vivaspin centrifugal concentrators offer the optimal solution to any concentration or buffer exchange application.

Due to their particular vertical membrane design they achieve highest flow rates and recoveries.

The patented dead-stop technology allowing direct recovery of the concentrate without further respin assures incomparably safe sample handling and convenience.



Vivaspin 500

500 μ l* – 5 μ l**



Vivaspin 2

2 ml – 8 μ l



Vivaspin 6

6 ml – 30 μ l



Vivaspin 15R

15 ml – 30 μ l

Vivaspin Applications

- Concentration of biological samples containing antigens, antibodies or enzymes
- Concentration of diluted protein samples from chromatography eluates
- Desalting or diafiltration | buffer exchange
- Sample concentration for crystallization and NMR spectroscopy
- Removal of very small or large contaminants

Features

- Vertical, large membrane design
- Integrated Dead-Stop-Volume
- Low-binding materials
- No Re-spin necessary
- Broad volume range from 0.5 – 20 ml
- Wide MWCO range from 2 kDa – 0.2 μ m

Benefits

- Fast, minimal membrane blocking
- No risk (to concentrate to dryness)
- High recovery
- Easy handling, fast
- High volume flexibility
- High MWCO flexibility

Ordering Information

Vivaspin – PES Membrane

MWCO	3 kDa	5 kDa ¹⁾	10 kDa ¹⁾	30 kDa ¹⁾	50 kDa ¹⁾	100 kDa ¹⁾	300 kDa	1,000 kDa	0.2 µm	¹⁾ 5 of each	
Product	Volume	Dead-stop vol.									
Vivaspin 500	0.5 ml	5 µl	V50111 (25)	V50101 (25)	V50121 (25)	V50131 (25)	V50141 (25)	V50151 (25)	V50161 (25)	V50171 (25)	V50151 (25)
			V50192 (100)	V50102 (100)	V50122 (100)	V50132 (100)	V50142 (100)	V50152 (100)	V50162 (100)	V50172 (100)	V50152 (100)
Vivaspin 2	2 ml	8 µl	V50291 (25)	V50201 (25)	V50221 (25)	V50231 (25)	V50241 (25)	V50251 (25)	V50261 (25)	V50271 (25)	V50251 (25)
			V50292 (100)	V50202 (100)	V50222 (100)	V50232 (100)	V50242 (100)	V50252 (100)	V50262 (100)	V50272 (100)	V50252 (100)
Vivaspin Turbo 4	4 ml	30 µl	V504191 (25)	V504101 (25)	V504121 (25)	V504131 (25)	V504141 (25)				
			V504192 (100)	V504102 (100)	V504122 (100)	V504132 (100)	V504142 (100)				
Vivaspin 6	6 ml	30 µl	V50691 (25)	V50601 (25)	V50621 (25)	V50631 (25)	V50641 (25)	V50651 (25)	V50661 (25)	V50671 (25)	V50651 (25)
			V50692 (100)	V50602 (100)	V50622 (100)	V50632 (100)	V50642 (100)	V50652 (100)	V50662 (100)	V50672 (100)	V50652 (100)
Vivaspin Turbo 15	15 ml	100 µl	V515191	V515101 (12)	V515121 (12)	V515131 (12)	V515141 (12)				
			V515191	V515102 (48)	V515122 (48)	V515132 (48)	V515142 (48)				
Vivaspin 20	20 ml	50 µl	V52091 (12)	V52011 (12)	V52021 (12)	V52031 (12)	V52041 (12)	V52051 (12)	V52061 (12)	V52071 (12)	V52051 (12)
			V52092 (48)	V52012 (48)	V52022 (48)	V52032 (48)	V52042 (48)	V52052 (48)	V52062 (48)	V52072 (48)	V52052 (48)

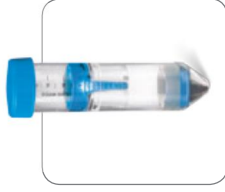

Vivaspin 20
20 ml – 50 µl

Vivaspin – Hydrosart® Membrane

MWCO	2 kDa	5 kDa	10 kDa	30 kDa
Product	Volume	Dead-stop vol.		
Vivaspin 2	2 ml	8 µl	V502H91 (25)*	V502H01 (25)
			V502H92 (100)	V502H02 (100)
Vivaspin 15R	15 ml	30 µl	V515RH91 (12)	V515RH01 (12)
			V515RH92 (48)	V515RH02 (48)

Vivaspin – CTA Membrane

MWCO	5 kDa	10 kDa	20 kDa
Product	Volume	Dead-stop vol.	
Vivaspin 2	2 ml	8 µl	V502U1 (25)
			V502U2 (100)

Vivaspin Additional Devices

Product Description	Qty per Box	Order No.
Vivaspin 20 – Diafiltration cups	12	VSA005

* Volume
** Dead-stop vol.
(Qty per box in parenthesis)



Vivacell Pressure Units – Sample Concentration up to 250 ml Initial Volume

Vivacell – Put your proteins under pressure! Pressurization, centrifugation or both – the choice is yours. Sartorius offers the Vivacell product range of pressurizable and centrifugal concentrators for sample volumes from 20 ml to 250 ml. The patented vertical membrane design guarantees highest performance and unmatched flexibility.

Vivacell products are unique and innovative concentrators that can be pressurized and centrifuged, or a combination of both for fast and safe sample concentration.

Benefit from our patented dead-stop technology, high process speeds and direct concentrate recovery without the need for reverse spinning!

Vivacell Family

Vivacell 70 – Centrifugation | Pressure

MWCO	Vivacell 70; Volume = 70 ml; Dead stop vol. = 150 µl
5 kDa	VS6011 (2)*, VS6012 (10)
10 kDa	VS6001 (2), VS6002 (10)
30 kDa	VS6021 (2), VS6022 (10)
50 kDa	VS6031 (2), VS6032 (10)
100 kDa	VS6041 (2), VS6042 (10)
0.2 µm	VS6071 (2), VS6072 (10)



Vivacell 100 – Centrifugation | Pressure

MWCO	Vivacell 100; Volume = 100 ml; Dead stop vol. = 350 µl
5 kDa	VC1011 (2), VC1012 (10)
10 kDa	VC1001 (2), VC1002 (10)
30 kDa	VC1021 (2), VC1022 (10)
50 kDa	VC1031 (2), VC1032 (10)
100 kDa	VC1041 (2), VC1042 (10)
300 kDa	VC1051 (2), VC1052 (10)
1,000 kDa	VC1061 (2), VC1062 (10)
0.2 µm	VC1071 (2), VC1072 (10)



Vivacell 250 – Pressure

MWCO	Vivacell 250; Volume = 250 ml; Dead stop vol. = 600 µl
5 kDa	VC2511 (5)
10 kDa	VC2501 (5)
30 kDa	VC2521 (5)
50 kDa	VC2531 (5)
100 kDa	VC2541 (5)
0.2 µm	VC2571 (5)



* (Qty per box in parenthesis)

Vivacell – Accessories for Different Applications

APC

Description	Qty per Box	Order No.
Air Pressure Controller		
Includes pressure gauge, regulator, over-pressure safety valve, female connector and 1 m extension line (4 mm pneumatic tubing) with connectors and inlet-tubing	1	VCA002

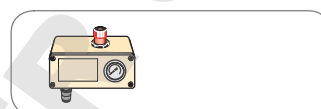

Vivacell 70

Description	Qty per Box	Order No.
Centrifugation		
Vivacell centrifuge bottle-standard caps – swing out rotor	4	VSA003
Modified caps with centrifuge bottle – fixed angle rotor	2	VCA004
Pressurize & Pressure-shake		
Female connector	1	VCA010
Male connector	1	VCA011
4 mm pneumatic tubing	1	VCA012
Pressure head with reservoir and filtrate bottle	1	VCA700
Pressure-fugea		
Charge valve for pressure-fuge head	1	VCA005
Vivacell replacement seals for pressure-fuge head	10	VCA007
Female connector	1	VCA010
Male connector	1	VCA011
4mm pneumatic tubing	1	VCA012
Pressure-fuge head	2	VCA701

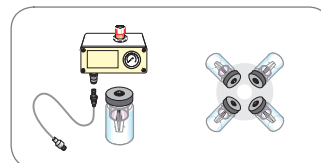
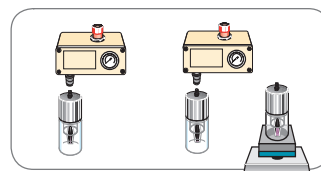
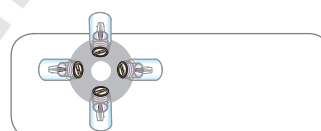

Vivacell 100

Description	Qty per Box	Order No.
Pressurize & Pressure-shake		
Sanoprene replacement seals	10	VCA014
Female connector	1	VCA010
Male connector	1	VCA011
4 mm pneumatic tubing	1	VCA012
Pressure head with replacement seals (5)	1	VCA800

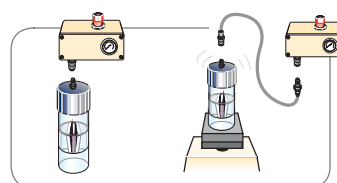

Vivacell 250

Description	Qty per Box	Order No.
Pressurize & Pressure-shake		
Replacement pressure indicator	1	VCA008
Vivacell maintenance kit (sample reservoir, filtrate container and O-ring seals)	1	VCA009
Female connector	1	VCA010
Male connector	1	VCA011
4 mm pneumatic tubing	1	VCA012
Replacement pressure head & screw closure	1	VCA015
Vivacell 250 complete with accessories	1	VCA250
Vivacell 250 starter kit	5	VC25S1

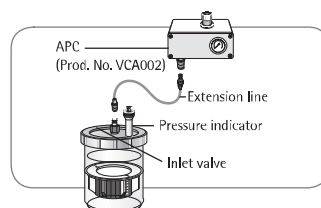

Vivaflow Crossflow Cassettes – Sample Concentration up to 5 l

Plug and Play Convenience – Vivaflow units are easy to use, and provide an optimal performance, flexibility and economy which is unrivalled by any crossflow system on the market for laboratory needs. The devices are easy to set up and need only a standard peristaltic pump to operate.

Vivaflow Setup

100 ml to 3 Liters

Vivaflow 50 is a disposable, modular crossflow device, which can be easily scaled up to 6 units that run both in parallel and in series. Vivaflow 50 saves regeneration time and is the economical choice for concentration and buffer exchange of 0.1 ml to 3 l samples containing proteins, viruses and nanoparticles.

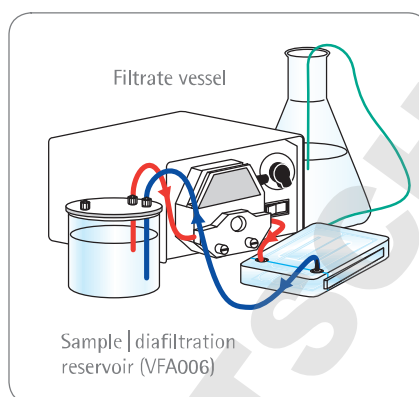

Vivaflow 50
Single module

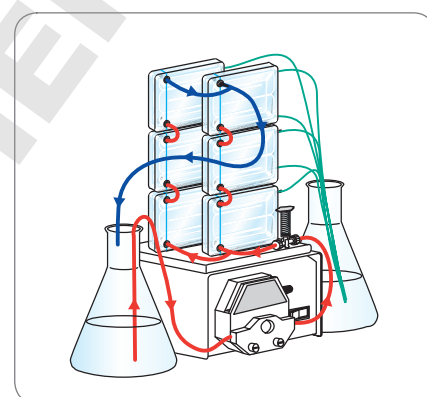

Vivaflow 50
Multiple modules

100 ml to 1 Liter

Vivaflow 50R is a reusable crossflow device featuring a unique, low-binding modified regenerated cellulose membrane, Hydrosart[®]. Therefore, it is the ideal choice for concentrating expensive samples like viruses and antibodies. Vivaflow 50R can be scaled up with one additional unit to increase the flow speed for concentrating initial sample volumes of up to 1 l.

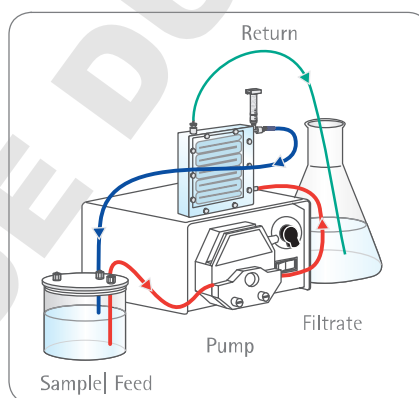

Vivaflow 50R
Single module

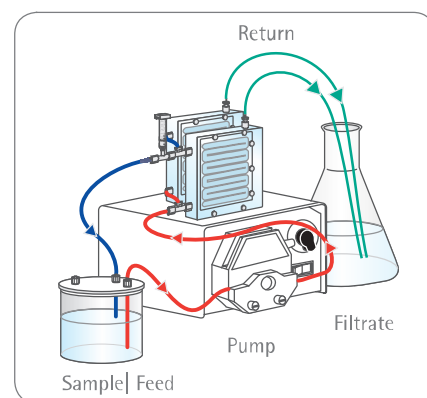

Vivaflow 50R
Two modules

0.5 to 5 Liters

Vivaflow 200, like Vivaflow 50R, is a reusable crossflow device, but is available in a choice of membranes: modified regenerated cellulose, Hydrosart[®] and PES. This device is perfect for concentrating expensive samples like viruses and antibodies. Vivaflow 200 can be scaled up with one additional unit to increase the flow speed for concentrating initial sample volumes of up to 5 l.

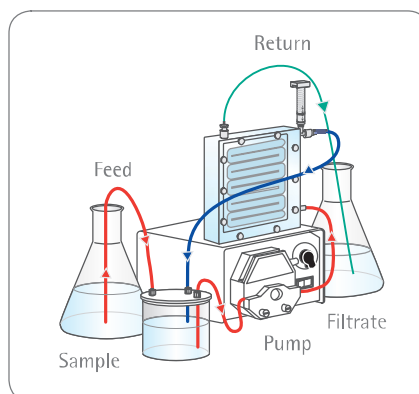

Vivaflow 200
Single module

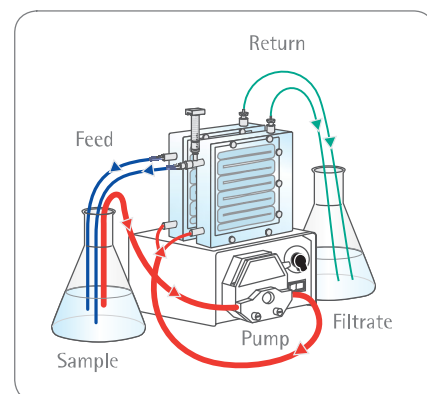

Vivaflow 200
Two modules

Vivaflow Applications

- Antibody | recombinant protein concentration | diafiltration in biopharma research
- Concentration of small production lots of proteins for diagnostic purposes
- Concentration of viruses from cell culture supernatants or of environmental samples
- Nanoparticle concentration

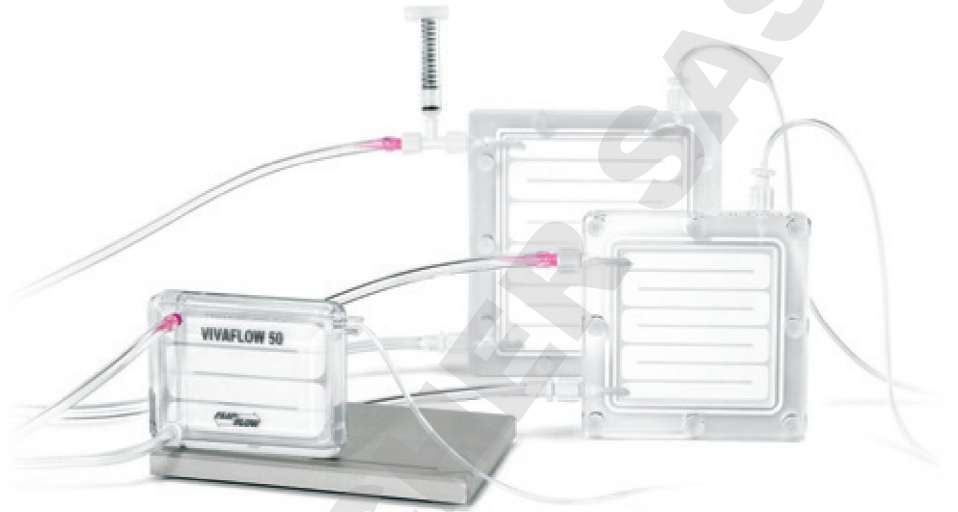

Ordering Information

Vivaflow – PES Membrane

MWCO			3 kDa	5 kDa	10 kDa	30 kDa	50 kDa	100 kDa	1000 kDa	0.2 µm
Product	Volume**	Min vol.								
Vivaflow 50	3 l	10 ml	VF05P9 (2)*	VF05P1 (2)*	VF05P0 (2)	VF05P2 (2)	VF05P3 (2)	VF05P4 (2)	VF05P6 (2)	VF05P7 (2)
Vivaflow 200	5 l	20 ml	VF20P9 (1)	VF20P1 (1)	VF20P0 (1)	VF20P2 (1)	VF20P3 (1)	VF20P4 (1)		VF20P7 (1)

Vivaflow – RC Membrane

MWCO	100 kDa									
Product	Volume**	Min vol.								
Vivaflow 50	3 l	10 ml	VF05C4 (2)*							

Vivaflow – Hydrosart® Membrane

MWCO			2 kDa	5 kDa	10 kDa	30 kDa	100 kDa	
Product	Volume**	Min vol.						
Vivaflow 50R	1 l	10 ml			VF05H1	VF05H0	VF05H2	VF05H4
Vivaflow 200	5 l	20 ml	VF 20H9	VF20H1	VF20H0	VF20H2	VF20H4	

Vivaflow – Complete System (Pump, Easy Load Pump Head & Tubing)

Product Description	Order No.
Vivaflow 50	VFS504
Vivaflow 50R 200	VFS204

* (Qty per box in parenthesis)

** Volume refers to maximal recommended volume with multiple units

Sales and Service Contacts

For further contacts, visit www.sartorius.com

Europe

Germany
Sartorius Lab Instruments
GmbH & Co. KG
Weender Landstrasse 94–108
37075 Goettingen
Phone +49.551.308.0
Fax +49.551.308.3289

France Et Suisse Romande
Sartorius France
2, rue Antoine Laurent de Lavoisier
ZA de la Gaudriée
91410 Dourdan
Phone +33.1.70.62.50.00
Fax +33.1.64.59.76.39

Austria
Sartorius Austria GmbH
Franzosengraben 12
1030 Vienna
Phone +43.1.7965760.0
Fax +43.1.7965760.24

Belgium
Sartorius Belgium N.V.
Leuvensesteenweg, 248/B
1800 Vilvoorde
Phone +32.2.756.06.71
Fax +32.2.253.45.95

Finland & Baltics
Sartorius Biohit Liquid Handling Oy
Laippatie 1
00880 Helsinki
Phone +358.9.755.951
Fax +358.9.755.95.200

Hungary
Sartorius Hungária Kft.
Kagyló u. 5.
2092 Budakeszi
Phone +3623.457.227
Fax +3623.457.147

Ireland
Sartorius Ireland Ltd.
Unit 41, The Business Centre
Stadium Business Park
Ballycoolin Road
Dublin 11
Phone +353.1.8089050
Fax +353.1.8089388

Italy
Sartorius Italy S.r.l.
Viale A. Casati, 4
20835 Muggiò (MB)
Phone +39.039.4659.1
Fax +39.039.4659.88

Netherlands
Sartorius Netherlands B.V.
Phone +31.30.60.53.001
Fax +31.30.60.52.917
info.netherlands@sartorius.com

Poland
Sartorius Poland sp.z o.o.
ul. Wrzesinska 70
62-025 Kostrzyn
Phone +48.61.6473830
Fax +48.61.6473839

Russian Federation
LLC "Sartorius ICR" and LLC "Biohit"
Uralskaya str. 4, Lit. B
199155, Saint-Petersburg
Phone +7.812.327.5.327
Fax +7.812.327.5.323

Spain Et Portugal
Sartorius Spain, S.A.
Avda. de la Industria, 32
Edificio PAYMA
28108 Alcobendas (Madrid)
Phone Spain +34.902.123.367
Phone Portugal +351.800.855.800
Fax Spain +34.91.358.96.23
Fax Portugal +351.800.855.799

Switzerland
Sartorius Mechatronics Switzerland AG
Ringstrasse 24a
8317 Tagelswangen (ZH)
Phone +41.44.746.50.00
Fax +41.44.746.50.50

U.K.
Sartorius UK Ltd.
Longmead Business Centre
Blenheim Road, Epsom
Surrey KT19 9QQ
Phone +44.1372.737159
Fax +44.1372.726171

Ukraine
LLC "Biohit"
Post Box 440 "B"
01001 Kiev, Ukraine
Phone +380.44.411.4918
Fax +380.50.623.3162

America

USA
Sartorius Corporation
5 Orville Drive, Suite 200
Bohemia, NY 11716
Phone +1.631.254.4249
Toll-free +1.800.635.2906
Fax +1.631.254.4253

Argentina
Sartorius Argentina S.A.
Int. A. Ávalos 4251
B1605ECS Munro
Buenos Aires
Phone +54.11.4721.0505
Fax +54.11.4762.2333

Brazil
Sartorius do Brasil Ltda
Avenida Senador Vergueiro 2962
São Bernardo do Campo
CEP 09600-000 – SP– Brasil
Phone +55.11.4362.8900
Fax +55.11.4362.8901

Canada
Sartorius Canada Inc.
2179 Dunwin Drive #4
Mississauga, ON L5L 1X2
Phone +1.905.569.7977
Toll-Free +1.800.668.4234
Fax +1.905.569.7021

Mexico
Sartorius de México S.A. de C.V.
Circuito Circunvalación Poniente
No. 149
Ciudad Satélite
53100, Estado de México
México
Phone +52.5555.62.1102
Fax +52.5555.62.2942

Asia | Pacific

Australia
Sartorius Australia Pty. Ltd.
Unit 5, 7-11 Rodeo Drive
Dandenong South Vic 3175
Phone +61.3.8762.1800
Fax +61.3.8762.1828

China
Sartorius Scientific
Instruments (Beijing) Co., Ltd.
33 Yu An Road, Airport Industrial Park
Zone B,
Shunyi District, Beijing 101300,
P.R.China
Phone +86.10.8042.6300
Fax +86.10.8042.6486

Hong Kong
Sartorius Hong Kong Ltd.
Unit 1012, Lu Plaza
2 Wing Yip Street
Kwun Tong
Kowloon, Hong Kong
Phone +852.2774.2678
Fax +852.2766.3526

India
Sartorius Weighing India Pvt. Ltd.
#69/2-69/3, NH 48, Jakkasandra,
Nelamangala Tq
562 123 Bangalore, India
Phone +91.80.4350.5250
Fax +91.80.4350.5253

Japan
Sartorius Japan K.K.
4th Fl., Daiwa Shinagawa North Bldg.
8-11, Kita-Shinagawa 1-chome
Shinagawa-ku, Tokyo, 140-0001 Japan
Phone +81.3.3740.5408
Fax +81.3.3740.5406

Malaysia
Sartorius Malaysia Sdn. Bhd
Lot L3-E-3B, Enterprise 4
Technology Park Malaysia
Bukit Jalil
57000 Kuala Lumpur, Malaysia
Phone +60.3.8996.0622
Fax +60.3.8996.0755

Singapore
Sartorius Singapore Pte. Ltd
1 Science Park Road,
The Capricorn, #05-08A,
Singapore Science Park II
Singapore 117528
Phone +65.6872.3966
Fax +65.6778.2494

South Korea
Sartorius Korea Ltd.
8th Floor, Solid Space B/D,
PanGyoYeok-Ro 220, Bundang-Gu
SeongNam-Si, GyeongGi-Do, 463-400
Phone +82.31.622.5700
Fax +82.31.622.5799

Thailand
Sartorius (Thailand) Co. Ltd.
129 Rama 9 Road,
Huaykwang
Bangkok 10310
Phone +66.2643.8361-6
Fax +66.2643.8367



◀ www.sartorius.com