

Ultrafiltration Family



turning science into solutions

Vivaspin Ultrafiltration Family – Sample Concentration up to 20 ml Initial Volume

With their broad range of volume capacities and MWCOs, Vivaspin centrifugal concentrators offer the optimal solution to any concentration or buffer exchange application.

Due to their particular vertical membrane design they achieve highest flow rates and recoveries.

The patented dead-stop technology allowing direct recovery of the concentrate without further respin assures incomparably safe sample handling and convenience.



Vivaspin 500

500 μ l* – 5 μ l**



Vivaspin 2

2 ml – 8 μ l



Vivaspin 6

6 ml – 30 μ l



Vivaspin 15R

15 ml – 30 μ l

Vivaspin Applications

- Concentration of biological samples containing antigens, antibodies or enzymes
- Concentration of diluted protein samples from chromatography eluates
- Desalting or diafiltration | buffer exchange
- Sample concentration for crystallization and NMR spectroscopy
- Removal of very small or large contaminants

Features

- Vertical, large membrane design
- Integrated Dead-Stop-Volume
- Low-binding materials
- No Re-spin necessary
- Broad volume range from 0.5 – 20 ml
- Wide MWCO range from 2 kDa – 0.2 μ m

Benefits

- Fast, minimal membrane blocking
- No risk (to concentrate to dryness)
- High recovery
- Easy handling, fast
- High volume flexibility
- High MWCO flexibility

Features

- Vivaspin Turbo range for fastest concentration speed and highest recoveries
- Angular dead-stop pocket in Vivaspin Turbo range

Benefits

- Saving time combined with virtually complete concentrate recovery
- Easy and complete concentrate recovery due to pipette friendly access



Vivaspin 20

20 ml – 50 μ l



Vivaspin Turbo 4

4 ml – 30 μ l



Vivaspin Turbo 15

15 ml – 100 μ l



* Volume

** Dead stop vol.

Vivaspin Ultrafiltration Family – Sample Concentration up to 20 ml Initial Volume

With their broad range of volume capacities and MWCOs, Vivaspin centrifugal concentrators offer the optimal solution to any concentration or buffer exchange application.

Due to their particular vertical membrane design they achieve highest flow rates and recoveries.

The patented dead-stop technology allowing direct recovery of the concentrate without further respin assures incomparably safe sample handling and convenience.



Vivaspin 500

500 μ l* – 5 μ l**



Vivaspin 2

2 ml – 8 μ l



Vivaspin 6

6 ml – 30 μ l



Vivaspin 15R

15 ml – 30 μ l

Vivaspin Applications

- Concentration of biological samples containing antigens, antibodies or enzymes
- Concentration of diluted protein samples from chromatography eluates
- Desalting or diafiltration | buffer exchange
- Sample concentration for crystallization and NMR spectroscopy
- Removal of very small or large contaminants

Features

- Vertical, large membrane design
- Integrated Dead-Stop-Volume
- Low-binding materials
- No Re-spin necessary
- Broad volume range from 0.5 – 20 ml
- Wide MWCO range from 2 kDa – 0.2 μ m

Benefits

- Fast, minimal membrane blocking
- No risk (to concentrate to dryness)
- High recovery
- Easy handling, fast
- High volume flexibility
- High MWCO flexibility

Ordering Information

Vivaspin – PES Membrane

| MWCO | 3 kDa | 5 kDa ¹⁾ | 10 kDa ¹⁾ | 30 kDa ¹⁾ | 50 kDa ¹⁾ | 100 kDa ¹⁾ | 300 kDa | 1,000 kDa | 0.2 µm | ¹⁾ 5 of each | |
|-------------------|--------|---------------------|----------------------|----------------------|----------------------|-----------------------|---------------|--------------|--------------|-------------------------|--------------|
| Product | Volume | Dead-stop vol. | | | | | | | | | |
| Vivaspin 500 | 0.5 ml | 5 µl | V50111 (25) | V50101 (25) | V50121 (25) | V50131 (25) | V50141 (25) | V50151 (25) | V50161 (25) | V50171 (25) | V50151 (25) |
| | | | V50192 (100) | V50102 (100) | V50122 (100) | V50132 (100) | V50142 (100) | V50152 (100) | V50162 (100) | V50172 (100) | V50152 (100) |
| Vivaspin 2 | 2 ml | 8 µl | V50291 (25) | V50201 (25) | V50221 (25) | V50231 (25) | V50241 (25) | V50251 (25) | V50261 (25) | V50271 (25) | V50251 (25) |
| | | | V50292 (100) | V50202 (100) | V50222 (100) | V50232 (100) | V50242 (100) | V50252 (100) | V50262 (100) | V50272 (100) | V50252 (100) |
| Vivaspin Turbo 4 | 4 ml | 30 µl | V504191 (25) | V504101 (25) | V504121 (25) | V504131 (25) | V504141 (25) | | | | |
| | | | V504192 (100) | V504102 (100) | V504122 (100) | V504132 (100) | V504142 (100) | | | | |
| Vivaspin 6 | 6 ml | 30 µl | V50691 (25) | V50601 (25) | V50621 (25) | V50631 (25) | V50641 (25) | V50651 (25) | V50661 (25) | V50671 (25) | V50651 (25) |
| | | | V50692 (100) | V50602 (100) | V50622 (100) | V50632 (100) | V50642 (100) | V50652 (100) | V50662 (100) | V50672 (100) | V50652 (100) |
| Vivaspin Turbo 15 | 15 ml | 100 µl | V515191 | V515101 (12) | V515121 (12) | V515131 (12) | V515141 (12) | | | | |
| | | | V515191 | V515102 (48) | V515122 (48) | V515132 (48) | V515142 (48) | | | | |
| Vivaspin 20 | 20 ml | 50 µl | V52091 (12) | V52011 (12) | V52021 (12) | V52031 (12) | V52041 (12) | V52051 (12) | V52061 (12) | V52071 (12) | V52051 (12) |
| | | | V52092 (48) | V52012 (48) | V52022 (48) | V52032 (48) | V52042 (48) | V52052 (48) | V52062 (48) | V52072 (48) | V52052 (48) |

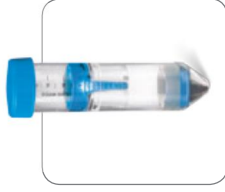

Vivaspin 20
20 ml – 50 µl

Vivaspin – Hydrosart® Membrane

| MWCO | 2 kDa | 5 kDa | 10 kDa | 30 kDa |
|--------------|--------|----------------|---------------|---------------|
| Product | Volume | Dead-stop vol. | | |
| Vivaspin 2 | 2 ml | 8 µl | V502H91 (25)* | V502H01 (25) |
| | | | V502H92 (100) | V502H02 (100) |
| Vivaspin 15R | 15 ml | 30 µl | V515RH91 (12) | V515RH01 (12) |
| | | | V515RH92 (48) | V515RH02 (48) |

Vivaspin – CTA Membrane

| MWCO | 5 kDa | 10 kDa | 20 kDa | |
|------------|--------|----------------|--------------|--------------|
| Product | Volume | Dead-stop vol. | | |
| Vivaspin 2 | 2 ml | 8 µl | V502U1 (25) | V502X1 (25) |
| | | | V502U2 (100) | V502X2 (100) |

Vivaspin Additional Devices

| Product Description | Qty per Box | Order No. |
|----------------------------------|-------------|-----------|
| Vivaspin 20 – Diafiltration cups | 12 | V5A005 |

* Volume
** Dead-stop vol.
(Qty per box in parenthesis)



Vivacell Pressure Units – Sample Concentration up to 250 ml Initial Volume

Vivacell – Put your proteins under pressure! Pressurization, centrifugation or both – the choice is yours. Sartorius offers the Vivacell product range of pressurizable and centrifugal concentrators for sample volumes from 20 ml to 250 ml. The patented vertical membrane design guarantees highest performance and unmatched flexibility.

Vivacell products are unique and innovative concentrators that can be pressurized and centrifuged, or a combination of both for fast and safe sample concentration.

Benefit from our patented dead-stop technology, high process speeds and direct concentrate recovery without the need for reverse spinning!

Vivacell Family

Vivacell 70 – Centrifugation | Pressure

| MWCO | Vivacell 70; Volume = 70 ml; Dead stop vol. = 150 µl |
|---------|--|
| 5 kDa | VS6011 (2)*, VS6012 (10) |
| 10 kDa | VS6001 (2), VS6002 (10) |
| 30 kDa | VS6021 (2), VS6022 (10) |
| 50 kDa | VS6031 (2), VS6032 (10) |
| 100 kDa | VS6041 (2), VS6042 (10) |
| 0.2 µm | VS6071 (2), VS6072 (10) |



Vivacell 100 – Centrifugation | Pressure

| MWCO | Vivacell 100; Volume = 100 ml; Dead stop vol. = 350 µl |
|-----------|--|
| 5 kDa | VC1011 (2), VC1012 (10) |
| 10 kDa | VC1001 (2), VC1002 (10) |
| 30 kDa | VC1021 (2), VC1022 (10) |
| 50 kDa | VC1031 (2), VC1032 (10) |
| 100 kDa | VC1041 (2), VC1042 (10) |
| 300 kDa | VC1051 (2), VC1052 (10) |
| 1,000 kDa | VC1061 (2), VC1062 (10) |
| 0.2 µm | VC1071 (2), VC1072 (10) |



Vivacell 250 – Pressure

| MWCO | Vivacell 250; Volume = 250 ml; Dead stop vol. = 600 µl |
|---------|--|
| 5 kDa | VC2511 (5) |
| 10 kDa | VC2501 (5) |
| 30 kDa | VC2521 (5) |
| 50 kDa | VC2531 (5) |
| 100 kDa | VC2541 (5) |
| 0.2 µm | VC2571 (5) |



* (Qty per box in parenthesis)

Vivacell – Accessories for Different Applications

APC

| Description | Qty per Box | Order No. |
|--|-------------|-----------|
| Air Pressure Controller | | |
| Includes pressure gauge, regulator, over-pressure safety valve, female connector and 1 m extension line (4 mm pneumatic tubing) with connectors and inlet-tubing | 1 | VCA002 |

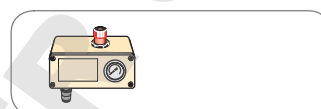

Vivacell 70

| Description | Qty per Box | Order No. |
|--|-------------|-----------|
| Centrifugation | | |
| Vivacell centrifuge bottle-standard caps – swing out rotor | 4 | VSA003 |
| Modified caps with centrifuge bottle – fixed angle rotor | 2 | VCA004 |
| Pressurize & Pressure-shake | | |
| Female connector | 1 | VCA010 |
| Male connector | 1 | VCA011 |
| 4 mm pneumatic tubing | 1 | VCA012 |
| Pressure head with reservoir and filtrate bottle | 1 | VCA700 |
| Pressure-fugea | | |
| Charge valve for pressure-fuge head | 1 | VCA005 |
| Vivacell replacement seals for pressure-fuge head | 10 | VCA007 |
| Female connector | 1 | VCA010 |
| Male connector | 1 | VCA011 |
| 4mm pneumatic tubing | 1 | VCA012 |
| Pressure-fuge head | 2 | VCA701 |

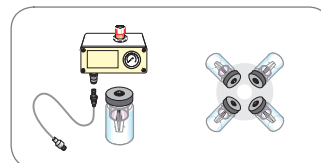
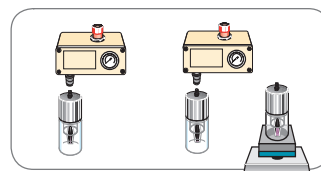
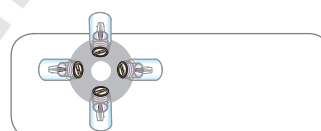

Vivacell 100

| Description | Qty per Box | Order No. |
|--|-------------|-----------|
| Pressurize & Pressure-shake | | |
| Sanoprene replacement seals | 10 | VCA014 |
| Female connector | 1 | VCA010 |
| Male connector | 1 | VCA011 |
| 4 mm pneumatic tubing | 1 | VCA012 |
| Pressure head with replacement seals (5) | 1 | VCA800 |

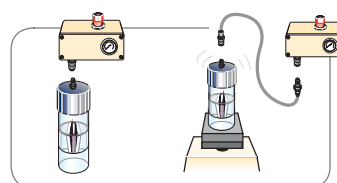

Vivacell 250

| Description | Qty per Box | Order No. |
|--|-------------|-----------|
| Pressurize & Pressure-shake | | |
| Replacement pressure indicator | 1 | VCA008 |
| Vivacell maintenance kit (sample reservoir, filtrate container and O-ring seals) | 1 | VCA009 |
| Female connector | 1 | VCA010 |
| Male connector | 1 | VCA011 |
| 4 mm pneumatic tubing | 1 | VCA012 |
| Replacement pressure head & screw closure | 1 | VCA015 |
| Vivacell 250 complete with accessories | 1 | VCA250 |
| Vivacell 250 starter kit | 5 | VC25S1 |

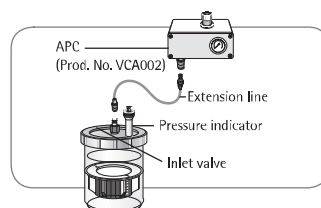

Vivaflow Crossflow Cassettes – Sample Concentration up to 5 l

Plug and Play Convenience – Vivaflow units are ease to use, and provide an optimal performance, flexibility and economy which is unrivalled by any crossflow system on the market for laboratory needs. The devices are easy to set up and need only a standard peristaltic pump to operate.

Vivaflow Setup

100 ml to 3 Liters

Vivaflow 50 is a disposable, modular crossflow device, which can be easily scaled up to 6 units that run both in parallel and in series. Vivaflow 50 saves regeneration time and is the economical choice for concentration and buffer exchange of 0.1 ml to 3 l samples containing proteins, viruses and nanoparticles.

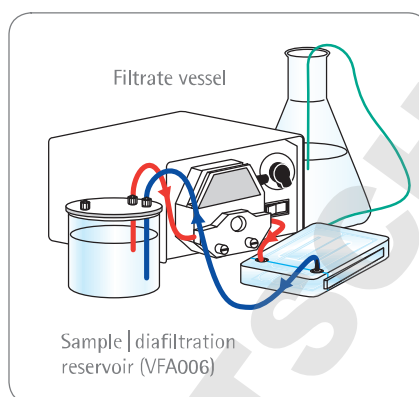

Vivaflow 50
Single module

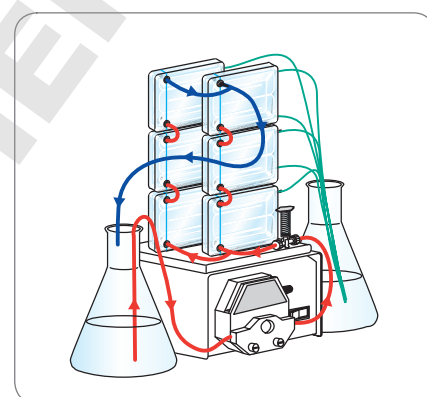

Vivaflow 50
Multiple modules

100 ml to 1 Liter

Vivaflow 50R is a reusable crossflow device featuring a unique, low-binding modified regenerated cellulose membrane, Hydrosart®. Therefore, it is the ideal choice for concentrating expensive samples like viruses and antibodies. Vivaflow 50R can be scaled up with one additional unit to increase the flow speed for concentrating initial sample volumes of up to 1 l.

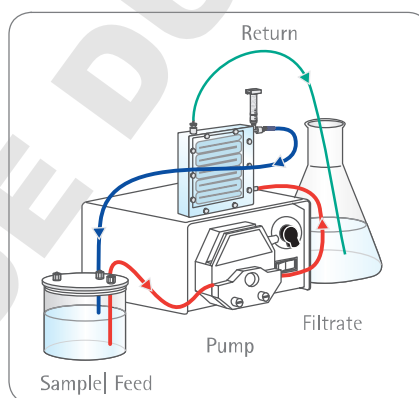

Vivaflow 50R
Single module

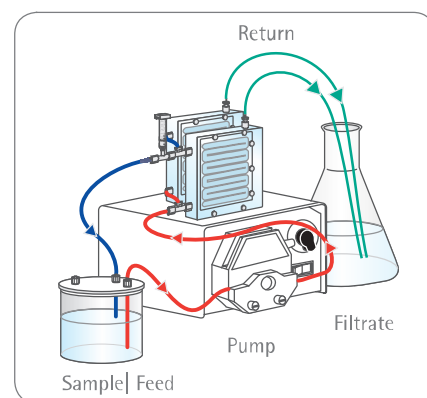

Vivaflow 50R
Two modules

0.5 to 5 Liters

Vivaflow 200, like Vivaflow 50R, is a reusable crossflow device, but is available in a choice of membranes: modified regenerated cellulose, Hydrosart® and PES. This device is perfect for concentrating expensive samples like viruses and antibodies. Vivaflow 200 can be scaled up with one additional unit to increase the flow speed for concentrating initial sample volumes of up to 5 l.

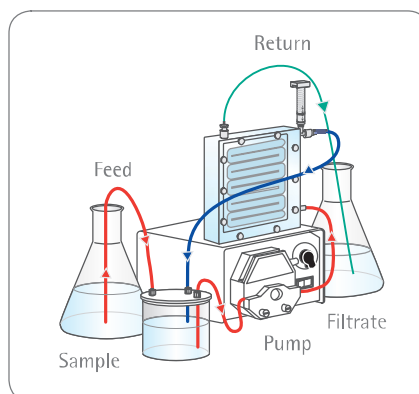

Vivaflow 200
Single module

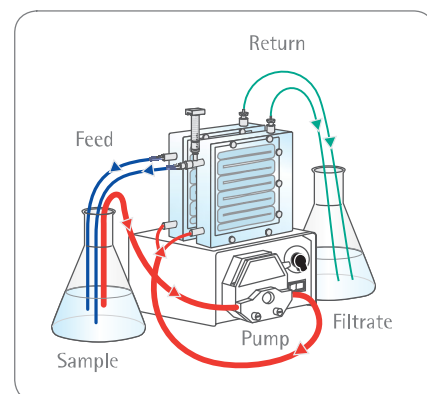

Vivaflow 200
Two modules

Vivaflow Applications

- Antibody | recombinant protein concentration | diafiltration in biopharma research
- Concentration of small production lots of proteins for diagnostic purposes
- Concentration of viruses from cell culture supernatants or of environmental samples
- Nanoparticle concentration

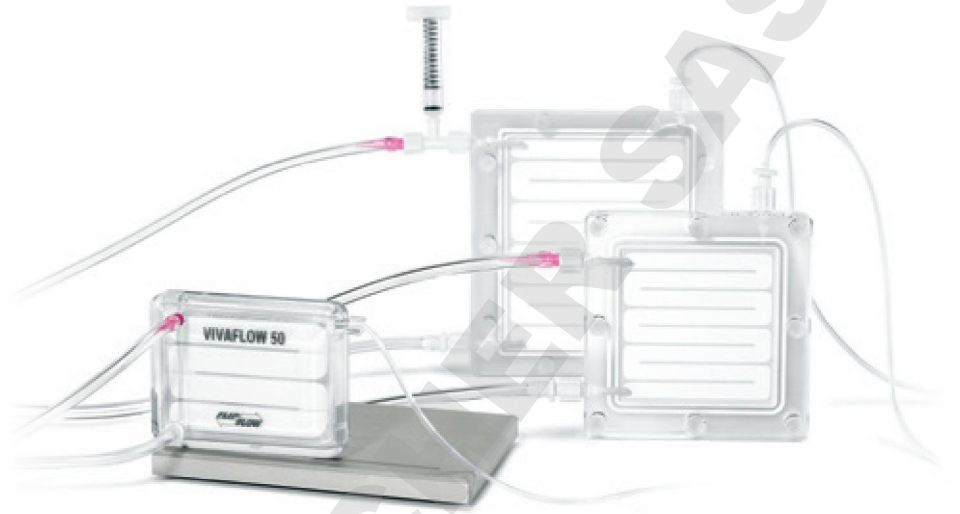

Ordering Information

Vivaflow – PES Membrane

| MWCO | | | 3 kDa | 5 kDa | 10 kDa | 30 kDa | 50 kDa | 100 kDa | 1000 kDa | 0.2 µm |
|--------------|----------|----------|-------------|-------------|------------|------------|------------|------------|------------|------------|
| Product | Volume** | Min vol. | | | | | | | | |
| Vivaflow 50 | 3 l | 10 ml | VF05P9 (2)* | VF05P1 (2)* | VF05P0 (2) | VF05P2 (2) | VF05P3 (2) | VF05P4 (2) | VF05P6 (2) | VF05P7 (2) |
| Vivaflow 200 | 5 l | 20 ml | VF20P9 (1) | VF20P1 (1) | VF20P0 (1) | VF20P2 (1) | VF20P3 (1) | VF20P4 (1) | | VF20P7 (1) |

Vivaflow – RC Membrane

| MWCO | | | 100 kDa |
|-------------|----------|----------|-------------|
| Product | Volume** | Min vol. | |
| Vivaflow 50 | 3 l | 10 ml | VF05C4 (2)* |

Vivaflow – Hydrosart® Membrane

| MWCO | | | 2 kDa | 5 kDa | 10 kDa | 30 kDa | 100 kDa |
|--------------|----------|----------|---------|--------|--------|--------|---------|
| Product | Volume** | Min vol. | | | | | |
| Vivaflow 50R | 1 l | 10 ml | | VF05H1 | VF05H0 | VF05H2 | VF05H4 |
| Vivaflow 200 | 5 l | 20 ml | VF 20H9 | VF20H1 | VF20H0 | VF20H2 | VF20H4 |

Vivaflow – Complete System (Pump, Easy Load Pump Head & Tubing)

| Product Description | Order No. |
|---------------------|-----------|
| Vivaflow 50 | VFS504 |
| Vivaflow 50R 200 | VFS204 |

* (Qty per box in parenthesis)

** Volume refers to maximal recommended volume with multiple units

Sales and Service Contacts

For further contacts, visit www.sartorius.com

Europe

Germany

Sartorius Lab Instruments
GmbH & Co. KG
Weender Landstrasse 94–108
37075 Goettingen

Phone +49.551.308.0
Fax +49.551.308.3289

France Et Suisse Romande

Sartorius France
2, rue Antoine Laurent de Lavoisier
ZA de la Gaudriée
91410 Dourdan

Phone +33.1.70.62.50.00
Fax +33.1.64.59.76.39

Austria

Sartorius Austria GmbH
Franzosengraben 12
1030 Vienna

Phone +43.1.7965760.0
Fax +43.1.7965760.24

Belgium

Sartorius Belgium N.V.
Leuvensesteenweg, 248/B
1800 Vilvoorde

Phone +32.2.756.06.71
Fax +32.2.253.45.95

Finland & Baltics

Sartorius Biohit Liquid Handling Oy
Laippatie 1
00880 Helsinki

Phone +358.9.755.951
Fax +358.9.755.95.200

Hungary

Sartorius Hungária Kft.
Kagyló u. 5.
2092 Budakeszi

Phone +3623.457.227
Fax +3623.457.147

Ireland

Sartorius Ireland Ltd.
Unit 41, The Business Centre
Stadium Business Park
Ballycoolin Road
Dublin 11

Phone +353.1.8089050
Fax +353.1.8089388

Italy

Sartorius Italy S.r.l.
Viale A. Casati, 4
20835 Muggiò (MB)

Phone +39.039.4659.1
Fax +39.039.4659.88

Netherlands

Sartorius Netherlands B.V.

Phone +31.30.60.53.001
Fax +31.30.60.52.917

info.netherlands@sartorius.com

Poland

Sartorius Poland sp.z o.o.
ul. Wrzesinska 70
62-025 Kostrzyn

Phone +48.61.6473830
Fax +48.61.6473839

Russian Federation

LLC "Sartorius ICR" and LLC "Biohit"
Uralskaya str. 4, Lit. B
199155, Saint-Petersburg

Phone +7.812.327.5.327
Fax +7.812.327.5.323

Spain Et Portugal

Sartorius Spain, S.A.
Avda. de la Industria, 32
Edificio PAYMA
28108 Alcobendas (Madrid)

Phone Spain +34.902.123.367
Phone Portugal +351.800.855.800
Fax Spain +34.91.358.96.23
Fax Portugal +351.800.855.799

Switzerland

Sartorius Mechatronics Switzerland AG
Ringstrasse 24a
8317 Tagelswangen (ZH)

Phone +41.44.746.50.00
Fax +41.44.746.50.50

U.K.

Sartorius UK Ltd.
Longmead Business Centre
Blenheim Road, Epsom
Surrey KT19 9QQ

Phone +44.1372.737159
Fax +44.1372.726171

Ukraine

LLC "Biohit"
Post Box 440 "B"
01001 Kiev, Ukraine

Phone +380.44.411.4918
Fax +380.50.623.3162

America

USA

Sartorius Corporation
5 Orville Drive, Suite 200
Bohemia, NY 11716

Phone +1.631.254.4249
Toll-free +1.800.635.2906
Fax +1.631.254.4253

Argentina

Sartorius Argentina S.A.
Int. A. Ávalos 4251
B1605ECS Munro
Buenos Aires

Phone +54.11.4721.0505
Fax +54.11.4762.2333

Brazil

Sartorius do Brasil Ltda
Avenida Senador Vergueiro 2962
São Bernardo do Campo
CEP 09600-000 – SP– Brasil

Phone +55.11.4362.8900
Fax +55.11.4362.8901

Canada

Sartorius Canada Inc.
2179 Dunwin Drive #4
Mississauga, ON L5L 1X2

Phone +1.905.569.7977
Toll-Free +1.800.668.4234
Fax +1.905.569.7021

Mexico

Sartorius de México S.A. de C.V.
Circuito Circunvalación Poniente
No. 149
Ciudad Satélite
53100, Estado de México
México

Phone +52.5555.62.1102
Fax +52.5555.62.2942

Asia | Pacific

Australia

Sartorius Australia Pty. Ltd.
Unit 5, 7-11 Rodeo Drive
Dandenong South Vic 3175

Phone +61.3.8762.1800
Fax +61.3.8762.1828

China

Sartorius Scientific
Instruments (Beijing) Co., Ltd.
33 Yu An Road, Airport Industrial Park
Zone B,
Shunyi District, Beijing 101300,
P.R.China

Phone +86.10.8042.6300
Fax +86.10.8042.6486

Hong Kong

Sartorius Hong Kong Ltd.
Unit 1012, Lu Plaza
2 Wing Yip Street
Kwun Tong
Kowloon, Hong Kong

Phone +852.2774.2678
Fax +852.2766.3526

India

Sartorius Weighing India Pvt. Ltd.
#69/2-69/3, NH 48, Jakkasandra,
Nelamangala Tq
562 123 Bangalore, India

Phone +91.80.4350.5250
Fax +91.80.4350.5253

Japan

Sartorius Japan K.K.
4th Fl., Daiwa Shinagawa North Bldg.
8-11, Kita-Shinagawa 1-chome
Shinagawa-ku, Tokyo, 140-0001 Japan

Phone +81.3.3740.5408
Fax +81.3.3740.5406

Malaysia

Sartorius Malaysia Sdn. Bhd
Lot L3-E-3B, Enterprise 4
Technology Park Malaysia
Bukit Jalil
57000 Kuala Lumpur, Malaysia

Phone +60.3.8996.0622
Fax +60.3.8996.0755

Singapore

Sartorius Singapore Pte. Ltd
1 Science Park Road,
The Capricorn, #05-08A,
Singapore Science Park II
Singapore 117528

Phone +65.6872.3966
Fax +65.6778.2494

South Korea

Sartorius Korea Ltd.
8th Floor, Solid Space B/D,
PanGyoYeok-Ro 220, Bundang-Gu
SeongNam-Si, GyeongGi-Do, 463-400

Phone +82.31.622.5700
Fax +82.31.622.5799

Thailand

Sartorius (Thailand) Co. Ltd.
129 Rama 9 Road,
Huaykwang
Bangkok 10310

Phone +66.2643.8361-6
Fax +66.2643.8367



◀ www.sartorius.com