



Technical data and operating instructions

Vivaspin[®] 6 and 20 ml

Vivaspin[®] 6 and 20 10K devices for in vitro diagnostic use

Vivaspin[®] Turbo 6 and 20 3K, 5K, 30K, 50K, 100K, 300K, 1000K and 0.2 µm devices for research use only; not for use in diagnostic procedures



Vivaspin® 6 and 20 ml – Introduction

Storage conditions | shelf life

Vivaspin® 6 and 20 ultrafiltration spin columns should be stored at 15–30°C. The devices should be used before the expiry date printed on the box.

Introduction

Vivaspin® concentrators are disposable ultrafiltration devices for the concentration and | or purification of biological samples. Vivaspin® 6 is suitable for sample volumes of 2–6 ml and the Vivaspin® 20 can handle samples up to 20 ml. Both products feature twin vertical membranes for unparalleled speed.

Vivaspin® 20 purification alternatives include a diafiltration cup that allows one step removal of salts and other contaminating micromolecules, and a gas pressure mode for increased flexibility and even faster processing.

The innovative design (US Patent No. 5,647,990, second patent pending), ease of use, speed and exceptional concentrate recoveries are the main features of the concentrators.

CE

The Vivaspin® 6 and 20 includes 9 different cutoffs (Molecular Weight Cutoff, MWCO):

- Vivaspin® 6 & 20 3K device: 3,000 MWCO
- Vivaspin® 6 & 20 5K device: 5,000 MWCO
- Vivaspin® 6 & 20 10K device: 10,000 MWCO
- Vivaspin® 6 & 20 30K device: 30,000 MWCO
- Vivaspin® 6 & 20 50K device: 50,000 MWCO
- Vivaspin® 6 & 20 100K device: 100,000 MWCO
- Vivaspin® 6 & 20 100K device: 300,000 MWCO
- Vivaspin® 6 & 20 100K device: 1000,000 MWCO
- Vivaspin® 6 & 20 100K device: 0.2 µm

Vivaspin® 6 & 20 10K filter devices are for in vitro diagnostic use and can be used to concentrate serum, urine, cerebrospinal fluid, and other body fluids prior to analysis.

Vivaspin® 6 & 20 3K, 5K, 30K, 50K, 100K, 300K, 1000K and 0.2 µm filter devices are for research use only and not for use in diagnostic procedures. The Vivaspin® Turbo 4 and 15 devices are supplied non-sterile and are for single use only.

Centrifugal Operation

Vivaspin® concentrators can be used in swing bucket or fixed angle rotors accepting standard conical bottom tubes. In a single spin, solutions can be concentrated in excess of 100 ×. Samples are typically concentrated in 10 to 30 minutes with macromolecular recoveries in excess of 95%.

The longitudinal membrane orientation and thin channel concentration chamber, provide optimum cross flow conditions even for particle laden solutions; the centrifugal force pulling particles and solids away from the membrane to the bottom of the device. Macromolecules collect in an impermeable concentrate pocket integrally moulded below the membrane surface, thereby eliminating the risk of filtration to dryness.

Pressurised Operation

When an appropriate centrifuge is unavailable, or for single sample processing, Vivaspin® 20 can be filled with up to 15 ml and pressurised for bench top concentration. For even faster processing, pressure can be combined with centrifugal force. “Pressure-Fugation” is particularly suitable for viscous samples such as serum, or when processing at low temperatures, and generally when minimum process time is essential.

Equipment Required

A. For use with centrifuge

1. Centrifuge with swing bucket or fixed angle rotor (minimum 25°).
2. Pasteur or fixed volume pipettes for sample delivery and removal.

Device	Carrier Required
Vivaspin® 6	15 ml/17 mm Ø
Vivaspin® 20	50 ml/30 mm Ø

B. For use with Pressure (Vivaspin® 20 only)

1. Vivaspin® 20 Pressure Head (Product No. VCA200).
2. Charge Valve for Pressure Head (Product No. VCA005).
3. Air Pressure Controller (Product No. VCA002) or equivalent pressure regulator

For use with Pressure and Centrifuge

1. All of the equipment shown in A. and B. above.

DOMINIQUE DUTSCHER SAS

Equipment Required

Equipment required	Vivaspin® 6		Vivaspin® 20	
Centrifuge				
Rotor type	Swing bucket	Fixed angle	Swing bucket	Fixed angle
Minimum rotor angle	–	25°	–	25°
Rotor cavity	To fit 15 ml (17 mm) conical bottom tubes		To fit 50 ml (30 mm) conical bottom tubes	

Optional pressure accessories for Vivaspin® 20

Air pressure controller (APC) complete with pressure gauge, regulator, over-pressure safety valve, female connector and 1 m extension line (4 mm pneumatic tubing) with male and female connectors and 1 m of 6 mm inlet tubing	Prod. no. VCA002
Charge valve	Prod. no. VCA005
VS20 pressure head	Prod. no. VCA200

Concentrate recovery

Pipette type	Fixed or variable volume	Fixed or variable volume
Recommended tip	Thin gel loader type	Thin gel loader type

Rotor compatibility

Please note: Vivaspin® 20 (30 mm × 116 mm) is designed to fit into rotors that can accommodate Falcon 50 ml conical bottom tubes, e.g. Beckman Allegra 25R with TS-5.1-500 swing-out rotor with BUC 5 buckets and 368327 adaptors; Beckman TA-10.250 25° fixed angle rotor with 356966 adaptors; Heraeus Multifuge 3 S-R with (Heraeus/Sorvall) 75006445 swing out rotor with 75006441 buckets and adaptors for Falcon 50 ml conical bottom tubes.

Operation

In Centrifuge VS6 Et 20

1. Select the most appropriate membrane cut-off for your sample. For maximum recovery select a MWCO at least 50% smaller than the molecular size of the species of interest.
2. Fill concentrator with up to maximum volumes shown in table 1. (Ensure screw closure is fully seated)
3. Insert assembled concentrator into centrifuge (when fixed angle rotors are used, angle concentrator so that the printed window faces upwards | outwards).
4. Centrifuge at speeds recommended in table 2, taking care not to exceed the maximum g force indicated by membrane type and MWCO
5. Once the desired concentration is achieved, (see table 3a and 3b for guide to concentration times), remove assembly and recover sample from the bottom of the concentrate pocket with a pipette.

Removing the Vivaspin® 6 body from the filtrate tube

The sleeve (seen from the end) is oval in cross section. The tube is round in cross section to give a tight fit to the sleeve. To release the tube from the sleeve, you must pinch the tube – to press it into an oval shape – before removing it with a twisting action.

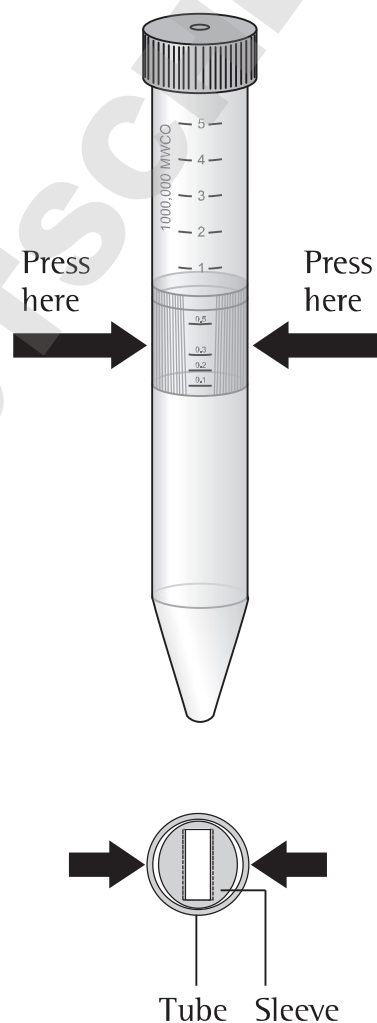

Using Gas Pressure (Vivaspin® 20 only)

1. Select appropriate membrane as above.
2. Fill concentrator (maximum 15 ml).
3. Fit Pressure Head (Prod. No. VCA200), and hand tighten to ensure an air tight seal.
4. Using Air Pressure Controller (APC), exchange the Female Coupling for the Charge Valve (Prod. No. VCA005), on the APC Extension line. Pressurise by pressing the Charge Valve into the inlet valve of the pressure head to achieve an air tight seal.
5. Either – stand assembly in a rack and allow to concentrate,
Or – for faster processing, insert assembled, pressurised concentrator into centrifuge and spin (see table 1 for spin speeds).
6. Once the desired concentration has been reached, (see table 3b for guide to concentration times), remove assembly and de-pressurise by unscrewing cap.
7. Extract concentrate using a pasteur or fixed volume pipette.

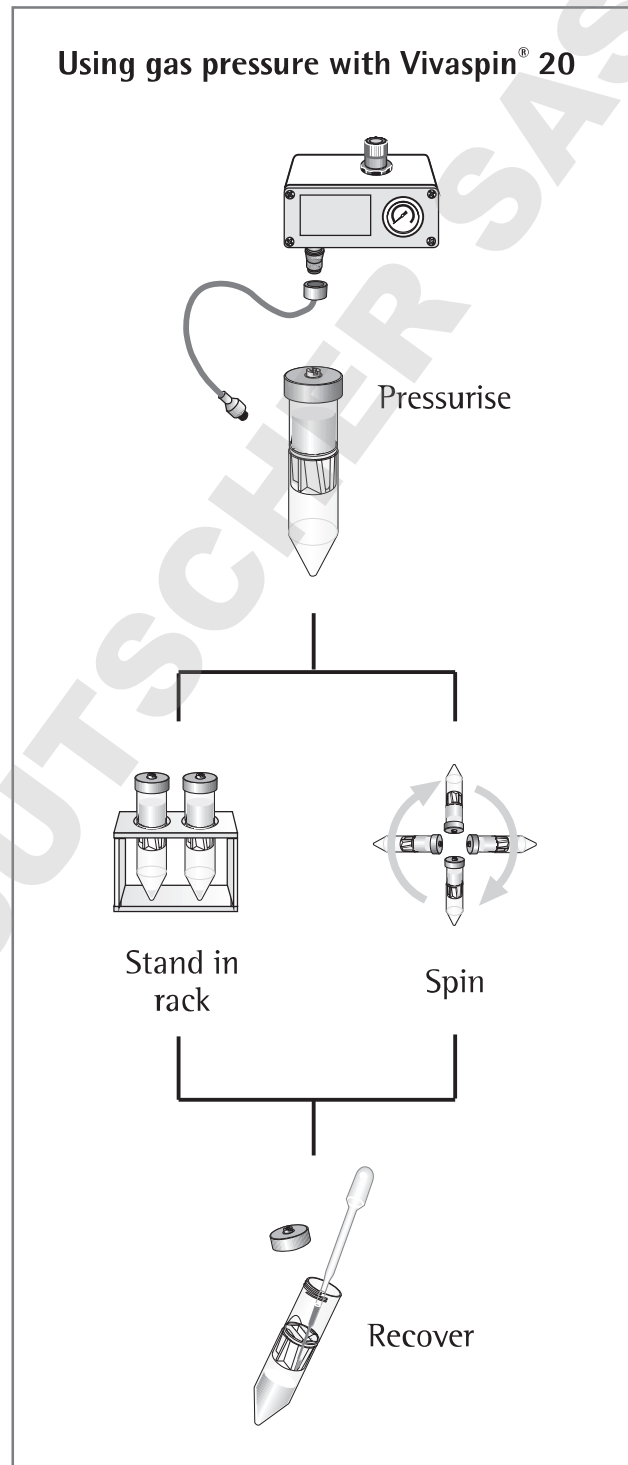

Desalting | Buffer Exchange

1. Concentrate sample to desired level.
2. Empty filtrate container.
3. Refill concentrator with an appropriate solvent.
4. Concentrate the sample again and repeat the process until the concentration of contaminating microsolutes is sufficiently reduced. Typically, 3 wash cycles will remove 99% of initial salt content.

Desalting with Vivaspin® 20

Salts and contaminants can be removed in a single step when using the special diafiltration cup available with the Vivaspin® 20. This is due to the constant washing action (constant volume diafiltration), of the buffer solution in the cup as it replaces solvent and salts passing through the ultrafiltration membrane.

1. Place 2 ml sample solution in the concentrator. (Larger volumes can be desalted by first concentrating down to 2 ml and decanting filtrate).
2. Empty filtrate container.
3. Insert diafiltration cup into concentrator and fill with 10 ml deionised water or buffer solution. Re-fit blue lid over the diafiltration cup.
4. Repeat concentration process; over 98% of salts will be removed in this step.
5. Remove diafiltration cup and recover concentrated and purified sample.

Vivaspin® 20 Diafiltration

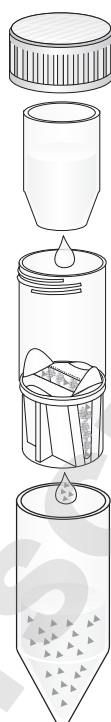

Diafiltration cup is filled with buffer solution (Product No: VSA005)

During concentration, solvent in sample is continuously replaced by fresh buffer solution.

Salts and contaminants are progressively cleared through membrane and into filtrate vessel

Technical Specifications

Table 1: Technical Specifications

	Vivaspin® 6	Vivaspin® 20
Concentrator capacity		
Swing bucket rotor	6 ml	20 ml
Fixed angle rotor	6 ml	14 ml
With pressure head	–	15 ml
Dimensions		
Total Length	122 mm	116 mm
	–	125 mm with pressure head
Width	17 mm	30 mm
Active membrane area	2.5 cm ²	6.0 cm ²
Hold up volume of membrane	<10 µl	<20 µl
Dead stop volume*	30 µl	50 µl
Materials of construction		
Concentrator body	Polycarbonate	Polycarbonate
Filtrate vessel	Polycarbonate	Polycarbonate
Concentrator cap	Polypropylene	Polypropylene
Pressure head	–	Acetal/aluminium
Membrane	Polyethersulfone	Polyethersulfone

Table 2: Recommended Spin Speed (xg)

Vivaspin® 6	Swing Bucket	Fixed Angle	
Membrane	max	max	
3–50,000 MWCO PES	4,000	10,000	
>100,000 MWCO PES	4,000	6,000	
Vivaspin® 20	Centrifuge	Pressure-Fuge	
Rotor	Swing Bucket	Fixed Angle	Swing Bucket (5 bar max)
Membrane	max	max	max
3–50,000 MWCO PES	5,000	8,000	3,000
>100–300,000 MWCO PES	3,000	6,000	2,000

* Dead stop volume as designed in moulding tool. This volume may vary depending on sample, sample concentration, operation temperature and centrifuge rotor.

Usage Tips

1. Flow Rate

Filtration rate is affected by several parameters, including MWCO, porosity, sample concentration, viscosity, centrifugal force and temperature. Expect significantly longer spin times for starting solutions with over 5% solids. When operating at 4°C, flow rates are approximately 1.5 times slower than at 25°C. Viscous solutions such as 50% glycerine will take up to 5 times longer to concentrate than samples in a predominantly buffer solution.

2. Pre-rinsing

Membranes fitted to Vivaspin® concentrators contain trace amounts of Glycerine and Sodium azide. Should these interfere with analysis they can be removed by rinsing fill volume of buffer solution or deionised water through the concentrator. Decant filtrate and concentrate before processing sample solution. If you do not want to use the pre-rinsed device immediately, store it in the refrigerator with buffer or water covering the membrane surface. Please do not allow the membrane to dry out.

3. Sterilisation of Polyethersulfone Membranes

Polyethersulfone membranes should not be autoclaved as high temperatures will substantially increase membrane MWCO. To sterilise, use a 70% ethanol solution or sterilising gas mixture.

4. Chemical Compatibility

Vivaspin® concentrators are designed for use with biological fluids and aqueous solutions. For chemical compatibility details, refer to table 4.

Performance Characteristics

Table 3a: Performance Characteristics Vivaspin® 6

Rotor	Time to concentrate up to 30x [min.] at 20°C and solute recovery %			
	Swing bucket		25° Fixed angle	
Start volume	6 ml		6 ml	
	Min.	Rec.	Min.	Rec.
Cytochrome c 0.25 mg/ml (12,400 MW)				
3,000 MWCO PES	–	–	90	97%
BSA 1.0 mg/ml (66,000 MW)				
5,000 MWCO PES	20	98%	12	98%
10,000 MWCO PES	13	98%	10	98%
30,000 MWCO PES	12	98%	9	97%
IgG 0.25 mg/ml (160,000 MW)				
30,000 MWCO PES	18	96%	15	95%
50,000 MWCO PES	17	96%	14	95%
100,000 MWCO PES	15	91%	12	91%
Latex beads 0.004% in DMEM +10% FCS (0.055 µm)				
300,000 MWCO PES	–	–	25	99%
Latex beads 0.004% in DMEM +10% FCS (0.24 µm)				
1,000,000 MWCO PES	–	–	4	99%
Yeast 1.0 mg/ml (<i>S. Cerevisiae</i>)				
0.2 µm PES	4	97%	3	97%

Table 3b: Performance Characteristics Vivaspin® 20

Mode	Time to concentrate up to 30x [min.] at 20°C and solute recovery %							
	Centrifuge		Centrifuge		Bench top		Press-fuge	
Rotor	Swing bucket		25° Fixed angle		Pressure		Swing bucket	
Start volume	20 ml		14 ml		10 ml		10 ml	
	Min.	Rec.	Min.	Rec.	Min.	Rec.	Min.	Rec.
Cytochrome c 0.25 mg/ml (12,400 MW)								
3,000 MWCO PES	110	97%	180	96%	60	96%	–	–
BSA 1.0 mg/ml (66,000 MW)								
5,000 MWCO PES	23	99%	29	99%	50	98%	14	98%
10,000 MWCO PES	16	98%	17	98%	32	97%	8	97%
30,000 MWCO PES	13	98%	15	98%	32	97%	8	97%
IgG 0.25 mg/ml (160,000 MW)								
30,000 MWCO PES	27	97%	20	95%	46	94%	13	97%
50,000 MWCO PES	27	96%	22	95%	46	93%	13	96%
100,000 MWCO PES	25	91%	20	90%	42	88%	12	94%
Latex beads 0.004% in DMEM +10% FCS (0.055 µm)								
300,000 MWCO PES	20	99%	35	99%	10	99%	–	–
Latex beads 0.004% in DMEM +10% FCS (0.24 µm)								
1,000,000 MWCO PES	4	99%	12	99%	4	99%		
Yeast 1.0 mg/ml (S. Cerevisiae)								
0.2 µm PES	15	95%	5	95%	20	95%	2	95%

Chemical Compatibility

Table 4: Chemical Compatibility (2hr contact time)

Solutions	PES	Solutions	PES
Compatible pH range	pH 1–9	Compatible pH range	pH 1–9
Acetic Acid (25.0%)	OK	Lactic Acid (5.0%)	OK
Acetone (10.0%)	NO	Mercaptoethanol (10 mM)	OK
Acetonitrile (10.0%)	NO	Methanol (60%)	?
Ammonium Hydroxide (5.0%)	?	Nitric Acid (10.0%)	OK
Ammonium Sulphate (saturated)	OK	Phenol (1.0%)	?
Benzene (100%)	NO	Phosphate Buffer (1.0 M)	OK
n-Butanol (70%)	OK	Polyethylene Glycol (10%)	OK
Chloroform (1.0%)	NO	Pyridine (100%)	?
Dimethyl Formamide (10.0%)	?	Sodium Carbonate (20%)	?
Dimethyl Sulfoxide (5.0%)	OK	Sodium Deoxycholate (5.0%)	OK
Ethanol (70.0%)	OK	Sodium Dodecylsulfate (0.1 M)	OK
Ethyl Acetate (100%)	NO	Sodium Hydroxide	NO
Formaldehyde (30%)	OK	Sodium Hypochlorite (200 ppm)	?
Formic Acid (5.0%)	OK	Sodium Nitrate (1.0%)	OK
Glycerine (70%)	OK	Sulfamic Acid (5.0%)	OK
Guanidine HCl (6 M)	OK	Tetrahydrofuran (5.0%)	NO
Hydrocarbons, aromatic	NO	Toluene (1.0%)	NO
Hydrocarbons, chlorinated	NO	Trifluoroacetic Acid (10%)	OK
Hydrochloric Acid (1 M)	OK	Tween ^{®*} 20 (0.1%)	OK
Imidazole (500 mM)	OK	Triton ^{®**} X-100 (0.1%)	OK
Isopropanol (70%)	OK	Urea (8 M)	OK

OK = Acceptable ? = Questionable NO = Not recommended

* Triton[®] is a registered trademark of Union Carbide Corp.

** Tween[®] is a registered trademark of ICI Americas Inc.

Ordering Information











Vivaspin® 6 Polyethersulfone	Qty per box	Prod. No.
3,000 MWCO	25	VS0691
3,000 MWCO	100	VS0692
5,000 MWCO	25	VS0611
5,000 MWCO	100	VS0612
10,000 MWCO	25	VS0601
10,000 MWCO	100	VS0602
30,000 MWCO	25	VS0621
30,000 MWCO	100	VS0622
50,000 MWCO	25	VS0631
50,000 MWCO	100	VS0632
100,000 MWCO	25	VS0641
100,000 MWCO	100	VS0642
300,000 MWCO	25	VS0651
300,000 MWCO	100	VS0652
1,000,000 MWCO	25	VS0661
1,000,000 MWCO	100	VS0662
0.2 µm	25	VS0671
0.2 µm	100	VS0672
Starter pack (5 of each 5 K, 10 K, 30 K, 50 K, 100 K)	25	VS06S1

Vivaspin® 20 Polyethersulfone	Qty per box	Prod. no.
3,000 MWCO	12	VS2091
3,000 MWCO	48	VS2092
5,000 MWCO	12	VS2011
5,000 MWCO	48	VS2012
10,000 MWCO	12	VS2001
10,000 MWCO	48	VS2002
30,000 MWCO	12	VS2021
30,000 MWCO	48	VS2022
50,000 MWCO	12	VS2031
50,000 MWCO	48	VS2032
100,000 MWCO	12	VS2041
100,000 MWCO	48	VS2042
300,000 MWCO	12	VS2051
300,000 MWCO	48	VS2052
1,000,000 MWCO	12	VS2061
1,000,000 MWCO	48	VS2062
0.2 µm	12	VS2071
0.2 µm	48	VS2072
Starter pack (2 of each 5 K, 10 K, 30 K, 50 K, 100 K, 0.2 µm)	12	VS20S1

Vivaspin® 20 accessories	Qty per box	Prod. no.
Air pressure controller (APC)	1	VCA002
Charge valve for pressure head	1	VCA005
Diafiltration cups	12	VSA005
Female connector	1	VCA010
Male connector	1	VCA011
4 mm OD pneumatic tube (3 m)	1	VCA012
Vivaspin® 20 pressure head	1	VCA200

In Vitro Diagnostic Product Labeling

The following table defines the symbols found on Vivaspin® 6 & 20 10K device labels.

Symbol	Definition	Symbol	Definition
	In vitro diagnostic medical device		Date of manufacture
	Catalogue number		Manufacturer
	Do not reuse		Temperature limitation
	Use by		Non-sterile product
	Batch code		CE conformity marking

Made in UK
Sartorius Stedim Lab Ltd.
Unit 6, Stonedale Road,
Stonehouse, Gloucestershire,
GL10 3RQ. UK

www.sartorius-stedim.com

Copyright by
Sartorius Lab Instruments
GmbH & Co. KG, Goettingen,
Germany.

All rights reserved. No part
of this publication may
be reprinted or translated in
any form or by any means
without the prior written
permission of Sartorius Lab
Instruments GmbH & Co. KG.
The status of the information,
specifications and illustrations
in this manual is indicated
by the date given below.
Sartorius Lab Instruments
GmbH & Co. KG reserves the
right to make changes to the
technology, features,
specifications and design of the
equipment without notice.

Status:
November 2015,
Sartorius Lab Instruments
GmbH & Co. KG,
Goettingen, Germany

Specifications subject to change without
notice. Copyright Sartorius Stedim Biotech
GmbH. Printed in the EU on paper
bleached without chlorine.
Publication No.: SLU6092-e151109
Ver. 11 | 2015