

## Ultrafiltration Family



# Vivaspin Ultrafiltration Family – Sample Concentration up to 20 ml Initial Volume

With their broad range of volume capacities and MWCOs, Vivaspin centrifugal concentrators offer the optimal solution to any concentration or buffer exchange application.

Due to their particular vertical membrane design they achieve highest flow rates and recoveries.

The patented dead-stop technology allowing direct recovery of the concentrate without further respin assures incomparably safe sample handling and convenience.



Vivaspin 500

500  $\mu$ l\* – 5  $\mu$ l\*\*



Vivaspin 2

2 ml – 8  $\mu$ l



Vivaspin 6

6 ml – 30  $\mu$ l



Vivaspin 15R

15 ml – 30  $\mu$ l

## Vivaspin Applications

- Concentration of biological samples containing antigens, antibodies or enzymes
- Concentration of diluted protein samples from chromatography eluates
- Desalting or diafiltration | buffer exchange
- Sample concentration for crystallization and NMR spectroscopy
- Removal of very small or large contaminants

## Features

- Vertical, large membrane design
- Integrated Dead-Stop-Volume
- Low-binding materials
- No Re-spin necessary
- Broad volume range from 0.5 – 20 ml
- Wide MWCO range from 2 kDa – 0.2  $\mu$ m

## Benefits

- Fast, minimal membrane blocking
- No risk (to concentrate to dryness)
- High recovery
- Easy handling, fast
- High volume flexibility
- High MWCO flexibility

## Features

- Vivaspin Turbo range for fastest concentration speed and highest recoveries
- Angular dead-stop pocket in Vivaspin Turbo range

## Benefits

- Saving time combined with virtually complete concentrate recovery
- Easy and complete concentrate recovery due to pipette friendly access



Vivaspin 20

20 ml – 50  $\mu$ l



Vivaspin Turbo 4

4 ml – 30  $\mu$ l



Vivaspin Turbo 15

15 ml – 100  $\mu$ l



\* Volume

\*\* Dead stop vol.

# Vivaspin Ultrafiltration Family – Sample Concentration up to 20 ml Initial Volume

With their broad range of volume capacities and MWCOs, Vivaspin centrifugal concentrators offer the optimal solution to any concentration or buffer exchange application.

Due to their particular vertical membrane design they achieve highest flow rates and recoveries.

The patented dead-stop technology allowing direct recovery of the concentrate without further respin assures incomparably safe sample handling and convenience.



Vivaspin 500

500  $\mu$ l\* – 5  $\mu$ l\*\*



Vivaspin 2

2 ml – 8  $\mu$ l



Vivaspin 6

6 ml – 30  $\mu$ l



Vivaspin 15R

15 ml – 30  $\mu$ l

## Vivaspin Applications

- Concentration of biological samples containing antigens, antibodies or enzymes
- Concentration of diluted protein samples from chromatography eluates
- Desalting or diafiltration | buffer exchange
- Sample concentration for crystallization and NMR spectroscopy
- Removal of very small or large contaminants

## Features

- Vertical, large membrane design
- Integrated Dead-Stop-Volume
- Low-binding materials
- No Re-spin necessary
- Broad volume range from 0.5 – 20 ml
- Wide MWCO range from 2 kDa – 0.2  $\mu$ m

## Benefits

- Fast, minimal membrane blocking
- No risk (to concentrate to dryness)
- High recovery
- Easy handling, fast
- High volume flexibility
- High MWCO flexibility

## Ordering Information

### Vivaspin – PES Membrane

MWCO	3 kDa	5 kDa <sup>1)</sup>	10 kDa <sup>1)</sup>	30 kDa <sup>1)</sup>	50 kDa <sup>1)</sup>	100 kDa <sup>1)</sup>	300 kDa	1,000 kDa	0.2 µm	<sup>1)</sup> 5 of each	
<b>Product</b>	<b>Volume</b>	<b>Dead-stop vol.</b>									
Vivaspin 500	0.5 ml	5 µl	V50111 (25)	V50101 (25)	V50121 (25)	V50131 (25)	V50141 (25)	V50151 (25)	V50161 (25)	V50171 (25)	V50151 (25)
			V50192 (100)	V50102 (100)	V50122 (100)	V50132 (100)	V50142 (100)	V50152 (100)	V50162 (100)	V50172 (100)	V50152 (100)
Vivaspin 2	2 ml	8 µl	V50291 (25)	V50201 (25)	V50221 (25)	V50231 (25)	V50241 (25)	V50251 (25)	V50261 (25)	V50271 (25)	V50251 (25)
			V50292 (100)	V50202 (100)	V50222 (100)	V50232 (100)	V50242 (100)	V50252 (100)	V50262 (100)	V50272 (100)	V50252 (100)
Vivaspin Turbo 4	4 ml	30 µl	V504191 (25)	V504101 (25)	V504121 (25)	V504131 (25)	V504141 (25)				
			V504192 (100)	V504102 (100)	V504122 (100)	V504132 (100)	V504142 (100)				
Vivaspin 6	6 ml	30 µl	V50691 (25)	V50601 (25)	V50621 (25)	V50631 (25)	V50641 (25)	V50651 (25)	V50661 (25)	V50671 (25)	V50651 (25)
			V50692 (100)	V50602 (100)	V50622 (100)	V50632 (100)	V50642 (100)	V50652 (100)	V50662 (100)	V50672 (100)	V50652 (100)
Vivaspin Turbo 15	15 ml	100 µl	V515191	V515101 (12)	V515121 (12)	V515131 (12)	V515141 (12)				
			V515191	V515102 (48)	V515122 (48)	V515132 (48)	V515142 (48)				
Vivaspin 20	20 ml	50 µl	V52091 (12)	V52011 (12)	V52021 (12)	V52031 (12)	V52041 (12)	V52051 (12)	V52061 (12)	V52071 (12)	V52051 (12)
			V52092 (48)	V52012 (48)	V52022 (48)	V52032 (48)	V52042 (48)	V52052 (48)	V52062 (48)	V52072 (48)	V52052 (48)

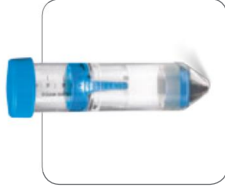

Vivaspin 20  
20 ml – 50 µl

### Vivaspin – Hydrosart® Membrane

MWCO	2 kDa	5 kDa	10 kDa	30 kDa
<b>Product</b>	<b>Volume</b>	<b>Dead-stop vol.</b>		
Vivaspin 2	2 ml	8 µl	V502H91 (25)*	V502H01 (25)
			V502H92 (100)	V502H02 (100)
Vivaspin 15R	15 ml	30 µl	V515RH91 (12)	V515RH01 (12)
			V515RH92 (48)	V515RH02 (48)

### Vivaspin – CTA Membrane

MWCO	5 kDa	10 kDa	20 kDa
<b>Product</b>	<b>Volume</b>	<b>Dead-stop vol.</b>	
Vivaspin 2	2 ml	8 µl	V502U1 (25)
			V502U2 (100)

### Vivaspin Additional Devices

Product Description	Qty per Box	Order No.
Vivaspin 20 – Diafiltration cups	12	V5A005

\* Volume  
\*\* Dead-stop vol.  
(Qty per box in parenthesis)



# Vivacell Pressure Units – Sample Concentration up to 250 ml Initial Volume

Vivacell – Put your proteins under pressure! Pressurization, centrifugation or both – the choice is yours. Sartorius offers the Vivacell product range of pressurizable and centrifugal concentrators for sample volumes from 20 ml to 250 ml. The patented vertical membrane design guarantees highest performance and unmatched flexibility.

Vivacell products are unique and innovative concentrators that can be pressurized and centrifuged, or a combination of both for fast and safe sample concentration.

Benefit from our patented dead-stop technology, high process speeds and direct concentrate recovery without the need for reverse spinning!

## Vivacell Family

### Vivacell 70 – Centrifugation | Pressure

MWCO	Vivacell 70; Volume = 70 ml; Dead stop vol. = 150 µl
5 kDa	VS6011 (2)*, VS6012 (10)
10 kDa	VS6001 (2), VS6002 (10)
30 kDa	VS6021 (2), VS6022 (10)
50 kDa	VS6031 (2), VS6032 (10)
100 kDa	VS6041 (2), VS6042 (10)
0.2 µm	VS6071 (2), VS6072 (10)



### Vivacell 100 – Centrifugation | Pressure

MWCO	Vivacell 100; Volume = 100 ml; Dead stop vol. = 350 µl
5 kDa	VC1011 (2), VC1012 (10)
10 kDa	VC1001 (2), VC1002 (10)
30 kDa	VC1021 (2), VC1022 (10)
50 kDa	VC1031 (2), VC1032 (10)
100 kDa	VC1041 (2), VC1042 (10)
300 kDa	VC1051 (2), VC1052 (10)
1,000 kDa	VC1061 (2), VC1062 (10)
0.2 µm	VC1071 (2), VC1072 (10)



### Vivacell 250 – Pressure

MWCO	Vivacell 250; Volume = 250 ml; Dead stop vol. = 600 µl
5 kDa	VC2511 (5)
10 kDa	VC2501 (5)
30 kDa	VC2521 (5)
50 kDa	VC2531 (5)
100 kDa	VC2541 (5)
0.2 µm	VC2571 (5)



\* (Qty per box in parenthesis)

## Vivacell – Accessories for Different Applications

### APC

Description	Qty per Box	Order No.
<b>Air Pressure Controller</b>		
Includes pressure gauge, regulator, over-pressure safety valve, female connector and 1 m extension line (4 mm pneumatic tubing) with connectors and inlet-tubing	1	VCA002

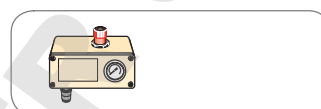

### Vivacell 70

Description	Qty per Box	Order No.
<b>Centrifugation</b>		
Vivacell centrifuge bottle-standard caps – swing out rotor	4	VSA003
Modified caps with centrifuge bottle – fixed angle rotor	2	VCA004
<b>Pressurize &amp; Pressure-shake</b>		
Female connector	1	VCA010
Male connector	1	VCA011
4 mm pneumatic tubing	1	VCA012
Pressure head with reservoir and filtrate bottle	1	VCA700
<b>Pressure-fugea</b>		
Charge valve for pressure-fuge head	1	VCA005
Vivacell replacement seals for pressure-fuge head	10	VCA007
Female connector	1	VCA010
Male connector	1	VCA011
4mm pneumatic tubing	1	VCA012
Pressure-fuge head	2	VCA701

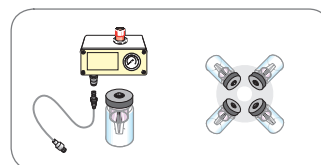
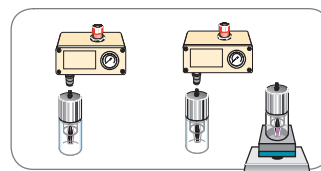
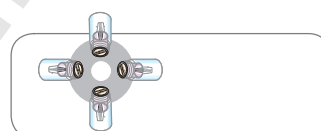

### Vivacell 100

Description	Qty per Box	Order No.
<b>Pressurize &amp; Pressure-shake</b>		
Sanoprene replacement seals	10	VCA014
Female connector	1	VCA010
Male connector	1	VCA011
4 mm pneumatic tubing	1	VCA012
Pressure head with replacement seals (5)	1	VCA800

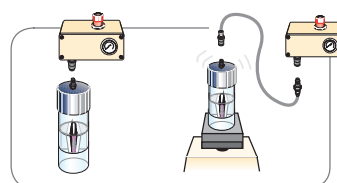

### Vivacell 250

Description	Qty per Box	Order No.
<b>Pressurize &amp; Pressure-shake</b>		
Replacement pressure indicator	1	VCA008
Vivacell maintenance kit (sample reservoir, filtrate container and O-ring seals)	1	VCA009
Female connector	1	VCA010
Male connector	1	VCA011
4 mm pneumatic tubing	1	VCA012
Replacement pressure head & screw closure	1	VCA015
Vivacell 250 complete with accessories	1	VCA250
Vivacell 250 starter kit	5	VC25S1

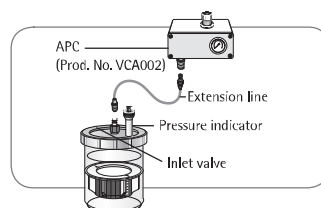

# Vivaflow Crossflow Cassettes – Sample Concentration up to 5 l

Plug and Play Convenience – Vivaflow units are ease to use, and provide an optimal performance, flexibility and economy which is unrivalled by any crossflow system on the market for laboratory needs. The devices are easy to set up and need only a standard peristaltic pump to operate.

## Vivaflow Setup

### 100 ml to 3 Liters

**Vivaflow 50** is a disposable, modular crossflow device, which can be easily scaled up to 6 units that run both in parallel and in series. Vivaflow 50 saves regeneration time and is the economical choice for concentration and buffer exchange of 0.1 ml to 3 l samples containing proteins, viruses and nanoparticles.

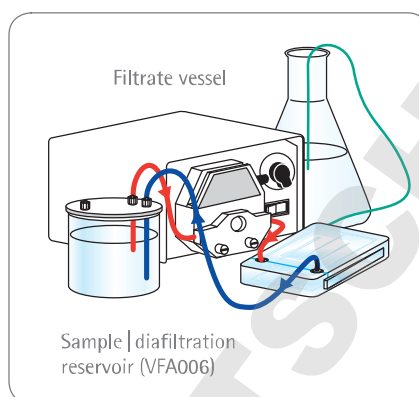

Vivaflow 50  
Single module

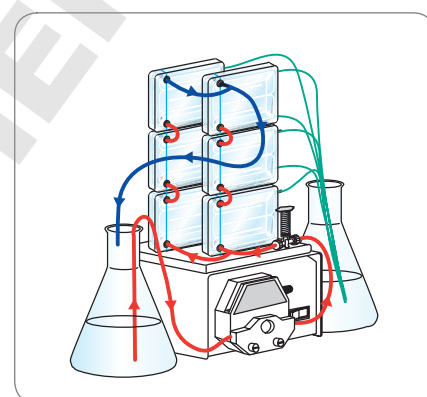

Vivaflow 50  
Multiple modules

### 100 ml to 1 Liter

**Vivaflow 50R** is a reusable crossflow device featuring a unique, low-binding modified regenerated cellulose membrane, Hydrosart<sup>®</sup>. Therefore, it is the ideal choice for concentrating expensive samples like viruses and antibodies. Vivaflow 50R can be scaled up with one additional unit to increase the flow speed for concentrating initial sample volumes of up to 1 l.

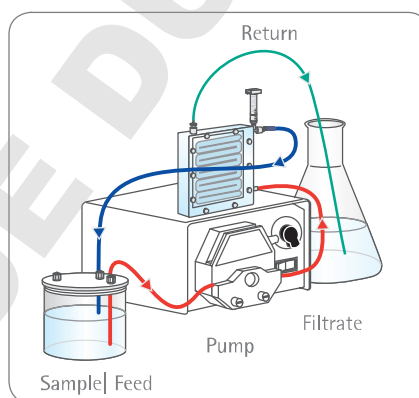

Vivaflow 50R  
Single module

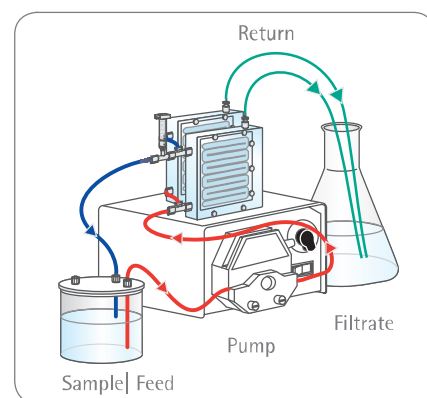

Vivaflow 50R  
Two modules

### 0.5 to 5 Liters

**Vivaflow 200**, like Vivaflow 50R, is a reusable crossflow device, but is available in a choice of membranes: modified regenerated cellulose, Hydrosart<sup>®</sup> and PES. This device is perfect for concentrating expensive samples like viruses and antibodies. Vivaflow 200 can be scaled up with one additional unit to increase the flow speed for concentrating initial sample volumes of up to 5 l.

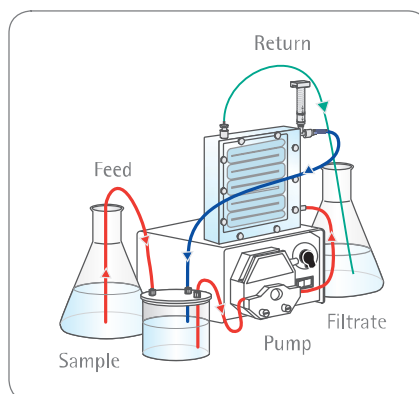

Vivaflow 200  
Single module

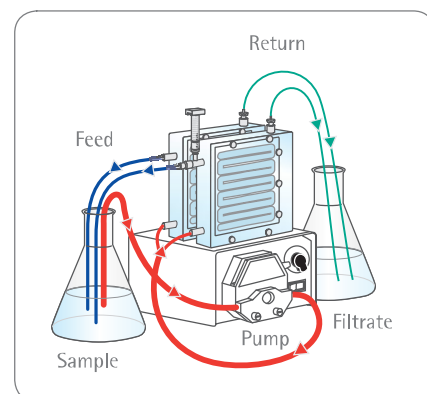

Vivaflow 200  
Two modules



## Vivaflow Applications

- Antibody | recombinant protein concentration | diafiltration in biopharma research
- Concentration of small production lots of proteins for diagnostic purposes
- Concentration of viruses from cell culture supernatants or of environmental samples
- Nanoparticle concentration

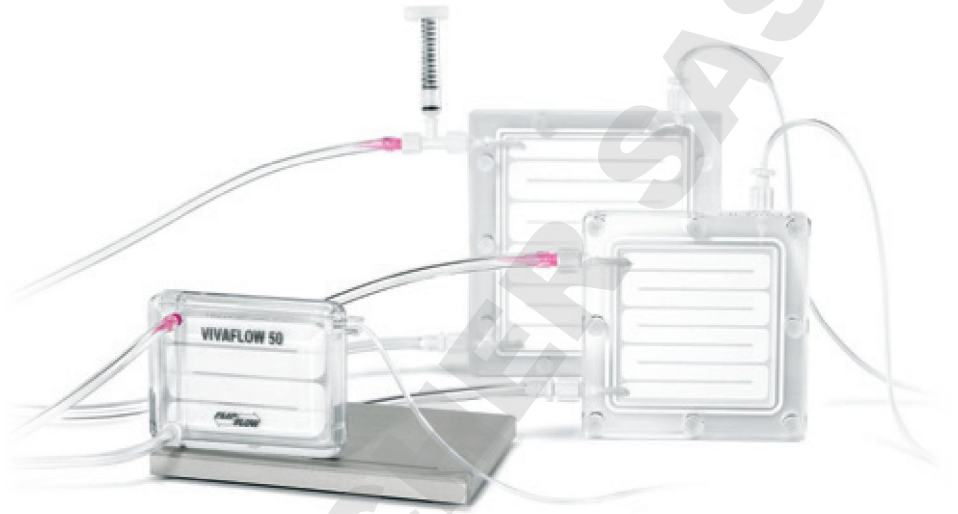

## Ordering Information

### Vivaflow – PES Membrane

MWCO			3 kDa	5 kDa	10 kDa	30 kDa	50 kDa	100 kDa	1000 kDa	0.2 µm
Product	Volume**	Min vol.								
Vivaflow 50	3 l	10 ml	VF05P9 (2)*	VF05P1 (2)*	VF05P0 (2)	VF05P2 (2)	VF05P3 (2)	VF05P4 (2)	VF05P6 (2)	VF05P7 (2)
Vivaflow 200	5 l	20 ml	VF20P9 (1)	VF20P1 (1)	VF20P0 (1)	VF20P2 (1)	VF20P3 (1)	VF20P4 (1)		VF20P7 (1)

### Vivaflow – RC Membrane

MWCO			100 kDa
Product	Volume**	Min vol.	
Vivaflow 50	3 l	10 ml	VF05C4 (2)*

### Vivaflow – Hydrosart® Membrane

MWCO			2 kDa	5 kDa	10 kDa	30 kDa	100 kDa	
Product	Volume**	Min vol.						
Vivaflow 50R	1 l	10 ml			VF05H1	VF05H0	VF05H2	VF05H4
Vivaflow 200	5 l	20 ml	VF 20H9	VF20H1	VF20H0	VF20H2	VF20H4	

### Vivaflow – Complete System (Pump, Easy Load Pump Head & Tubing)

Product Description	Order No.
Vivaflow 50	VFS504
Vivaflow 50R   200	VFS204

\* (Qty per box in parenthesis)

\*\* Volume refers to maximal recommended volume with multiple units

# Sales and Service Contacts

For further contacts, visit [www.sartorius.com](http://www.sartorius.com)

## Europe

### Germany

Sartorius Lab Instruments  
GmbH & Co. KG  
Weender Landstrasse 94–108  
37075 Goettingen

Phone +49.551.308.0  
Fax +49.551.308.3289

### France Et Suisse Romande

Sartorius France  
2, rue Antoine Laurent de Lavoisier  
ZA de la Gaudriée  
91410 Dourdan

Phone +33.1.70.62.50.00  
Fax +33.1.64.59.76.39

### Austria

Sartorius Austria GmbH  
Franzosengraben 12  
1030 Vienna

Phone +43.1.7965760.0  
Fax +43.1.7965760.24

### Belgium

Sartorius Belgium N.V.  
Leuvensesteenweg, 248/B  
1800 Vilvoorde

Phone +32.2.756.06.71  
Fax +32.2.253.45.95

### Finland & Baltics

Sartorius Biohit Liquid Handling Oy  
Laippatie 1  
00880 Helsinki

Phone +358.9.755.951  
Fax +358.9.755.95.200

### Hungary

Sartorius Hungária Kft.  
Kagyló u. 5.  
2092 Budakeszi

Phone +3623.457.227  
Fax +3623.457.147

### Ireland

Sartorius Ireland Ltd.  
Unit 41, The Business Centre  
Stadium Business Park  
Ballycoolin Road  
Dublin 11

Phone +353.1.8089050  
Fax +353.1.8089388

### Italy

Sartorius Italy S.r.l.  
Viale A. Casati, 4  
20835 Muggiò (MB)

Phone +39.039.4659.1  
Fax +39.039.4659.88

### Netherlands

Sartorius Netherlands B.V.

Phone +31.30.60.53.001  
Fax +31.30.60.52.917

[info.netherlands@sartorius.com](mailto:info.netherlands@sartorius.com)

### Poland

Sartorius Poland sp.z o.o.  
ul. Wrzesinska 70  
62-025 Kostrzyn

Phone +48.61.6473830  
Fax +48.61.6473839

### Russian Federation

LLC "Sartorius ICR" and LLC "Biohit"  
Uralskaya str. 4, Lit. B  
199155, Saint-Petersburg

Phone +7.812.327.5.327  
Fax +7.812.327.5.323

### Spain Et Portugal

Sartorius Spain, S.A.  
Avda. de la Industria, 32  
Edificio PAYMA  
28108 Alcobendas (Madrid)

Phone Spain +34.902.123.367  
Phone Portugal +351.800.855.800  
Fax Spain +34.91.358.96.23  
Fax Portugal +351.800.855.799

### Switzerland

Sartorius Mechatronics Switzerland AG  
Ringstrasse 24a  
8317 Tagelswangen (ZH)

Phone +41.44.746.50.00  
Fax +41.44.746.50.50

### U.K.

Sartorius UK Ltd.  
Longmead Business Centre  
Blenheim Road, Epsom  
Surrey KT19 9QQ

Phone +44.1372.737159  
Fax +44.1372.726171

### Ukraine

LLC "Biohit"  
Post Box 440 "B"  
01001 Kiev, Ukraine

Phone +380.44.411.4918  
Fax +380.50.623.3162

## America

### USA

Sartorius Corporation  
5 Orville Drive, Suite 200  
Bohemia, NY 11716

Phone +1.631.254.4249  
Toll-free +1.800.635.2906  
Fax +1.631.254.4253

### Argentina

Sartorius Argentina S.A.  
Int. A. Ávalos 4251  
B1605ECS Munro  
Buenos Aires

Phone +54.11.4721.0505  
Fax +54.11.4762.2333

### Brazil

Sartorius do Brasil Ltda  
Avenida Senador Vergueiro 2962  
São Bernardo do Campo  
CEP 09600-000 – SP– Brasil

Phone +55.11.4362.8900  
Fax +55.11.4362.8901

### Canada

Sartorius Canada Inc.  
2179 Dunwin Drive #4  
Mississauga, ON L5L 1X2

Phone +1.905.569.7977  
Toll-Free +1.800.668.4234  
Fax +1.905.569.7021

### Mexico

Sartorius de México S.A. de C.V.  
Circuito Circunvalación Poniente  
No. 149  
Ciudad Satélite  
53100, Estado de México  
México

Phone +52.5555.62.1102  
Fax +52.5555.62.2942

## Asia | Pacific

### Australia

Sartorius Australia Pty. Ltd.  
Unit 5, 7-11 Rodeo Drive  
Dandenong South Vic 3175

Phone +61.3.8762.1800  
Fax +61.3.8762.1828

### China

Sartorius Scientific  
Instruments (Beijing) Co., Ltd.  
33 Yu An Road, Airport Industrial Park  
Zone B,  
Shunyi District, Beijing 101300,  
P.R.China

Phone +86.10.8042.6300  
Fax +86.10.8042.6486

### Hong Kong

Sartorius Hong Kong Ltd.  
Unit 1012, Lu Plaza  
2 Wing Yip Street  
Kwun Tong  
Kowloon, Hong Kong

Phone +852.2774.2678  
Fax +852.2766.3526

### India

Sartorius Weighing India Pvt. Ltd.  
#69/2-69/3, NH 48, Jakkasandra,  
Nelamangala Tq  
562 123 Bangalore, India

Phone +91.80.4350.5250  
Fax +91.80.4350.5253

### Japan

Sartorius Japan K.K.  
4th Fl., Daiwa Shinagawa North Bldg.  
8-11, Kita-Shinagawa 1-chome  
Shinagawa-ku, Tokyo, 140-0001 Japan

Phone +81.3.3740.5408  
Fax +81.3.3740.5406

### Malaysia

Sartorius Malaysia Sdn. Bhd  
Lot L3-E-3B, Enterprise 4  
Technology Park Malaysia  
Bukit Jalil  
57000 Kuala Lumpur, Malaysia

Phone +60.3.8996.0622  
Fax +60.3.8996.0755

### Singapore

Sartorius Singapore Pte. Ltd  
1 Science Park Road,  
The Capricorn, #05-08A,  
Singapore Science Park II  
Singapore 117528

Phone +65.6872.3966  
Fax +65.6778.2494

### South Korea

Sartorius Korea Ltd.  
8th Floor, Solid Space B/D,  
PanGyoYeok-Ro 220, Bundang-Gu  
SeongNam-Si, GyeongGi-Do, 463-400

Phone +82.31.622.5700  
Fax +82.31.622.5799

### Thailand

Sartorius (Thailand) Co. Ltd.  
129 Rama 9 Road,  
Huaykwang  
Bangkok 10310

Phone +66.2643.8361-6  
Fax +66.2643.8367



◀ [www.sartorius.com](http://www.sartorius.com)