



Precision immersion thermostats, baths & circulators

Optima TX150 & TXF200

Operating Manual



EN



FR



DE



IT



ES

Grant Instruments, based near Cambridge, England is a world leader in the manufacture and design of equipment for sample preparation, scientific analysis, data acquisition and data analysis providing solutions to the global scientific and industrial markets.

Standards Compliance and Quality

Grants' brand and reputation are based around quality, reliability and accuracy. We ensure our products stringently meet all necessary international safety standards. We pay particular attention to the safety testing of products and remain at the forefront of the product safety standard for laboratory equipment IEC 61010-1. The company is committed to operating its safety test laboratory in accordance with the requirements of ISO 17025.

Grant operates a Quality Management System that complies with the requirements of BS EN ISO 9001:2008.

Beyond compliance to the standard, Grant is committed to continually improving in everything we do; with particular emphasis on understanding what matters to our customers and suppliers, and designing our systems and work to meet their needs.

If you have any feedback on Grant's products or services we would like to hear from you. Please send all feedback to:

Quality Manager
Grant Instruments (Cambridge) Ltd
Shepreth
Cambridgeshire
SG8 6GB
UK

Tel: +44 (0) 1763 260 811
Fax: +44 (0) 1763 262 410
E-mail: feedback@grantinstruments.com

Contents

Contents	2
1.0 Use of products	4
2.0 How to use this operating manual	4
3.0 Safety information	5
3.1 Safety compliance	5
3.2 Safety symbols	5
3.3 Safety warnings	5
4.0 Operating instructions	6
4.1 Unpacking instructions	6
4.2 Fitting controller to ST baths	6
4.3 Fitting the controller to P baths	7
4.4 Fitting the controller to custom baths	7
4.5 Removing the controller from the bridge plate	8
4.6 Recommended liquids	8
4.7 Installation	9
4.8 Electrical supply	9
4.9 Using accessory cooling (C1G, C2G, CW5)	9
5.0 Operating procedures	10
5.1 Operation	10
5.1.1 Liquid level	10
5.1.2 Operation above 60°C	10
5.1.3 Operation at low temperatures	10
5.1.4 Using the pump	10
5.1.5 Using the switch over relay output	11
5.1.6 Emptying the ST baths	12
5.1.7 Setting up and switching on	12
5.1.8 Power loss	12
5.2 Using the TX150 & TXF200	13
5.2.1 Front panel controls	13
5.2.2 Rear panel connections	14
5.2.3 Communications ports	14
5.2.4 Switched relay port	14
5.2.5 External probe input	14
5.2.6 Setting the over-temperature thermostat	15
5.2.7 Display. Explanation of home screen icons.	15
5.2.8 Description of user interface and controls	16
5.2.9 Setting the control temperature	16
5.2.10 Setting a pump speed (TXF200 only)	16
5.2.11 Running a bath preset	17
5.2.12 Running a countdown timer	17
5.2.13 Running a program	18
5.2.14 Activating standby mode	19
5.2.15 Accessing the settings menu	19
5.3 Viewing, editing and saving settings	21
5.3.1 Configuring a preset	21
5.3.2 Creating a program (TXF200 only)	22
5.3.3 Editing a program (TXF200 only)	24
5.3.4 Selecting a liquid type	25
5.3.5 Selecting a temperature probe type	26
5.3.6 Configuring high and low temperature alarms	27
5.3.7 Setting the buzzer volume level	30
5.3.8 Selecting a language	30
5.3.9 Relay test and configuration	31
5.3.10 Display rounding	32

5.4	Completing a calibration	33
5.4.1	Restoring factory calibration settings	34
6.0	Technical specifications	35
6.1	Operating conditions	35
6.2	Electrical details	35
6.3	Product performance	35
6.4	Bath accessories information	35
7.0	Technical Tips	36
7.1	Which water should you use in your bath?	36
7.2	How to prevent rust in water baths	36
7.3	How to prevent algae and bacteria	37
8.0	Warranty information	37
9.0	Maintenance and service	37
9.1	Routine maintenance	37
9.2	Cleaning	37
9.3	Fuses	38
9.4	Replacing the mains cord	38
9.5	Routine safety tests	38
9.6	Service	38
10.0	Optional accessories	38
11.0	Troubleshooting	39
12.0	Contact Grant Instruments	42
13.0	Compliance	42

1.0 Use of products

The following products are covered by this operating manual:

- TX150 & TX150L
- TXF200 & TXF200L

The products listed above are precision immersion thermostats to be used with baths or circulators designed for indoor laboratory use by a professional user.

2.0 How to use this operating manual

This operating manual will allow you to unpack, set-up and operate this immersion thermostat correctly and safely. Important safety information, symbols and warnings are listed below and should be read carefully. Section 4 gives information about how to unpack and install the product correctly. Section 5 gives operating information for the TX150 & TXF200 models. Product technical specifications and tips are provided in sections 6 and 7. The warranty for this product is for THREE YEARS and is detailed in section 8 and should be registered by completing the on-line registration form at www.grantinstruments.com.

If there is a technical matter that this operating manual does not address, or any other question concerning this product, please contact Grant Instruments or your local distributor, who will be able to provide any additional information.

3.0 Safety information

3.1 Safety compliance

Grant immersion thermostats meet the requirements of international safety standard IEC 61010: Safety requirements for electrical equipment for measurement, control, and laboratory use. They also comply with the equivalent national standards including:

EN 61010-2-010
UL 61010A-2-010
CAN/CSA-C22.2 NO. 61010-2-010-04.

3.2 Safety symbols

The symbols below are marked on the equipment and throughout this manual to indicate:



Caution: Surfaces and heat transfer liquid can be hot during and after use.



Read this manual before using the bath.



Important safety warning.

3.3 Safety warnings



Read the whole of these instructions. Safety may be impaired if they are not followed.



For the TX150/TXF200 only use liquids specified in these operating instructions, within the specified temperature range. Do not inhale the vapours given off as they may be toxic. Liquids should be safely discarded and replaced.



Do not use the TX150/TXF200 with flammable heat transfer liquids.



Do not use the TX150/TXF200 to heat any sample material that could cause a fire or any other kind of hazard.



Do not use the equipment in an area where there are aggressive or explosive chemical mixtures.



If a potentially hazardous liquid is spilt onto or inside the equipment, disconnect it from the power supply and have it checked by a competent person.



It is the user's responsibility to carry out appropriate decontamination if hazardous material is spilt on the equipment.



If there is a warning message on the screen, do not touch the liquid or the bath surfaces, they may be very hot.



Refill carefully, a hot heater can cause a spattering of very hot water droplets and scalding steam.



Do not touch surfaces which become hot during high temperature operation.

4.0 Operating instructions

4.1 Unpacking instructions

Standard equipment includes:

- Immersion thermostat (TX150 or TXF200)
- Pump outlet plates
- Mains cord with plug
- Operating manual
- Quick start guide

ST bath accessory includes:

- Stainless steel bath
- Bridge plate
- Circulating tray (ST18, ST26 & ST38 baths only)

P bath accessory includes:

- Plastic bath
- Bridge plate

Remove packing materials carefully and retain them for future shipment or storage of the equipment.

4.2 Fitting controller to ST baths

The TX150/TXF200 can be fitted to the following stainless steel baths, ST5, ST12, ST18, ST26 and ST38 in two orientations for convenience, facing over ST bath (A) or facing outwards (B):

1. Fit the TX150/TXF200 through the hole in the bridge plate and align using the locating threads. Secure using the retaining nuts (1). Hand tighten only.
2. Hook the assembly into the slots on the ST bath and use the supplied fixing to secure to the rear of the bath (2).

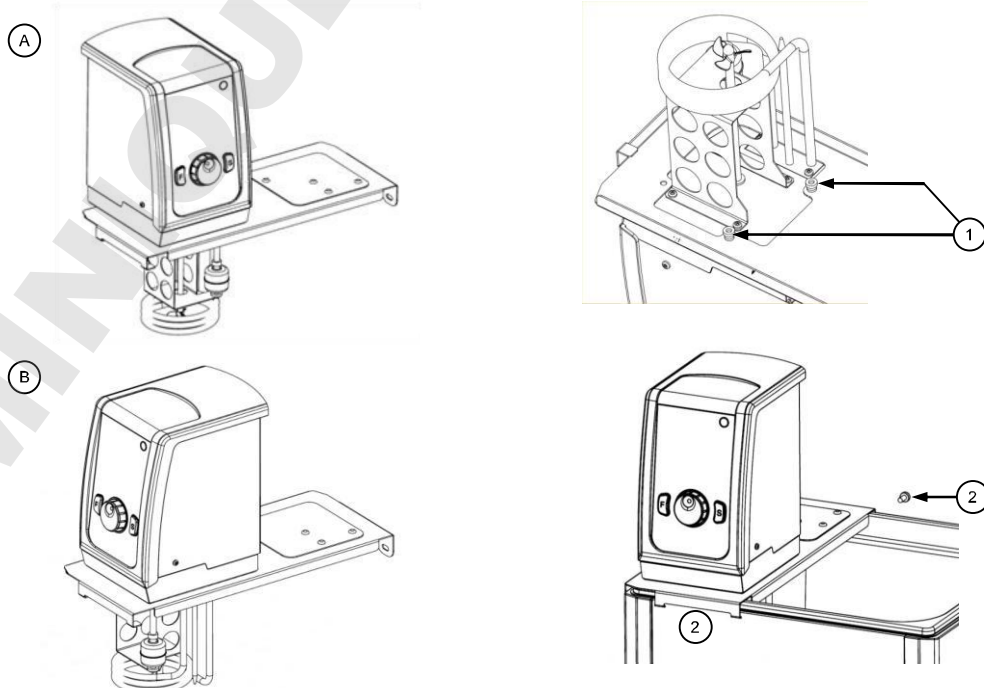

EN

Fit the circulation tray in the base of the tank with the large cut out in the tray underneath the control unit (ST18, ST26 & ST38 only).

4.3 Fitting the controller to P baths

The TX150/TXF200 can be fitted to the following plastic baths, P5, P12 and P18:

1. Fit the TX150/TXF200 through the hole in the bridge plate and align using the locating threads. Secure using the retaining nuts (1). Hand tighten only.
2. Add the assembly to the P bath and use the supplied fixing to secure to the rear of the bath (2).

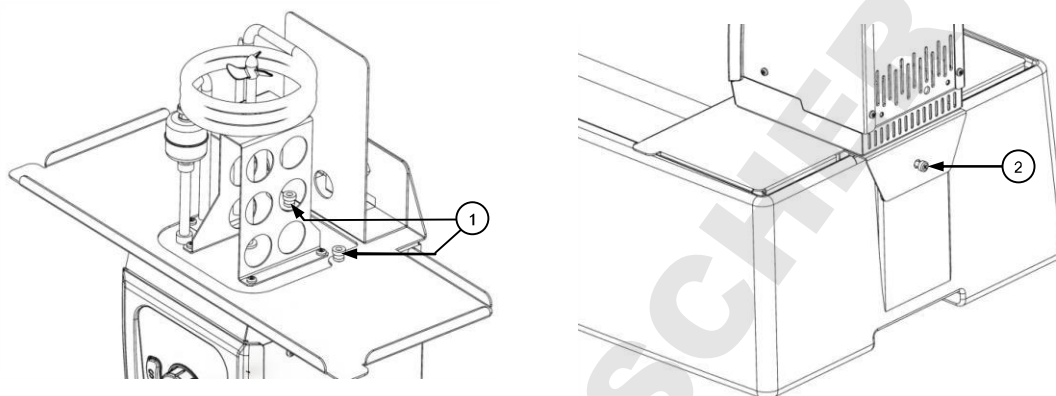

4.4 Fitting the controller to custom baths

A clamp can be fitted to the TX150/TXF200 to allow attachment to a non-Grant bath or vessel with a wall thickness of up to 30mm. To fit the clamp to the TX150/TXF200:

1. Place clamp over locating threads on base of TX150/TXF200. Secure using the retaining nuts. Hand tighten only.
2. Add clamp rear fixings to secure to rear of TX150/TXF200.

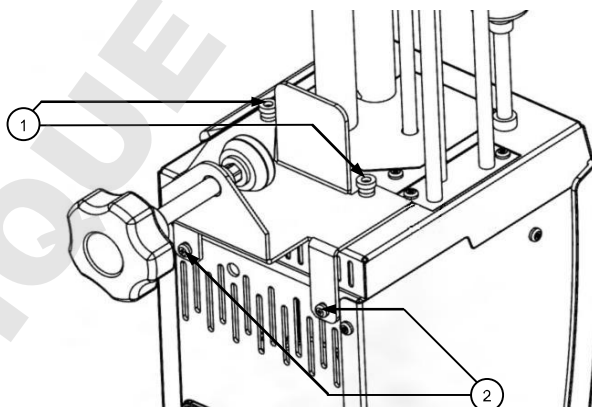

Take care not to over tighten the clamp to avoid damaging the clamp or vessel



The liquid container on which the unit is mounted must be stable and have the necessary robustness, mechanical, chemical and heat resistance.

Do not wash the clamp in a dishwasher or clean it with descaler. Do not submerge the threaded shaft of the clamp. Always dry the threaded shaft and clamp after cleaning. The threads may be lubricated with a small amount of light machine oil.

4.5 Removing the controller from the bridge plate

Allow the working liquid to cool before removing the TX150/TXF200 from the bridge plate. Carefully remove the TX150/TXF200 and bridge plate together from the bath or vessel. Take care as the pump will contain a small amount of the working liquid which will leak out as the unit is handled. Undo the retaining nuts and remove the bridge plate. Attach the retaining nuts to the locating threads for safe keeping.

4.6 Recommended liquids

The following table lists the recommended liquids for different temperature ranges. Always ensure the liquid used is safe and suitable for your working temperature. If using non-recommended heat transfer liquids, it is the responsibility of the user to conduct an assessment to ensure the intended fluid is compatible with the TX150/TXF200 and vessel.



To ensure protection the overtemperature cut-out must be set appropriately for the heat transfer liquid selected see table.



If using non-recommended heat transfer liquids it is important to set the over-temperature cut-out to a value no higher than 25°C below the fire point of the liquid. If in doubt please contact the Grant technical support team.



Use fume extraction when using silicone fluids at elevated temperatures

Temp range	Recommended liquid	Cut-out setting	Comments
-50°C to 50°C	Silicone Oil, low viscosity	60°C	Bayer Silicone M3 is a suitable liquid
-30°C to 70°C	50% water, 50% antifreeze (inhibited ethylene glycol)	80°C	WARNING: Ethylene glycol is toxic – follow the manufacturer's instructions. For safe disposal consult your local regulations. Use a lid to reduce the dilution of the mixture caused by condensing water vapour from the air, and to maintain the cool down rate.
0°C to 30°C	80% water, 20% antifreeze (inhibited ethylene glycol)	40°C	
5°C to 99.9°C	Water*	110°C	Water can be used but care should be taken above 60°C as hot vapour can be dangerous. Use a lid or polypropylene spheres above 60°C to ensure good performance & reduce evaporation. At temperatures approaching 99°C the temperature performance will be affected due to localised boiling. *The units should not be used to boil water.
70°C to 150°C	Silicone fluid Viscosity ~20cS Flash point ≥230°C Fire Point ≥280°C	160°C	Dow Corning DC200/20 silicone fluid is a suitable liquid – follow the manufacturer's instructions. For safe disposal consult your local regulations.
70°C to 200°C	Silicone fluid Viscosity 50cS centistokes Flash point ≥285°C Fire Point ≥340°C	210°C	Baysilone M 50 EL silicone fluid is a suitable liquid - follow the manufacturer's instructions. For safe disposal consult your local regulations.

Temp range	Recommended liquid	Cut-out setting	Comments
-50°C to 150°C or 200°C	None	As required for safety	Override range - The user must select a suitable safe liquid and carry out their own risk assessment before use. Note that the control when using this setting may be affected as the liquid characteristics are unknown.

4.7 Installation



Place the water bath on a level, non-combustible surface. Ensure that the mains plug and the switch at the rear of the unit are easily accessible.



If the equipment has been transported or stored in cold or humid conditions, condensation may form inside it. If that could have happened, allow time (at least 2 hours at room temperature) for the condensation to evaporate before using the equipment.



Do not block or restrict ventilation slots.

4.8 Electrical supply



Check that the supply voltage marked on the serial number label, and the type of mains plug, are correct for your mains supply outlet, which must have an earth (ground) connector.



The TX150/TXF200 must only be connected to the mains using the mains cord supplied or one with an identical rating (see section 9.4)

4.9 Using accessory cooling (C1G, C2G, CW5)

Accessory cooling is required for operation at temperatures below ambient. Refrigerated dip coolers (C1G and C2G) can be used for operation down to -15°C. A water heat exchanger coil (CW5) can be used for operation at or around ambient. The coils can be fitted:

1. Attach u-shaped coil locating rod to cover plate using two fixings supplied (1).
2. Fit the cooling coil through the hole in the bridge plate and align outlet pipes with cut-out notch (2).
3. Fit cover plate (3) onto bridge plate and attach with fixings supplied. The coil locating rod should press fit against the inside of the coil and hold it rigidly. Ensure the coil is held safely and securely before operation.

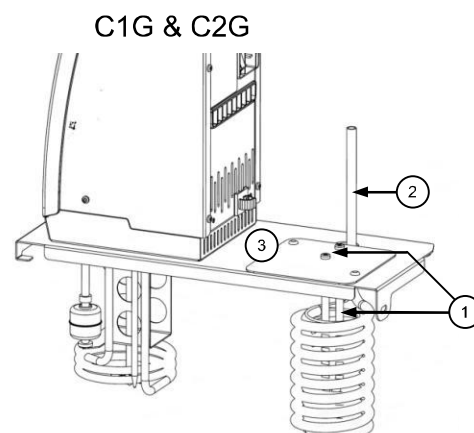
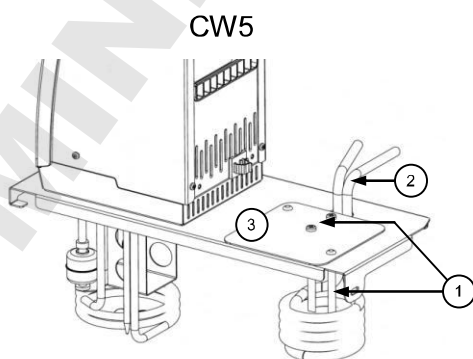

5.0 Operating procedures

5.1 Operation

5.1.1 Liquid level

The minimum and maximum liquid levels are defined in section 6.4 for Grant accessory baths. Liquid level should always be maintained between these levels. These levels apply both when there are no vessels in the bath and with the maximum contents. If using liquids that can evaporate then periodic checking and refilling should be completed. The low level float switch will alarm if the liquid level drops below the minimum required level and the unit will switch off the heater and stop temperature control.

5.1.2 Operation above 60°C

A lid or polypropylene spheres must be used above 60°C to maintain temperature control and to ensure that the bath fluid temperature reaches the set point. They will save energy by preventing excessive evaporation and reduce the frequency that the bath needs to be refilled. As a precaution, the TX150/TXF200 may display 'Overheating-power reduced' if heating water at or near boiling over extended periods or heating large volumes of liquid with large thermal losses without the use of a lid or polypropylene spheres. In this event the heating power is reduced by 50%. See section 11 for additional guidance.

Care should be taken to ensure rear inlet vents are clear and minimise the intake of steam or fumes when operating at or near water boiling or with other evaporating liquid.



Take care when lifting and removing the lid as it may be hot. Steam and hot vapours can cause scalding.



5.1.3 Operation at low temperatures

Accessory cooling is required for controlled operation at or below ambient temperature. The minimum working temperature without accessory cooling depends on the size of the bath. The small baths, P5 and ST5, have a minimum working temperature of approximately 10°C above ambient without a lid and 15°C above ambient with a lid. Other bath sizes can be used at a temperature of 5°C above ambient.

5.1.4 Using the pump

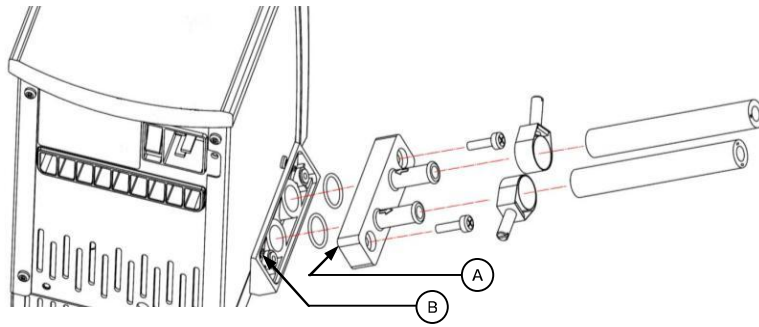
The TX150/TXF200 allows liquid to be pumped around a closed external system (not open to the atmosphere). It may be used for circulation through an external open tank only if a gravity feed return is present. An assessment of any open system should be completed to ensure liquid levels are stable during operation and there is no chance of any reservoir running dry or overflowing. The pump is fitted with a blanking plate as standard. Fit a pump connector plate as shown below. Note: the blanking/connector plates have a locating hole (see A below) to assist correct alignment onto the pump moulding. It is important to verify the hole is aligned with the corresponding locating pin (see B below) on the pump moulding. Failure to do so will result in a leaking connection. Retain the blanking plate for refitting when the pump is no longer required.



-  Always use pump connectors and hoses that are suitable for the operating temperature and liquid used. Check the pipe connections are secure.
-  Never disconnect any pipes or hoses while they contain very hot or very cold liquids or while the TX150/TXF200 is pumping.

Pumping heat transfer liquid around an external system can lead to hazards that are outside the control of Grant Instruments. It is essential that the user conducts a risk assessment of the entire equipment installation to ensure that correctly rated materials have been used throughout and that the system can be used safely.

5.1.5 Using the switch over relay output

An internal relay provides switch over contacts that can be used to control external equipment. The pin connections on the rear panel 3 pin circular connector are:

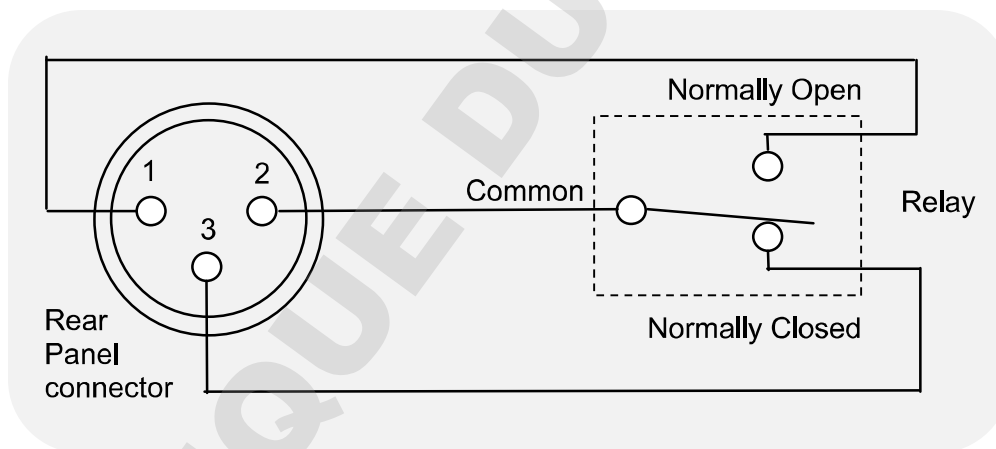

For the connecting cable use a mating XLR style connector such as the NC3FXX manufactured by Neutrik AG

The switch over contacts are rated at 24V AC or DC 2A maximum.

-  The relay is rated 24Vac or dc at 2A; to prevent injury or equipment damage, do not connect to greater voltages or attempt to switch greater currents.

-  Voltages as low as 22Vac can be hazardous in locations where wetting of the skin can occur. When making up cable to connect your equipment to the relay connector, on the TX150/TXF200, make sure that the insulation system used is adequate to provide protection against the voltages output by your equipment for switching by the relay.

-  Always use the correct size cable with correct class of insulation for the voltage being switched. If in doubt contact the technical support team at Grant.

5.1.6 Emptying the ST baths

The ST12, ST18, ST26 & ST38 baths should be emptied to a safe level prior to moving. A drain tap is included on these baths to allow convenient emptying.



Allow the liquid temperature to fall to a safe level before emptying or moving.

CAUTION: if the bath is drained at temperatures above 50°C then the drain mechanism will be damaged and will need to be replaced. Take reasonable precautions to prevent accidental spillage.

Empty the bath by pushing the supplied drain insert into the drain tap as shown below. Note that the bath liquid will begin to empty as soon as the drain insert is fully engaged. A length of hose can be added to the barbed end of the drain insert if required.

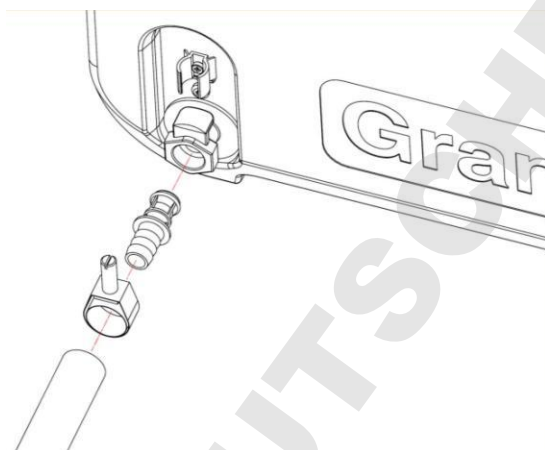

5.1.7 Setting up and switching on

Attach the TX150/TXF200 securely to the required bath or vessel. Add the appropriate working liquid to the bath to at least the minimum recommended fill level such that the float level switch is fully raised.

Connect the TX150/TXF200 to a grounded (earthed) electrical power supply with voltage and frequency within the range specified on the serial number plate.

Switch on the TX150/TXF200 using the power switch on the rear of the unit. The motor will start immediately and the buzzer will sound while the unit starts up. During start up the display will show the software version before displaying the home screen. The TX150/TXF200 is ready to use.

To disconnect the equipment from the mains supply, remove the mains plug from the mains supply outlet.

5.1.8 Power loss

If power is lost, either due to the unit being switched off or due to a power failure, then when the power is restored the unit will return to the home screen (see 5.2.7) with the last valid set temperature and pump speed. Note that, if a program was running (see 5.2.13), the set temperature will be the one set before the program started. If a preset was in use (see 5.2.11) then the set temperature and pump speed will be correct but the preset number will not be displayed. The countdown timer (see 5.2.12) will be stopped.

5.2 Using the TX150 & TFX200

5.2.1 Front panel controls



5.2.2 Rear panel connections

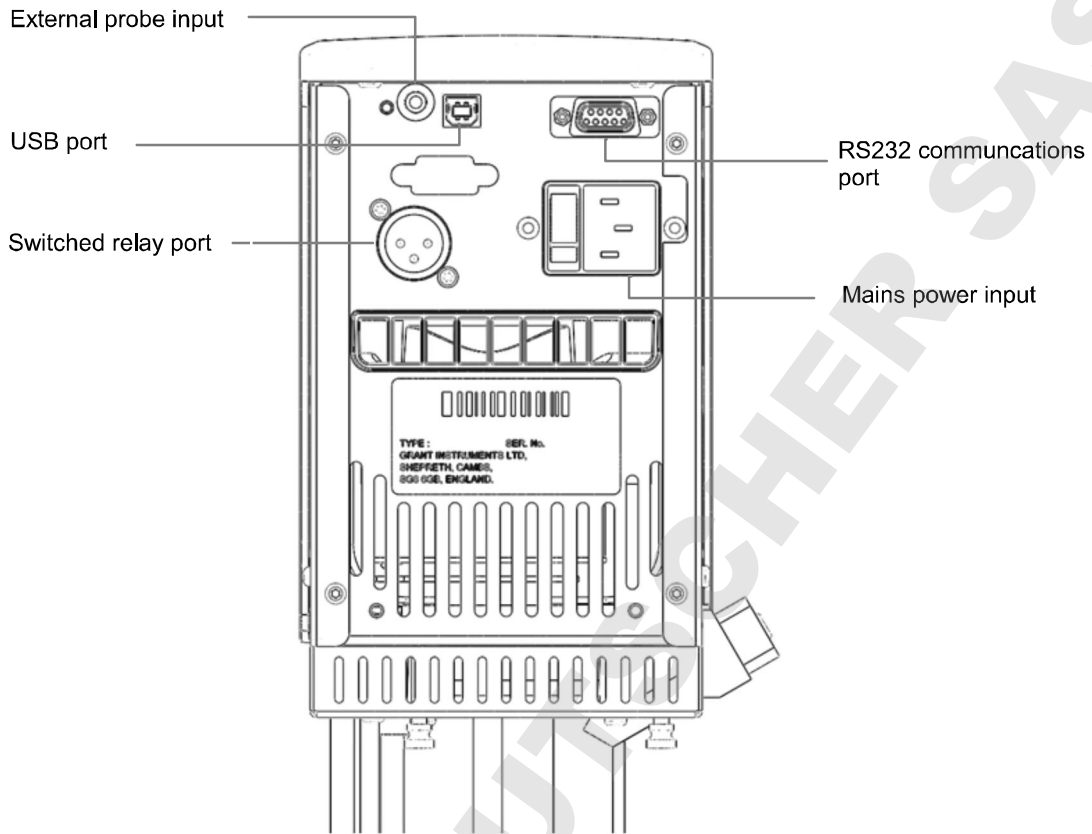

5.2.3 Communications ports

The TX150 and TXF200 provide a RS232 and a USB data port for communication with a PC running Grant Labwise™ software. Labwise™ provides the ability to remotely configure, control, monitor programs as well as log program temperature data. Only use a RS232 cable supplied by Grant instruments. The USB cable is a Type A to Type B style

5.2.4 Switched relay port

An internal relay provides switch over contacts that can be used to control external equipment. See Section 5.1.5 for details of the relay contacts and connector type.

5.2.5 External probe input

For connecting an external PT1000 temperature probe available from Grant instruments

5.2.6 Setting the over-temperature thermostat

An over-temperature cut-out dial with a temperature scale is located at the top right of the unit. The over-temperature probe independently monitors the bath temperature and switches the heater off if it goes above the cut-out threshold.

Coarse setting of the over-temperature thermostat

Rotate the temperature cut-out dial in line with the marked scale to the desired setting. This should be higher than the set temperature to avoid operating the cut-out before the set temperature has been reached.

If the alarm is triggered the sounder can be silenced by pressing either the **F** or **S** button once. To continue to use the TX150/TXF200, let the bath liquid cool by at least 5°C, either naturally or by replacing the liquid, switch the unit off, wait 10 seconds and switch it on again to clear the alarm. To avoid nuisance tripping the trip point needs to be set at least 5°C above the desired control temperature.

Alternative setting of the over-temperature thermostat

Rotate the temperature cut-out dial to maximum (or at least a value above the level required) and configure the set temperature to the cut-out level required. Leave the bath to reach the set temperature and stabilise for at least 5 minutes. Turn the cut-out dial slowly anticlockwise until an over-temperature fault is displayed on screen and the alarm sounds continuously. This gives an over-temperature trip point at the set temperature. The audible alarm can be cancelled by pressing either the **F** or **S** button once.

To continue to use the TX150/TXF200, let the bath liquid cool by at least 5°C, either naturally or by replacing the liquid, switch the unit off, wait 10 seconds and switch it on again to clear the alarm. To avoid nuisance tripping the trip point needs to be set at least 5°C above the desired control temperature.

5.2.7 Display. Explanation of home screen icons.

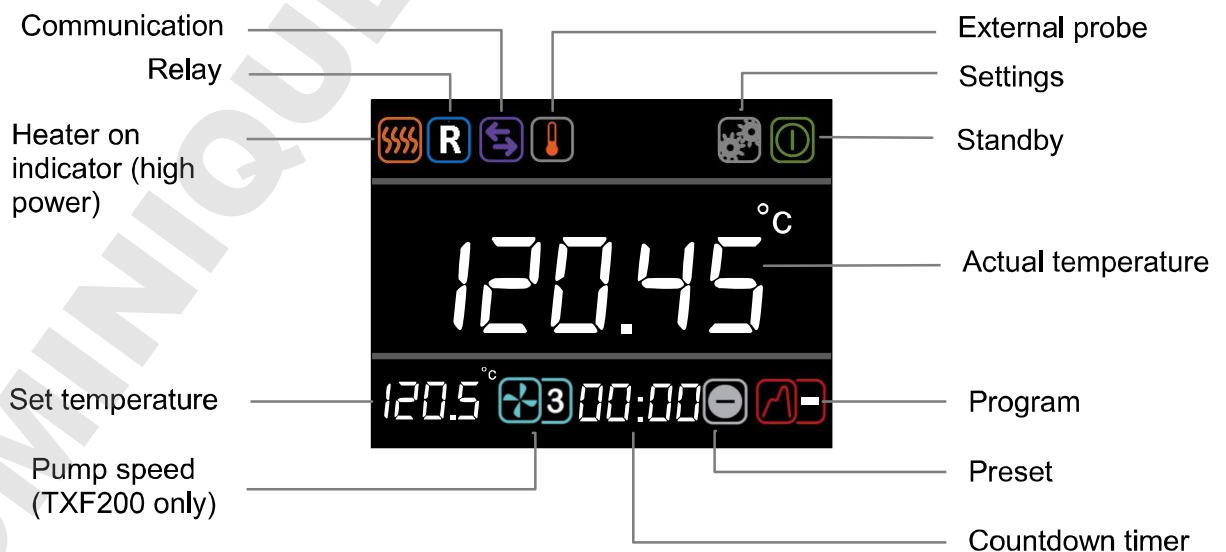

5.2.8 Description of user interface and controls

The TX150/TF200 features a full colour graphic display, a main dial and two buttons **F** and **S**. All functions (setting temperature, pump speed, countdown timer, presets, programs settings and standby mode) can be configured from the home screen. Navigation around the home screen is achieved by rotating the main dial which moves a white cursor to highlight function icons. Pressing the **S** button whilst the icon is highlighted will change the colour of the cursor to red, make the icon active and allow changes to be made, or in the case of the settings icon, further menus to be displayed.

The primary function of the **F** button is to exit functions and menus. If **F** is pressed when in the home screen whilst the cursor is white then the settings menu is displayed.

5.2.9 Setting the control temperature



1. Rotate the dial until the **set temperature** icon is highlighted, press the **S** button.

2. Rotate the dial to set the desired temperature.

*If no key is pressed for 10 seconds or if **F** is pressed, the set temperature icon is no longer active and will remain at its original value.*

3. Press **S** to store the requested value.

If the temperature selected is higher than the current liquid temperature the heater will switch on and the heater icon will be displayed. The temperature setting range will be limited to the operating range of the selected liquid.

Refer to section 4.6 to find the allowable temperatures for each liquid.

5.2.10 Setting a pump speed (TXF200 only)



1. Rotate the dial until the **pump speed** icon is highlighted, press the **S** button.

2. Rotate the dial to set the desired pump speed over a range of 1 to 5 (1= lowest speed, 5 = highest speed).

*If no key is pressed for 10 seconds or if **F** is pressed, the pump speed icon is no longer active and will remain at its original value.*

3. Press **S** to store the pump speed.

The pump will now operate at the stored pump speed. For set temperatures above 150°C, the pump will automatically operate at a minimum of speed 3.

5.2.11 Running a bath preset

Each TX150/TXF200 contains three presets which can be configured to different set temperatures and in the case of the TXF200 the pump speed can additionally be configured. This allows the bath to be conveniently run at frequently used temperatures and pump speeds. See section 5.3.1 for information on preset configuration.



1. Rotate the dial until the **preset** icon is highlighted, press the **S** button.
2. Rotate the dial to select the desired preset 1, 2 or 3, press **S** to run the preset.

The preset will automatically start as soon as S is pressed.

If no key is pressed for 10 seconds or if F is pressed the preset icon is no longer active and will remain at its original value.

If the set temperature of the preset is not allowed for the selected liquid (e.g. a preset of 150°C when using water) then the preset icon will return to “-“ and the preset will not be used.

Refer to section 4.6 to find the allowable temperatures for each liquid.

5.2.12 Running a countdown timer

The countdown timer on the TX150/TXF200 can be set in the range of 1 minute to 99 hours. The countdown timer will sound a buzzer at the end of a countdown period. See section 5.3.2 for information on configuring countdown timer expiry actions.



1. Rotate the dial until the **countdown timer** icon is highlighted, press the **S** button.

The countdown timer will display the last countdown time set.

If no key is pressed for 10 seconds or if F is pressed the countdown timer setting is no longer active and will remain at its original value.

2. Rotate the dial to set the desired countdown time, press **S** to store.

The countdown timer will begin counting down from the set time. At the end of the countdown timer period a buzzer will sound. This can be cancelled by pressing F or S.

To cancel an active countdown timer:

1. Rotate the dial until the **countdown timer** icon is highlighted, press the **S** button.
2. Press the **F** button to cancel the countdown timer.
The countdown timer is stopped.

5.2.13 Running a program

The TX150/TXF200 has the capability to run automatic temperature profiles called programs. The TX150 has the capacity to store 1 program containing 30 individual temperature/time segments. The TX150 can only be configured and edited using Grant Labwise™ software. The TXF200 has the capacity to store 10 programs, each containing 100 individual time/temperature segments. The TXF200 programs can be configured directly on the unit or through Grant Labwise™ software. See section 5.3.2 for information on program configuration via the unit (TXF200 only). When a program is running icon access is limited to the standby and program functions



1. Rotate the dial until the **program** icon is highlighted, press the **S** button.

*If no key is pressed for 10 seconds or if **F** is pressed, the program icon is no longer active and will remain at its original value.*

2. Rotate the dial until the desired program is displayed (TXF200 = 1 to 10). By default the TX150/TXF200 will display program “–” indicating that no program is selected. Press **S** to select the program.

The selected program will start. The display will show the target temperature of the first segment and the countdown timer will indicate the duration of the program remaining. The TXF200 will display the pump speed set for the first segment. Whilst a program is running only the Standby icon can be selected.

*At the end of a program the buzzer will sound, this can be cancelled by pressing **F** or **S**.*

If the program is not valid, e.g. it has no segments set up, or any segment of the program contains a target temperature which is not valid for the selected liquid, e.g. trying to ramp to 150°C using water, then the program will not run and the program icon will revert to “–”. Edit the program or select a suitable liquid.

Refer to section 4.6 to find the allowable temperatures for each liquid.

To stop a program

1. Rotate the dial until the **program** icon is highlighted, press the **S** button.

*If no key is pressed for 10 seconds or if **F** is pressed, the program icon is no longer active and will remain at its original value and the program will continue to run.*

2. Rotate the dial until the “–” is displayed, press **S** to select

The program will stop. The display will remain at the set temperature reached when the program was stopped, the countdown timer will stop at the remaining time and the pump speed will display the last speed set.

5.2.14 Activating standby mode

In standby mode the TX150/TXF200 is still powered, however key functions (heating, pump, countdown timer and programs) are switched off. In standby mode access is limited to the settings menu, enabling the functions such as alarms and programs to be configured while the unit is not operating.

Note. When entering standby mode the pump will remain on for 5 minutes to allow internal cooling to continue.

If a countdown timer has been set or a program is running before activating standby mode they will be terminated.



1. Rotate the dial until the **standby** icon is highlighted, press the **S** button.

*The **temperature** and **countdown timer** values are no longer displayed.*



2. To resume operation, rotate the dial until the **standby** icon is highlighted, press the **S** button.

The display returns to the home screen and the TX150/TXF200 resumes operation at the last temperature and pump speed set.

5.2.15 Accessing the settings menu

The settings menu provides access to the following settings screens: preset selection and definition, program selection and definition, liquid type, probe (internal or external), alarms, buzzer level, relay state, language and display rounding. Section 5.3 provides detailed information on viewing, editing and saving settings.



1. Rotate the dial until the **settings** icon is highlighted, press the **S** button.

The settings menu is displayed, with presets highlighted at the top of the list.

Shortcut to settings menu. Pressing F whilst in the home screen when the cursor is white will automatically display the settings menu

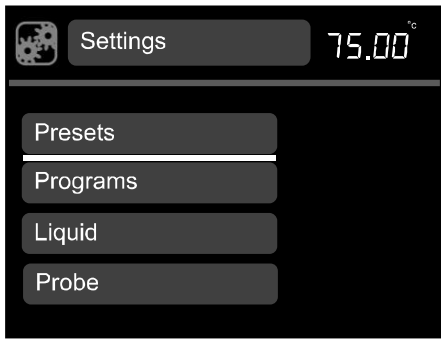

2. Rotate the dial to scroll up and down the list, until the desired setting is highlighted, press the **S** button to select. The desired settings menu is displayed.

*Pressing **F** returns to the home screen without making changes.*

5.3 Viewing, editing and saving settings

5.3.1 Configuring a preset



1. Rotate the dial until the **settings** icon is highlighted, press the **S** button.

Pressing F returns to the home screen without making changes.

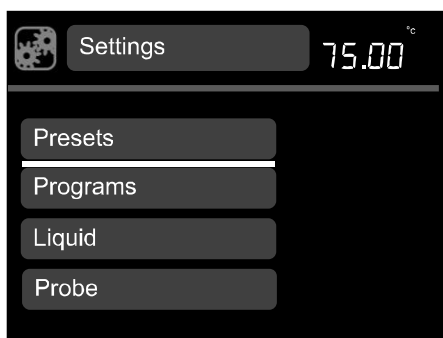

2. Rotate the dial to scroll up and down the list, until **presets** is highlighted, press the **S** to select.

Pressing F returns to the settings screen without making changes.

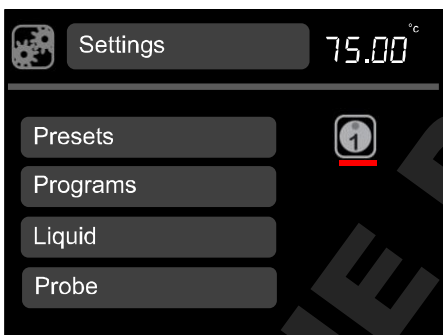

3. Rotate the dial to display preset icon 1, 2 or 3, press **S** to select.



4. **Temperature** is highlighted, press the **S** button. Rotate the dial to define the temperature. Press **S** to set.

Pressing F restores the original preset temperature with temperature highlighted.

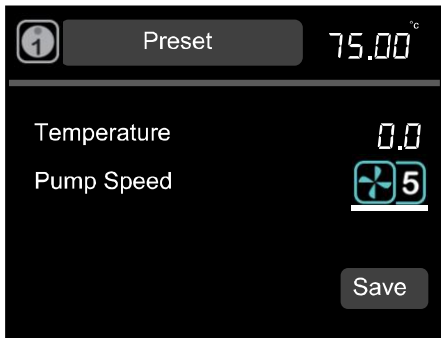

5. Rotate the dial to highlight **pump speed**, press **S** to select. Rotate the dial to display pump speed (1 to 5), TXF200 only. Press **S** to set.

*Pressing **F** restores the original preset pump speed with pump speed highlighted.*

To save the temperature and pump speed configuration, rotate the dial to highlight **save** and press **S**.

The display returns to the settings menu screen.

Repeat procedure to configure presets 2 and 3

6. Press **F** to return to the home screen.

5.3.2 Creating a program (TXF200 only)



1. Rotate the dial until the **settings** icon is highlighted, press the **S** button.

*Pressing **F** returns to the home screen without making changes.*

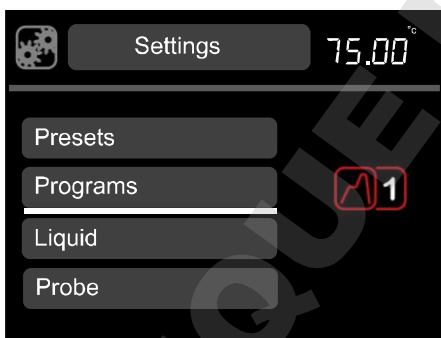

2. Rotate the dial to scroll up and down the list, until **programs** is highlighted, press **S** to select.

The program icon is displayed

3. Rotate the dial to select the program to be created. Press **S** to select.

Segment 1 screen is displayed.



4. **Target temperature** is highlighted, press **S** to select.

5. Rotate the dial to define the target temperature. Press **S** to set.

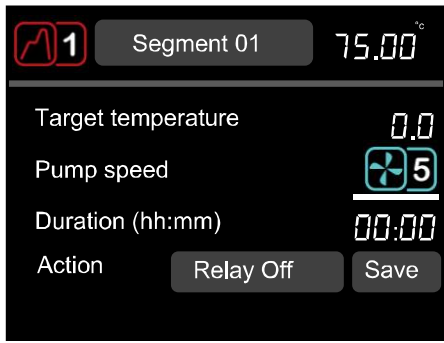

6. Rotate the dial to highlight **pump speed**, press **S** to select
7. Rotate the dial to the desired pump speed (1 to 5). Press **S** to set.

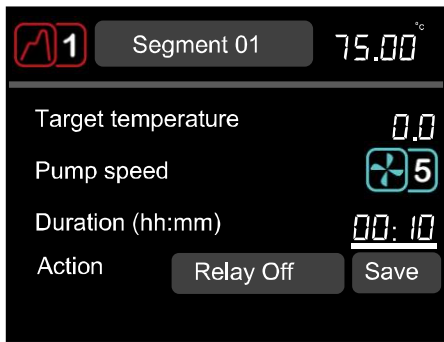

8. Rotate the dial to highlight **duration**, press **S** to select.
9. Rotate the dial to define the duration of the first segment (**hh:mm**). Minimum segment duration is 1 minute, maximum 99 hrs 59 mins. Press **S** to set.

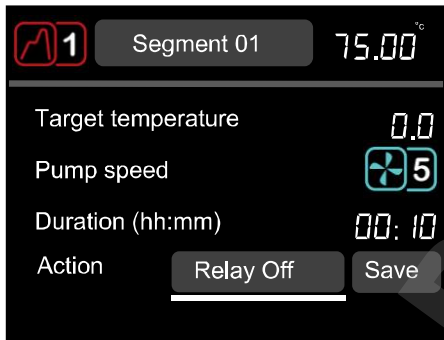

10. Rotate the dial to highlight **action**, press **S** to select.
11. Rotate the dial to toggle between **relay on/off**. Press **S** to select.
12. Highlight **save** to store segment 1.

The program screen is displayed.

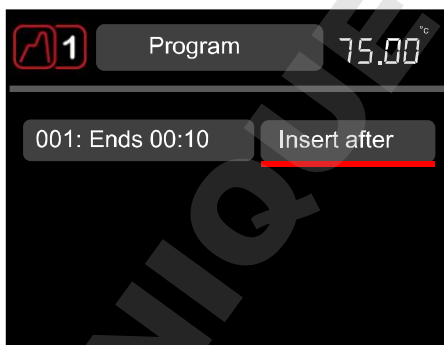

13. To insert a new segment, highlight segment 1, press **S**. Rotate the dial to display **insert after**, press **S** to select.

Segment 2 screen is displayed. Repeat steps 4 to 12 to create a new segment.

To dwell for a period at a particular temperature, set the temperature to the same value as the previous segment and then set the time to the required dwell period.

14. On completion of programming, press **F** twice to return to the home screen.

5.3.3 Editing a program (TXF200 only)



1. Rotate the dial until the **settings** icon is highlighted, press the **S** button.

*Pressing **F** returns to the home screen without making changes.*

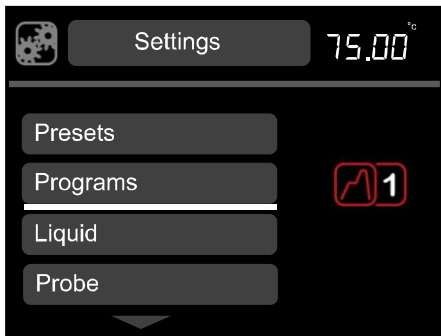

2. Rotate the dial to scroll up and down the list, until **programs** are highlighted, press **S** to select.

The program icon is displayed

3. Rotate the dial to select the program to be edited (1 to 10). Press **S** to select.

The program screen is displayed.

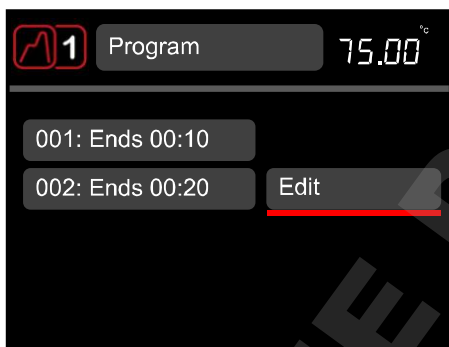

4. Highlight the segment to be edited, press **S**.

5. Rotate the dial to display **edit**, press **S** to select.

The segment screen is displayed and can be edited by following steps 4 to 12 in the previous section 'creating a program'.

6. Once editing is complete press **F** twice to return to the home screen.

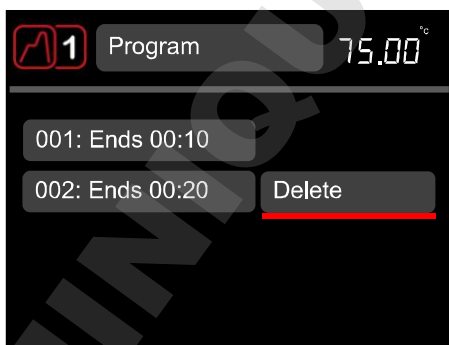

7. To delete a segment, highlight a segment, press **S**.

8. Rotate the dial to display **delete**, press **S** to select.

The segment will be deleted.

9. Press **F** twice to return to the home screen.

5.3.4 Selecting a liquid type

The liquid type determines the limits of the set temperature range.
Selection of the liquid types below changes the settable temperature range as follows:

Liquid	Set temperature range
Water	0°C to 100°C
Water-Glycol	*-30°C to 70°C
Low Temp Oil	-50°C to 50°C
High Temp Oil	†70°C to 150°C (TX150) ‡70°C to 200°C (TXF200)
Override	§-50°C to 150°C (TX150) §-50°C to 200°C (TXF200)

* Water-Glycol (50% water, 50% antifreeze (inhibited ethylene glycol))

† High Temp Oil (silicone fluid with the following characteristics: viscosity 20 centistokes, flash point ≥230°C, fire point ≥280°C).

‡ High Temp Oil (silicone fluid with the following characteristics: viscosity 50 centistokes, flash point ≥285°C, fire point ≥340°C).

§ When set to Override it is the user's responsibility to select a suitable safe liquid.

See section 4.6 for full description of recommended bath liquids.



1. Rotate the dial until the **settings** icon is highlighted, press the **S** button.

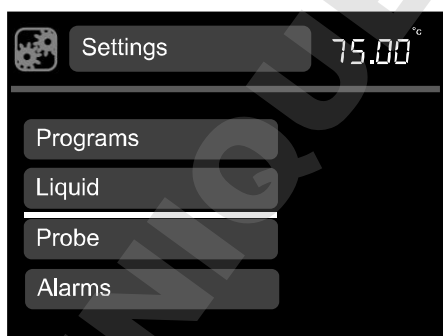

2. Rotate the dial to scroll up and down the list until **liquid** is highlighted, press **S** to select.

Liquid options are displayed.

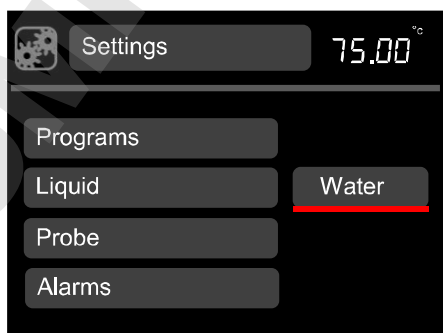

3. Rotate the dial to scroll through the liquid options, press **S** to save the selection.

The display returns to the settings screen.

4. Press **F** to return to the home screen.

5.3.5 Selecting a temperature probe type

The bath temperature can be controlled using an internal or external temperature probe.



1. Rotate the dial until the **settings** icon is highlighted, press the **S** button.

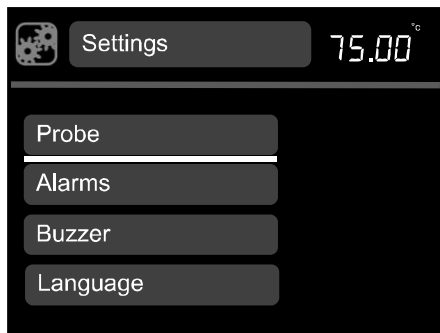

2. Rotate the dial to scroll up and down the list until **probe** is highlighted, press **S** to select.

Probe options are displayed

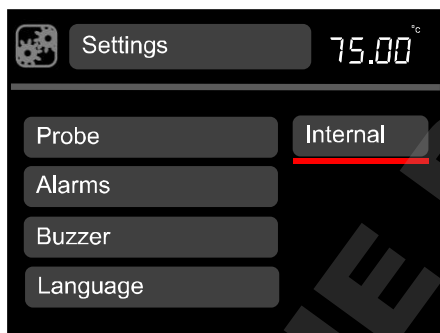

3. Rotate the dial to scroll through the probe types (**external** or **internal**), press **S** to save the selection

The display returns to the settings screen.

The external probe icon will be displayed on the home screen

4. Press **F** to return to the home screen.

5.3.6 Configuring high and low temperature alarms

There are three functions in the alarm menu.

1. A high alarm function, which causes an alarm condition when the bath temperature goes higher than the alarm value. The alarm value can be set as a fixed temperature above the set temperature or a deviation offset value above the set temperature. Below is an example of a high temperature deviation alarm, where the deviation value has been set to 5°C.

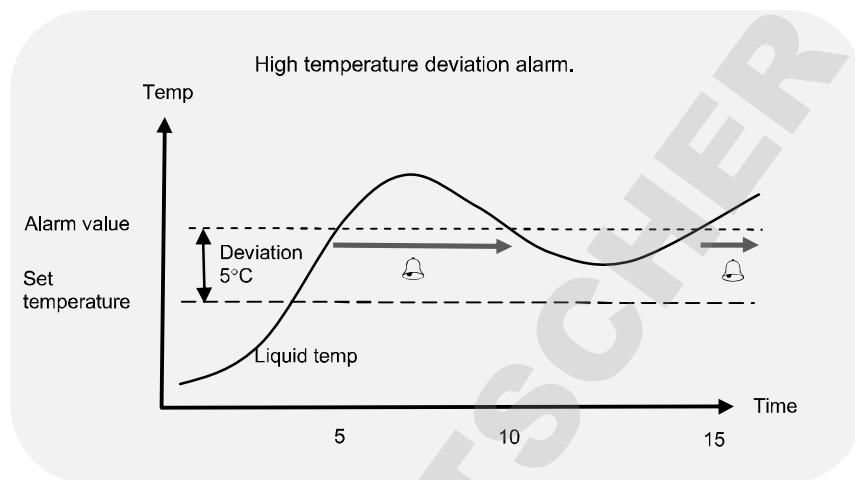

2. A low alarm function, when the bath temperature goes lower than the alarm value. The alarm value can be set as a fixed temperature below the set temperature or a deviation offset value below the set temperature. Below is an example of a low temperature fixed alarm, where the fixed temperature value has been set to -20°C.

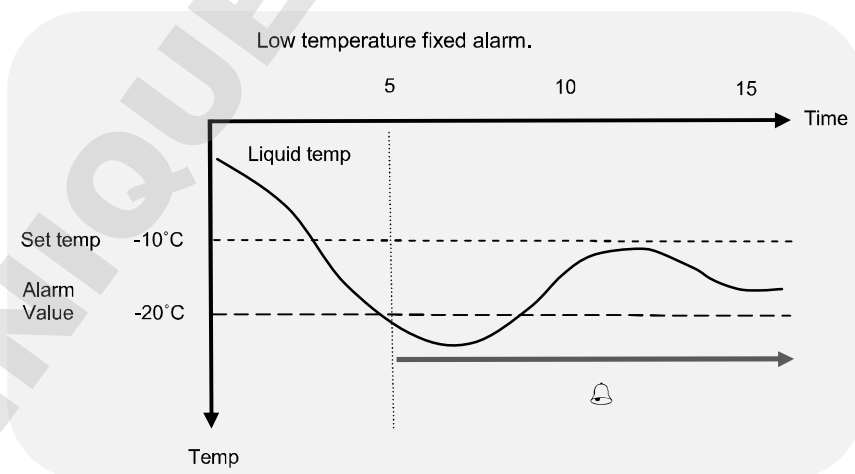

3. A hold-off time can be entered, which is a user adjustable time of between 0 and 21mins for which the alarms remain muted after either button has been pressed to acknowledge an alarm condition. If the bath returns to the value such that the alarm level is not exceeded the alarm will cancel. However, if the temperature remains outside the alarm level the alarm condition will re-occur after this hold-off time.

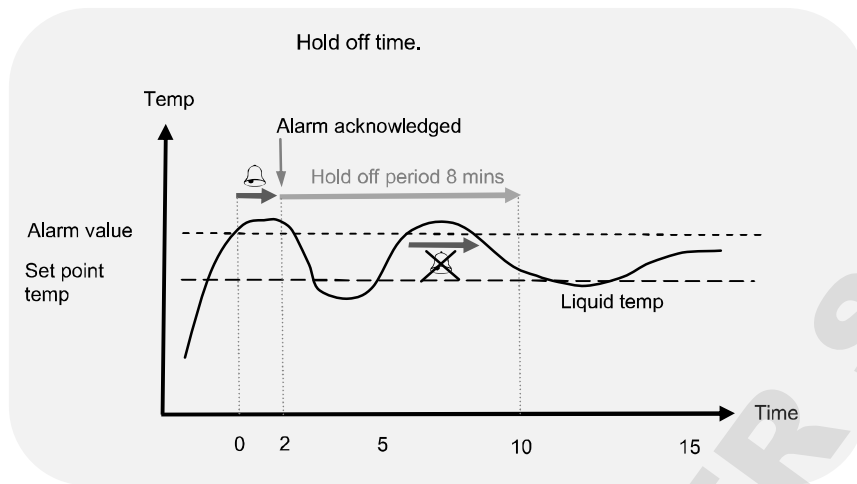

Each alarm can be programmed to latch, activate an audible buzzer and a relay. Alarms are cancelled by pressing the **F** or **S** button or if an alarm condition has been removed.



1. Rotate the dial until the **settings** icon is highlighted, press the **S** button.

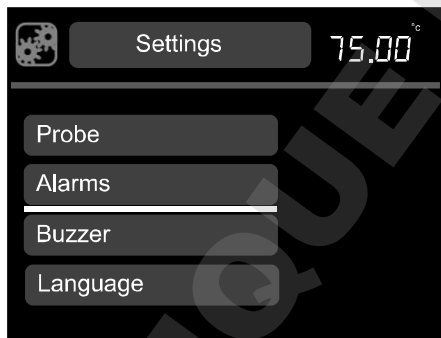

2. Rotate the dial to scroll up and down the list until **alarms** are highlighted, press **S** to select.

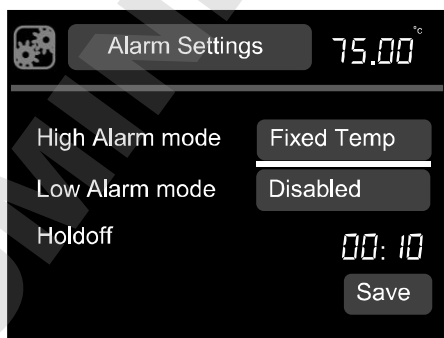

3. **High alarm mode** is highlighted, press **S** to select.
4. Rotate the dial to select **fixed temp**, **deviation** or **disabled**. Press **S** to select.

The high alarm screen is displayed

EN

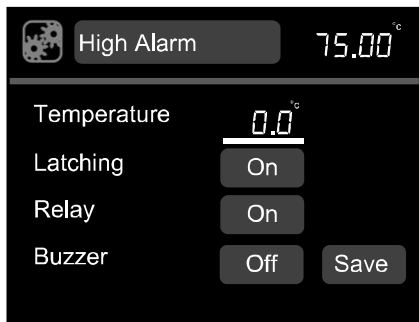

5. **Temperature** is highlighted, press **S** to select.
6. Rotate the dial to define the temperature value, press **S** to set.
7. Rotate the dial to highlight **latching**, press **S** to select.
8. Rotating the dial will display **on/off**, press **S** to select.

When latching is on, a temperature alarm continues unless acknowledged by the user even if the temperature comes back in range

9. Rotate the dial to highlight **relay**, press **S** to select.
10. Rotating the dial will display **on/off**, press **S** to select.
11. Rotate the dial to select **buzzer**, press **S** to select.
12. Rotating the dial will display **on/off**, press **S** to select.
13. Rotate the dial to **save**, press **S**. The display returns to the alarm settings screen. The procedure can be repeated to configure a deviation alarm and for the low alarm function.

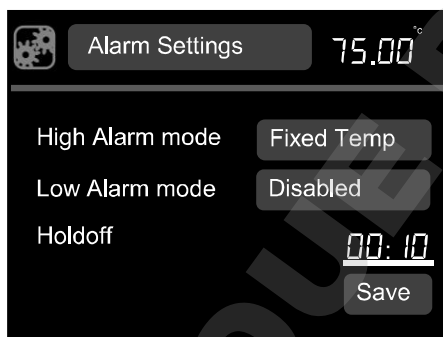

14. Rotate the dial to highlight **holdoff**, press **S** to select.
15. Rotate the dial to select a holdoff time (over a range of 10 seconds to 21 minutes), press **S** to select.

Rotate the dial to **save**, press **S** to save all settings.

The display will return to the settings menu

16. Press **F** to return to the home screen

5.3.7 Setting the buzzer volume level

Three buzzer volume levels are available, low, medium and high and off.



1. Rotate the dial until the **settings** icon is highlighted, press the **S** button.

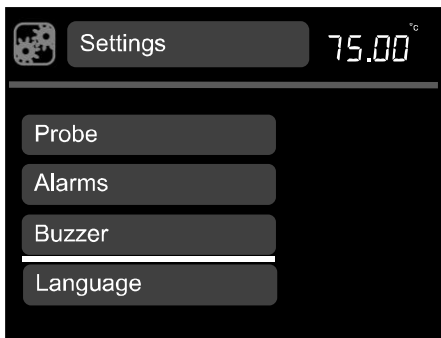

2. Rotate the dial to scroll up and down the list until **buzzer** is highlighted, press **S** to select.

Volume options are displayed.

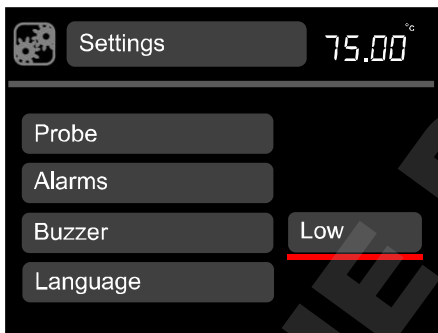

3. Rotate the dial to scroll through the volume levels (low, medium and high and off), press **S** to save the selection.

The display returns to the settings screen.

4. Press **F** to return to the home screen.

5.3.8 Selecting a language

Five language options are available, English, French, German, Italian and Spanish.



1. Rotate the dial until the **settings** icon is highlighted, press the **S** button.

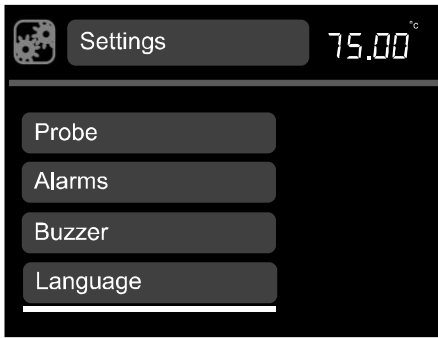

2. Rotate the dial to scroll up and down the list until **language** is highlighted, press **S** to select.

Language options are displayed.

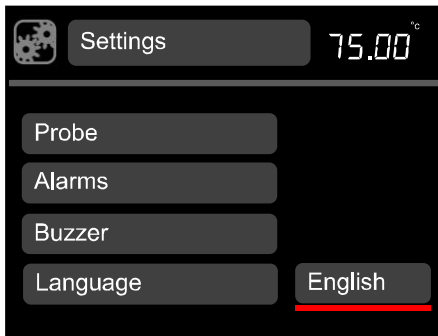

3. Rotate the dial to scroll through the language options (**English, French, German, Italian and Spanish**) press **S** to save the selection.

The display returns to the settings screen.

4. Press **F** to return to the home screen.

5.3.9 Relay test and configuration

The TX150 and TXF200 can be configured to switch a relay in the program function. This function can be tested manually outside the program function by following the instructions below.



1. Rotate the dial until the **settings** icon is highlighted, press the **S** button.

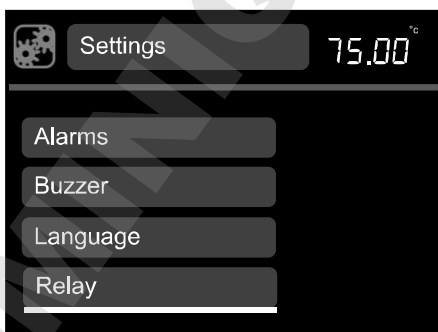

2. Rotate the dial to scroll up and down the list until **relay** is highlighted, press **S** to select.

Relay options are displayed

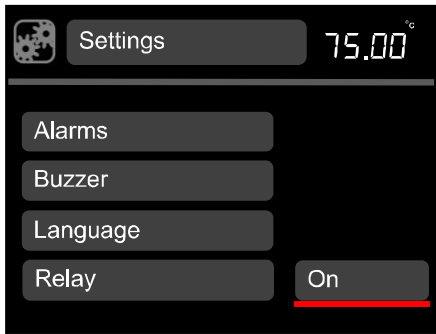

3. Rotate the dial to toggle between on/off, press **S** to save the selection.

The display returns to the settings screen.

4. Press **F** to return to the home screen.

5.3.10 Display rounding

The TX150 and TXF200 can be configured to show a rounded temperature display rather than showing the minor changes that occur as the heater pulses to maintain the temperature.



1. Rotate the dial until the **settings** icon is highlighted, press the **S** button.

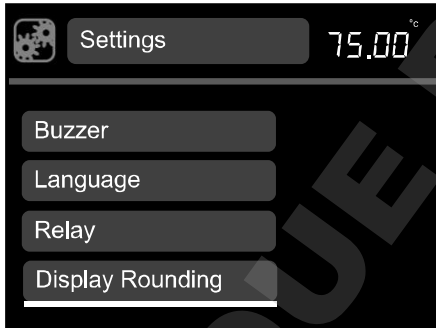

2. Rotate the dial to scroll up and down the list until **display rounding** is highlighted, press **S** to select.

Display rounding options are displayed.

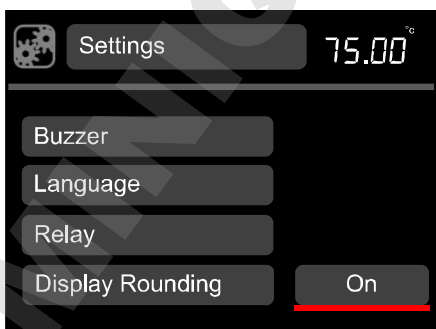

3. Rotate the dial to toggle between on and off, press **S** to save the selection.

The display returns to the settings screen.

4. Press **F** to return to the home screen.

5.4 Completing a calibration

The TX150 & TXF200 allow up to five temperature points to be calibrated. The calibration menu can be accessed by simultaneously pressing the **F** and **S** buttons for 3 seconds

The calibration temperatures are constrained by the temperature limits of the liquid type setting. Calibration should be carried out using a traceable reference thermometer with an accuracy of at least 0.1°C. This thermometer should be held securely in the centre of the bath or vessel.

Two factory defined calibration points (20°C and 70°C) already exist and are displayed in the calibrate probe menu, these may be recalibrated if required and up to a further three calibration points added. Calibration points should be chosen to be at critical experimental temperatures where accuracy is important or at the extremes of the working range of used temperatures.

The TX150/TXF200 calculates the temperature at any point using calculated values that pass through each calibration point. This ensures precision at all critical experimental temperatures throughout the range in use. In the example below, 4 calibration points have been used.

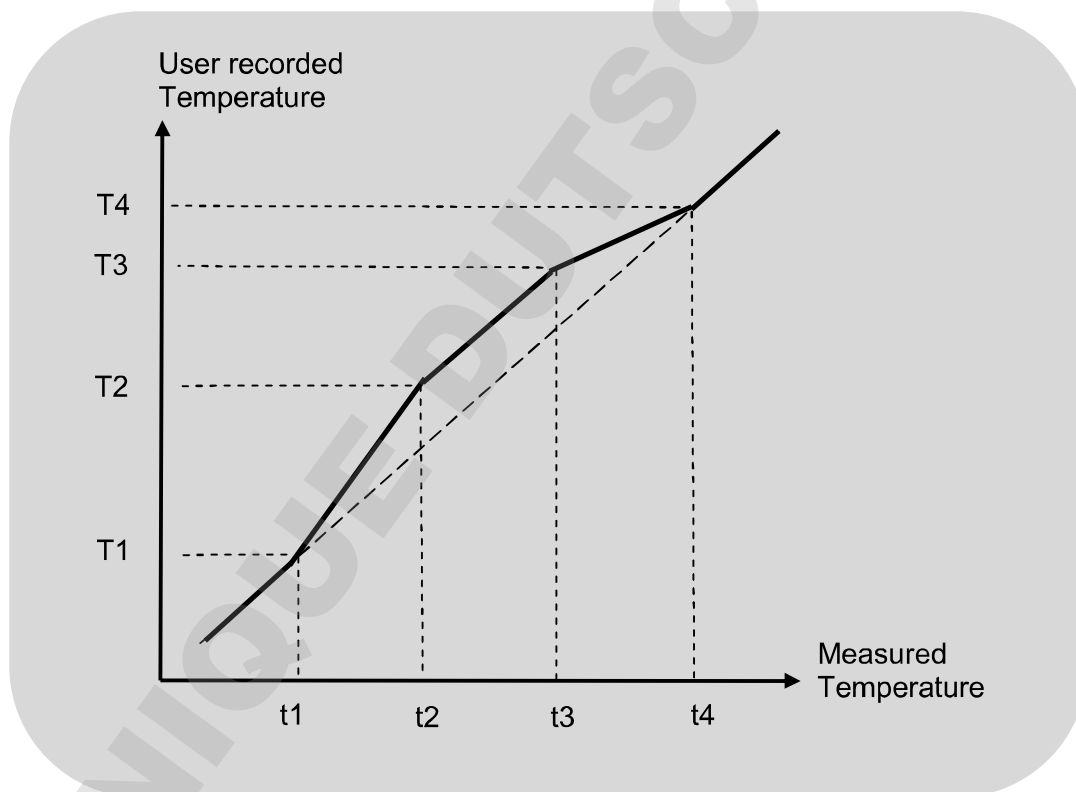

Calibration points must be a minimum of 5°C apart and there must be at least 20°C between the highest and lowest points. Any points added that do not match these criteria will not be accepted by the unit.

Once set, calibration points can be changed or deleted but a minimum of 2 points must remain.

Prior to calibration, ensure the probe type to be calibrated is selected, (internal or external); the bath is set to the desired temperature and has been stable at the temperature for at least 5 minutes.

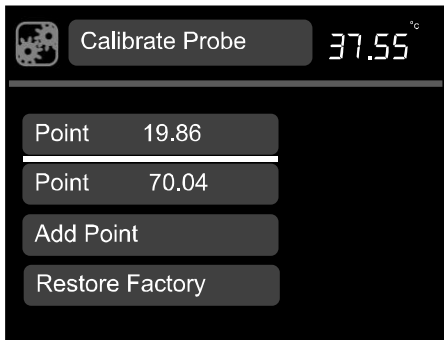

1. Press the **F** and **S** buttons simultaneously for 3 seconds.

The calibrate probe menu displays the factory defined calibration points and the current temperature of the bath in the top right corner of the screen.

2. Rotate the dial to highlight **add point**, press **S** to select.

The calibrate point menu is displayed. If an external probe has been selected the external probe icon will be displayed in the top left corner. Otherwise the settings icon will be displayed when calibrating the internal probe.

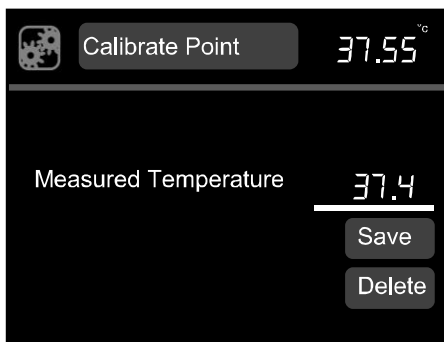

3. Rotate the dial to highlight **measured temperature**. Press **S** to select
4. Rotate the dial until the temperature being shown on the calibrated thermometer is displayed on screen. Press **S** to save the value.
5. Rotate the dial to highlight **save**, press **S** to select.

The display returns to the calibrate probe screen.

6. Press **F** to return to the home screen

*Further calibration points can be added by repeating steps 2 to 5. Calibration points can be deleted by selecting **delete** in the calibrate point screen.*

5.4.1 Restoring factory calibration settings

If the thermometer value is entered before the bath temperature is completely stable the calibration could be poor and liquid temperature readings will be incorrect. If the TX150/TXF200 is not in accordance with the thermometer following calibration then it may not have been successful and the unit should be reset, using the restore factory settings function.

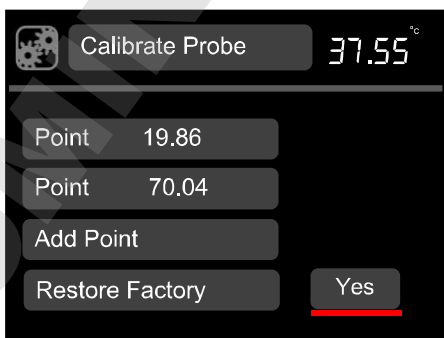

1. Press the **F** and **S** buttons simultaneously for 3 seconds.
2. Rotate the dial to highlight **restore factory**, press **S** to select.

***Yes/No** are displayed.*

3. Rotate the dial to toggle to **yes**, press **S** to select. *Factory calibration values are restored.*
4. Press **F** to return to the home screen

6.0 Technical specifications

6.1 Operating conditions

Ambient temperature range	5 to 40°C
Altitude above sea level	Up to 2,000m (6,500ft)
Operating environment	Indoor use only
Maximum relative humidity	80% RH up to 31°C decreasing to 50% RH at 40°C

6.2 Electrical details

Mains supply: 220-240V @ 50/60Hz or 110-120V @ 50/60Hz
Pollution degree: 2
Installation category: II

Mains supply voltage fluctuations are not to exceed $\pm 10\%$ of the nominal supply voltage.

6.3 Product performance

	TX150	TX150L	TXF200	TXF200L
Settable temperature range	-50°C to 150°C		-50°C to 200°C	
Stability (DIN 12876)	$\pm 0.01^\circ\text{C}$			
Uniformity (DIN 12876)	$\pm 0.05^\circ\text{C}$			
Max pump head pressure	310mBar		530mBar	
Max pump flow rate	18l/min		22l/min (adjustable)	
Max current consumption	9A	12.5A	9A	12.5A
Heater power	1.8kW	1.4kW	1.8kW	1.4kW

6.4 Bath accessories information

	ST5	ST12	ST18	ST26	ST38
Tank capacity (litres)	5	12	18	26	38
Liquid depth min/max (mm)	85/140	85/140	75/130	125/180	125/180

	P5	P12	P18
Tank capacity (litres)	5	12	18
Liquid depth min/max (mm)*	85/140	85/140	85/140

7.0 Technical Tips

7.1 Which water should you use in your bath?

For the long-term reliability of water baths it is important to use oxygenated water that is free from ions and minerals that can cause corrosion of stainless steel. We recommend the use of distilled water and de-ionised water from modern ion exchange systems that do not use salt back flushing to regenerate the ion-exchange cartridges.

Stainless steel is protected from corrosion by a layer of chromium oxide. If the layer is damaged, oxygen present in water can reform the oxide layer. If the water is still or de-oxygenated, and the oxide layer is damaged, ions can corrode the stainless steel tank. If a water bath has been unused for some time, or water boiled, we recommend changing to fresh distilled water or correct de-ionised water.

Water normally contains calcium or magnesium ions. De-ionised water has most ions removed as indicated by its conductivity level; the purer the water the lower the conductivity. It is important to use only de-ionised water from an ion exchange system with replaceable cartridges. Do not use de-ionised water generated from an ion-exchange system that incorporates a salt back-flush system to regenerate the ion-exchange resin as this can leave sodium ions that are very corrosive to stainless steel.

7.2 How to prevent rust in water baths

Most Grant tanks, as well as immersed parts, are made from type 304 stainless steel, an extremely versatile general purpose grade of stainless steel. It is the excellent forming characteristic that has made this grade dominant in the manufacture of laboratory and industrial water baths, as well as domestic sinks and saucepans. Type 304 stainless steel is highly suitable for applications where hygiene is important; it exhibits good heat resistance and excellent resistance to corrosion.

However, despite resistance to general surface corrosion, stainless steel is susceptible to specific types of corrosion, in particular pitting (small pin hole style corrosion) and stress corrosion cracking. It can also undergo general corrosion in specific environments, such as one containing hydrochloric or sulphuric acids.

Stainless steel is protected by its high content of alloying elements, primarily chromium and nickel. Chromium is the most important with respect to corrosion resistance, although the nickel assists in allowing the chromium to do its job. The chromium forms an oxide layer on the surface of the steel, which inhibits further oxidation. This layer adheres extremely well to the metal substrate, but it is essential that it remains intact, and must be protected from various forms of damage.

If the surface chromium oxide layer becomes damaged, oxygen present in water can partially reform the oxide layer, so it is advisable to ensure that water is always fresh and well oxygenated. Baths that will be out of use for an extended period should be emptied, and all moisture should be wiped from the bottom of the tank.

In some cases a brown layer may appear on the surface of a stainless steel tank. In most of these cases this is not rust, but it may be a surface deposit of minerals from the local water supply, or ferrous particles or salts that have fallen into the tank. These surface deposits can usually be removed by using a household cleaner such as Duraglit or Silvo metal polish.

7.3 How to prevent algae and bacteria

Water baths provide the ideal environment for the growth of micro-organisms. If left uncontrolled the growth of these organisms can result in a range of serious problems and health risks from pathogenic bacteria.

The growth of algae on the surface of parts will cause biofouling which can reduce performance. Micro-organisms that produce acidic metabolic by-products can cause bio-corrosion by depolarisation of metal surfaces.

There are a number of biocides available on the market.

8.0 Warranty information

When used in laboratory conditions according to this manual, this product is guaranteed for THREE YEARS against faulty materials or workmanship.

Extended warranty for years four and five can be purchased by contacting our sales department at labsales@grantinstruments.com.

9.0 Maintenance and service

9.1 Routine maintenance

The over-temperature cut-out on the TX150/TXF200 should be checked periodically by turning the over-temperature dial with a screwdriver anticlockwise until the alarm is triggered. The unit will sound a buzzer and "Overtemperature Alarm" will be shown on the display. The over-temperature dial should then be turned to 10°C above liquid temperature and the TX150/TXF200 powered off and back on to confirm that the cut-out can be reset correctly. If the alarm is triggered when the value indicated on the over-temperature dial is more than 10°C below the current temperature as indicated by the main display, then the unit should be checked by a competent person.

The float liquid level protection should also be checked periodically by lowering the level of liquid in the bath and noting that the "Low liquid alarm" is triggered with the top turn of the heater still immersed in the liquid. The float should also be checked periodically to ensure no limescale, dirt or debris could impede the operation at low liquid level.

When hoses are fitted to the pump they should be inspected periodically and replaced as necessary to avoid hose failure.

No other routine maintenance is required.

9.2 Cleaning

Clean the outside of the equipment with a damp cloth, using water only. Do not use chemical cleaning agents. Before using any other cleaning or decontamination method, check with Grant Instruments or your local representative to make sure that the proposed method will not damage the equipment. Scale on immersed parts can be removed using chemical de-scaling products designed for use on equipment that has metal parts.



De-scaling products may be toxic and manufacturer's instructions should always be followed

9.3 Fuses

The TX150/TXF200 fuses are internal and should not need to be replaced.

9.4 Replacing the mains cord

Any replacement mains cord used with the TX150 or TXF200 must meet the same specification as the one originally supplied with the unit to maintain the safety of the unit.

The cable must have the following markings; <HAR>, HO5VV-F 3Gx1mm² 90°C and be rated to carry 10A. The mains plug and IEC connector must carry approvals from a European certification body (e.g. BSI, VDE or equivalent).

9.5 Routine safety tests

If routine tests are to be made, we recommend a test of the integrity of the protective earth conductor and an insulation test at 500V DC. Routine flash tests are not recommended for any electrical equipment, because repeated high voltage tests degrade insulation materials.

9.6 Service

If service is required, switch off the unit and contact Grant Instruments or your local representative for repairs.

Please note, all returned units must be accompanied by a Return Materials Authorisation (RMA) number, obtainable by contacting the Grant service department (details below).

Service Department
Grant Instruments (Cambridge) Ltd
Shepreth
Cambridgeshire
SG8 6GB
UK





Tel: +44 (0) 1763 260 811
Fax: +44 (0) 1763 262 410
E-mail: labservice@grantinstruments.com





10.0 Optional accessories

A full listing of product accessories and options is available in the Grant Scientific Reference Catalogue (a copy of which is available upon request) and on the Grant website at www.grantinstruments.com.

11.0 Troubleshooting

Symptom	Possible cause	Action required
Temp continues to rise when not expected	Set temp is higher than liquid temp	Check that the bath set temperature is correct (see section 5.2.9).
Set temperature too restricted	Liquid type set does not allow required set point	Change to different liquid type (see section 5.3.4).
Temperature does not rise when expected	Set temp is lower than liquid temp Set temperature is too close to ambient	Check that the bath set temperature is correct (see section 5.2.9). Increase the set temperature (see section 5.2.9) or fit accessory cooling (see section 4.9).
Display shows "High Temperature Alarm"	High temperature warning alarm has tripped	Check that the bath set temperature is correct (see section 5.2.9). Check that high temperature alarm is correct (section 5.3.6). Check that the liquid level in the bath is adequate (see section 6.4 for minimum fill levels).
Display shows "Low Temperature Alarm"	Low temperature warning alarm has tripped	Check that the bath set temperature is correct (see section 5.2.9). Check that low temperature alarm is correct (section 5.3.6). Check that the liquid level in the bath is adequate (see section 6.4 for minimum fill levels).
Unit showing erratic temperatures	Calibration values not set correctly	Restore the factory calibration settings (see section 5.4.1) then re-calibrate if required (see section 5.4).
New calibration point is not saved	Incorrect calibration value	The temperature calibration point is less than 20°C from an existing calibration point – choose a higher temperature (see section 5.4). The measured liquid temperature is more than 5°C away from selected calibration temperature.
Only the Standby icon can be highlighted	Unit is in standby mode	Highlight and Select the Standby icon and Press "S" to exit Standby mode.
Icons can be highlighted but not selected	Program running	Wait until program has finished or stop program.

Symptom	Possible cause	Action required
Select a preset number but icon changes to “-“	Preset not setup The preset set temperature is not valid for the selected liquid	Select Presets in the Settings menu and configure a preset (see section 5.3.1). Select Liquid in the Settings menu and select a liquid which will operate at every target temperature (see section 5.3.4).
Select a program number but icon changes to “-“	Program not setup One or more program segments contain a target temperature which is not valid for the selected liquid	Select Programs in the Settings menu and configure a program (see section 5.3.2). Select Liquid in the Settings menu and select a liquid which will operate at every target temperature (see section 5.3.4).
Stirrer motor not rotating	Unit is in Standby Mode Stirring propeller or pump impeller is obstructed Faulty motor	Highlight the Standby Icon on the control screen and press S button to return to normal operation. Clear obstruction. Have a competent person check the motor or contact Grant.
Display shows “Over temperature Alarm”. 	Over-temperature cut-out has operated	Check the set temperature is correct and that the over-temperature cut-out temperature is set at least 5°C above the set temperature (see section 5.2.6 for setting instructions). If the over-temperature cut-out temperature is correctly set but the unit still shows a “Cut-Out” alarm then the unit has an internal fault and must be repaired before it is used again.
Display shows “Low liquid Alarm”. 	Liquid level has dropped below minimum level	Check that the liquid level in the bath is adequate (see section 6.4 for minimum fill levels).
Display shows “Set a valid temperature”. 	Liquid selection has been changed and the previous set temperature is not valid for the new liquid	Highlight the set temperature icon (which will be showing -.-) and set the required temperature.
Display shows “Internal/External Temp Diff Too Big”. 	There is a temperature difference of more than 10 degrees between the internal and external probe	Check the external probe is properly connected at the rear panel. Check the external probe is correctly positioned in the bath liquid and circulation is not restricted. If the external probe is not required, select the internal probe using the Settings menu.

Symptom	Possible cause	Action required
Display shows "Internal Temperature Probe Fault" 	Faulty temperature probe	Have a competent person check the probe for an open or short circuit fault or contact Grant.
Display shows "External Temperature Probe Fault" 	External temperature probe not plugged in Faulty temperature probe	Check the external probe is properly connected at the rear panel. Have a competent person check the probe for an open or short circuit fault or contact Grant.
Display shows "Program Fault" 	One or more program segments contains an invalid setting or could not be read from the memory	Reload the program if it came from LabWise or edit each segment on the unit (TXF200 only)
Display shows "Overheating- Power reduced" 	Heating water at or near to boiling without lid Heating very large volumes of liquid with large thermal losses	Add a lid to reduce thermal losses and leave unit running with the "Overheating" warning present. If the alarm has not cleared within 1 hour contact Grant. Add measures to reduce thermal losses and leave unit running with the "Overheating" warning present. If the alarm has not cleared within 1 hour contact Grant.
Display shows "Service required 01"	Faulty fuse(s), relay or heater element	Have a competent person check the product or contact Grant.
Display shows "Service required 02"	Pump or propeller is obstructed Faulty motor	Remove obstruction. Have a competent person check the product or contact Grant.
Display shows "Cross-check Failure"	PCB fault	Have a competent person check the product or contact Grant.

For any other errors or service requests, please contact Grant Instruments service department.