

NOT TO SCALE

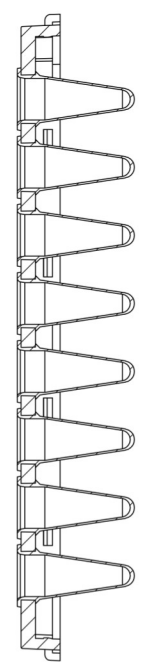

Section X-X

Copyright Thermo Fisher Scientific
 This drawing and/or any technical information relating to it is issued in strict confidence and may not be reproduced or used for manufacture without written permission. Upon receipt of which it is the users responsibility to seek confirmation of any dimensions and production tolerances.

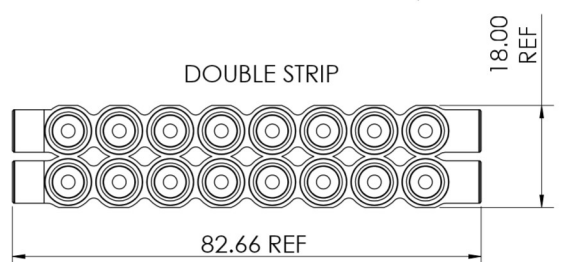
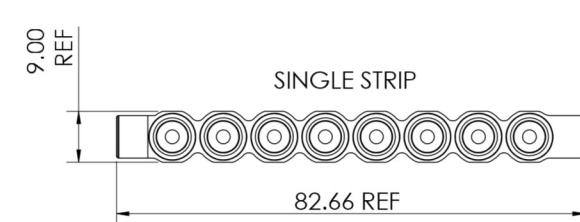
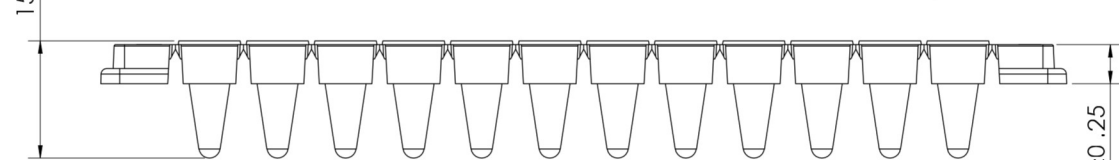
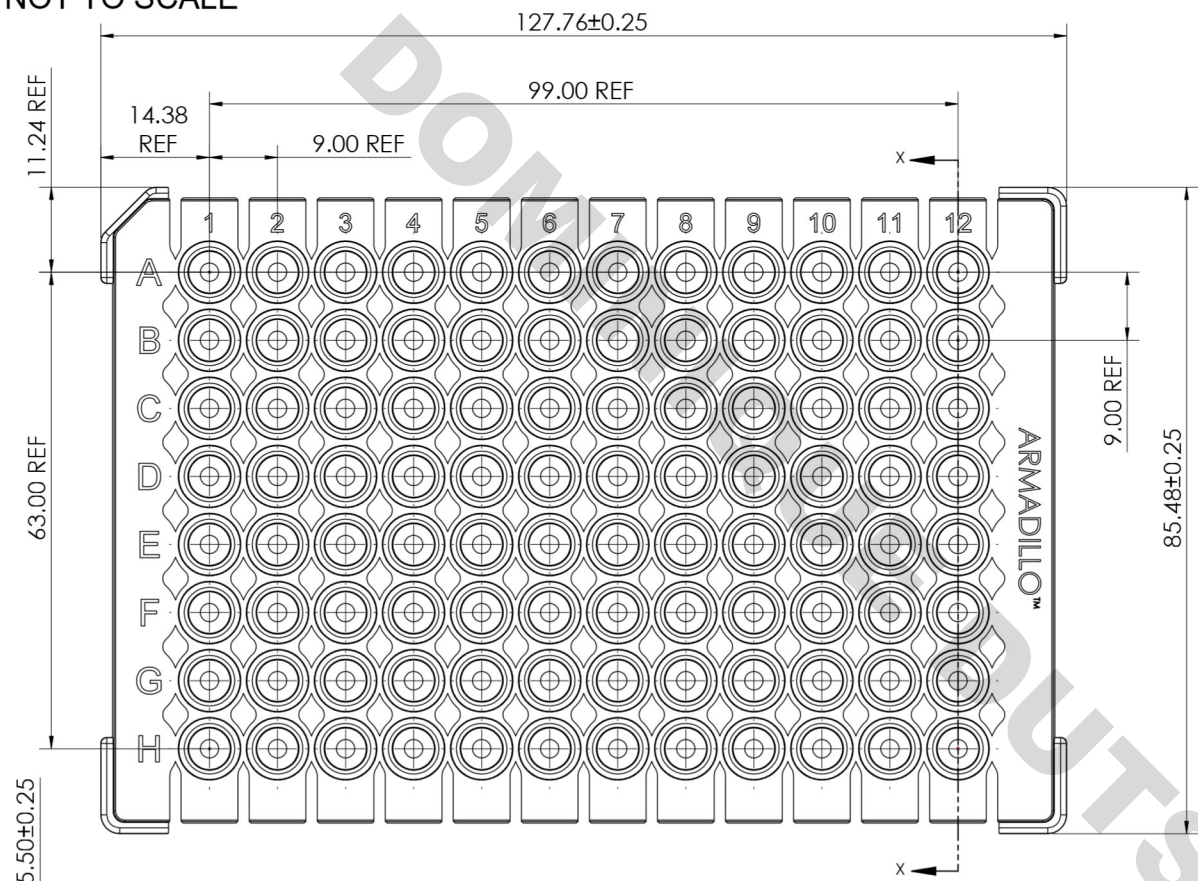
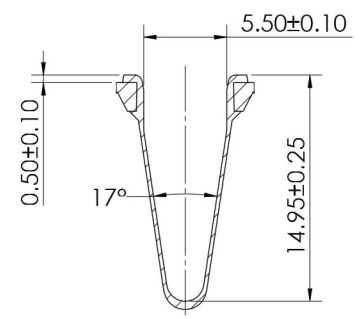

VIAL FORM

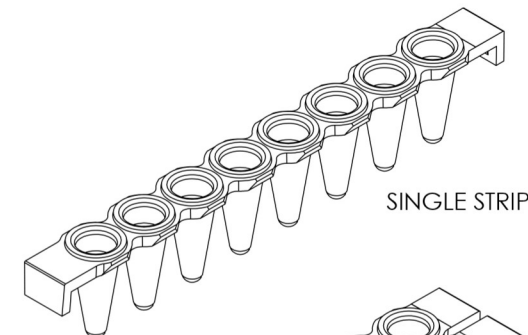

SINGLE STRIP

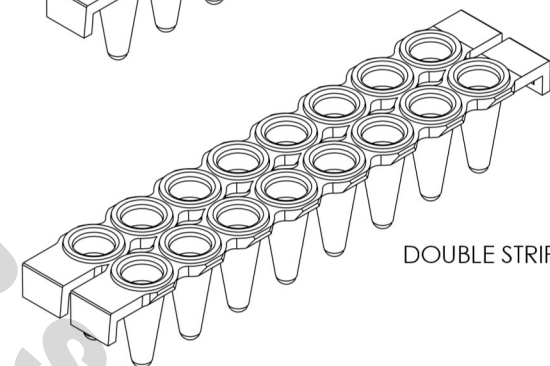

DOUBLE STRIP

TITLE		
Armadillo™ 96-Well Low Profile PCR Strip Plate		
DRG. NO.	ISSUE	DATE
AB-2696/AB-3696	A	7/26/21

All dimensions in mm