

NOT TO SCALE

Copyright Thermo Fisher Scientific  
 This drawing and/or any technical information relating to it is issued in strict confidence and may not be reproduced or used for manufacture without written permission. Upon receipt of which it is the users responsibility to seek confirmation of any dimensions and production tolerances.

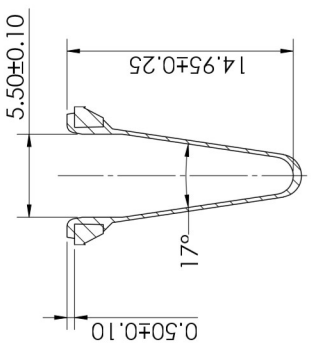

VIAL FORM

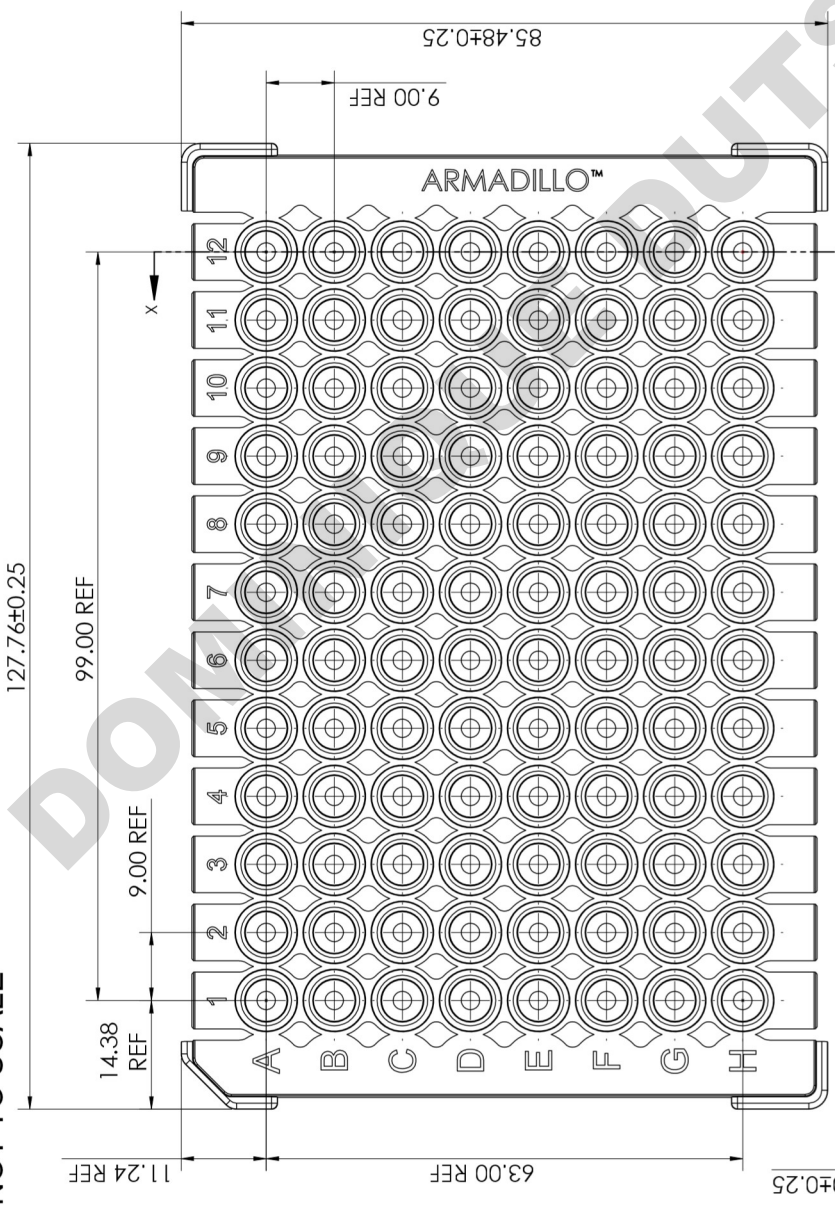
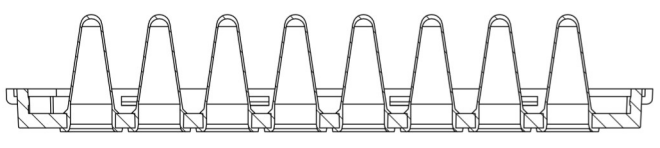

Section X-X

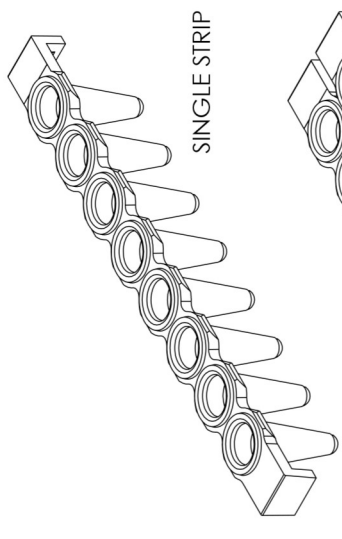

SINGLE STRIP

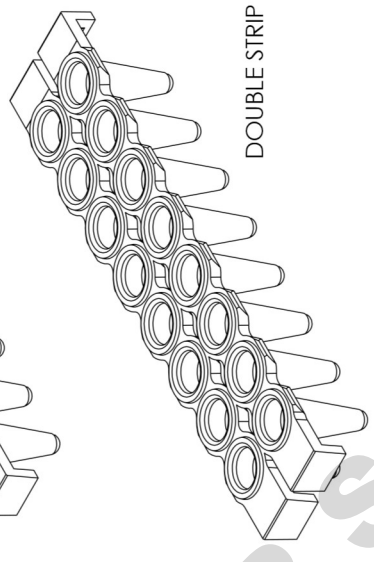

DOUBLE STRIP

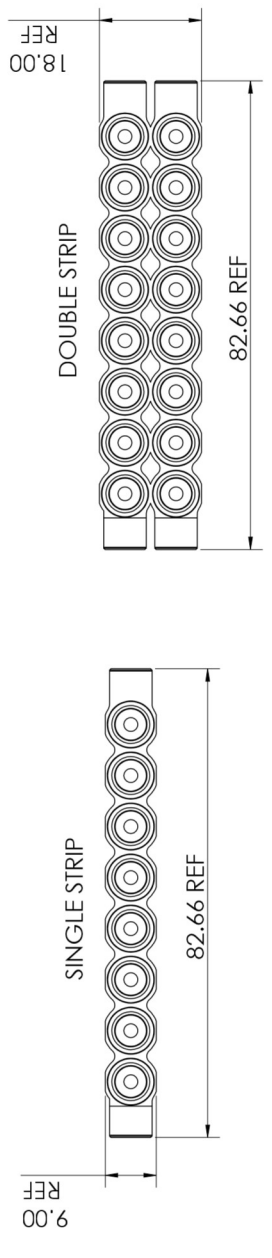
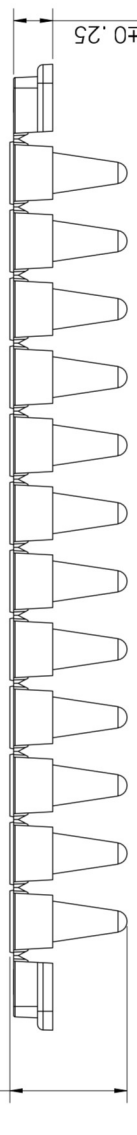

TITLE

Armadillo™ 96-Well Low Profile  
 PCR Strip Plate

DRG. NO.

AB-2696/AB-3696

ISSUE

A

DATE

7/26/21

All dimensions in mm