

Valid for Item-No.: 115261, 115262

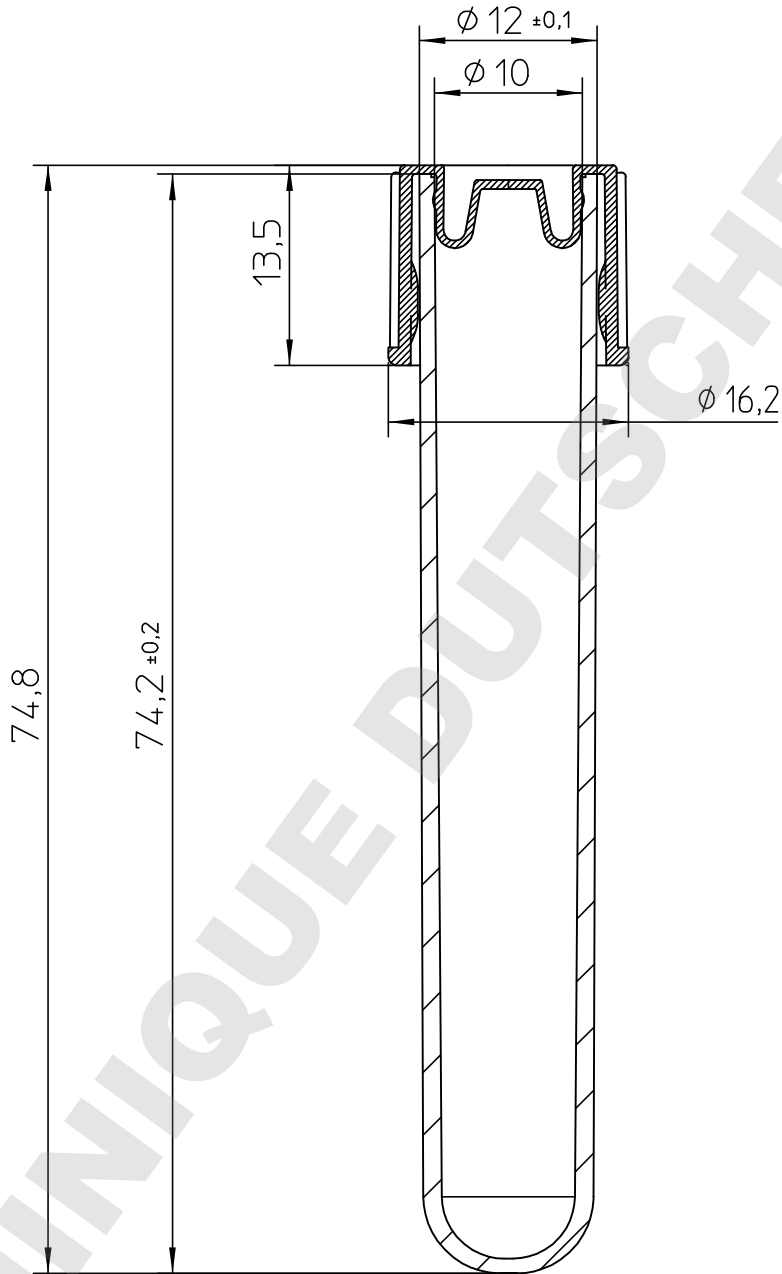

"All dimensions in mm"

Customer drawing subject to change without notice!

Uncontrolled Copy

Prior Issue	Drawn	Approved	Released	<small>CONFIDENTIAL: Information contained in this document or drawing is confidential and proprietary to Greiner Bio-One GmbH. This document may not be reproduced for any reason without written permission from Greiner Bio-One GmbH. All rights of design, invention, and copyright are reserved.</small>
Revision 2	Date 2011/03/11	Date 2014/07/07	Date 2014/07/07	
Date 2013/10/18	Name falter	Name schwarzj	Name sonntag	