

# Consumables.

PERFORMANCE ASSURED. QUALITY ASSURED. APPLICATION ASSURED.

DOMINION DEUTSCHER SAS



# Every Test.

# Empowered.

“We focus our efforts on the optimization of cell culture media for our cell lines, to ensure that we have the best possible conditions for high growth and productivity. We require sterile consumables to carry out a range of pipetting scripts, blending the media components using the Tecan Freedom EVO®. The sterile tips have enabled us to extend the volume range that we can use, eliminating the need to execute multiple aspirations and reducing the likelihood of microbial contamination.”

Steven Byrne,  
Biopharmaceutical company, Australia



## Safety and quality for optimal performance.

At Tecan, we work continually to ensure that our instruments meet your application requirements. We offer a broad range of consumables tailored to your application and automation needs.

### DISPOSABLE TIPS

Tip quality is a crucial factor if you are to run tests reproducibly, sample after sample. Installation Qualification and Operational Qualification (IQ/OQ) of your system with Tecan disposable tips means you are assured of optimum system performance – a clear advantage for your lab.



### LABWARE

Labware should work seamlessly with your applications and automation platform. Our high quality range is tailored to your needs and designed specifically for the Fluent® and Freedom EVO liquid handling platforms.



### FUNCTIONAL CONSUMABLES

A unique range that adds value to your applications, providing assured performance for pipetting, quality control and LC-MS sample prep.

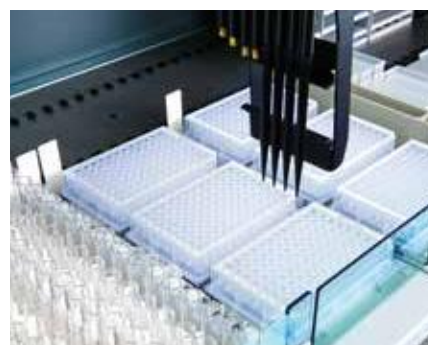

## LEADING WITH NEW SOLUTIONS

### Performance

We introduced the Nested MCA 96 and LiHa Disposable Tips – available in 350 µl and 10 µl volumes – for high throughput labs, significantly increasing on-deck tip capacity and walkaway times.

### Quality

Together with our partner Artel, we launched the QC Kit™ to assure the performance of your liquid handling. This solution will help you to ensure quality and regulatory compliance.

### Application

The AC Extraction Plate™ is our revolutionary, automation-friendly device to streamline sample preparation for LC-MS analysis of small molecules.



“We’ve discovered two advantages of Tecan’s disposable tips over other suppliers; precise positioning of rack wells minimizes mechanical abrasion to the adapters, and the consistent size and shape of tips helps to avoid labware collisions, especially when working in 384-well microplates.”

Junfen Jiang,  
Shanghai Chempartner Co Ltd, China



## You're assured.

### PERFORMANCE ASSURED

#### On-site and across sites

At Tecan, we work continually to ensure that your Tecan instrument meets your application requirements. We provide Installation and Operational Qualifications of your Tecan instrument, together with your choice of Tecan disposable tips. The performance of the entire system is dependent on every aspect, right down to each individual tip.



### QUALITY ASSURED

#### All-round quality you can rely on

We fully automate our liquid handling tip manufacturing within a controlled environment, using state-of-the-art production processes and integrated quality control procedures. For instance, each and every LiHa disposable tip undergoes automated visual inspection to check all functional aspects during production, so you can rely on consistently accurate and precise pipetting.



**Discover the performance of our disposable tips (CV and accuracy) at [www.tecan.com/disposablestips](http://www.tecan.com/disposablestips)**

Our entire value chain, from production to warehousing, is ISO 9001 and ISO 13485 compliant for most of our products.

### APPLICATION ASSURED

#### Whatever your application, we have a purity level to suit

Every lot of Tecan Pure and Tecan Sterile tips has been tested by an independent laboratory to guarantee the purity of each product. Tecan Sterile products are more than pre-sterilized, they remain sterile through shipment and storage ensuring a sterile product when you are ready to use it. Each case includes a Certificate of Conformity (CoC).



### WHATEVER YOUR APPLICATION, WE HAVE A PURITY LEVEL TO SUIT

	Tecan Standard	Tecan Pure	Tecan Sterile
<b>Application examples</b>	ELISA Sample handling Biochemical screening	Genomics research Forensics Molecular diagnostics	Cell biology Microbiology Cell-based screening
<b>Tecan Standard quality</b>	✓	✓	✓
<b>Human DNA free</b>	-	✓	✓
<b>PCR inhibitor free</b>	-	✓	-
<b>RNase/DNase free</b>	-	✓	✓
<b>Pyrogen/endotoxin free</b>	-	-	✓
<b>Sterile</b>	-	-	✓

### DISPOSABLE TIP PURITY LEVEL AND FILTER RECOMMENDATIONS FOR SELECTED APPLICATIONS

#### Applications/lab types

	Purity Level	Filter Type
Genomics/NGS	Pure	Filtered
ELISA	Standard	Filtered
Mass spec sample prep	Standard	Non-filtered
Cell biology	Sterile	Filtered
Biobanking	Pure or Sterile	Filtered
Human identification - HID	Pure	Filtered
Protein sciences	Standard	Non-filtered

**For more detailed information, visit [www.tecan.com/disposablestips](http://www.tecan.com/disposablestips)**



“We have not had any particular concerns with our consumables orders in the past 10 years. Requests for quotations have been responded to quickly, delivery times have always been very good, we have never had problems with goods being out of stock, and the quality is highly satisfactory.”

Florence H,  
Animal health company, France



## On-demand delivery.

Tecan operates a worldwide distribution network for consumables to ensure a safe supply for its customers around the globe. Receiving the consumables you need in a timely manner is essential when sensitive samples are at stake and time-to-results is critical. With five strategically situated warehouses worldwide, we can assure security of supply and fast delivery – when and where you need it.

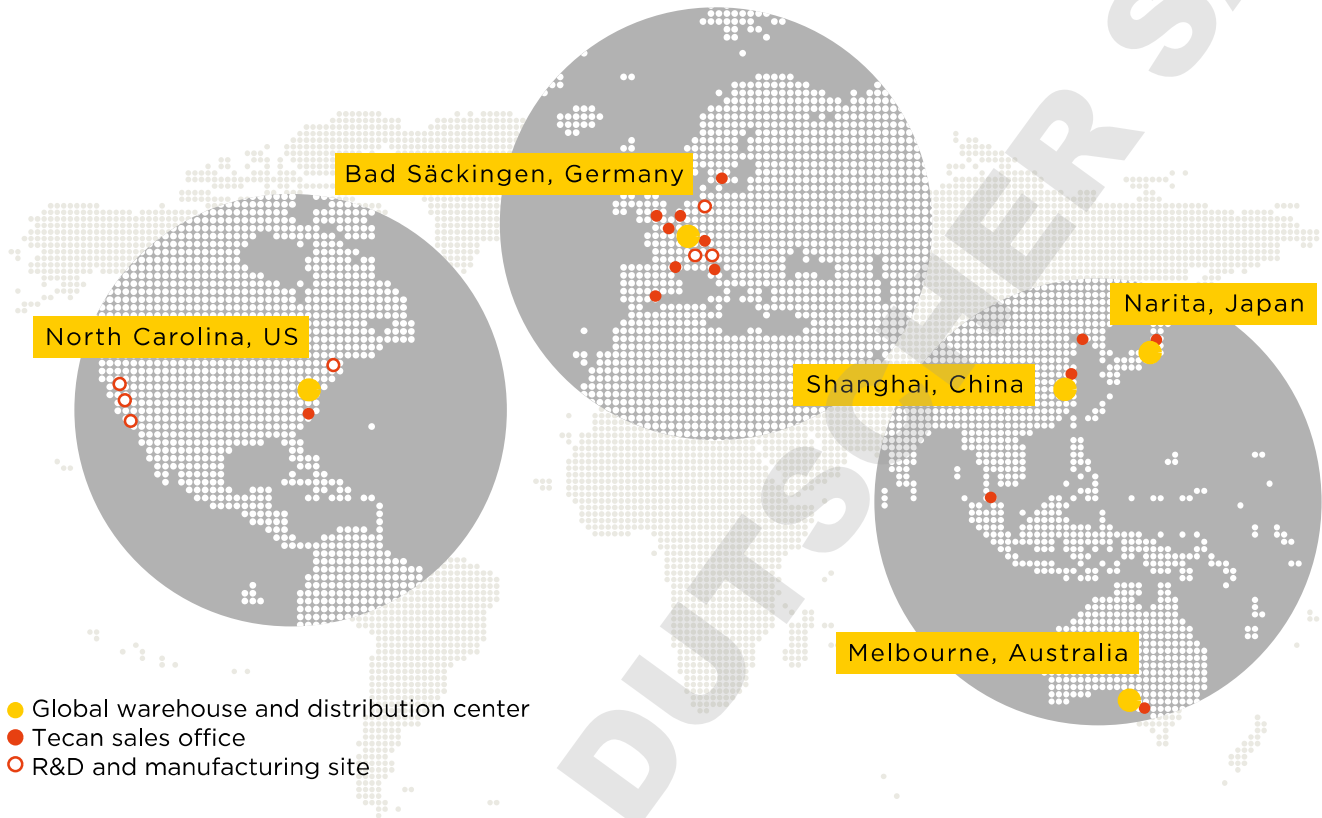

### Tecan Group

#### Global headquarters

Tecan Group Ltd.	Tecan Switzerland Ltd.	Tecan Austria GmbH	Tecan Systems, Inc.	IBL International GmbH*
Seestrasse 103	Seestrasse 103	Untersbergstrasse 1a	2450 Zanker Road	Flughafenstrasse 52 a
CH-8708 Männedorf	CH-8708 Männedorf	5082 Grödig	San Jose, CA 95131	22335 Hamburg
Switzerland	Switzerland	Austria	USA	Germany
T +41 44 922 88 88	T +41 44 922 81 11	T +43 6246 8933 0	T +1 408 953 3100	T +49 40-53 28 91-0
F +41 44 922 88 89	F +41 44 922 81 12	F +43 6246 72770	F +1 408 953 3101	F +49 40-53 28 91-11

\*IBL International GmbH is a Tecan Group company.

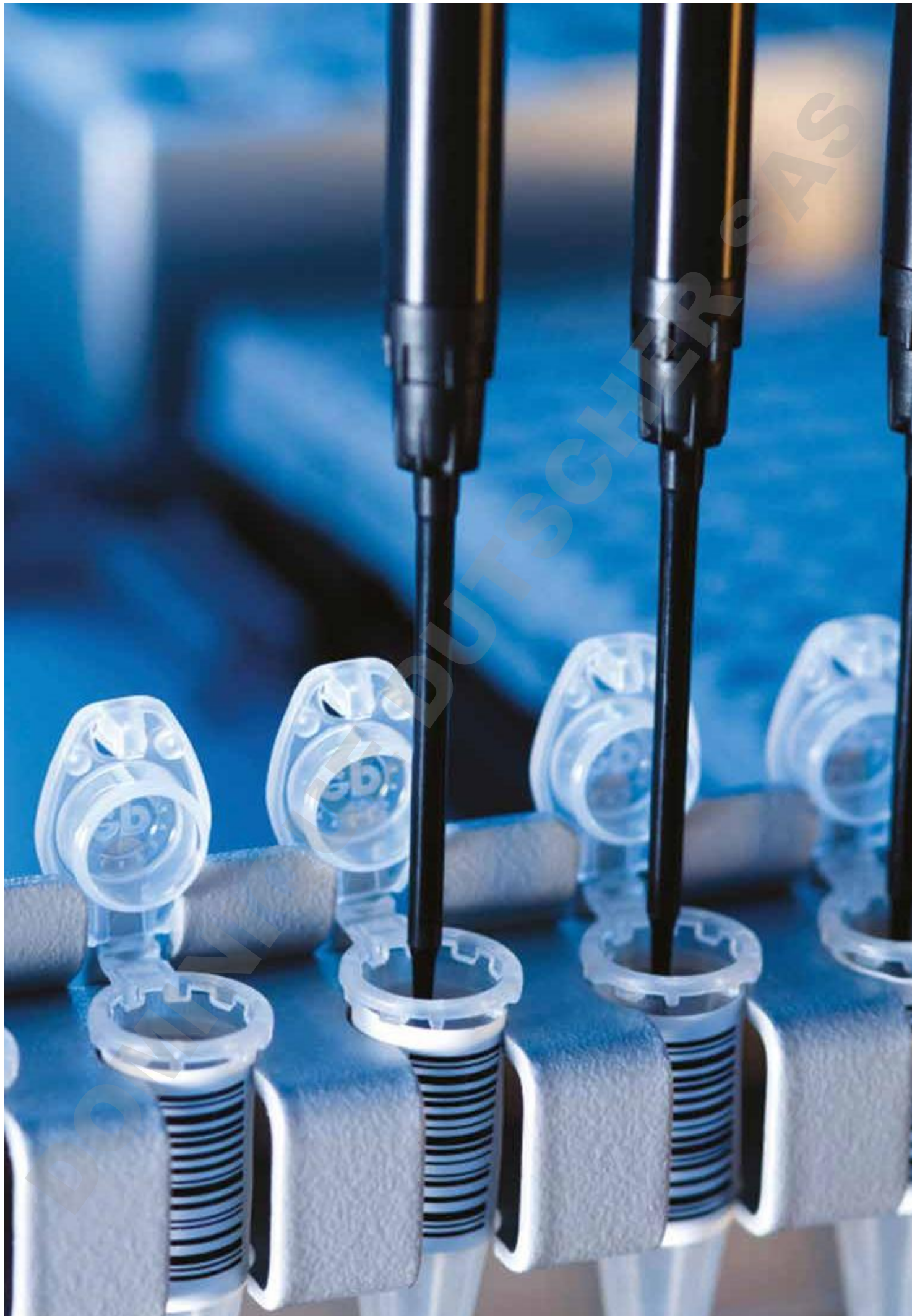



## Product Index

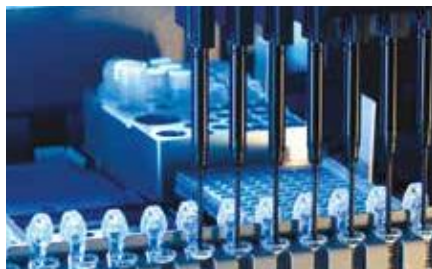

### Conductive liquid handling disposable tips

Carefully designed, produced and validated to ensure reliable performance using Liquid Handling Arms™ and Air FCAs™ on Tecan platforms.

**Pages 10-11**



### Clear Liquid handling disposable tips

Selection of clear LiHa tips specifically validated for Air LiHa™, Air Flexible channel arms, and Cavro Air displacement pipettor arms.

**Pages 12-13**



### MCA 96 Disposable Tips

Designed, validated and manufactured to ensure optimal performance of your MultiChannel Arm™ 96.

**Pages 14-15**



### MCA 384 Disposable Tips

Specifically designed to support the flexibility of the MultiChannel Arm™ 384 pipetting option.

**Pages 16-17**

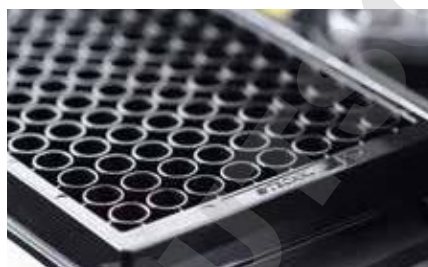

### Tecan Microplates: Biochemical Assay Plates

Black and white biochemical assay plates are designed for fluorescence and luminescence measurement assays.

**Pages 18-19**



### Tecan Microplates: Cell Culture Plates

Tissue culture-treated (TC-treated), sterile cell culture plates with individual lids for confluence and bottom-reading fluorescence measurements in cell-based applications.

**Pages 20-21**



### Reagent troughs

A variety of shapes and volumes to fit your Fluent or Freedom EVO application needs.

**Pages 22-23**



### AC Extraction Plate™

Sample preparation for LC-MS made easy.

**Pages 24-25**



### QC Kit™

Validated volume transfer verification tool for Fluent and Freedom EVO liquid handling platforms.

**Pages 26-27**



# Conductive





# LiHa disposable tips.

“Using consumables that have been validated by Tecan is important to us. It streamlines communication with the service team when we have questions, and knowing we can trust Tecan disposable tips to perform consistently takes a major variable out of protocol development and optimization.”







Stefanie K,  
Biotech company, USA



## Standard tray LiHa disposable tips

Application examples	Tecan Standard		Tecan Pure	
	ELISA Sample handling Biochemical screening		Genomics research Forensics Molecular diagnostics	
	Non-filtered	Filtered	Non-filtered	Filtered
10 µl 	-	-	30104803	30104804
50 µl 	-	-	30032115	30032114
200 µl 	10612552	10612553	30000627	30000629
1000 µl wide bore 	-	-	-	30115239
1000 µl 	10612554	10612513 10612555	30000630	30000631

## ANSI/SLAS-format box and nested LiHa disposable tips

Application examples	Tecan Pure		Tecan Sterile	
	Genomics research Forensics - Molecular diagnostics		Cell biology - Microbiology Cell-based screening	
	Non-filtered	Filtered	Non-filtered	Filtered
10 µl 	30104973	30104974	30104975	30104976
10 µl nested 	30104977	30104978	-	30104979
50 µl 	30057811	30057813	30057818	30057819
200 µl 	30057814	30057815	30057820	30057821
350 µl nested 	30083400	-	30083401	-
1000 µl 	30057816	30057817	30057822	30057823
5000 µl 	30059897	30065423	-	30059898

Tecan offers two ANSI/SLAS footprint tip boxes to place the ANSI/SLAS refill tips in. See below which tips can be used with which box:

	10 µl	50 µl	200 µl	1000 µl
<b>Small box</b>	30104973	30057811	30057814	-
Part no. 30058506	30104974	30057813	30057815	
<b>Big box</b>	-	-	-	30057816
Part no. 30058507				30057817

### Materials

Tips: conductive polypropylene (PP)

Filters: polyethylene (PE)

Trays: polycarbonate (PC) for standard tray  
polypropylene (PP) for ANSI/SLAS tray

Box: polypropylene (PP)

### Dimensions

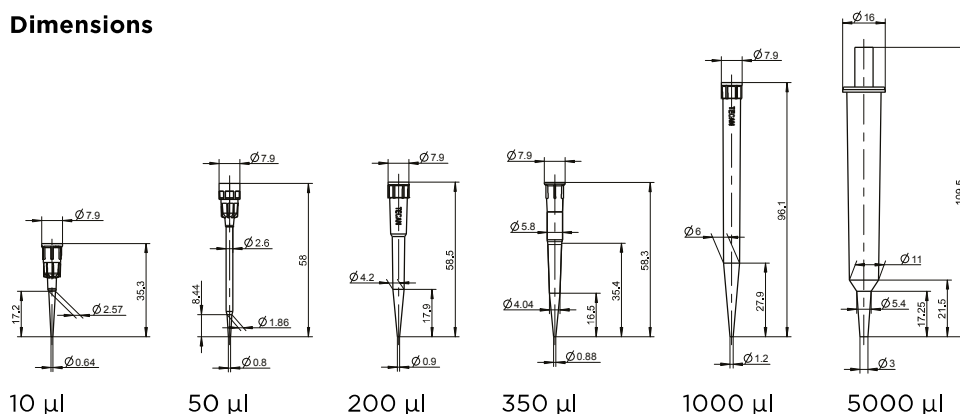

If a chosen product is not available online, contact your local Tecan sales office.



**Clear**

**LiHa disposable tips.**





## Standard tray LiHa disposable tips

Features	Tecan Standard		Tecan Pure	
	Non-filtered	Filtered	Non-filtered	Filtered
50 µl 	-	-	30126096	30126097
200 µl 	30126017	30126018	Coming soon	Coming soon
1000 µl 	30126019	30126020	Coming soon	Coming soon

Released for use only with Freedom EVO Air Liquid Handling Arm™, Fluent Air FCA™ arm and Cavo® ADP and not for conductive liquid level detection. Not intended for Tecan instrument qualification

### Materials

Tips: clear, non-conductive, polypropylene (PP)

Filters: polyethylene (PE)

Trays: polycarbonate (PC)

### Dimensions

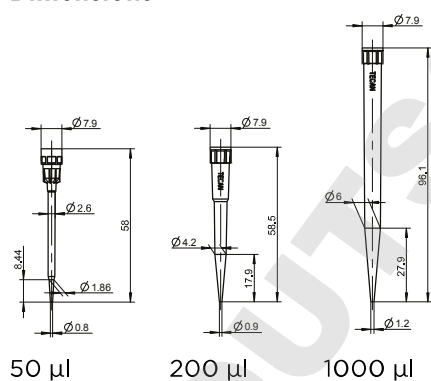



MCA 96

Disposable Tips.

“We are working on automated high throughput genotyping and multiplexed immunological assays, and we rely on Tecan to provide reproducible and reliable disposable tips.”

Christophe Marquette,  
Université Lyon, France



## MCA 96 Disposable Tips in ANSI/SLAS-format boxes



	Tecan Pure		Tecan Sterile	
<b>Application examples</b>	Genomics research Forensics Molecular diagnostics		Cell biology Microbiology Cell-based screening	
<b>Features</b>	Non-filtered		Non-filtered	Filtered
50 µl	30038606		30038607	30038608
100 µl	30038611		30038612	30038613
200 µl	30038616		30038617	30038618*
200 µl wide bore	30050348		-	30050349*
500 µl	30046341		-	30046342**

\*Maximum pipetting volume of 150 µl. \*\*Maximum pipetting volume of 400 µl.

## Nested MCA 96 Disposable Tips in ANSI/SLAS-format boxes



	Tecan Pure		Tecan Sterile
<b>Application examples</b>	Genomics research Forensics Molecular diagnostics		Cell biology Microbiology Cell-based screening
<b>Features</b>	Non-filtered (Te-Stack™)	Non-filtered (passive stack)	Non-filtered (passive stack)
50 µl	30038610	30038609	30048822
100 µl	-	30038614	30048823
200 µl	30038620	30038619	30048824

### Materials

Tips: polypropylene (PP)

Filters: polyethylene (PE)

Trays: conductive polypropylene (PP)

Box: polypropylene (PP)

Lids: polypropylene (PP)

### Dimensions

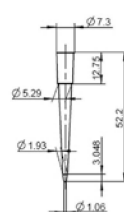
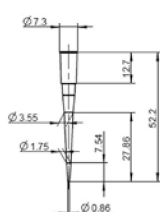
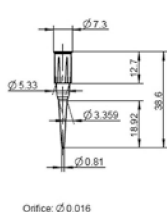

The MCA96 pipetting head is for research use only.

If a chosen product is not available online, contact your local Tecan sales office.



# MCA 384

## Disposable Tips.

“We use Tecan disposable tips for cell-based assays in the research phase of drug discovery. These tips are essential for our assays, enabling us to add samples to every individual well without errors, thanks to the advantageous geometry of Tecan’s disposable tips.”

Yasuyuki D,  
Pharma company, Japan



## MCA 384 Disposable Tips in ANSI/SLAS-format boxes



	Tecan Pure	Tecan Sterile	
<b>Features</b>	Non-filtered	Non-filtered	Filtered*
15 µl	30051802	30051803	30051804
50 µl	30051805	30051806	30051807
125 µl	30051808	30051809	30051810

\*Maximum pipetting volume 14.5, 40 and 110 µl respectively.

### Proprietary sealing system

The advanced design of MCA 384 disposable tips incorporates multiple stabilization guides and flexible sealing rings to provide excellent seal integrity without the use of O-rings. This patented sealing system ensures accurate, reproducible low volume pipetting across a broad volume range, offering a reliable solution to maximize productivity, while reducing maintenance requirements.

Sealing rings

Seat rings

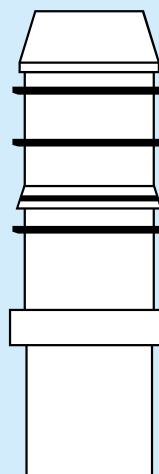

### Materials

Tips: polypropylene (PP)  
 Filters: polyethylene (PE)  
 Box: polypropylene (PP)  
 Lids: polypropylene (PP)

### Dimensions

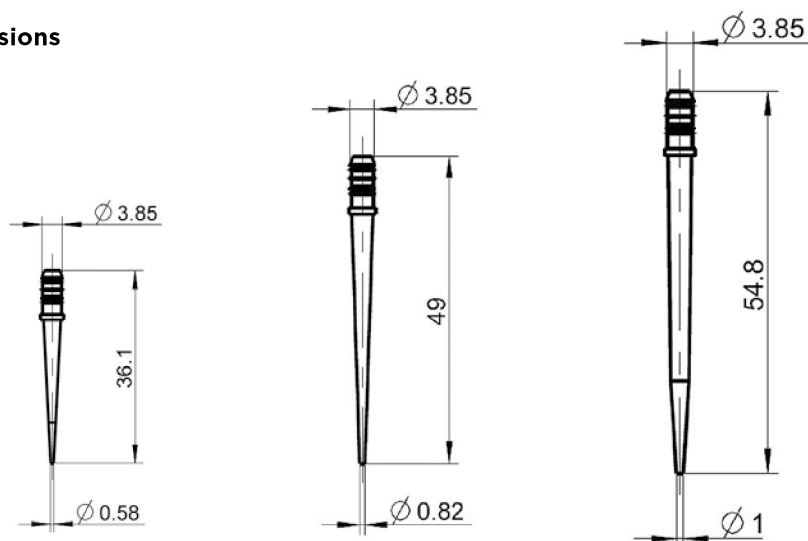

**Tecan Microplates.**

**Biochemical Assay Plates.**

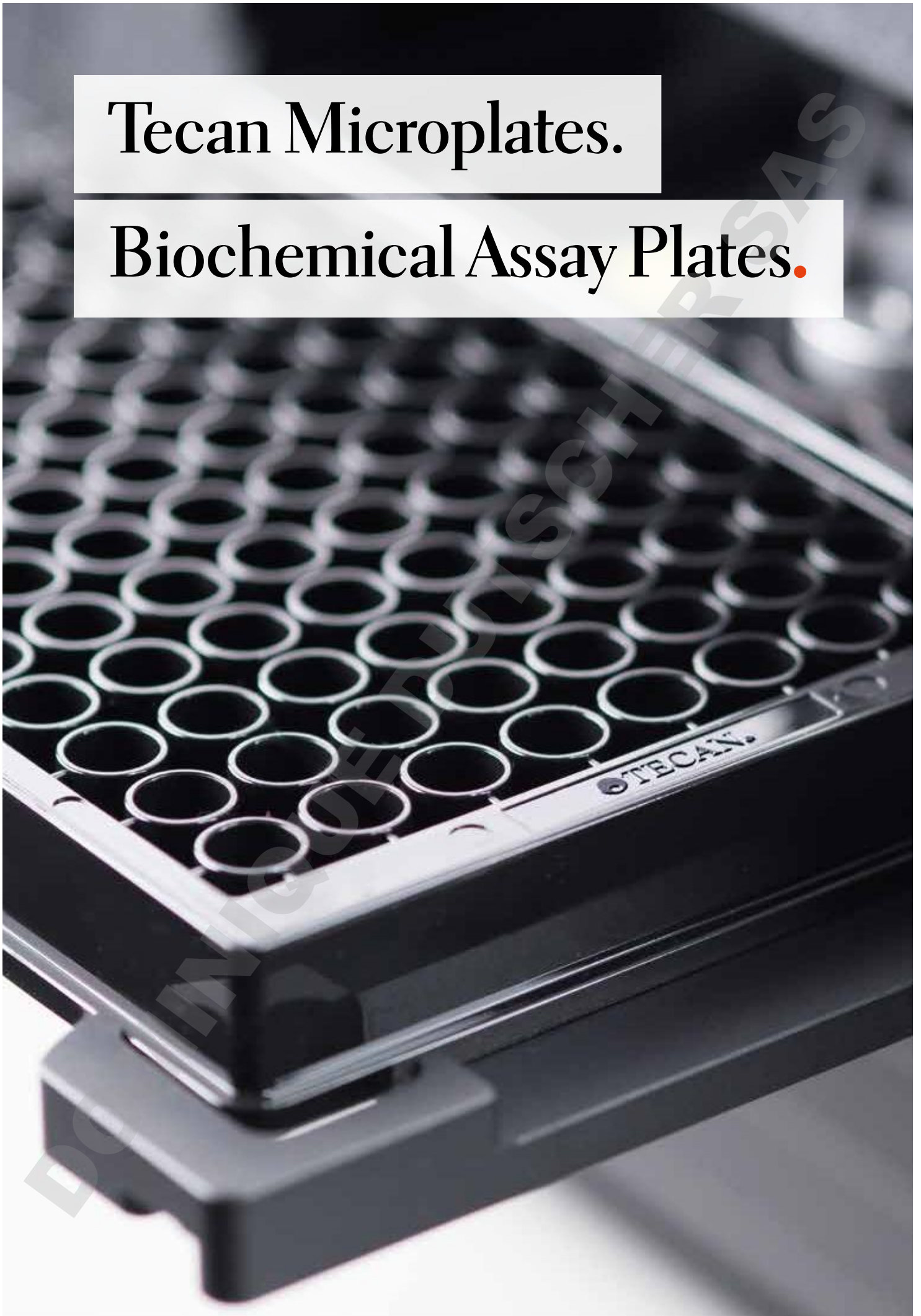



**Tecan Microplates are the latest addition to the Tecan consumables portfolio. We offer a selection of polystyrene, medium-binding ANSI/SLAS-format microplates compatible with Tecan instruments.**

- Optimal plate height and manufacturing tolerances allow reader optics to be as close to the plate as possible, avoiding well-to-well signal crosstalk.
- Low auto-phosphorescence of the white biochemical plates helps to reduce pre-measurement incubation times.
- The unique combination of black microplates and black lids allows uninterrupted measurement of light-sensitive assays using Spark®'s unique Lid Lifter™ system.

**Biochemical Assay Plates**

For fluorescence and luminescence measurement assays



**96-well, black, flat bottom**

10 pcs/bag, 40 pcs/box  
Part no. 30122298



**384-well, black, flat bottom**

10 pcs/bag, 40 pcs/box  
Part no. 30122299



**96-well, white, flat bottom**

10 pcs/bag, 40 pcs/box  
Part no. 30122300



**384-well, white, flat bottom**

10 pcs/bag, 40 pcs/box  
Part no. 30122301



**Biochemical assay plate lids, clear**

20 pcs/bag, 80 pcs/box  
Part no. 30122308



**Lid Lifter discs**

50 pcs/box  
Part no. 30090494



**Biochemical assay plate lids, black**

20 pcs/bag, 80 pcs/box  
Part no. 30122309

**We are offering a 20% discount on your first order!**



**Tecan Microplates.**

**Cell Culture Plates.**





## A collection of tissue culture-treated (TC-treated), sterile cell culture plates with individual lids for confluence and bottom-reading fluorescence measurements in cell-based applications.

- Developed and tested to work in combination with the imaging algorithms of our multimode readers, offering assured performance.
- Microplate well diameter is optimal to work with the Spark system's bright field imaging module – critical for confluence assessments.

### Cell Culture Plates

A collection of tissue culture-treated (TC-treated), sterile cell culture plates with individual lids for confluence and bottom-reading fluorescence measurements in cell-based applications.



#### **24-well, clear with lid, flat bottom, TC-treated, sterile**

Individually packed,  
100 pcs/box  
Part no. 30122302



#### **96-well, clear with lid, flat bottom, TC-treated, sterile**

Individually packed,  
100 pcs/box  
Part no. 30122304



#### **48-well, clear with lid, flat bottom, TC-treated, sterile**

Individually packed,  
100 pcs/box  
Part no. 30122303



#### **384-well, clear with lid, flat bottom, TC-treated, sterile**

8 pcs/bag, 32 pcs/box  
Part no. 30122305



#### **96-well, black with lid, clear flat bottom, TC-treated, sterile**

8 pcs/bag, 32 pcs/box  
Part no. 30122306



#### **384-well, black with lid, clear flat bottom, TC-treated, sterile**

8 pcs/bag, 32 pcs/box  
Part no. 30122307

**We are offering a 20% discount  
on your first order!**



# Reagent Troughs.

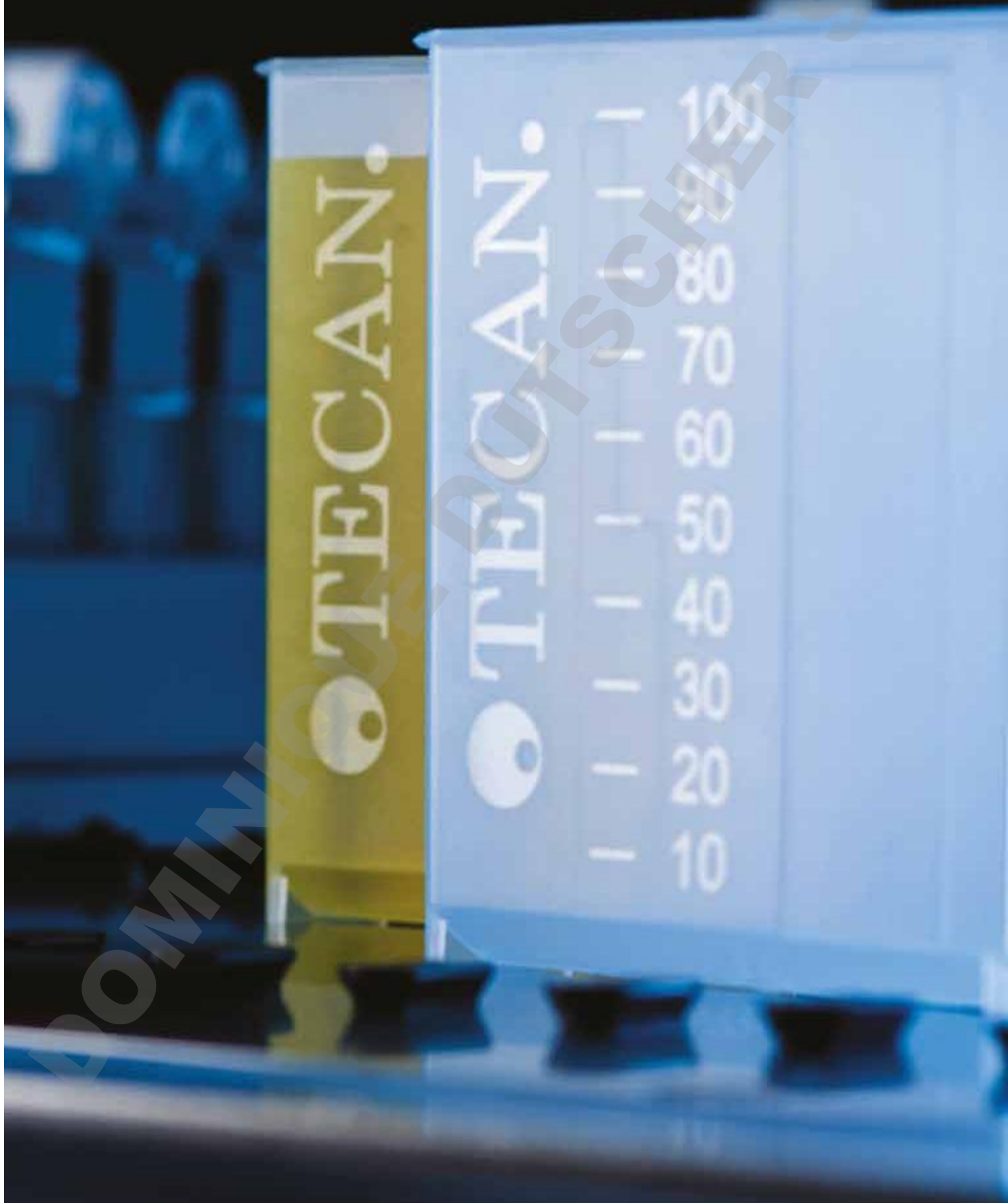



## Troughs

Tecan offers a wide range of disposable troughs to optimize the performance and productivity of its liquid handling platforms.



### 100 ml disposable reagent trough

Polypropylene, natural  
108 troughs  
Tecan Sterile  
Part no. 10613048



### 100 ml disposable reagent trough

Polypropylene, gray  
108 troughs  
Tecan Standard  
Part no. 10613049



### 25 ml disposable trough for maximum reagent recovery

Polypropylene, gray  
120 troughs  
Tecan Pure  
Part no. 30055743



### Cover for 100 ml and 25 ml disposable troughs

Polyethylene, black  
6 covers  
Part no. 10612548



### Lid for 25 ml trough

Polyethylene, natural  
100 lids  
Part no. 30057830



### 250 ml disposable reagent trough

Polypropylene, natural  
50 troughs  
Part no. 10619191



### 200 ml disposable reagent trough

Polypropylene, natural  
32 troughs  
Part no. 10760646



### 200 ml disposable reagent trough

Polypropylene, natural  
50 troughs  
Part no. 10619686



### 125 ml disposable reagent trough

Polypropylene, natural  
50 troughs  
Part no. 10619196



### 300 ml SBS disposable reagent trough, flat bottom

Polypropylene, natural  
40 troughs  
Part no. 30077312



### 300 ml SBS disposable reagent trough, convoluted bottom

Polypropylene, natural  
40 troughs  
Part no. 30077313

# AC Extraction Plate.





## AC Extraction Plate – LC-MS sample preparation made easy



Tecan's AC Extraction Plate with TICE™ (Tecan Immobilized Coating Extraction) technology revolutionizes your sample preparation routine. A simple pipette and shake sequence is all that is required, with no filtration, centrifugation or solvent evaporation steps. The AC Extraction Plate is easily integrated into automated processes, making it a perfect match for Tecan's Freedom EVO and Fluent liquid handling platforms.

Part number: 30072211  
(1 plate per unit)

Number of tests: 96

Maximum volume: 500 µl

### Simplified 'pipette and shake' workflow for automated LC-MS sample preparation using the AC Extraction Plate:

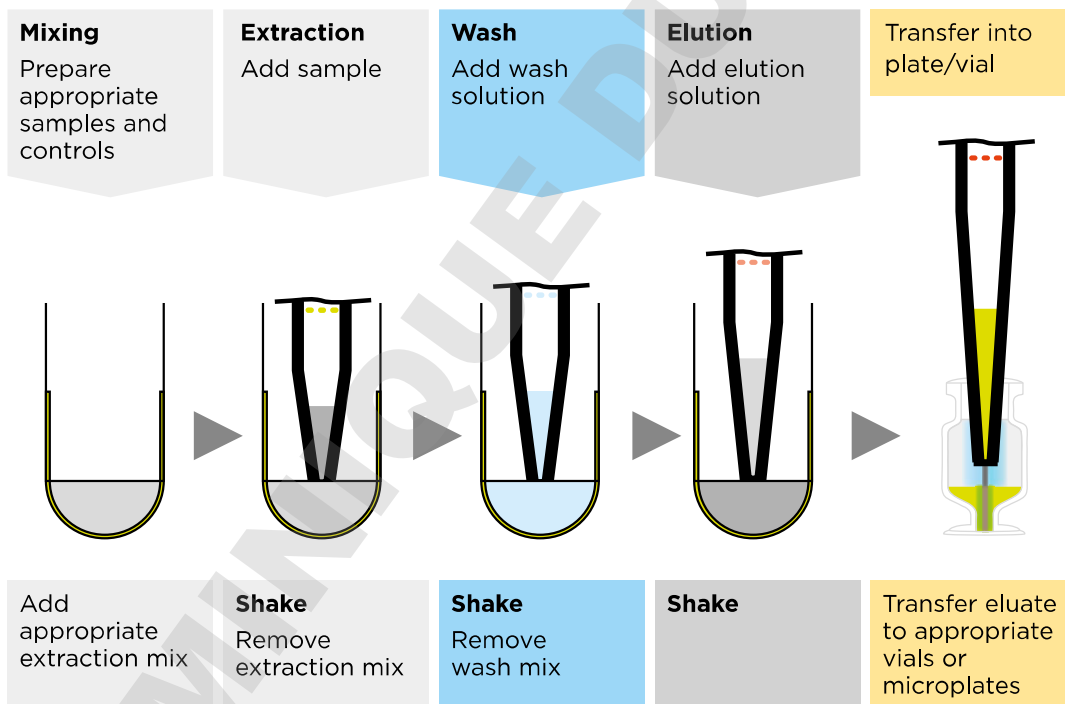

# QC Kit.





## Quality assurance with the QC Kit

The need for ever stricter quality control requires laboratories to perform regular quality checks on their assays and equipment, including their automated liquid handling workstations. Tecan has addressed this need by introducing the QC Kit, allowing quick and comprehensive volume transfer verification for Freedom EVO and Fluent workstations.

### QC Kit verification plates



Part number	Description	Content	Additional information
30062826	QC Kit verification Plates, 96-well	25 plates	Plates with characterized well dimensions
30062827	QC Kit verification Plates, 384-well	25 plates	Plates with characterized well dimensions

### QC Kit baseline and diluent solutions



Part number	Description	Content	Additional information
30062828	QC Kit baseline solution	220 ml	Required prior to verification testing
30062829	QC Kit diluent dye solution	500 ml	Required for verification testing with the range solution

### QC Kit sample solutions



Part number	Description	Content	96-well volume range	384-well volume range
30062840	QC Kit sample dye range A solution	500 ml	50-200 $\mu$ l	10-55 $\mu$ l
30062841	QC Kit sample dye range B solution	110 ml	10-49.99 $\mu$ l	2.5-9.99 $\mu$ l
30062842	QC Kit sample dye range C solution	110 ml	2.0-9.99 $\mu$ l	0.50-2.499 $\mu$ l
30062843	QC Kit sample dye range D solution	110 ml	1.0-1.99 $\mu$ l	0.30-0.499 $\mu$ l
30062844	QC Kit sample dye range E solution	110 ml	0.1-0.99 $\mu$ l	0.03-0.299 $\mu$ l

## How to order consumables

Visit our website at [www.tecan.com/consumables](http://www.tecan.com/consumables) to discover our full portfolio and order online. A webshop is currently also available in the United States. For other countries, please request a quote via our consumables configurator.

You can also contact your local Tecan sales office by phone, e-mail or fax:

Tecan sales organizations			
Australia	T +61 3 9647 4100	F +61 3 9647 4199	info-aus@tecan.com
Austria	T +43 6246 8933 0	F +43 6246 72770	info-de@tecan.com
Benelux	T +32 15 42 13 19	F +32 15 42 16 12	tecan-be@tecan.com
China	T +86 21 22063206	F +86 21 2206 5260	Helpdesk-CN@tecan.com
France	T +33 4 72 76 04 80	F +33 4 72 76 04 99	tecan.france@tecan.com
Germany	T +49 79 51 94 170	F +49 79 51 50 38	info-de@tecan.com
Italy	T +39 2 92 44 790	F +39 2 92 72 90 47	tecan-it@tecan.com
Japan	T +81 044 556 7338	F +81 44 556 7312	helpdesk-jp@tecan.com
Nordic	T +46 8 750 39 40	F +46 8 750 39 56	info@tecan.se
Spain	T +34 93 595 25 31	F +34 93 330 87 00	tecan.spain@tecan.com
Switzerland	T +41 44 922 89 22	F +41 44 922 89 23	tecan.sales.ch@tecan.com
UK	T +44 118 930 0300	F +44 118 930 5671	tecanuk@tecan.com
USA	T +1 800 832 2687	F +1 919 361 3601	order.entry@tecan.com

For distributor contacts visit [www.tecan.com/tecan-distributors-worldwide](http://www.tecan.com/tecan-distributors-worldwide)

### Tecan – Who we are

Tecan ([www.tecan.com](http://www.tecan.com)) is a leading global provider of laboratory instruments and solutions in biopharmaceuticals, forensics and clinical diagnostics. The company specializes in the development, production and distribution of automated workflow solutions for laboratories in the life sciences sector. Its clients include pharmaceutical and biotechnology companies, university research departments, forensic and diagnostic laboratories. As an original equipment manufacturer (OEM), Tecan is also a leader in developing and manufacturing OEM instruments and components that are then distributed by partner companies.

Founded in Switzerland in 1980, the company has manufacturing, research and development sites in both Europe and North America and maintains a sales and service network in 52 countries.

**Australia** +61 3 9647 4100 **Austria** +43 62 46 89 330 **Belgium** +32 15 42 13 19 **China** +86 21 220 63 206 **France** +33 4 72 76 04 80 **Germany** +49 79 51 94 170  
**Italy** +39 02 92 44 790 **Japan** +81 44 556 73 11 **Netherlands** +31 18 34 48 17 4 **Nordic** +46 8 750 39 40 **Singapore** +65 644 41 886 **Spain** +34 93 595 25 31  
**Switzerland** +41 44 922 89 22 **UK** +44 118 9300 300 **USA** +1 919 361 5200 **Other countries** +41 44 922 81 11

Tecan Group Ltd. makes every effort to include accurate and up-to-date information within this publication; however, it is possible that omissions or errors might have occurred. Tecan Group Ltd. cannot, therefore, make any representations or warranties, expressed or implied, as to the accuracy or completeness of the information provided in this publication. Changes in this publication can be made at any time without notice. All mentioned trademarks are protected by law. For technical details and detailed procedures of the specifications provided in this document please contact your Tecan representative. This brochure may contain reference to applications and products which are not available in all markets. Please check with your local sales representative. All mentioned trademarks are protected by law. In general, the trademarks and designs referenced herein are trademarks, or registered trademarks, of Tecan Group Ltd., Männedorf, Switzerland. A complete list may be found at [www.tecan.com/trademarks](http://www.tecan.com/trademarks). Product names and company names that are not contained in the list but are noted herein may be the trademarks of their respective owners.

© 2018, Tecan Trading AG, Switzerland, all rights reserved. For disclaimer and trademarks please visit [www.tecan.com](http://www.tecan.com)

[www.tecan.com](http://www.tecan.com)

