



Life Science Catalog

Products, user tips, and practical knowledge
for life science applications.

BRAND. For lab. For life.®

DOMINIQUE RUSCHER SAS

DOMINIQUE DUTSCHER SAS

Simple, easy, and efficient

Your life science applications with products from BRAND

At BRAND you will find the right consumables and liquid handling instruments for PCR, microbiology, cell culture and many other life science applications.

Each of our products emphasizes simple and easy lab work and an efficient workflow for your experiments. In this catalog, for example, find out how you can minimize evaporation losses during PCR (page 105) or achieve efficient cell growth using our cell culture inserts (page 74).

Efficient work also involves training and information. For every product, you will find tips and advice acquired from practical experience. Additional application notes and technical information are available in our knowledge database at www.brand.de.

BRAND. For lab. For life.®

Quality “Made in Germany” from BRAND



Cleanroom quality

BRAND disposables for the field of life sciences are manufactured under controlled conditions in Germany, in one of the world's largest cleanrooms for laboratory disposables (ISO 14 644-1 Class 5, 7 and 8). Continuous cleanroom monitoring, accompanied by precise regulation of the ambient conditions, results in high temperature stability throughout the entire production area. In combination with batch-related monitoring of the raw materials and end products, this stability guarantees the consistently high quality of BRAND life science products.

Quality of raw materials

Sensitive applications, such as enzyme tests, PCR or the purification of nucleic acids and proteins, require the use of plastic disposables of the highest quality. For the production of pipette tips and PCR products BRAND uses specially selected PP types that are free of the additives di(2-hydroxyethyl) methyl-dodecyl-ammonium (DiHEMDA) and 9-octadecenamamide (oleamide). These two additives, which are often found in PP granulates, can interfere with biological tests and lead to false results. When source materials are selected for life science products, BRAND ensures any substances that could leach out of the raw material and influence the biological tests are reduced to the minimum necessary for processing. Mold release agents, such as stearate and erucic acid amide, are not used in the production process.

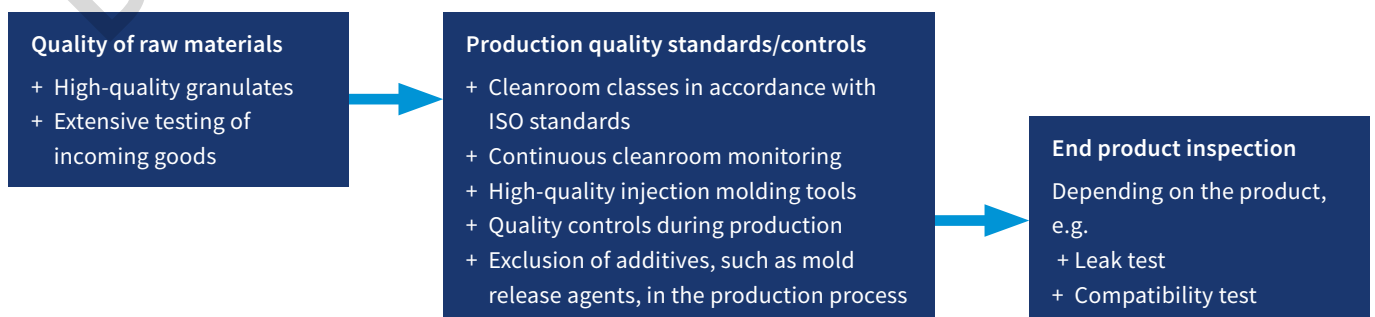



Quality levels for Life Science-Consumables

Life Science-Consumables from BRAND meet the highest quality standards and offer quality levels dedicated to the application. All products with the quality level CERTIFIED LIFE SCIENCE QUALITY and the BIO-CERT® quality labels are made of high-quality, virgin raw materials and are continuously tested for quality and function.

In addition to the general BIO-CERT® CERTIFIED QUALITY label, special quality levels for PCR, cell culture and liquid handling are available. This means you can quickly and easily find the optimal BIO-CERT® products for your application.



BIO-CERT®

	 CERTIFIED LIFE SCIENCE QUALITY	 BIO-CERT® CERTIFIED QUALITY	 BIO-CERT® CELL CULTURE QUALITY	 BIO-CERT® PCR QUALITY	 BIO-CERT® LIQUID HANDLING QUALITY
Virgin raw materials	✓	✓	✓	✓	✓
Manufactured under controlled room conditions	✓	✓	✓	✓	✓
Intensive in-process controls	✓	✓	✓	✓	✓
Visual inspections	✓	✓	✓	✓	✓
Batch management	✓	✓	✓	✓	✓
Final product inspection	✓	✓	✓	✓	✓
Proven functionality	✓	✓	✓	✓	✓
Free of human DNA		✓	✓	✓	✓
Free of RNase		✓	✓	✓	✓
Free of DNase		✓	✓	✓	✓
Free of Pyrogens		✓	✓	✓	✓
Non cytotoxic			✓		
Free of PCR-Inhibitors				✓	✓
Free of ATP					✓

Contents

Chapter I

CELL CULTURE & MICROBIOLOGY

1	Cell culture	10 - 85
1.1	Counting chambers	11
1.2	Centrifuge tubes with screw cap	17
1.3	Media bottle	20
1.4	Cryogenic tubes	22
2	Microbiology	27 - 38
2.1	seripettor® bottle-top dispenser	28
2.2	Culture and sample tubes	30
2.3	Erlenmeyer flasks	32
2.4	Centrifuge tubes	34
2.5	Petri dishes	36
2.6	Inoculation loops	36
	3 Sample analysis	39 - 46
3.1	Cuvettes	40
3.2	Microscope slides Cover glasses	44
3.3	Slide boxes	45
3.4	Staining troughs	46
	4 Assay plates	47 - 85
4.1	Non-treated plates	48
4.2	Microplates for immunoassays	54
4.3	Microplates for cell culture	60
4.4	Cell culture inserts	72

Chapter II

PCR & qPCR

5	Sample preparation	88 - 92
5.1.	PCR-suitable microtubes	89
6	PCR tubes for small and medium sample throughput	93 - 100
6.1	Single PCR tubes	94
6.2.	PCR strips	97
7	PCR plates for medium and high sample throughput	101 - 111
7.1	24-well PCR plates 48-well PCR plates	102
7.2	96-well PCR plates	104
7.3	Rigid Frame 96-well PCR plates	109
7.4	384-well PCR plates	112
7.5	Rigid frame 384-well PCR plates	114
8	Sealing options	117 - 125
8.1	PCR cap strips	118
8.2	Sealing films	121

Chapter III

SAMPLE STORAGE

9	Sample storage down to -80 °C	130 - 148
9.1	Microtubes with snap lid	131
9.2	Microtubes with lid closure	134
9.3	Microtubes with screw cap and plug seal	137
9.4	Microplates, PP Deep-well plates, PS	140
9.5	Deep-well plates, PP	143
9.6	Tube racks	147
10	Sample storage down to -196 °C	149 - 157
10.1	Microtubes with screw cap and silicone seal	150
10.2	Cryogenic tubes	156

Simple, easy, and efficient work – some examples:



Proliferation of CHO cells on BRANDplates® cellGrade™ surface

Page 64



Unlimited flexibility with BRAND Insert 2in1 cell culture inserts

Page 78



Greater sensitivity during qPCR reactions with BRAND 384-well PCR plates

Page 112



Microtubes with secure lid closure

Page 134



CELL CULTURE &



MICROBIOLOGY

Identifying unknown pathogens and understanding cell signaling pathways (e.g. tumor biology or neurodegenerative diseases) are ongoing sources of scientific challenges for researchers. More and more, interdisciplinary research is being used to search for previously undiscovered active ingredients and innovative potential therapies through combining cellular and microbiological methods.

The only way to achieve the clear results essential to this research is by using the highest-quality consumable materials possible. To offer the best possible quality and purity for challenging analyses, BRAND continues to refine its Life Science products for cell culture and microbiology while optimizing manufacturing processes.



Chapter I

Cell culture & microbiology work areas

Cell banking and cryo storage

Cell cultivation | microbiology

Assaying



1.1 Counting chambers
page 11



1.2 Centrifuge tubes with
screw cap page 17



2.1 seripettor®
page 28



2.2 Culture and sample
tubes page 30



3.1 Cuvettes
page 40



3.2 Microscope slides and
cover glasses page 44



1.3 Media bottle
page 20



1.4 Cryogenic tubes
page 22



2.3 Erlenmeyer flasks
page 32



2.4 Centrifuge tubes
page 34



3.3 Slide boxes
page 45



3.4 Staining troughs
page 46



2.5 Petri dishes
page 36



2.6 Inoculation loop
page 36



4. Assay plates
page 47

Liquid Handling 10 µl - 50 ml

Liquid Handling 1 µl - 25 ml

Liquid Handling 1 µl - 50 ml



1. Cell culture

Analyzing cell cultures (from cell lines or primary cells) can provide information on the effects of active ingredients, help interpret physiological conditions, and help explain pathophysiological changes.

Monitoring cell numbers using a hemocytometer (counting chamber) is an essential preparatory step for any cell culture. Only by determining these initial values researchers can calculate generation times or check cell densities before seeding them in culture vessels or put them for cryopreservation.

To support a wide range of experimental conditions, assay plates and culture vessels need to meet a variety of cellular requirements. Because of this, BRAND offers a broad range of certified cell culture products for many different applications in the areas of pharmacology, toxicology and tissue engineering including cell counting, cryopreservation, and cell cultivation and analysis in multiwell and microtiter plates.



1.1 Counting chambers



- ✓ BLAUBRAND® quality
- ✓ Outstanding measurement precision
- ✓ 100% certified quality

Determining cell counts is a key foundation for monitoring cellular proliferation. From microbiology to cell cultures, precision measuring equipment like BLAUBRAND® counting chambers ensure precise cell counts.

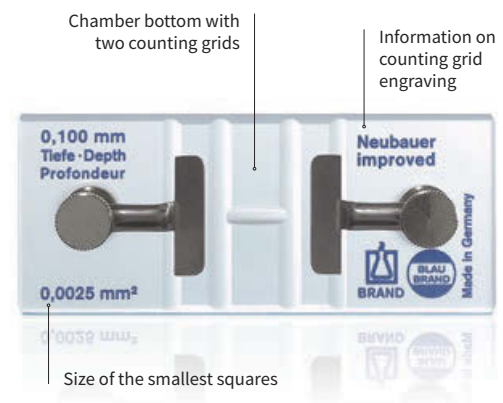

Applications

- + Quantifying bacteria and fungal spores
- + Counting plant pollen
- + Determining cell counts of cultivated cell lines and primary cells
- + Quantifying immobilized sperm

Features

- + Specialized optical glass
- + Certified BLAUBRAND® quality
- + In accordance with DIN 12 847
- + Available with and without spring clips
- + Includes 2 hemocytometer cover glasses
- + 2 counting grids per chamber for counts



User information

Object counting with BLAUBRAND® counting chambers

- The aperture on the microscope condenser must be nearly closed.
- For counts in the 4 large squares at the corners, the use of a 10x objective (100x zoom) is recommended.
- A 40x objective is a better choice for counts in the central large square (such as for erythrocytes, algae cells and yeast).
- Double counts should be completed for all cell counts, especially if a sample includes a small number of cells.
- Allow the cells sufficient time to settle before starting a cell count.
- The more fields that are counted, the more accurate the count will be.
- The difference between the total counts for both counting grids may not exceed ten cells. The average for the counts is then used in the calculation formula.

Single line

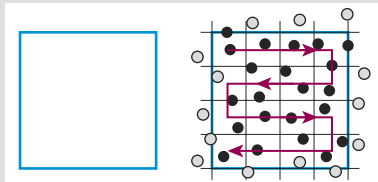

Outer line

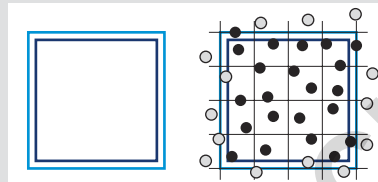

Middle line

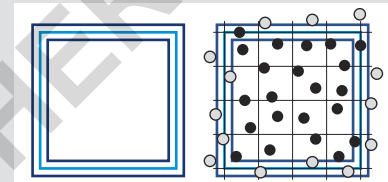

The arrow indicates the process for counting, for instance from top to bottom. The light blue line in all three of the group squares shown above represents the boundary line, while the dark blue lines are guide lines.

Cells touching the boundary lines of the counting square on two adjacent sides are also included in the count. The drawing shows this for the top and right boundary lines. Cells to be included in the count are represented as solid black circles. Cells that touch the bottom and left boundary lines, in contrast, are not included in the count. These cells are represented as white circles with black outline.

Equation for particle determination (for general use)

$$\text{Particles per } \mu\text{l volume} = \frac{\text{Counted particles}}{\text{Counted surface (mm}^2\text{)} \cdot \text{Chamber depth (mm)} \cdot \text{Dilution}}$$

Example: Erythrocytes

Chamber: Improved Neubauer

1. Counted particles: 528 erythrocytes
2. Counted surface: 5 group squares, equivalent to 0.2 mm²
3. Chamber depth: 0.1 mm
4. Dilution: 1:200

Calculation

$$\frac{528 \cdot 200}{0.2 \cdot 0.1 \cdot 1} = 5.28 \cdot 10^6 \text{ Ery}/\mu\text{l blood}$$

Models

Counting chamber
with spring clips



Counting chamber
without spring clips





Technical information & Ordering data

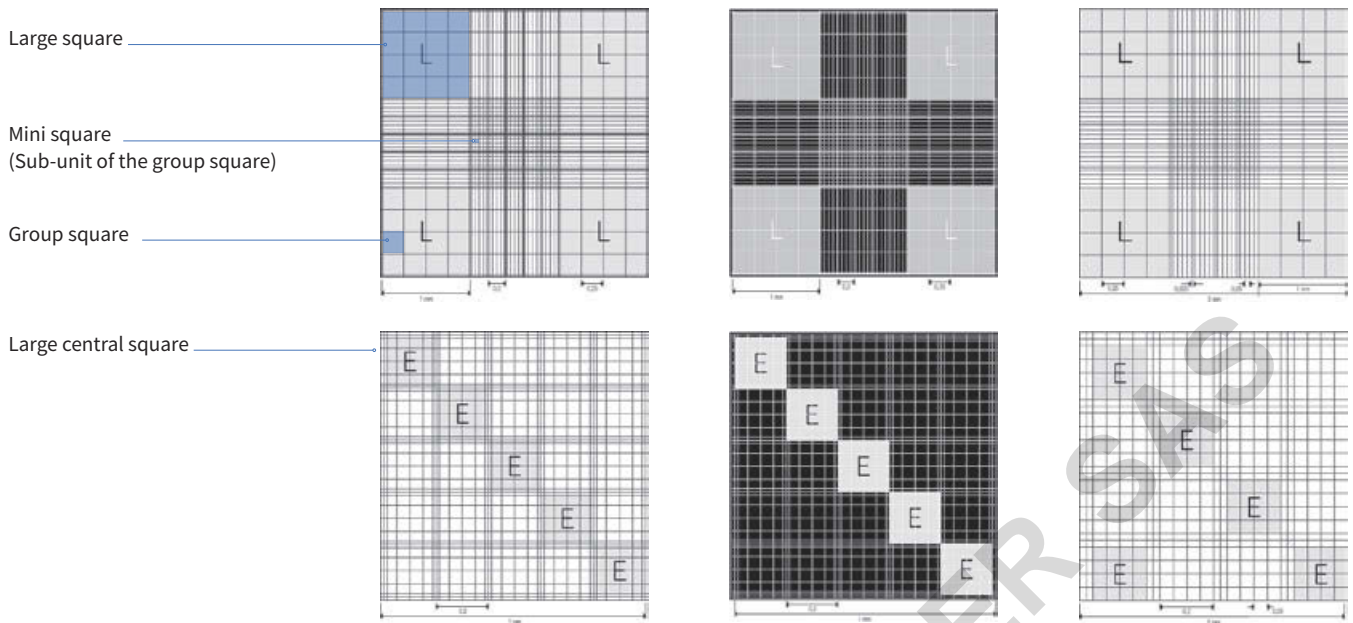

Ruling	Neubauer improved	Neubauer improved bright-line	Neubauer
Large squares "L"	area of 1 mm ² each with 16 group squares of 0.0625 mm ² each	area of 1 mm ² each with 16 group squares of 0.0625 mm ² each	area of 1 mm ² each with 16 group squares of 0.0625 mm ² each
Large central square	area of 1 mm ² each with 25 group squares of 0.04 mm ² each area mini square: 0.0025 mm ²	area of 1 mm ² each with 25 group squares of 0.04 mm ² each area mini square: 0.0025 mm ²	area of 1 mm ² each with 16 group squares of 0.04 mm ² each area mini square: 0.0025 mm ²
Chamber depth	0.1 mm	0.1 mm	0.1 mm
Special feature	all group squares have triple boundary lines on each side	all group squares have triple boundary lines on each side; rhodium-coated chamber bottom for reversed microscopy (dark field)	-
For quantification of	Leucocytes "L" counter square other cell types Erythrocytes "E" large central square Thrombocytes square yeast bacteria	Leucocytes "L" counter square other cell types Erythrocytes "E" large central square Thrombocytes square yeast bacteria	Leucocytes "L" counter square other cell types Erythrocytes "E" large central square Thrombocytes square yeast bacteria
	without spring clips	without spring clips	without spring clips
	with spring clips		with spring clips
Cat. No.	717805	717820	717810
			718605
			718620



Hemocytometer cover glasses for Neubauer improved and Neubauer counting chambers

L x W	20 x 26 mm
Thickness [mm]	0.4
Flatness tolerance [µm]	± 3
Pack of	100 pieces (10 boxes at 10 cover glasses)
Cat. No.	723015

i BLAUBRAND® counting chambers are delivered with two matching hemocytometer cover glasses. Technical specifications are listed on the following two pages.



(continued counting chambers)

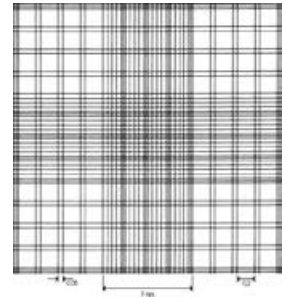
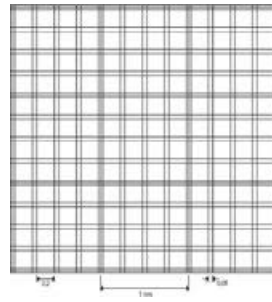
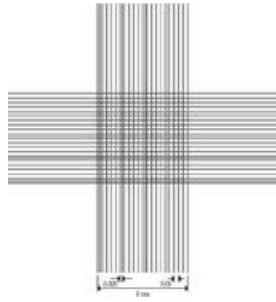

Large central square

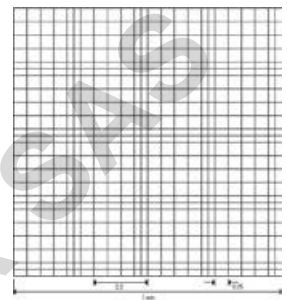
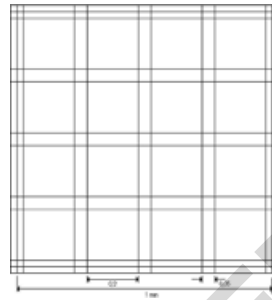
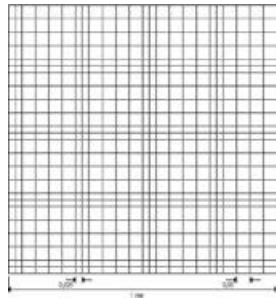

Ruling	Thoma	Bürker	Bürker-Türk			
Large squares	not present	area of 1 mm ² each with double line divided into 16 group squares of 0.04 mm ² each	area of 1 mm ² each with double line divided into 16 group squares of 0.04 mm ² each			
Large central square	area: 1 mm ² with 16 group squares of 0.04 mm ² area mini square: 0.0025 mm ²	no further division	area: 1 mm ² with 16 group squares of 0.04 mm ² area mini square: 0.0025 mm ²			
Chamber depth	0.1 mm	0.1 mm	0.1 mm			
Special feature	-	double lines create mini squares of 0.0025 mm ² each in all large squares	combination of the Bürker and Thoma systems			
For quantification of	Erythrocytes Thrombocytes other cell types	Erythrocytes Thrombocytes other cell types	Erythrocytes Thrombocytes other cell types			
	without spring clips	with spring clips	without spring clips	with spring clips		
Cat. No.	718005	718020	718905	718920	719505	719520



Hemocytometer cover glasses for Thoma, Bürker and Bürker-Türk counting chambers

L x W	20 x 26 mm
Thickness [mm]	0.4
Flatness tolerance [µm]	± 3
Pack of	100 pieces (10 boxes at 10 cover glasses)
Cat. No.	723015

Pure white (clear) borosilicate glass, hydrolytic class 1, DIN ISO 8255. Refractive index $n_e = 1.52 \pm 0.01$; Abbe number $v_e = 56.5 \pm 0.5$. Hemocytometer cover glasses differ from ordinary cover glasses by their plain ground and polished surface.





(continued counting chambers)

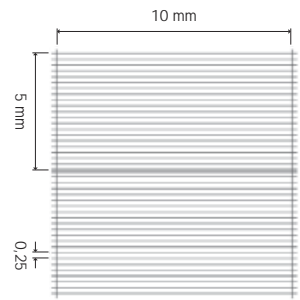
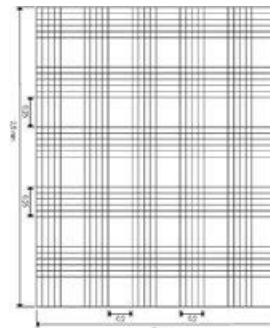
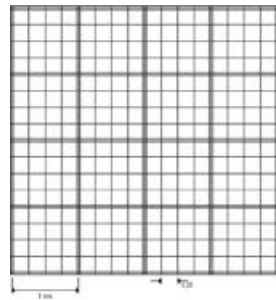

Large central square

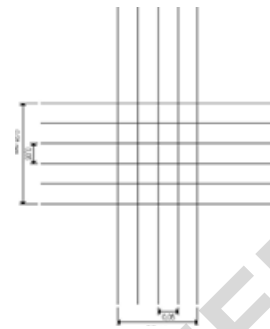
**Ruling**

Large squares

Large central square

Chamber depth

Special feature

For quantification of

Fuchs-Rosenthal

area of 1 mm² each
with 16 group squares of
0.0625 mm² each

no further division

0.2 mm

counting grid size 4 mm x 4 mm
total area 16 mm²

cells in the cerebrospinal fluid

Malassez

area per rectangle: 0.05 mm²
with 20 mini squares of
0.0025 mm² per large square

no further division

0.2 mm

rectangular ruling
2.5 mm x 2 mm

cells in the cerebrospinal fluid
nematodes

Nageotte

square base area: 100 mm²
divided into 40 rectangles with
2.5 mm²

no further division

0.5 mm

large chamber volume facilitates
robust quantification of leuco-
cyte concentrations, even below
10 / μl

cells in the cerebrospinal fluid
remaining leucocyte quantities
in apheresis concentrates
nematodes

without
spring clipswith spring
clips

without spring clips

without spring clips

Cat. No.

719805

719820

719005

721305

**Hemocytometer cover glasses for
Fuchs-Rosenthal, Malassez and
Nageotte counting chambers**

L x W

24 x 24 mm

20 x 26 mm

22 x 30 mm

Thickness [mm]

0.4

0.4

0.4

Flatness tolerance [μm]

± 3

± 3

± 3

Pack of

100 pieces
(10 boxes at 10 cover glasses)

100 pieces
(10 boxes at 10 cover glasses)

100 pieces
(10 boxes at 10 cover glasses)

Cat. No.

723014

723015

723016



Cleaning

We recommend using the disinfectant **gigasept® instru AF** to clean counting chambers. Please observe proper validated cleaning procedures for your specific counting chamber.

100 g solution contains the following active substances: 15.6 g Cocosporylene diamineguanidine diacetate, 35 g Phenoxypropanols, 2.5 g Benzalkoniumchloride.

gigasept® instru AF

Concentrate, Desinfektionsreiniger

Suitable for manual disinfecting and cleaning of thermostable and thermolabile instruments of all types (excluding flexible endoscopes).

Description	Pack of	Cat. No.
2 liter bottle	5	44790
5 liter can	1	44793



Chemical-physical data

Viscosity, dynamic:
approx. 30 mPa*s / 20 °C / Method: DIN 54453

Flash point:
40,5 °C / Method: ISO 3679

Form: liquid

Density: ca. 0,99 g/cm³ / 20 °C

Color: green

pH: 9,1 - 9,5 / 100 % / 20 °C

Accessories for automated cell counters

Sample cup for Technicon-Analyzer

PS, transparent.
Packed in bags of 1000.



Capacity [ml]	Upper Ø [mm]	Lower Ø [mm]	Height [mm]	Cat. No.
1.5	15	12.2	22.7	115015
2	14.8	12.8	24.9	115016
4	17	13.3	38	115017

Sample cup for COULTER COUNTER®

PS, transparent. PE lid.
Pack quantity: 1000 = 4 bags of 250.



Capacity [ml]	Ø [mm]	Height [mm]	Cat. No.
20	32	56	722055

Push-on caps

PE. Suitable for Technicon 1.5 ml and 2 ml sample tubes. Pack of 1000.

Cat. No. 115020





1.2 Centrifuge tubes with screw cap



- ✓ Biologically inert polypropylene for optimal cell and protein recovery
- ✓ Screw cap with plug seal offers protection against leaks
- ✓ Highly transparent PP for optimal sample visibility

Conical centrifuge tubes with screw closures are standard equipment in any cell culture laboratory. Defined dimensions ensure a good fit on commonly available centrifuge tubes. We use the purest, highest-quality materials available during manufacturing, ensuring outstanding sample integrity. Due to their excellent mechanical and chemical resistance, centrifuge tubes from BRAND are also a good choice for short-term sample and solution storage.

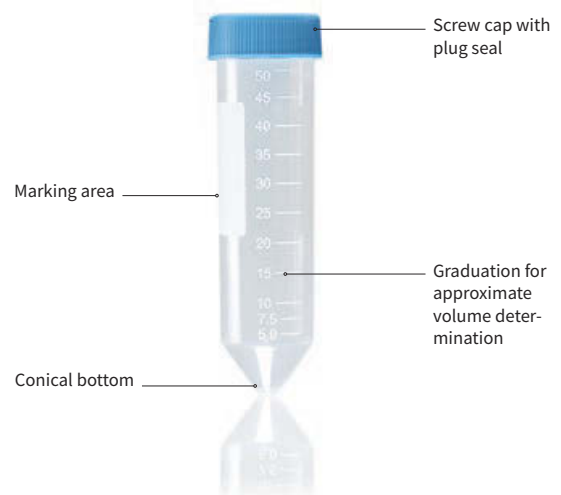

Applications

- + Adding culture medium
- + Holding cell suspension during passaging
- + Aliquoting and short-term storage of cell culture serum
- + Preparing SDS PAGE collection and separating gel solutions
- + Preparing solutions for protein biochemistry
- + For research use only!

Features

- + PP for good chemical resistance (PE cap)
- + Clear graduation
- + Sterile version available (sterility assurance level SAL 10⁻⁶)
- + Centrifuge up to 3000 x g



User information

Centrifuging information

The centrifuge tubes can withstand up to 3000 x g which meets the requirements of commonly used centrifugation protocols in cell culture.

General fractionation of whole blood into blood plasma and cellular fractions.	1500 - 3000 x g
Sedimentation of cells in liquor	1000 x g
General centrifuging during passaging of eukaryotic cells	≤ 600 x g

Frequently, the duration of centrifugation has a greater impact on cell viability than the relative centrifugal force (RCF).

Caution!

The relative centrifugal force (RCF) depends on the radius of the rotor and the speed (RPM) of the centrifuge.

General conversion formula

$$g = \text{RCF} = ((U/\text{min})/1000)^2 \cdot r \cdot 1.118$$

g-value:

Gravitational acceleration

RCF:

Relative centrifugal force
(corresponds to the g-value)

r:

Rotation radius

U/min:

Rotor rotations per minute
(speed)



Adding a laboratory film as an additional external seal on the cap reduces the danger of contamination, for example if medium aliquots are to be heated in a water bath or serum is to be heat-inactivated.

Accessories

Test tube rack



PTFE. Excellent chemical resistance. Operating temperature -200 °C to 250 °C.
Pack of 1.



for Ø up to [mm]	Positions	L x W x H [mm]	Cat. No.
13	21	180 x 60 x 60	115510
19	10	180 x 60 x 70	115515
30	4	180 x 60 x 80	115520

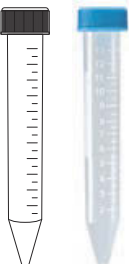

Technical information & Ordering data

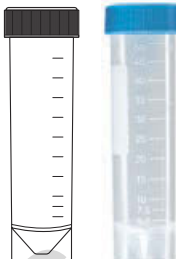
			
	Capacity 15 ml	Capacity 50 ml	Capacity 50 ml
Description	conical	conical	self-standing
Subdivision up to [ml]	13	50	50
Height [mm]	120	114	116
Outer-Ø [mm]	17	30	30
Cap	screw cap PE with plug seal	screw cap PE with plug seal	screw cap PE with plug seal
Pack of	750 pieces (5 x 150)	300 pieces (6 x 50)	250 pieces (5 x 50)
Cat. No.	114817	114820	114822

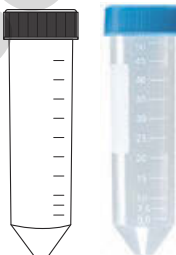
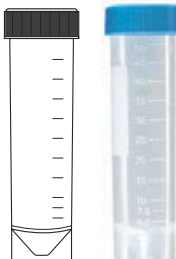
			
	Capacity 15 ml	Capacity 50 ml	Capacity 50 ml
Description	conical	conical	self-standing
Subdivision up to [ml]	13	50	50
Height [mm]	120	114	116
Outer-Ø [mm]	17	30	30
Cap	screw cap PE with plug seal	screw cap PE with plug seal	screw cap PE with plug seal
Pack of	750 pieces (5 x 150)	300 pieces (6 x 50)	250 pieces (5 x 50)
Cat. No.	114818	114821	114823



For research use only!

1.3 Media bottle



- ✓ Bottle and cap made of biologically inert material
- ✓ Larger bottle neck and bottle can be tilted by 45° for easy removal of medium
- ✓ Compatible with bottle top filters

Commonly used media bottles have narrow necks at a height that frequently require researchers to stand in uncomfortable postures over a clean bench when removing media using serological pipettes.

The new cell culture bottle from BRAND has a short profile, a wide bottle neck and can be tilted by 45°, allowing for a relaxed posture during pipetting. Thanks to its heavy weight, the cell culture bottle is always stable – either in a water bath or while using vacuum bottle top filters.



Applications

- + Preparing and storing media and buffers for cell culture
- + Adding media and buffers during sterile filtration
- + Providing medium on a clean bench

Features

- + Bottle made of Boro 3.3
- + Wide bottle neck (GL 56)
- + Suitable for autoclaving
- + Vacuum-tight
- + Clearly legible volume scale



User information

Sterile filtration of cell culture media

- Cell culture medium with added serum should not be autoclaved, since this will reduce or eliminate the biological activity of the contents.
- For sterilizing so-called complete medium, we recommend sterile filtration through a filter with a 0.2 µm pore size.

Cleaning and storage

- The biologically inert PTFE adapter can be autoclaved at 121 °C and depyrogenated at 300 °C.
- The flat sides of the media bottle allow for space-saving storage in shelves and refrigerators.

Technical information & Ordering data



Vacuum-tight media bottle for sterile filtration

Description	bottle with screw cap	screw cap	thread adapter
Thread	GL 56	GL 56	GL 56 / GL 45
Material	Boro 3.3 / PP	PP	PTFE
Pack of	1 piece	10 pieces	1 piece
Cat. No.	122710	122750	122755



Sterile vacuum filter unit

Thread	GL 45	GL 45
Material	PS, PES membrane	PS, PES membrane
Pore size [µm]	0.2	0.45
Pack of	12 pieces	12 pieces
Cat. No.	122760	122765

BVC liquid aspiration systems from VACUUBRAND



Accessories

Silicone tubing

Fits reducer fitting on the bottle top filter.



Inner-Ø [mm]	Outer-Ø [mm]	Wall thickness [mm]	Cat. No.
5	8	1.5	143358
6	9	1.5	143359
6	10	2	143360
7	10	1.5	143361
8	12	2	143362

1.4 Cryogenic tubes



- ✓ Safe long-term storage
- ✓ Perfectly sealed containers
- ✓ Highly stable

Cryopreservation is an essential process for halting almost all chemical reactions during long-term storage and for preventing sample degradation. The most commonly used approach is to store samples in the gas phase of a liquid nitrogen tank, or in freezers. BRAND offers highly stable cryogenic tubes as an ideal choice for safe, long-term storage of biological materials. The right plastic and a precise thread design help perfectly seal these containers, reducing the danger of sample contamination.



Applications

- + Storage of micro-organisms
- + Storage of primary cells
- + Storage of cell lines
- + Storage of blood and serums
- + One-handed, aseptic work
- + Sample transport

Features

- + Sterile (SAL 10^{-3})
- + Available either with a silicone seal or sealing lip
- + Temperature stability to $-196\text{ }^{\circ}\text{C}$
- + Autoclavable at $121\text{ }^{\circ}\text{C}$ (2 bar), according DIN EN 285
- + Suitable for centrifuging with up to $14,000 \times g$ (tubes without ring stands)
- + Easy to open by hand with just a $1\frac{1}{4}$ turn



User information

Handling and safety information

- Cryogenic tubes should not be filled completely, as volumes may expand during freezing. The recommended fill volume is indicated at the upper end of the graduation.
- Cryogenic tubes with silicone sealing rings should not be opened while frozen, as this may damage the silicone seal.
- For safety reasons, BRAND recommends that cryogenic tubes be stored in the gas phase in liquid nitrogen. This reduces the danger of nitrogen penetration in case of improper use.



Advantages of external thread with sealing lip and silicone seal

- Simplifies single-handed operation in comparison to cryogenic tubes with internal thread.
- Reduces the danger of contamination.

Preparing cells for freezing

- Ensuring cell authenticity. Cells to be cryopreserved should be free of contamination and have good viability.
- Prepare cryomedium specific for the cell type, then place the cryomedium and pre-marked cryogenic tubes on ice.
- Harvest the cells, centrifuge to remove the growth media, then suspend the cell pellets in a cool cryomedium.
- Transfer the cell suspension into the cryogenic tubes and start the cooling process.



Advantages of internal thread

- Space-saving compared to cryogenic tubes with external thread.
- Colored cap inserts snap in farther. Tubes can be removed from the box using the rod (fig. below).
- Uniform exterior diameter improves fit with centrifuge rotors.

Accessories

Cryogenic tube rack

Non-slip due to rubber feet. Locking cryogenic tubes with a foot rim simplifies single-handed opening. For 50 self-standing cryotubes. Pack of 4.

Cat. No. 114860



Ice bucket

Durable, rigid polyurethane foam with excellent insulation properties. Operating temperature -196 °C to +95 °C. Pack of 1.

Capacity [l] Cat. No.

4.5 156100



Storage boxes

With openings on the lid and base to prevent condensation or ice build-up. Fits into common stainless steel containers. Operating range -196 °C to +121 °C.

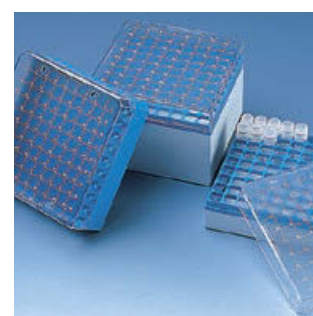

for cryogenic tubes [ml]	Positions	L x W x H [mm]	Pack of	Cat. No.
1.2 and 2	81	133 x 133 x 52	4	114862
3, 4 and 5*	81	133 x 133 x 95	5	114864
1.2 and 2**	100	133 x 133 x 52	4	114866

* external thread, ** internal thread

Tubes can be removed from the box using the rod





Technical information & Ordering data

Cryogenic tubes with external thread, sterile

- PP, graduated, outer-Ø 12.5 mm, U-bottom
- Sterility/SAL (Sterility Assurance Level) 10^{-3}
- For research purpose only!

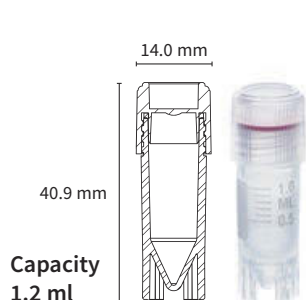

Capacity
1.2 ml

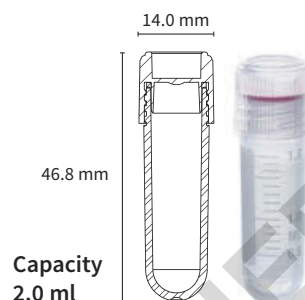

Capacity
2.0 ml

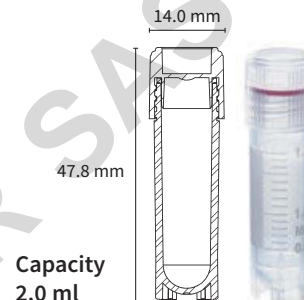

Capacity
2.0 ml

Description
Graduation up to [ml]
Height [mm]
Screw cap
Pack of
Cat. No.

self-standing
1.0
41
with silicone seal
1000 pieces (10 bags of 100)
114830

round-bottom
1.8
47
with silicone seal
1000 pieces (10 bags of 100)
114831

self-standing
1.8
48
with silicone seal
1000 pieces (10 bags of 100)
114832

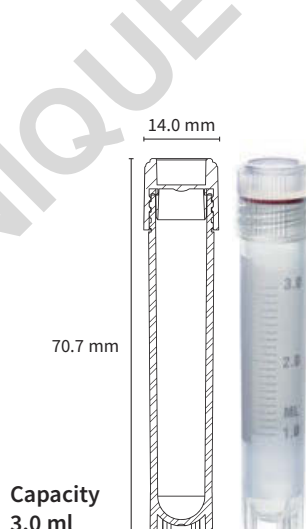

Capacity
3.0 ml

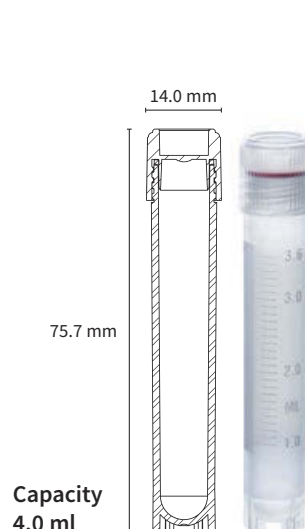

Capacity
4.0 ml

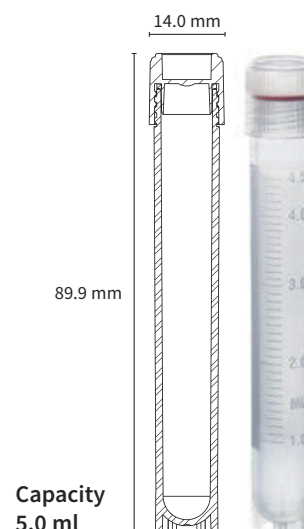

Capacity
5.0 ml

Description
Graduation up to [ml]
Height [mm]
Screw cap
Pack of
Cat. No.

self-standing
3.0
71
with silicone seal
1000 pieces (10 bags of 100)
114833

self-standing
3.6
76
with silicone seal
1000 pieces (10 bags of 100)
114834

self-standing
4.5
90
with silicone seal
1000 pieces (10 bags of 100)
114835



Cryogenic tubes with internal thread, sterile

- PP, graduated, outer-Ø 12.5 mm, U-bottom
- Sterility/SAL (Sterility Assurance Level) 10^{-3}
- For research purpose only!

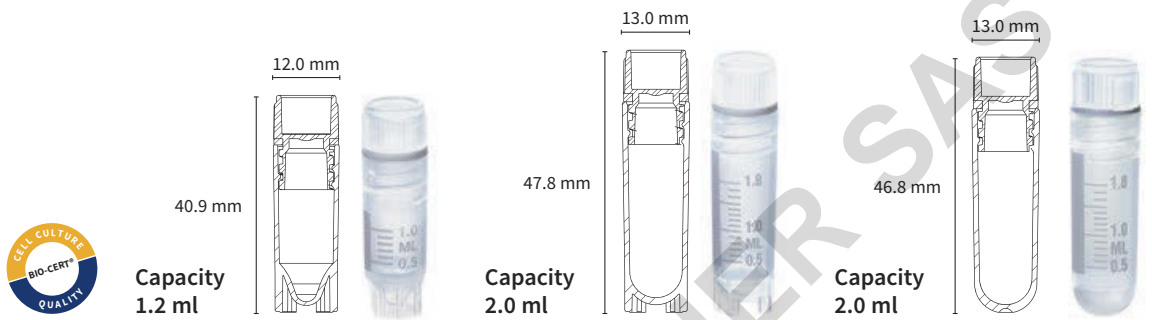

Description	self-standing	self-standing	round-bottom
Graduation up to [ml]	1.0	1.8	1.8
Height [mm]	41	48	47
Screw cap	with silicone seal	with silicone seal	with silicone seal
Pack of	1000 pieces (10 bags of 100)	1000 pieces (10 bags of 100)	1000 pieces (10 bags of 100)
Cat. No.	114840	114841	114842

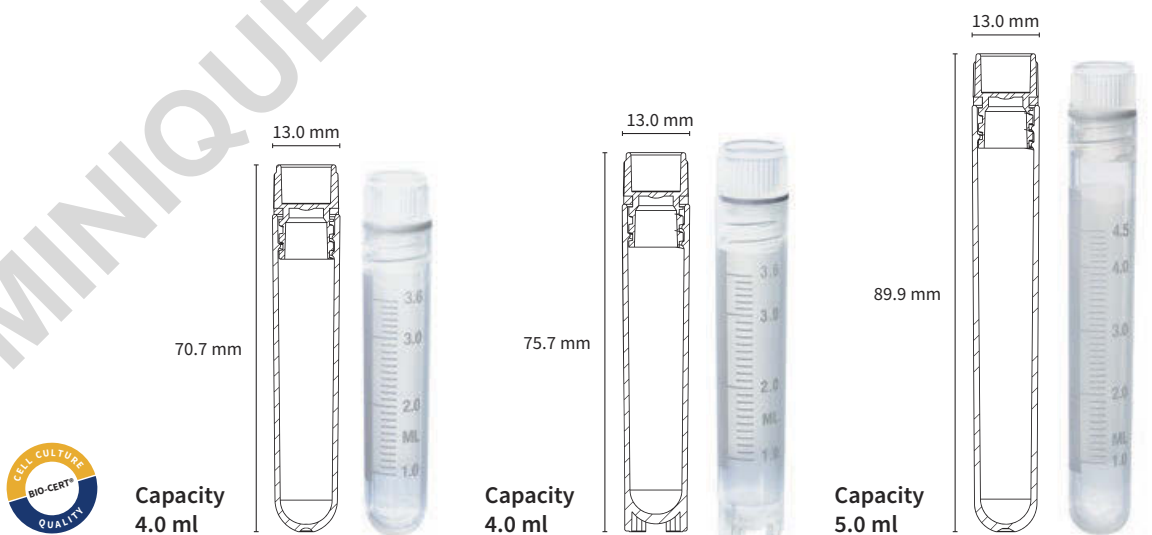

Description	round-bottom	self-standing	round-bottom
Graduation up to [ml]	3.6	3.6	4.6
Height [mm]	71	76	90
Screw cap	with silicone seal	with silicone seal	with silicone seal
Pack of	1000 pieces (10 bags of 100)	1000 pieces (10 bags of 100)	1000 pieces (10 bags of 100)
Cat. No.	114843	114844	114845



Cryogenic tubes cap inserts for color coding

PP. Fit for all sizes.



Color	white	blue	red	green	yellow
Pack of	500 pieces	500 pieces	500 pieces	500 pieces	500 pieces
Cat. No.	114850	114851	114852	114853	114854





2. Microbiology

Classic microbiological methods such as bioburden testing or creating an enrichment, mixed or pure culture are used in hygiene monitoring, product safety testing and molecular biology.

The BRAND product portfolio offers disposable plastic products and reusable glass products for liquid cultures and other cultures used in pathogen detection or during cloning and plasmid propagation.

2.1 seripettor® bottle-top dispenser



- ✓ Simple and effortless operation
- ✓ Replaceable dispensing cartridge and wearing parts
- ✓ Ideal for serial dispensing

The seripettor® bottle-top dispenser from BRAND precisely, quickly, and easily dispenses culture media into small-volume vessels with narrow necks, making difficult pipetting unnecessary. The optional flexible discharge tube with safety grip allows for a good reach and for easily placing cannulas using the culture vessel.



Applications

- + Sterile dispensing of buffers and media
- + Luer-lock air filtration system helps maintain sterility
- + Serial dispensing into culture tubes

Features

- + Easy cleaning and maintenance
- + Automatic filling, manual discharge
- + Simple operation
- + Safely handle hot aqueous solutions (up to 60 °C)
- + Can be mounted directly on bottles with a GL 45 thread
- + Sterile dispensing cartridges available



User information

Serial dispensing

The seripettor® with GL45 thread adapter fits on most standard laboratory bottles. The flexible discharge tube with grip allows for safe and easy filling of culture tubes.

The seripettor® significantly improves efficiency during serial dispensing versus working with pipettes.



Dispensing sterile liquids

1. Mount the valve block with filling tube onto the bottle and cover the valve block with cap. Attach the autoclavable sterile membrane filter (0.2 µm) to the air vent opening and autoclave at 121 °C for 15 minutes.

2. On a clean-bench or sterile hood remove the cap from the valve block, screw in a new sterile dispensing cartridge and mount the pump assembly. You're ready to dispense!

Accessories

Dispensing cartridges

Non-sterile and sterile.
Piston (PE), cylinder (PP).
Not autoclavable.



Description	Pack of	Cat. No.
2 ml	3	704500
10 ml	3	704502
25 ml	3	704504
2 ml, sterile (individually wrapped)	7	704507
10 ml, sterile (individually wrapped)	7	704506
25 ml, sterile (individually wrapped)	5	704508

Flexible discharge tube

PTFE tube, coiled, length 800 mm, with handle.
Pack of 1.



Nominal volume	Cat. No.
2 + 10 ml	704522
25 ml	704523

Cap for closing valve block

PP, autoclavable (121°C).
Pack of 1.

Description	Cat. No.
2 + 10 ml	704552
25 ml	704554



Additional accessories like pump assembly, discharge tubes and valve sets you will find at shop.brand.de



Technical information & Ordering data



seripettor®

Items supplied:

seripettor® bottle-top dispenser, for threaded bottles GL 45, discharge tube, filling tube, spare dispensing cartridge and PP adapters GL 32, GL 38 and GL S40.

Description	0.2 - 2 ml		1 - 10 ml		2.5 - 25 ml	
Subdivision [ml]	0.04		0.2		0.5	
A* ± [%] [µl]	1.2	24	1.2	120	1.2	300
CV* ≤ [%] [µl]	0.2	4	0.2	20	0.2	50
Cat. No.	4720120		4720140		4720150	

* The values of accuracy and coefficient of variation are final test values referring to the delivered volume. instrument and distilled water at equilibrium with ambient temperature (20 °C/68 °F) and smooth and steady operation. A = Accuracy. CV = Coefficient of variation

2.2 Culture and sample tubes



- ✓ Excellent sample visibility
- ✓ Tight sealing screw caps or grip stoppers
- ✓ Made of glass or plastic (PS)

Culture tubes for creating liquid and agar cultures are used in the fields of food technology, environmental analysis, infection biology or in basic research.

Culture tubes from BRAND stand out for their good resistance to centrifugal forces.



Use the seripettor® to quickly and easily transfer your culture media (or agar) into culture tubes.

With and without
screw cap

For volumes of
3 ml to 30 ml

Universal use



Applications

- + Aerobic liquid cultures
- + Anaerobic liquid cultures
- + Stab cultures
- + Agar slant cultures

Features

- + Made of soda lime glass or PS
- + With and without thread
- + PP screw caps with TPE elastomer seal
- + Glass tubes can be autoclaved (121 °C) according to DIN EN 285



Technical information & Ordering data



Culture tubes, glass with screw cap, PP

Capacity	6.5 ml	10 ml	20 ml	30 ml
Outer-Ø [mm]	12	16	16	18
Height [mm]	100	100	160	180
Wall thickness [mm]	1	1	1	1
RCF max.	3000	3000	1800	1100
Pack of	100 pieces	100 pieces	100 pieces	100 pieces
Cat. No.	113931*	113935	113941	113943



Culture tubes, glass rimless

Capacity	3 ml	5.5 ml	7.5 ml	13 ml	18 ml	22 ml	30 ml
Outer-Ø [mm]	10	12	12	16	16	16	18
Height [mm]	75	75	100	100	125	160	180
Wall thickness [mm]	0.6	0.6	0.6	0.7	0.7	0.7	0.7
RCF max.	3000	3000	3000	2600	1800	1500	900
Pack of	250 pieces	250 pieces	144 pieces	78 pieces	105 pieces	100 pieces	121 pieces
Cat. No.	114105	114106*	114110*	114115	114120	114125	114130

* Material: Fiolax®



Sample tubes, PS (disposable)

Capacity	12 ml	5 ml
Outer-Ø [mm]	16	12
Height [mm]	100	75
Wall thickness [mm]	approx. 1.1	approx. 0.9
RCF max.	2000	2000
Pack of	2000 pieces	4000 pieces
Cat. No.	114715	114760



Grip stopper	PE-LD	PE-LD
Pack of	10 000 pieces	20 000 pieces
Cat. No.	114720	114730

Racks for culture tubes and test tubes

Size 265 x 126 mm. Will not float in waterbath.

Operating temperature -20 °C to +90 °C, autoclavable.

For tubes up to Ø	13 mm	16 mm	18 mm	20 mm
Height [mm]	75	75	75	75
Positions	6 x 14	5 x 11	5 x 11	4 x 10
Pack of	5 pieces	5 pieces	5 pieces	5 pieces
Cat. No. white	4340000	4340060	4340010	4340020
Cat. No. blue	4340001	4340061	4340011	4340021
Cat. No. red	4340002	4340062	4340012	4340022

2.3 Erlenmeyer flasks



- ✓ Good mechanical resistance
- ✓ Easy to clean
- ✓ Diverse applications

Using Erlenmeyer flasks as vessels for larger liquid cultures offers the advantage of good gas exchange between the culture medium and gas phase.

BRAND Erlenmeyer flasks are made of borosilicate 3.3 glass. This makes them especially resistant to breakage, even after multiple cleaning cycles. The good mechanical resistance of BRAND Erlenmeyer flasks reduces the danger of breakage in automatic shakers.



Applications

- + Aerobic liquid cultures
- + Pure cultures
- + Enrichment cultures
- + Static cultures

Features

- + Borosilicate 3.3 glass
- + With beaded rim
- + Clearly legible divisions
- + Easy to clean



User information

Determining microbial growth in a suspension culture

Turbidity measurement has become an established, routine method for determining biomasses in a suspension culture. Turbidity correlates directly with cell count, and follows the Beer-Lambert law.

Important note:

Optical density (OD) measurement is performed at 600 nm because no pigment is present that adsorbs this wavelength.

At an $OD_{600} \leq 0.8$, the dry cell mass/ml corresponds well to the Beer-Lambert law. This means that light scatter is proportional to the number of particles released (cells).

If photometric measurements indicate an $OD_{600} \geq 0.8$, then the sample must be diluted and measured again.

Accessories



Standard cuvettes macro and semi-micro

PS and PMMA. Grouped by mold cavity number, 10 mm light path. Pack of 1000 (10 boxes of 100 cuvettes per box.)



Description	Material	Cat. No.
macro cuvette	PS	759005
semi-micro cuvette	PS	759015
macro cuvette	PMMA	759105
semi-micro cuvette	PMMA	759115

Cuvette rack

PP, gray. Numbered positions. Autoclavable (121 °C). Suitable for standard 10 mm path-length cuvettes. Pack of 1.



Description	Length [mm]	Width [mm]	Height [mm]	Cat. No.
for 16 cuvettes	210	70	38	759500



Additional cuvettes are available in the Sample analysis section, starting on p. 40

Technical information & Ordering data



Erlenmeyer flasks narrow neck

Capacity	50 ml	300 ml	500 ml	1000 ml	2000 ml
Neck outer-Ø [mm]	22	34	34	42	50
Flask outer-Ø [mm]	51	87	105	131	166
Height [mm]	90	156	180	220	280
Pack of	10 pieces	10 pieces	10 pieces	10 pieces	10 pieces
Cat. No.	92717	92739	92744	92754	92763



Erlenmeyer flasks wide neck

Capacity	50 ml	300 ml	500 ml	1000 ml	2000 ml
Neck outer-Ø [mm]	34	50	50	50	72
Flask outer-Ø [mm]	51	87	105	131	153
Height [mm]	85	156	175	220	276
Pack of	10 pieces	10 pieces	10 pieces	10 pieces	10 pieces
Cat. No.	92817	92839	92844	92854	92863



2.4 Centrifuge tubes



- ✓ Extra thick and even vessel walls
- ✓ Good chemical resistance
- ✓ Stoppers available separately

Centrifugation is essential for extracting proteins and nucleic acids from microbial liquid cultures.

Centrifuge tubes from BRAND can be used to efficiently sediment culture volumes of up to 160 ml, reducing centrifuging times. Matching stoppers perfectly seal the tubes, reducing the danger of contamination to rotors and centrifuges. After decanting supernatant, the pellet can easily be placed in interim storage at -20 °C for processing at a later time.

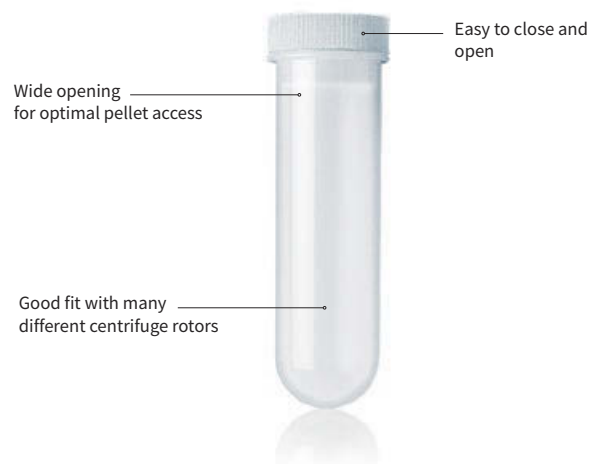

Applications

- + Centrifugation of bacterial cultures
- + Alkaline lysis of micro-organisms
- + Plasmid extraction from transformed bacteria

Features

- + High chemical resistance
- + Stoppers available separately
- + Rated up to 4500 RZBCF
- + Suitable for autoclaving (121 °C, 15 min)
- + For single use only



Technical information & Ordering data



Centrifuge tubes PP without PE-stopper

Capacity	10 ml	20 ml	26 ml	48 ml
Outer-Ø [mm]	16	20	24	30
Height [mm]	100	100	90	100
Pack of	1000 pieces (250 per bag)	500 pieces (50 per bag)	500 pieces (50 per bag)	400 pieces (25 per bag)
Cat. No.	115342	115348	115346	115350

Capacity	75 ml	110 ml	125 ml
Outer-Ø [mm]	35	40	45
Height [mm]	100	120	120
Pack of	300 pieces (20 per bag)	200 pieces (20 per bag)	100 pieces (10 per bag)
Cat. No.	115352	115354	115356

PE-stopper



For centrifuge tubes	10 ml	30 ml	26 ml	48 ml
Height tube with stopper [mm]	110	110	100	110
Pack of	1000 pieces	500 pieces	500 pieces	500 pieces
Cat. No.	115360	115366	115368	115370

For centrifuge tubes	75 ml	110 ml	160 ml
Height tube with stopper [mm]	110	130	130
Pack of	500 pieces	100 pieces	100 pieces
Cat. No.	115372	115374	115376

Racks for centrifuge tubes

Size 265 x 126 mm. Will not float in waterbath.

Operating temperature -20 °C to +90 °C, autoclavable.



For tubes up to Ø	16 mm	20 mm	25 mm	30 mm
Height [mm]	75	75	88	88
Positions	5 x 11	4 x 10	4 x 8	3 x 7
Pack of	5 pieces	5 pieces	5 pieces	5 pieces
Cat. No. white	4340010	4340020	4340030	4340040
Cat. No. blue	4340011	4340021	4340031	4340041
Cat. No. red	4340012	4340022	4340032	4340042

In general, we recommend filling at least 80% of the total volume of the centrifuge tube to prevent tube failure during centrifugation.





2.5 Petri dishes



- ✓ Temperature stability to 60 °C
- ✓ Stackable
- ✓ Crystal clear PS

Petri dishes for creating agar cultures are standard in every microbiology and molecular biology laboratory. Since the agar is poured or dosed while it is still hot, plastic petri dishes have to be able to withstand the high temperatures involved.

Petri dishes for one-time use by BRAND stand out for their excellent temperature stability, ensuring that even hot agar substances do not deform the plastic dishes.

2.6 Inoculation loops



- ✓ Sterile (SAL 10⁻⁶)
- ✓ High flexibility for agar-saving smears
- ✓ Usable at both ends

Disposable inoculation loops by BRAND reduce the danger of contamination and make cleaning and sterilization processes unnecessary.

In particular when handling pathogenic agents, disposable BRAND inoculation loops are an excellent choice for keeping infection risk low.



Use the seripettor® to quickly and easily transfer your agar into the petri dish.

Applications

Manufacturing of agar plates for

- + Pure cultures
- + Smears for separation
- + Smears for clonal colony formation after transformation (master plate)
- + Quantifying microorganisms

Features

- + Temperature stability to 60 °C
- + Fully-automated manufacturing and packaging
- + Made of highly transparent polystyrene for consistency
- + Stackable and dimensionally stable
- + With and without vents

Applications

- + For inoculating cell cultures
- + For inoculating stab cultures
- + For inoculating liquid cultures

Features

- + Made of highly flexible polystyrene
- + With loop only or with loop and needle
- + Sterile in accordance with USP 29 (SAL 10⁻⁶)
- + For single use only



Technical information & Ordering data



Petri dishes, soda-lime glass

Lid Ø	40 mm	60 mm	80 mm	100 mm	100 mm	150 mm
Base height [mm]	12	15	15	15	20	25
Pack of	10 pieces	10 pieces	10 pieces	10 pieces	10 pieces	10 pieces
Cat. No.	455701	455717	455732	455742	455743	455751



Petri dishes, PS

Lid Ø	55 mm	55 mm	94 mm	94 mm
Description	without vent	with vent	without vent	with vent
Base height [mm]	14	14	16	16
Pack of	1620 pieces	1620 pieces	480 pieces	480 pieces
Cat. No.	452015	452010	452000	452005



Inoculation loops, PS

Capacity of loop	1 µl	10 µl	1 + 10 µl
Color	natural	blue	yellow
Length [cm]	20	20	20
Pack of	1000 pieces	1000 pieces	1000 pieces
Cat. No.	452201	452210	452215



Cultivating microorganisms at an analytic scale:

96- and 384-well deep well plates are a great choice to save space and media while cultivating micro-organisms. BRAND lists products to meet your needs in chapter III on page 143.



Accessories

Threaded bottles

Soda-lime glass (amber).
Screw cap PP, pouring ring
PE-LD. Space-saving square
base.

Protects light-sensitive buffers
or media and stock solutions.

The bottles are available
ethylene-acrylate coated or
uncoated. Pack of 1.



Capacity [ml]	Width [mm]	Height [mm]	Thread	coated Cat. No.	uncoated Cat. No.
100	50	125	GL 32	704002	704012
250	65	160	GL 32	704004	704014
500	80	195	GL 32	704006	704016
1000	95	230	GL 45	704008	704018
2500*	140	300	GL 45	704010	704020

* cylindrical shape

Magnetic stirring bar retrievers

PTFE. Magnetic core fully
sealed. Pack of 1.

Length mm	Ø mm	Cat. No.
150	8	137700
250	8	137710
350	8	137720



Magnetic stirring bars

High magnetic strength and
long life due to Alnico V mag-
netic cores, fully encapsulated
with high-grade PTFE. Strict
quality control ensures the
magnetic strength, position
of the magnetic core, surface
quality, crack resistance, and
uniform thickness of the PTFE
coating. Maximum operating
temperature 270 °C.

Pack of 10.



Length [mm]	Bar Ø [mm]	cylindrical Cat. No.	ring Ø [mm]	with pivot ring Cat. No.
2	2	137100	-	-
3	3	137101	-	-
5	2	137102	-	-
6	3	137103	-	-
8	3	137104	4	137404
12	4.5	137105	6	137405
7	2	137106	-	-
8	1.5	137107	-	-
10	3	137108	-	-
13	3	137109	-	-
15	4.5	137110	6	137410
15	1.7	137111	-	-
10	6	137113	-	-
15	6	137114	-	-
20	6	137115	8	137415
25	6	137120	7	137420
30	6	137125	7.5	137425
35	6	137127	8	137527
40	8	137130	8.5	137430
45	8	137132	10	137432
50	8	137135	11	731435
60	10	137140	-	-
70	10	137145	10	137445
80	10	137150	-	-
108**	27	137155	-	-
159**	27	137160	-	-

** flattened sides, pack of 1.



To prevent demagnetization stirring bars should not be stored in a random mass but should be kept "paired".



3. Sample analysis

Routine analysis of liquids and dissolved materials is typically carried out using photometric or spectroscopic methods. Cuvettes are frequently used in both kinds of analysis. BRAND offers a variety of disposable cuvettes for the UV/VIS range, which stand out for their excellent optical transmission ranges and defined layer thicknesses. They are an inexpensive alternative to glass or quartz cuvettes in many analytic disciplines.

Staining methods used to assess biological preparations highlight whole cells or sub-cellular structures, allowing them to be identified visually. Glass slides and matching cover glasses that have the same refractive index as the lens system are an optimal choice for microscopic analysis. High-quality slides from BRAND ensure uncomplicated analysis. Staining troughs and glass slide holders facilitate easy handling and secure, space-saving archiving of preparations.



3.1 Cuvettes



- ✓ Grouped by mold cavity number
- ✓ For photometric and spectroscopic analyses
- ✓ For measurements in the UV/VIS range

In many fields, plastic disposable cuvettes for the UV/VIS range can replace expensive, sensitive glass or quartz cuvettes. Time-consuming expensive cleaning processes are eliminated, and the dangers of sample mixing and contamination are reduced to a minimum.



Information on current compatibility with different commonly available photometers is available at www.brand.de

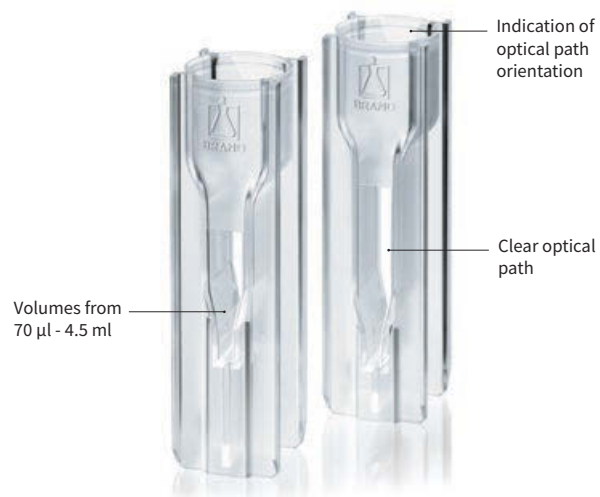

Applications

- + Extinction measurements
- + Fluorescence spectroscopy
- + Determining nucleic acid and protein concentrations

Features

- + Made of PS, PMMA and UV polymer
- + Optical pathlength 10 mm
- + Compatible with a wide variety of photometers
- + With 2 or 4 optical windows
- + For volumes between 70 µl and 4.5 ml



User information

Overview of chemical resistance and transmission properties of different cuvettes

Chemical resistance* of plastic cuvettes

Substance	PS	PMMA	UV-Cuvette
Acetic acid, 100%	-	-	+
Acetone	-	-	+
Ammonia	+	+	+
Benzaldehyde	-	-	+
Butanone	-	-	+
Chloroform	-	-	-
Dioxane	-	-	+
DMF	-	-	+
Ethyl acetate	-	-	+
Hexane	-	+	-
Hydrochloric acid, 36%	+	-	+
Hydrofluoric acid, 10%	+	+	+
Isopropanol	+	+	+
Nitric acid, 65%	-	-	+
Sodium hydroxide	+	+	+

* Short time resistance, 30 min. Longer-term storage of these chemicals should be confirmed by the user. Request a free sample.

Transmission curves of different cuvettes

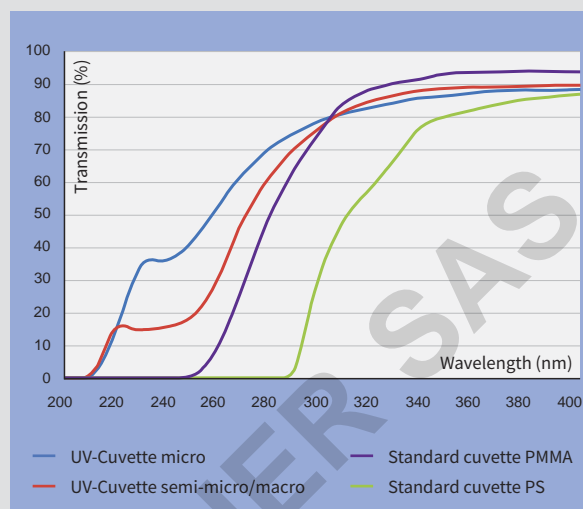

To achieve reproducible results: Before the actual measurement, always determine the blank value for the cuvette, and determine the linear range of measurement by means of a calibration curve.

Overview table

Cuvette type	Filling volume		Dimensions window (w x h)	Range of application	Standard deviation in extinction units
	min.	max.			
UV-Cuvette micro, z = 8.5	70 µl	850 µl	2 x 3.5 mm (min.)	from 230 to 900 nm	240 nm \leq ± 0.007 300 nm \leq ± 0.005
UV-Cuvette micro, z = 15	70 µl	550 µl	2 x 3.5 mm (min.)		
UV-Cuvette macro	2.5 ml	4.5 ml	10 x 35 mm		
UV-Cuvette semi-micro	1.5 ml	3.0 ml	4.5 x 23 mm		
macro cuvette (PMMA)	2.5 ml	4.5 ml	10 x 35 mm	from 300 to 900 nm	320 nm \leq ± 0.004
semi-micro cuvette (PMMA)	1.5 ml	3.0 ml	4.5 x 23 mm		
macro cuvette (PS)	2.5 ml	4.5 ml	10 x 35 mm	from 340 to 900 nm	360 nm \leq ± 0.005
semi-micro cuvette (PS)	1.5 ml	3.0 ml	4.5 x 23 mm		
macro cuvette (PS) 4 clear sided	2.5 ml	4.5 ml	10 x 35 mm	from 340 to 900 nm	360 nm \leq ± 0.005
UV-Cuvette macro 4 clear sided	2.5 ml	4.5 ml	10 x 35 mm	from 230 to 900 nm	240 nm \leq ± 0.007 300 nm \leq ± 0.005

Accessories

Cuvette rack

PP, gray. Numbered positions. Autoclavable (121 °C). Suitable for standard 10 mm path-length cuvettes. Pack of 1.



Description	Length [mm]	Width [mm]	Height [mm]	Cat. No.
for 16 cuvettes	210	70	38	759500

Disposable stirring spatula

PS. Pack quantity 10000 = 20 bags of 500 per pack.



Description	Stem Ø [mm]	Length [mm]	Cat. No.
PS	3	120	759800



Technical information & Ordering data

UV-Cuvette micro

- Usable starting from 230 nm
- Specially designed for photometric determination of proteins, ssDNA, dsDNA, RNA and oligonucleotides

Caps for UV-Cuvette micro

- Create a secure closure
- For sample storage down to -20 °C
- Multiple colors for efficient sample management

Various photometric methods are currently available for determining the concentration and purity of nucleic acids and proteins.

Protein determination using UV cuvettes:

$$C_{\text{Protein (mg/ml)}} = 1.55 \cdot A_{280 \text{ nm}} - 0.76 \cdot A_{260 \text{ nm}}$$

Nucleic determination using UV cuvettes:

$$C_{\text{DNA } (\mu\text{g/ml})} = 50 \cdot A_{260 \text{ nm}} \cdot \text{dilution factor}$$

$$C_{\text{RNA } (\mu\text{g/ml})} = 40 \cdot A_{260 \text{ nm}} \cdot \text{dilution factor}$$



UV-Cuvette micro



Center height	8.5 mm	8.5 mm	8.5 mm
Light path [mm]	10	10	10
Sample volume [μl]	70 - 850	70 - 850	70 - 850
Quality level	CERTIFIED LIFE SCIENCE QUALITY	CERTIFIED LIFE SCIENCE QUALITY	free of DNase, RNase and DNA
Pack of	100 pieces	500 pieces	100 pieces (single wrapped)
Cat. No.	759200	759210	759215



Center height	15 mm	15 mm	15 mm
Light path [mm]	10	10	10
Sample volume [μl]	70 - 550	70 - 550	70 - 550
Quality level	CERTIFIED LIFE SCIENCE QUALITY	CERTIFIED LIFE SCIENCE QUALITY	free of DNase, RNase and DNA
Pack of	100 pieces	500 pieces	100 pieces (single wrapped)
Cat. No.	759220	759230	759235



Cap for UV-Cuvettes micro



Color	blue	yellow	green	red
Material	PE	PE	PE	PE
Pack of	100 pieces	500 pieces	100 pieces	100 pieces
Cat. No.	759240	759241	759242	759243



Technical information & Ordering data

Standard cuvettes and UV-Cuvettes macro and semi-micro

- Ideally suited for determinations in water analysis, chemistry, and in life science applications
- Grouped by mold cavity number
- Significant lower costs compared to quartz glass cuvettes



Macro and semi-micro cuvettes

Description	macro		
Material	PS	PMMA	UV-Polymer
Light path [mm]	10	10	10
Sample volume [ml]	2.5 - 4.5	2.5 - 4.5	2.5 - 4.5
Pack of	1000 pieces (10 boxes of 100 cuvettes per box)		100 pieces
Cat. No.	759005	759105	759170



Description	semi-micro		
Material	PS	PMMA	UV-Polymer
Light path [mm]	10	10	10
Sample volume [ml]	1.5 - 3.0	1.5 - 3.0	1.5 - 3.0
Pack of	1000 pieces (10 boxes of 100 cuvettes per box)		100 pieces
Cat. No.	759015	759115	759150

Technical information & Ordering data

Macro cuvette 4 clear sided

- For efficient and safe work, without cleaning steps
- Suitable for fluorescence spectroscopy
- Significantly lower costs for use compared to quartz glass cuvettes
- UV-Cuvettes show minimal autofluorescence

Minimal autofluorescence of UV-cuvettes

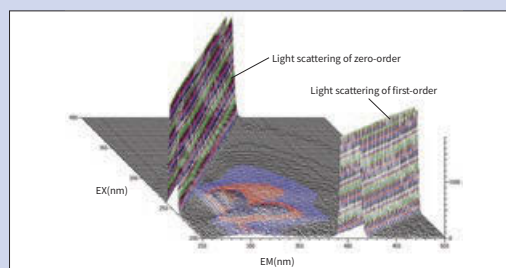

3-D scan from 200 to 400 nm wavelength with Hitachi F -7000 FL-Spectrometer



Macro cuvette 4 clear sided

Material	PS	PS	UV-Polymer	UV-Polymer
Light path [mm]	10	10	10	10
Sample volume [ml]	2.5 - 4.5	2.5 - 4.5	2.5 - 4.5	2.5 - 4.5
Pack of	100 pieces	500 pieces	100 pieces	500 pieces
Cat. No.	759030	759035	759125	759128



3.2 Microscope slides | Cover glasses disposables



Microscope slides

Microscopic slide blanks from BRAND are manufactured from highly pure soda-lime glass using a float glass process. A multi-stage cleaning process ensures a perfectly clean surface.

Applications

- + Analysis of tissue sections and cellular suspensions
- + Producing permanent and fresh preparations

Features

- + Very good wettability
- + Fits in machinery
- + No inclusions
- + Good chemical and temperature resistance
- + Available with frosted end
- + In accordance with DIN ISO 8037-1



The "ground edge" version reduces the risk of injury.

Cover glasses

Cover glasses from BRAND are manufactured of pure white borosilicate glass in hydrolytic class 1. Fully-automated processing ensures absolutely clean, dust, and grease-free quality.

Applications

- + For covering preparations on microscopic slides

Features

- + Thickness No. 1 (0.13 to 0.17 mm)
- + Refractive index 1.52 ± 0.01 ;
- + Abbe number $v_d = 56.5 \pm 0.5$
- + Distortion-free flatness within $\pm 3 \mu\text{m}$



Store dry and at a consistent temperature

Technical information & Ordering data

Microscope slides

Description	ground edges		cut edges	
Frosted end	-	both ends	-	both ends
Pack of	2500 pieces (50 boxes of 50)		2500 pieces (50 boxes of 50)	
Cat. No.	474743	474744	474701	474702

Cover glasses

Description	square shape				rectangular shape		
Size [mm]	18 x 18	20 x 20	22 x 22	24 x 24	24 x 40	24 x 50	24 x 60
Pack of	2000 pieces (10 boxes of 200)				1000 pieces (10 boxes of 100)		
Cat. No.	470045	470050	470055	470060	470816	470819	470820



3.3 Slide boxes



When creating a sample bank, both safe storage and ease of finding individual preparations are important. Because of this, BRAND offers sturdy slide boxes that provide outstanding protection for fixed samples during storage and transportation.

Applications

- + Storage of fixed cell cultures
- + Storage of fixed tissue sections
- + Transportation of fixed samples

Features

- + Less hygroscopic than cardboard slide folders
- + Optimal for refrigerated storage
- + Light-resistant closure
- + Numbered slots
- + For slides size 76 x 26 mm (DIN ISO 8037-1)

Technical information & Ordering data

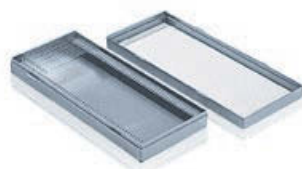

Slide boxes

Description	rectangular shape			round shape
	with index card	with index card	with index card	no
Sample identification				no
Material	PS	PS	PS	PP
Slide capacity	25	50	100	10
Size [L x W x H in mm]	120 x 96 x 35	270 x 97 x 35	230 x 187 x 35	45 (Ø) x 90 (H)
Pack of	1 piece	1 piece	1 piece	10 pieces
Cat. No.	475800	475900	476000	476900



3.4 Staining troughs



Staining troughs and inserts allow for less waste of reagents and staining solutions. Thanks to their secure fit in the inserts, multiple slides can be processed at once.

Staining troughs with inserts from BRAND offer space for multiple slides. Two practical variants allow for easy transitions between separate drainage, washing and staining solutions.

Applications

- + For histology and cytology stains
- + For preparation radiography

Features

- + Good chemical resistance
- + Inserts and staining troughs available separately
- + Easy to clean

Technical information & Ordering data



Staining troughs

Description	glass
Size [L x W x H in mm]	105 x 85 x 70
Slide capacity	10
Lid	Glass cover
Pack of	10 pieces
Cat. No.	472200

Accessories

Description	separate insert	wire handle for tray
Pack of	10 pieces	10 pieces
Cat. No.	472000	473100



4. Assay plates

Many automated high throughput processes in the Life Sciences, such as compound, high-throughput screening and high-content analyses, are reliant on the use of assay plates. Based on their compliance with ANSI/SLAS standards, almost all assay plates are suitable for commonly available plate readers and washers.

BRANDplates® microplates and multiwell plates are manufactured under advanced, ISO class 7 cleanroom conditions and packaged using a fully automated process. This ensures the highest possible purity, even for non-sterilized assay plates.

With available 24-, 96-, 384- and 1536-well formats and nine different surfaces created through specialized plasma treatments and coatings, they are the perfect choice for applications in microbiology, immunology, or cell culture. Depending on their pigmentation, they can be used for colorimetric, luminescence or fluorescence assays. Clear, multicolored alphanumeric codes ensure unique sample identification, and offer the option of delivering assay plates with customer-specified bar codes.

4.1 Non-treated microplates

- pureGrade™
- pureGrade™ S

Page 48

4.2 Microplates for Immunoassays

- immunoGrade™
- hydroGrade™
- lipoGrade™

Page 54

4.3 Microplates for cell culture

- cellGrade™
- cellGrade™ plus
- cellGrade™ premium
- inertGrade™

Page 60

4.4 Cell culture inserts

- Multiwell plates
- Individual inserts
- Insert strips
- Insert 2in1

Page 72

4.1 Non-treated plates



- ✓ Optimal surfaces for optimal results
- ✓ Reliable quality from the cleanroom
- ✓ Versatile use for assays and storage

BRANDplates® microplates pureGrade™ | pureGrade™ S

BRANDplates® pureGrade™ and pureGrade™ S microplates are manufactured from pure, newly synthesized polystyrene (PS). The raw materials used in the plates fulfill the relevant requirements of the USP and ISO 10993. Automated, ISO class 7 cleanroom production ensures the best possible cleanliness.

Grey alphanumeric codes on white and black 96-well microplates facilitate sample identification and reduce the risk of errors.

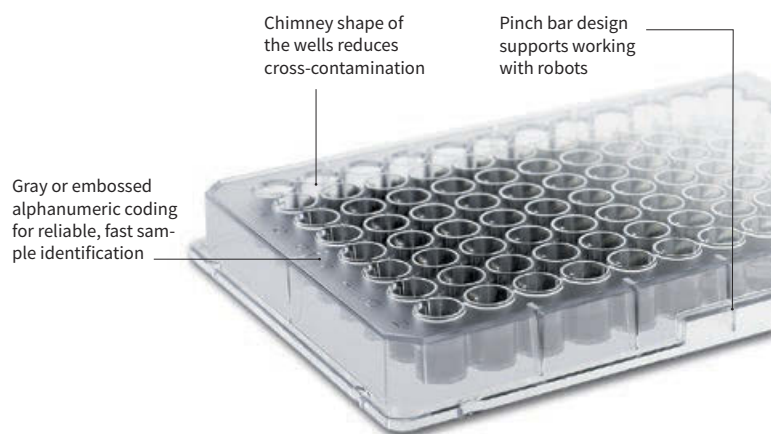

Applications

- + Dilution series
- + Homogenous assays
- + Screenings
- + Sample storage
- + DNA, RNA and protein quantification
- + Fluorescence and luminescence assays
- + Bacteriological assays

Features

- + High purity, crystal-clear polystyrene
- + Hydrophobic surface
- + For all ANSI/SLAS conforming analytic equipment
- + Medium binding surface (ELISA)
- + Available sterile and non-sterile
- + Available with barcode



User information

Transmission properties

BRANDplates® with UV-transparent film bases

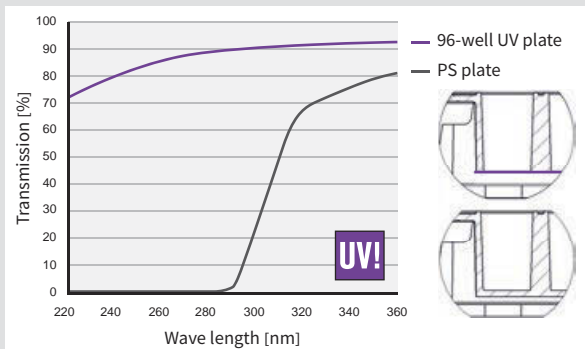

- Slightly hydrophylized for homogeneous meniscus formation
- Ideal alternative to cuvette measurement with a large number of samples
- For microplate-based nephelometry in the UV-VIS range

Technical data sheets for BRANDplates® microplates are available at www.brand.de

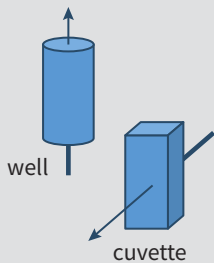

	Volume (approx.)	Light path
BRANDplates® UV-transparent	165.0 µl 322.5 µl	5 mm 10 mm
UV-cuvette micro (z = 8.5 mm)	70 - 850 µl	10 mm
UV-cuvette micro (z = 15 mm)	70 - 550 µl	10 mm

Types

pureGrade™



- Non-treated, non-sterile surface
- The standard plate for most applications
- Particularly applicable for homogenous assays, screening, and for storage.

pureGrade™ S



- Non-treated, sterile surface
- Sterilized via β -radiation according to ISO 11137 and AAMI directive
- Especially suited for bacteriological assays

Accessories



Reagent reservoirs

PP, high clarity. Capacity 60 ml.
Autoclavable (121 °C).



Description	Lid	Pack of	Cat. No.
non-sterile	with	10 pieces	703459
sterile	without	100 pieces (indiv. wrapped)	703411
sterile	without	200 pieces (40 bags of 5)	703409



Information on our single and multi-channel micro-liter pipette Transferringette® S is available at shop.brand.de

Technical information & Ordering data



96-well

Standard microplates

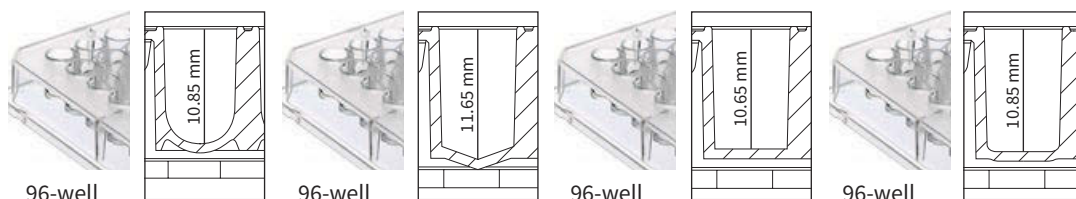

Bottom	U-bottom		V-bottom		F-bottom		C-bottom	
Color	transparent		transparent		transparent		transparent	
Well volume [μl]	330		360		350		350	
Working volume [μl]	40-300		40-330		50-320		50-330	
Bottom thickness [μm]	850		850		850		850	
Well surface [mm ²]	n/a		33		32		25	
Quality level	BIO-CERT® CERTIFIED QUALITY	BIO-CERT® CELL CULTURE QUALITY	BIO-CERT® CERTIFIED QUALITY	BIO-CERT® CELL CULTURE QUALITY	BIO-CERT® CERTIFIED QUALITY	BIO-CERT® CELL CULTURE QUALITY	BIO-CERT® CERTIFIED QUALITY	BIO-CERT® CELL CULTURE QUALITY
		sterile		sterile		sterile		sterile
Lid	-		-		-		-	
Pack of	100 pieces (20 stacks of 5 plates)	50 pieces (individually wrapped)	100 pieces (20 stacks of 5 plates)	50 pieces (individually wrapped)	100 pieces (20 stacks of 5 plates)	50 pieces (individually wrapped)	100 pieces (20 stacks of 5 plates)	50 pieces (individually wrapped)
Cat. No.	781600	781660	781601	781661	781602	781662	781603	781663



96-well

Standard microplates

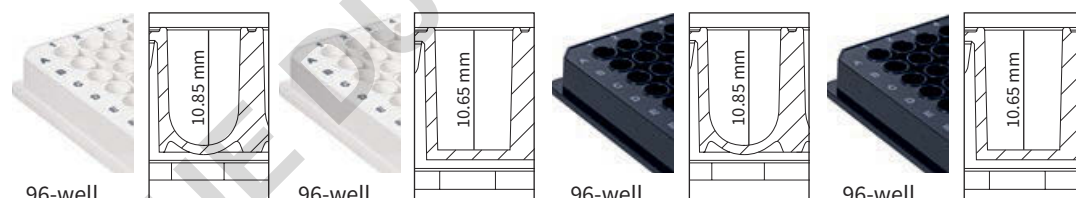

Bottom	U-bottom		F-bottom		U-bottom		F-bottom	
Color	white		white		black		black	
Well volume [μl]	330 μ		350		330		350	
Working volume [μl]	40-300		50-320		40-300		50-320	
Bottom thickness [μm]	850		850		850		850	
Well surface [mm ²]	n/a		32		n/a		32	
Quality level	BIO-CERT® CERTIFIED QUALITY		BIO-CERT® CERTIFIED QUALITY	BIO-CERT® CELL CULTURE QUALITY	BIO-CERT® CERTIFIED QUALITY		BIO-CERT® CERTIFIED QUALITY	BIO-CERT® CELL CULTURE QUALITY
				sterile				sterile
Lid	-		-		-		-	
Pack of	100 pieces (20 stacks of 5 plates)		100 pieces (20 stacks of 5 plates)	50 pieces (individually wrapped)	100 pieces (20 stacks of 5 plates)		100 pieces (20 stacks of 5 plates)	50 pieces (individually wrapped)
Cat. No.	781604		781605	781665	781607		781608	781668

Lid for 96-well standard plate, see page 84:
without condensation rings Cat. No. 782151
with condensation rings Cat. No. 782150





96-well with transparent bottom

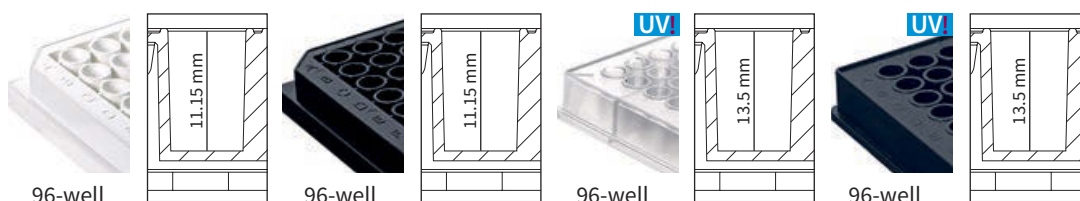

Bottom	F-bottom		F-bottom		F-bottom		F-bottom	
Color	white		black		transp., UV-transparent		black, UV-transparent	
Well volume [μ l]	330		330		410		410	
Working volume [μ l]	50-310		50-310		50-350		50-350	
Bottom thickness [μ m]	750		750		25		25	
Well surface [mm^2]	31		31		28		28	
Quality level	BIO-CERT® CERTIFIED QUALITY	BIO-CERT® CELL CULTURE QUALITY	BIO-CERT® CERTIFIED QUALITY	BIO-CERT® CELL CULTURE QUALITY	BIO-CERT® CERTIFIED QUALITY		BIO-CERT® CERTIFIED QUALITY	
Lid	sterile		sterile		-		-	
Pack of	-	50 pieces	-	50 pieces	-		-	
	100 pieces (4 bags of 25 plates)	50 pieces (individually wrapped)	100 pieces (4 bags of 25 plates)	50 pieces (individually wrapped)	50 pieces (5 bags of 10 plates)		50 pieces (5 bags of 10 plates)	
Cat. No.	781610	781670	781611	781671	781614	781615		

Lid for 96-well plates with
transparent bottom, see page 84:
Cat. No. 782155



96-well strip plates

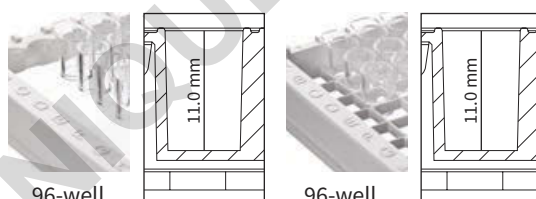

Bottom	F-bottom		F-bottom	
Color	transparent, without grid, strips of 8 wells, not divisible		transparent, with grid, strips of 8 wells, divisible	
Well volume [μ l]	360		350	
Working volume [μ l]	50-320		50-320	
Bottom thickness [mm]	1.1		1.1	
Well surface [mm^2]	37		37	
Quality level	CERTIFIED LIFE SCIENCE QUALITY		CERTIFIED LIFE SCIENCE QUALITY	
Lid	-		-	
Pack of	100 pieces (4 bags of 25 plates)		100 pieces (4 bags of 25 plates)	
Cat. No.	782300		782301	

continued pureGrade™, pureGrade™ S (sterile)



384-well

Standard microplates

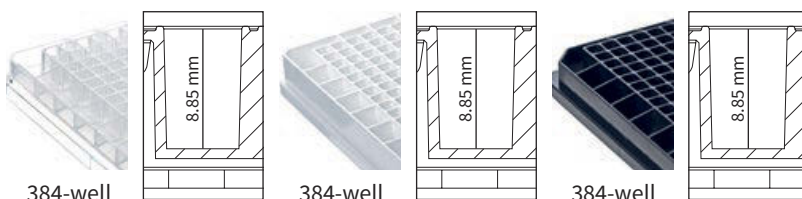

Bottom	F-bottom		F-bottom		F-bottom	
Color	transparent		white		black	
Well volume [μl]	100		100		100	
Working volume [μl]	25-80		25-80		25-80	
Bottom thickness [μm]	650		650		650	
Well surface [mm²]	12		12		12	
Quality level	BIO-CERT® CERTIFIED QUALITY	BIO-CERT® CELL CULTURE QUALITY	BIO-CERT® CERTIFIED QUALITY	BIO-CERT® CELL CULTURE QUALITY	BIO-CERT® CERTIFIED QUALITY	BIO-CERT® CELL CULTURE QUALITY
	sterile		sterile		sterile	
Lid	-		-		-	
Pack of	50 pieces (5 bags of 10 plates)	50 pieces (individually wrapped)	50 pieces (5 bags of 10 plates)	50 pieces (individually wrapped)	50 pieces (5 bags of 10 plates)	50 pieces (individually wrapped)
Cat. No.	781620	781680	781621	781681	781622	781682



384-well

with transparent bottom

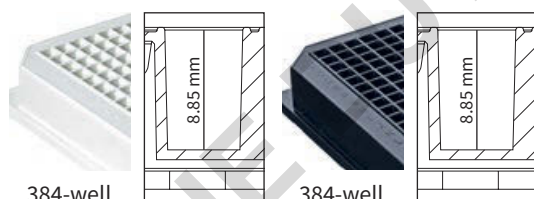

Bottom	F-bottom		F-bottom	
Color	white		black	
Well volume [μl]	120		120	
Working volume [μl]	25-100		25-100	
Bottom thickness [μm]	400		400	
Well surface [mm²]	13		13	
Quality level	BIO-CERT® CERTIFIED QUALITY	BIO-CERT® CELL CULTURE QUALITY	BIO-CERT® CERTIFIED QUALITY	BIO-CERT® CELL CULTURE QUALITY
	sterile		sterile	
Lid	-		-	
Pack of	50 pieces (2 bags of 25 pieces)	50 pieces (individually wrapped)	50 pieces (2 bags of 25 pieces)	50 pieces (individually wrapped)
Cat. No.	781626	781686	781627	781687



Lid for 384-well plates, see page 84: Cat. No. 782152



1536-well

Standard microplates

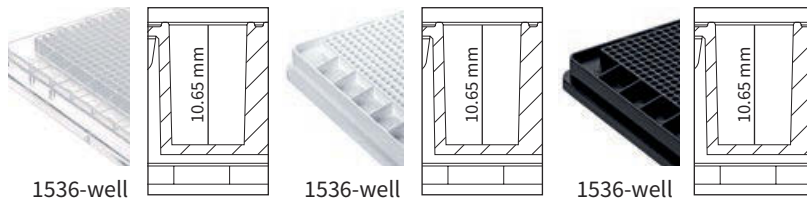

Bottom	F-bottom	F-bottom	F-bottom
Color	transparent	white	black
Well volume [μ l]	10	10	10
Working volume [μ l]	above 2	above 2	above 2
Bottom thickness [μ m]	650	650	650
Well surface [mm ²]	2	2	2
Quality level	BIO-CERT® CERTIFIED QUALITY	BIO-CERT® CERTIFIED QUALITY	BIO-CERT® CERTIFIED QUALITY
Lid	-	-	-
Pack of	50 pieces (5 bags of 10 plates)	50 pieces (5 bags of 10 plates)	50 pieces (5 bags of 10 plates)
Cat. No.	781640	781641	781642



Lid for 1536-well plates,
see page 84: Cat. No. 782153



4.2 Microplates for Immunoassays

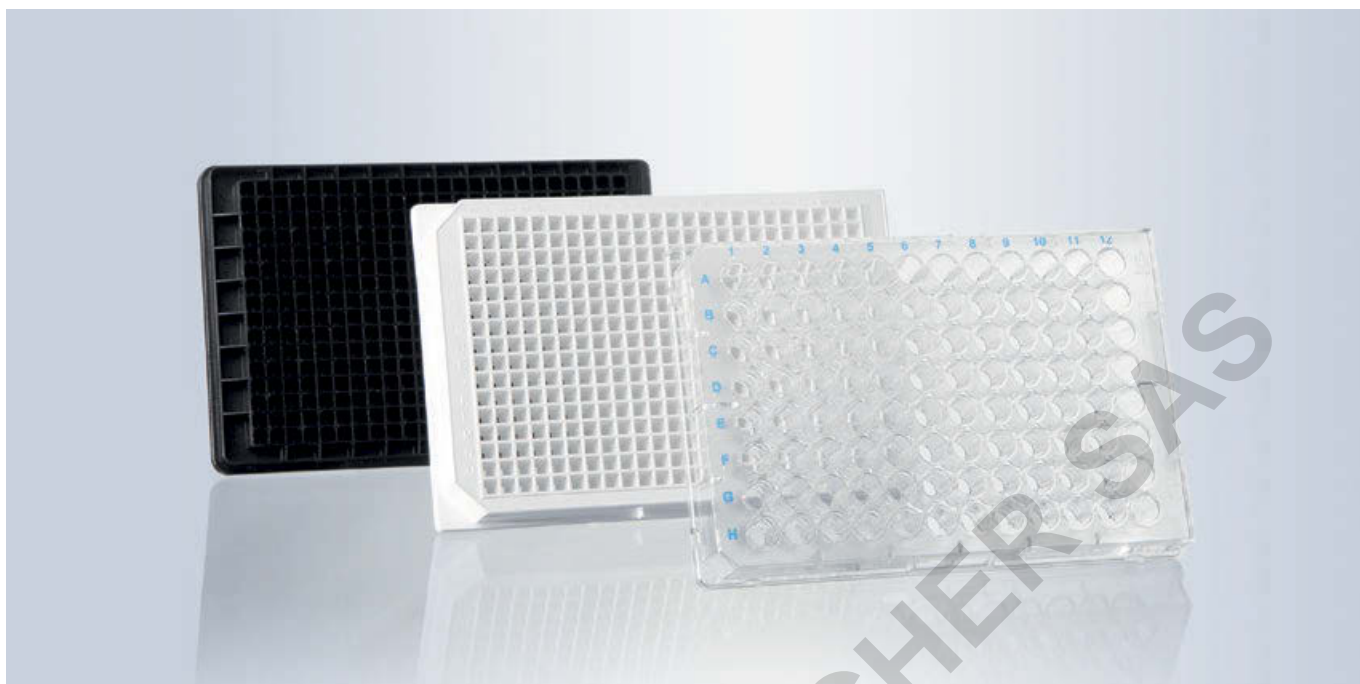

- ✓ Three different surfaces for adsorption of different biomolecules
- ✓ Low well-to-well variance
- ✓ Suitable for direct, indirect and Sandwich ELISA

BRANDplates® microplates immunoGrade™ | hydroGrade™ | lipoGrade™

BRANDplates® for immunoassays are manufactured from pure, newly synthesized polystyrene (PS). Storing large quantities of a raw material batch helps ensure that material-dependent variations in immunological assays can be reduced to a minimum between different assay plate productions.

Blue or embossed alpha-numeric coding for quick and reliable sample identification

Chimney shape of the wells reduces cross-contamination

Pinch bar design supports working with robots



Applications

- + Solid phase assays
- + Homogeneous assays
- + Fluorescence assays
- + Luminescence assays
- + Radioimmuno-assays (RIA)

Features

- + Three different surfaces
- + Different well bottom shapes
- + Strip plates (F8)
- + Compatible with all ANSI/SLAS conforming analytic equipment

User information

Comparison of surface properties

High binding (immunoGrade™)

Highly adsorbent surface for peptides and proteins with a molecular weight > 10 kDa. These plates stand out for their hydrophilic and hydrophobic surface properties, and are highly optimized for binding of IgG and IgA.

Non-specific binding of analytes can result in increased background signals. Because of this, saturating free binding sites can be helpful with this type of plate, to increase the sensitivity of the assay.

Hydrophilized (hydroGrade™)

The percentage of hydrophilic groups in the solid phase is higher when compared to standard high binding surfaces. Microplates with highly hydrophilized surfaces preferably immobilize hydrophilic molecules such as glycoproteins, glycopeptides, and nucleic acids

The interaction between molecules and the surface can be easily influenced by pH level. The accessibility and detection of epitopes by specific antibodies can be impacted by surface-induced conformation changes to the bound molecules.

Strongly hydrophobic (lipoGrade™)

Microplates with a highly hydrophobic surface have an increased affinity to lipophilic biomolecules, such as lipoproteins and lipids. The plates are especially well-suited for liquid phase assays in which reaction components need to remain in a solution since the majority of hydrophilic biomolecules minimally bind to this surface.

Medium binding (pureGrade™)

Microplates with a medium binding surface are very well suited for immobilizing proteins with a molecular weight > 200 kDa. Typically, at this molecule size there are a large number of hydrophobic amino acids present that determine the strength of the interaction with hydrophobic styrol rings on the microplates.

Types

immunoGrade™



- High-binding
- Optimized for the immobilization of IgG and molecules with hydrophilic and hydrophobic regions
- Standard ELISA plate

hydroGrade™



- Strongly hydrophilic
- Increased affinity to biomolecules with primarily hydrophilic regions
- Solid phase with hydrophilic molecules, liquid phase with hydrophobic molecules

lipoGrade™



- Strongly hydrophobic
- Increased affinity to hydrophobic biomolecules
- Solid phase with hydrophobic molecules, liquid phase with hydrophilic molecules

Technical information & Ordering data

immunoGrade™ microplates

Optimized for the immobilization of IgG

- Optimized for the immobilization of IgG, offering highest binding capacity for molecules with mixed hydrophilic and hydrophobic regions.
- The surface of choice for the majority of standard ELISAs.
- Suitable for solid phase immunoassays.
- Comparable to 'high-binding' plates from other manufacturers.



96-well Standard microplates

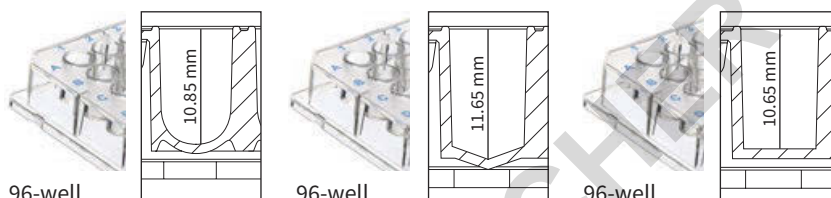

Bottom	U-bottom	V-bottom	F-bottom
Color	transparent	transparent	transparent
Well volume [μl]	330	360	350
Working volume [μl]	40-300	40-330	50-320
Bottom thickness [μm]	850	850	850
Well surface [mm ²]	n.a.	33	32
Lid	-	-	-
Pack of	100 pieces (20 stacks of 5 plates)	100 pieces (20 stacks of 5 plates)	100 pieces (20 stacks of 5 plates)
Cat. No.	781720	781721	781722



96-well Standard microplates

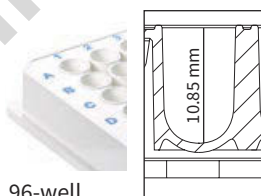

Bottom	U-bottom
Color	white
Well volume [μl]	330
Working volume [μl]	40-300
Bottom thickness [μm]	850
Well surface [mm ²]	n.a.
Lid	-
Pack of	100 pieces (20 stacks of 5 plates)
Cat. No.	781724



Stack of 5 with sleeve



96-well with transparent bottom

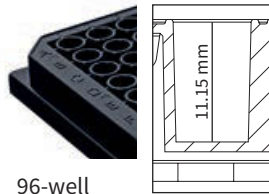

96-well

Bottom	F-bottom	
Color	black	
Well volume [μ l]	330	
Working volume [μ l]	50-310	
Bottom thickness [μ m]	750	
Well surface [mm^2]	31	
Lid	-	-
Pack of	100 pieces (20 stacks of 5 plates)	5 pieces (1 stack of 5 plates)
Cat. No.	781731	781732



96-well strip plates

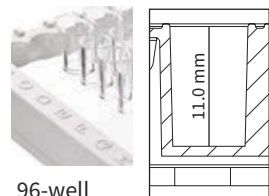

96-well

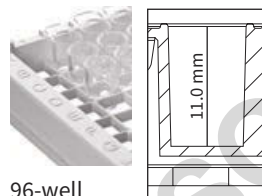

96-well

Bottom	F-bottom	F-bottom
Color	transparent, without grid strips of 8 wells, not divisible	transparent, with grid, strips of 8 divisible
Well volume [μ l]	360	350
Working volume [μ l]	50-320	50-320
Bottom thickness [mm]	1.1	1.1
Well surface [mm^2]	37	37
Lid	-	-
Pack of	100 pieces (4 bags of 25 plates)	100 pieces (4 bags of 25 plates)
Cat. No.	782305	782306



384-well Standard microplates

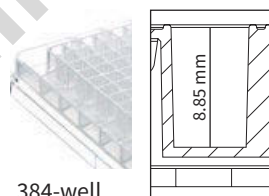

384-well

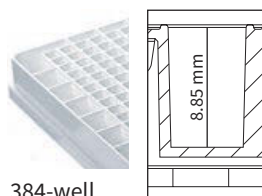

384-well

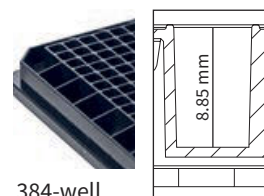

384-well

Bottom	F-bottom	F-bottom	F-bottom
Color	transparent	white	black
Well volume [μ l]	100	100	100
Working volume [μ l]	25-80	25-80	25-80
Bottom thickness [μ m]	650	650	650
Well surface [mm^2]	12	12	12
Lid	-	-	-
Pack of	50 pieces (10 stacks of 5 plates)	50 pieces (10 stacks of 5 plates)	50 pieces (10 stacks of 5 plates)
Cat. No.	781740	781741	781742

Application Note

Comparison of antibody adsorption of BRANDplates® immunoGrade™ with a high binding variant of the competition

Author: BRAND GMBH + CO KG

In ELISAs, reproducibility and precision are dependent on the consistent immobilized quantity of coating antibody (ab). If the quantity of coating ab bound in the well varies, this can result in sample-independent differences that may cause results to be misinterpreted. Therefore, the only variable in an ELISA should be the analyte to be measured.

Because of this, we recommend saturating all free binding sites in a well with coating ab, in order to prevent a false positive signal through non-specific immobilized analytes. However, antibodies must be added in excess to saturate the binding sites, making this process very expensive.

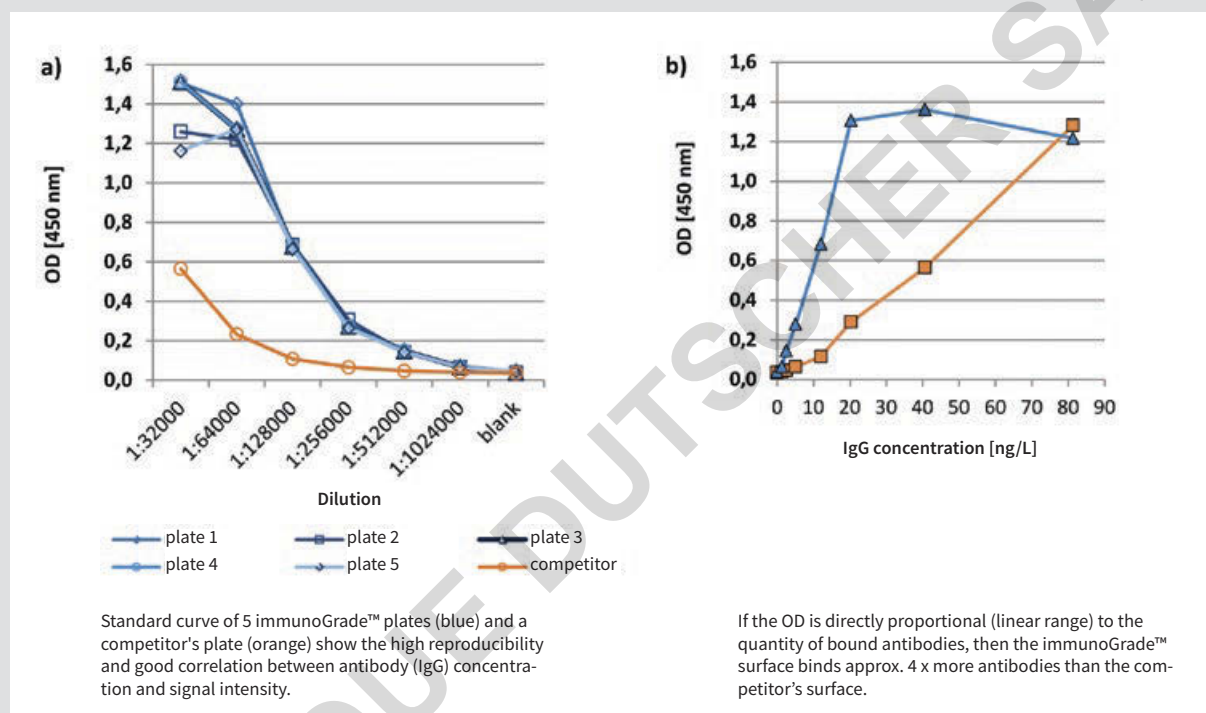

Materials and methods

Transparent 96-well microplates with F-bottom (BRANDplates® immunoGrade™ #781722, BRANDplates® pureGrade™ #781602 and competitor) are incubated with a horseradish peroxidase, HRP-coupled, polyclonal rabbit antibody (IgG, P0214, Dako, Denmark) in increasing dilutions (1:16,000 to 1:1,024,000 in PBS) or decreasing concentrations (81.3 ng/l to 1.3 ng/l) for 2 h at 21 °C and washed. The quantity of HRP-marked antibodies adsorbed by the plastic surface was determined indirectly through absorption (at 450 nm) of the converted TMB substrate (# 34028, ThermoScientific, USA), after adding a stop solution (Photometer EL 808, Biotek, Germany).

Conclusion

In comparison to the competitor plate, the immunoGrade™ surface of the solid BRANDplates® has a significantly higher affinity to the antibodies (immunoglobulin class G; IgG). Higher affinity for the coating antibody means less must be used to saturate the free binding sites, resulting in a cost savings.

hydroGrade™ microplates

For the immobilization of hydrophilic molecules

- Strongly hydrophilic, with high affinity to hydrophilic molecules, such as glycoproteins and peptides, antibodies with predominantly hydrophilic regions, and nucleic acids.
- An alternative to the immunoGrade™ surface when performing solid phase assays.
- Alternative for homogeneous assays with hydrophobic molecules, that remain in solution.



96-well Standard microplates

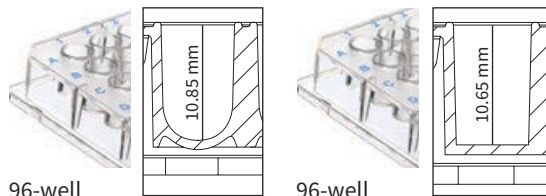

Bottom	U-bottom	F-bottom
Color	transparent	transparent
Well volume [μl]	330	350
Working volume [μl]	40-300	40-300
Bottom thickness [μm]	850	850
Well surface [mm ²]	n.a.	33
Lid	-	-
Pack of	100 pieces (20 stacks of 5 plates)	100 pieces (20 stacks of 5 plates)
Cat. No.	781780	781782

lipoGrade™ microplates

For the immobilization of hydrophobic molecules

- Strongly hydrophobic (lipophilic), for immobilization of biomolecules with predominantly hydrophobic regions.
- For the immobilization of molecules, such as lipoproteins or peptides.
- Specially suited for liquid phase assays when the reaction component should stay in solution.
(The majority of hydrophilic biomolecules are not immobilized on this surface.)



96-well Standard microplates

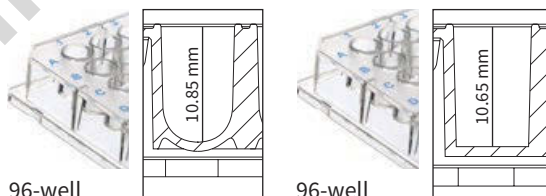

Bottom	U-bottom	F-bottom
Color	transparent	transparent
Well volume [μl]	330	350
Working volume [μl]	40-300	350
Bottom thickness [μm]	850	850
Well surface [mm ²]	n.a.	32
Lid	-	-
Pack of	100 pieces (20 stacks of 5 plates)	100 pieces (20 stacks of 5 plates)
Cat. No.	781840	781842



Lids and films can be found on page 84.

4.3 Microplates for cell culture



- ✓ Low well-to-well variance for good reproducibility
- ✓ cellGrade™ plus and cellGrade™ premium surfaces support serum reduction
- ✓ inertGrade surface for successful cultivation of spheroids and stem cells

BRANDplates® microplates cellGrade™ | cellGrade™ plus cellGrade™ premium | inertGrade™

BRANDplates® microplates with cellGrade™, cellGrade™ plus, cellGrade™ premium and inertGrade™ cell culture surfaces are manufactured from pure, newly synthesized polystyrene (PS). The raw materials used in the plates fulfill the relevant requirements of the USP and ISO 10993. Automated, ISO class 7 cleanroom production ensures the best possible cleanliness.

Orange, alphanumeric coding for reliable, fast sample identification

Chimney shape of the wells reduces cross-contamination

Pinch bar design supports working with robots



Applications

- + Cultivation of adherent cells without additional coatings
- + Cultivation of suspension cells
- + High content screenings
- + Fluorescence assays
- + Luminescence assays

Features

- + High purity, crystal-clear polystyrene
- + Different surfaces for different culture conditions and cell types
- + Sterile plate individually packaged with lid
- + For all ANSI/SLAS conforming analytic equipment
- + Available with bar code

User information

Effects of cell culture surface on morphology and proliferation

inertGrade™

Supports the formation of spheroid cultures preventing early contact-induced differentiation of stem cells, due to cell repellent surface.

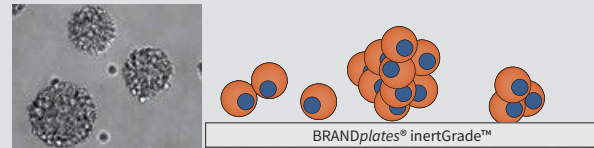

Untreated polystyrene

Supports only restricted adhesion and proliferation of cells. An excellent choice for custom coating with peptides (Poly-D-Lysine or -Ornithin) or extra-cellular matrix proteins.

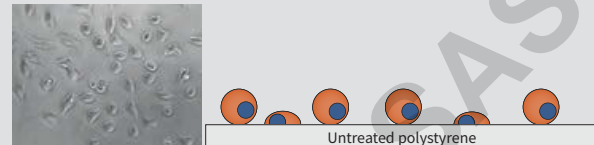

Cell culture-treated polystyrene

Supports the adhesion and proliferation of cells with different origins. For many cell lines, further surface treatment is not required. This reduces preparation time for an assay and avoids the danger of increased well-to-well variance.

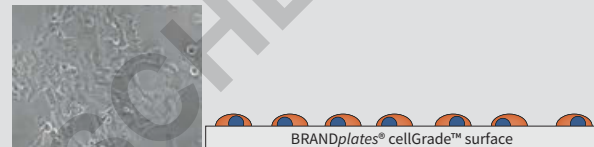

Types

cellGrade™



For the cultivation of adherent cells

- Standard surface for the cultivation of adherent cell lines.
- PS-surface with different chemical groups, such as carboxyl and hydroxyl groups, that are freely accessible.
- Surface is hydrophilic compared with non-treated PS.
- Serum components are easily bound onto the freely accessible chemical groups, allowing an indirect adhesion of cells.

cellGrade™ plus



For reduced-serum media cultivation of cells

- For cultivation of fastidious cell lines.
- In addition to carboxyl and hydroxyl chemical groups, free amino groups are present on the surface.
- The surface has a protein-like composition, so cells can directly attach and spread out.
- Cells adhere faster, better rate of yield.
- Sensitive cell lines can be cultivated.

cellGrade™ premium



Poly-D-Lysine equivalent surface

- Poly-D-Lysine equivalent surface, with analogous results regarding growth performance and cell morphology.
- Optimal adhesion of cells to the surface reduces cell damage when washing frequently.
- Cultivation of cell lines with the highest demands on their environment.
- Surface suited for serum-free and serum-reduced cultivation of cells.
- Good shelf life at room temperature.
- The alternative option to biologically coated surfaces.

inertGrade™



For cultivation of suspension cells

- Especially suited for cell cultures when adhesion is not desired.
- Optimized surface characteristics reduce cell adhesion, protein adsorption and keeps enzyme activation and cellular activation to a minimum.
- Inhibits early differentiation of stem cells.

Technical information & Ordering data

cellGrade™ microplates

Comparison of proliferation and adhesion after washing (CHO cells)

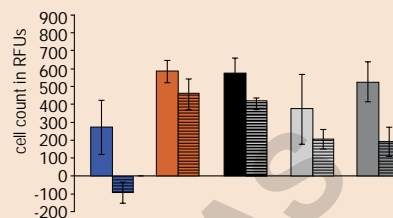
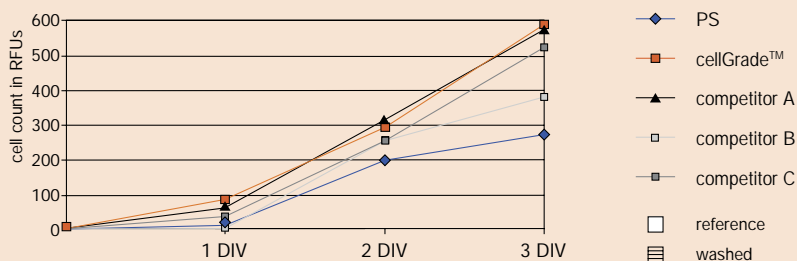

96-well Standard microplates

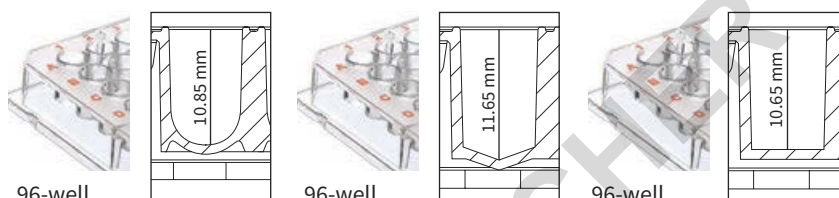

Bottom	U-bottom	V-bottom	F-bottom
Color	transparent	transparent	transparent
Well volume [μl]	330	360	350
Working volume [μl]	40-300	40-330	50-320
Bottom thickness [μm]	850	850	850
Cultivation area [mm ²]	n/a	33	32
	sterile	sterile	sterile
Lid	50 pieces	50 pieces	50 pieces
Pack of	50 pieces (individually wrapped)	50 pieces (individually wrapped)	50 pieces (individually wrapped)
Cat. No.	781960	781961	781962



96-well Standard microplates

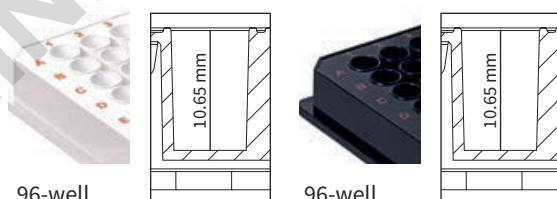

Bottom	F-bottom	F-bottom
Color	white	black
Well volume [μl]	350	350
Working volume [μl]	50-320	50-320
Bottom thickness [μm]	850	850
Cultivation area [mm ²]	32	32
	sterile	sterile
Lid	50 pieces	50 pieces
Pack of	50 pieces (individually wrapped)	50 pieces (individually wrapped)
Cat. No.	781965	781968





96-well

with transparent bottom

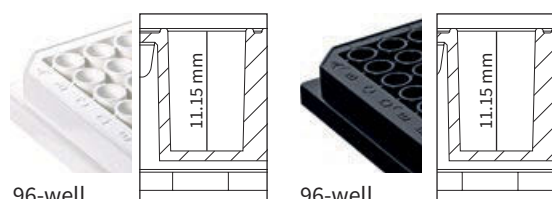

Bottom	F-bottom		F-bottom	
Color	white		black	
Well volume [μ l]	330		330	
Working volume [μ l]	50-310		50-310	
Bottom thickness [μ m]	750		750	
Cultivation area [mm^2]	31		31	
	sterile		sterile	
Lid	50 pieces	5 pieces	50 pieces	5 pieces
Pack of	50 pieces (individually wrapped)	5 pieces (1 bag of 5 pieces)	50 pieces (individually wrapped)	5 pieces (1 bag of 5 pieces)
Cat. No.	781970	781974	781971	781975



384-well

Standard microplates

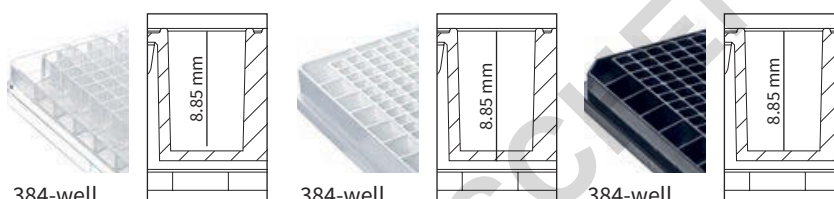

Bottom	F-bottom	F-bottom	F-bottom
Color	transparent	white	black
Well volume [μ l]	100	100	100
Working volume [μ l]	25-28	25-28	25-28
Bottom thickness [μ m]	650	650	650
Cultivation area [mm^2]	12	12	12
	sterile		
Lid	50 pieces		
Pack of	50 pieces (individually wrapped)		
Cat. No.	781980	781981	781982



384-well

with transparent bottom

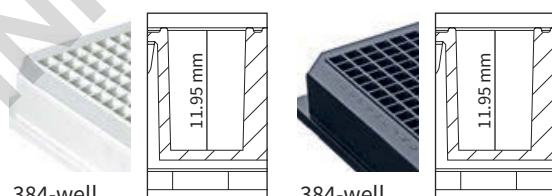

Bottom	F-bottom		F-bottom	
Color	white		black	
Well volume [μ l]	120		120	
Working volume [μ l]	25-100		25-100	
Bottom thickness [μ m]	400		400	
Cultivation area [mm^2]	13		13	
	sterile		sterile	
Lid	50 pieces	1 piece	50 pieces	1 piece
Pack of	50 pieces (individually wrapped)	5 pieces (1 bag of 5 pieces)	50 pieces (individually wrapped)	5 pieces (1 bag of 5 pieces)
Cat. No.	781986	781988	781987	781989

Technical Note

Proliferation of CHO cells on BRANDplates® cellGrade™ surface

Author: BRAND GMBH + CO KG

Culture conditions

For each experiment CHO cells were seeded at a density of 6000 cells/cm² in wells of transparent 96-well F-bottom BRANDplates® (#781962) and cultivated in DMEM medium containing 7% FCS at 37 °C, 95% relative humidity and 5% CO₂.

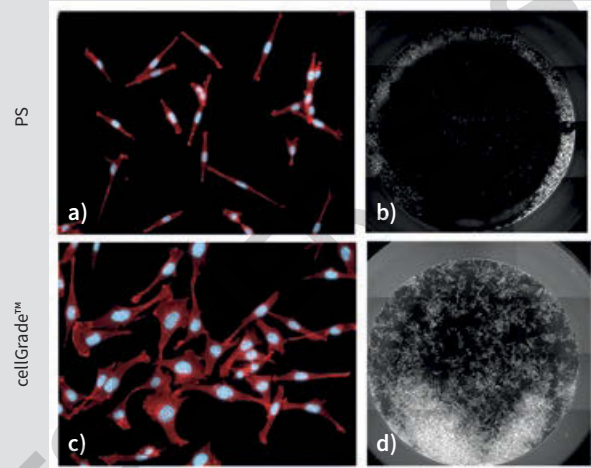
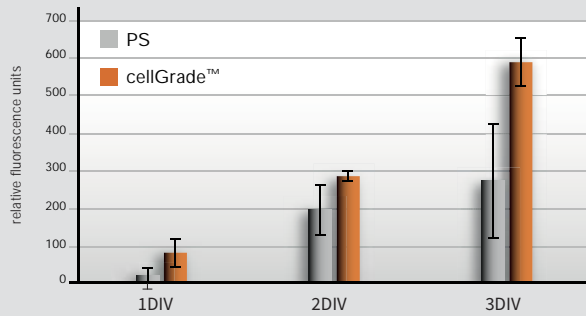

a), c) Phalloidin-TRITC marked F-Aktin (red), nucleus (blue)

CHO cells cultivated on BRANDplates® cellGrade™ show higher fluorescence signals indicating higher cell numbers when compared to non-treated microplates (PS).

b), d) The whole-well scans show significantly improved cell adhesion on the cellGrade™ surface after completing crystal violet staining.

Conclusion

BRANDplates® with cellGrade™ surface perfectly support attachment and proliferation of CHO cells.

Technical information & Ordering data

cellGrade™ plus microplates

Comparison of proliferation and adhesion after washing (HepG2 cells)

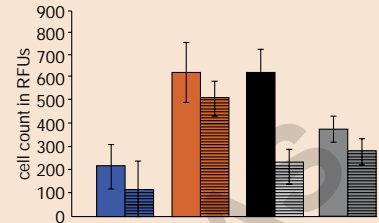
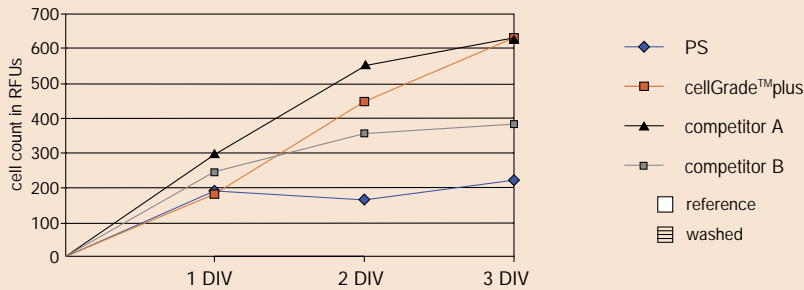

96-well

Standard microplates

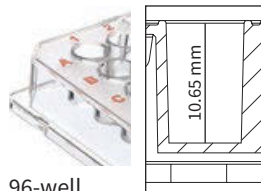

96-well

Bottom

Color
Well volume [μl]
Working volume [μl]
Bottom thickness [μm]
Cultivation area [mm^2]

F-bottom

transparent

350

50-320

850

32

sterile

Lid

50 pieces

Pack of

50 pieces
(individually wrapped)

Cat. No.

782022



96-well

with transparent bottom

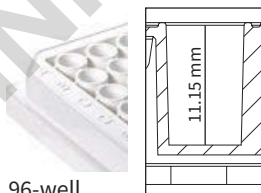

96-well

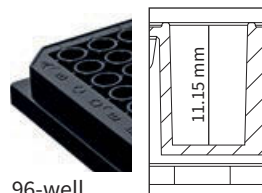

96-well

Bottom

Color
Well volume [μl]
Working volume [μl]
Bottom thickness [μm]
Cultivation area [mm^2]

F-bottom

white

330

50-310

750

31

sterile

Lid

50 pieces

5 pieces

Pack of

50 pieces
(individually wrapped)

5 pieces
(1 bag of 5 pieces)

Cat. No.

782030

782034

F-bottom

black

330

50-310

750

31

sterile

50 pieces

5 pieces

50 pieces
(individually wrapped)

5 pieces
(1 bag of 5 pieces)

782031

782035

Technical Note

Proliferation of HEK293 cells on BRANDplates® cellGrade™ plus surface

Author: BRAND GMBH + CO KG

Culture conditions

For each experiment HEK293 cells were seeded at a density of 6000 cells/cm² in wells of transparent 96-well F-bottom BRANDplates® (#782022) and cultivated in DMEM medium containing 7% FCS at 37 °C, 95% relative humidity and 5% CO₂.

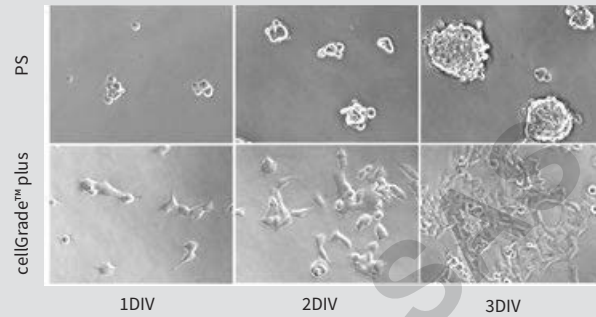
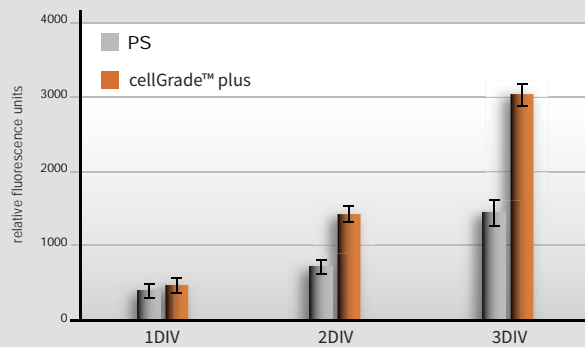

Comparative phase contrast images of HEK293 cells cultivated in untreated (PS) and cellGrade™ plus treated micro-plates. DIV days in vitro, (200x zoom)

Conclusion

BRANDplates® with cellGrade™ plus surface perfectly support attachment and proliferation of HEK293 cells.

Technical information & Ordering data

cellGrade™ premium microplates

comparison of proliferation (HeLa cells)

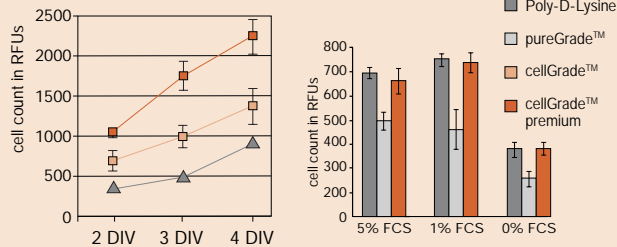

Actin cytoskeleton (red) with cell nucleus (blue)

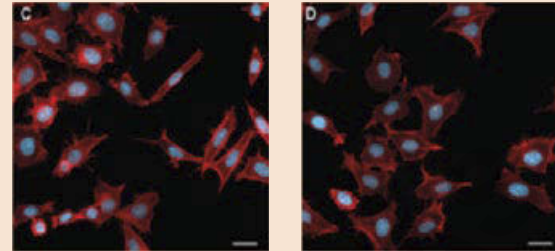

cellGrade™ premium

Poly-D-Lysine



96-well

Standard microplates

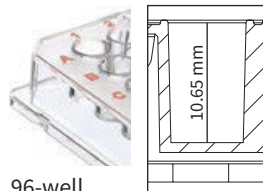

96-well

Bottom

Color
Well volume [μl]
Working volume [μl]
Bottom thickness [μm]
Cultivation area [mm ²]

F-bottom

transparent

350

50-320

850

32

sterile

Lid

50 pieces

Pack of

50 pieces
(individually wrapped)

Cat. No.

782082



96-well

with transparent bottom



96-well

Bottom

Color
Well volume [μl]
Working volume [μl]
Bottom thickness [μm]
Cultivation area [mm ²]

F-bottom

white

330

50-310

750

31

sterile

Lid

50 pieces

5 pieces

Pack of

50 pieces
(individually wrapped)

5 pieces
(1 bag of 5 pieces)

Cat. No.

782090

782094

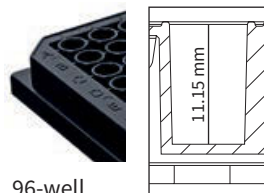

96-well

Bottom

Color
Well volume [μl]
Working volume [μl]
Bottom thickness [μm]
Cultivation area [mm ²]

F-bottom

black

330

50-310

750

31

sterile

Lid

50 pieces

5 pieces

Pack of

50 pieces
(individually wrapped)

5 pieces
(1 bag of 5 pieces)

Cat. No.

782091

782095

Application Note

High yields of transfected cells with BRANDplates® cellGrade™ premium surface

Author: Martin Liss, Sabine Kraft Neuromuscular & Cardiovascular Cell Biology, Max-Delbrück-Centrum Berlin, Germany

Introduction

Transfection is defined as non-viral DNA/gene delivery into eukaryotic cells performed by several chemical, physical or biological methods. The subsequent exogenous expression of a tagged protein in cell culture is a well established approach to investigate function and localization of the protein of interest. In normal culture medium, nucleases present in serum could degrade DNA while other serum components tend to form complexes with nucleic acids, thereby reducing the availability of DNA for transfection [Ref.1]. To avoid such interference, serum free culture medium is required for successful transfections. However, serum deprivation

can reduce cell viability, proliferation and attachment. To partially compensate for these negative effects arising from serum deprived culture conditions, special modifications of cell culture surfaces have been developed to support cell attachment and increase cellular yields after transfection. Here we compare 3 different microplate surfaces regarding their ability to support proliferation and attachment of transfected cells during washing steps. It is shown, that on the cellGrade™ premium surface transfected cells were retained in same quantity when compared to 96-well microplates of other manufacturers.

Material and Methods

HEK293.EBNA cells were cultured in DMEM 4.5 g/L Glucose with L-glutamine supplemented with 10% fetal bovine serum and 100 units/mL penicillin/streptomycin. Cells were seeded in comparable tissue culture treated black 96-well microplates with transparent bottoms and grown at 37 °C with 5% CO₂. A total of 200 ng/well GFP-encoding plasmid-DNA pEGFP-C1 was used to transfect cells using 40 kDa linear polyethylenimine at a ratio of 1:3 DNA:PEI40 24 hrs later [Ref.2]. After an incubation of 72 hrs, culture medium

was changed to PBS and one set of cultures from each microplate was washed additional 2 times with 200 µL PBS at 37 °C using an electronic multichannel pipette at lowest dispensing speed in order to not disturb the cell monolayer. For read-out a TECAN Infinite® M200 PRO was used to detect the remaining relative fluorescent units (RFUs) at ex485/em535 nm. The detector of the plate reader was adjusted according to the highest signal intensity to be measured.

Results

A transfection mastermix was used to transfect cultured cells on different plates in order to achieve comparable transfection efficiency (Fig.1).

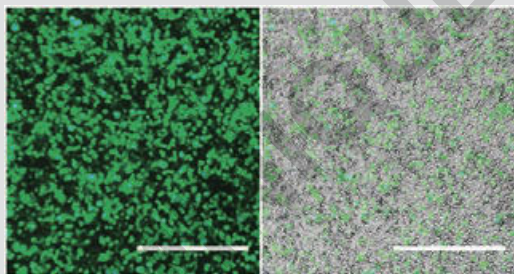

Figure 1: Example of transfected HEK293.EBNA cells expressing GFP 72 hrs post-transfection. Scale bar 500 µm.

To ensure an equal pipetting strength during washing an electronic multichannel pipette was used. In this case the only variable is the TC culture surface of different manufacturers. The quantification of relative GFP fluorescence units shows that cellGrade™ premium surface promote proliferation of transfected cells and retain GFP expressing cells after washing to the same extent as TC-treated microplates from competitors.

Conclusion

BRANDplates® cellGrade™ premium surface can improve experimental performance when cell proliferation or cell binding to culture surface is critical.

References:

- 1: D. Llères, J.M. Weibel, D. Heissler, G. Zuber, G. Duportail, Y. Mély, Dependence of the cellular internalization and transfection efficiency on the structure and physicochemical properties of cationic detergent/DNA/liposomes, J. Gene. Med. 6 (2004) 415–428.
- 2: SP. Huh et al., Optimization of 25 kDa linear polyethylenimine for efficient gene delivery, Biologicals. (2007), 35(3):165-71.

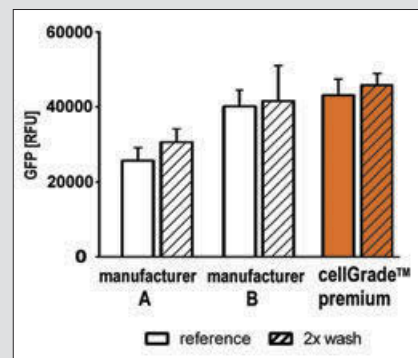
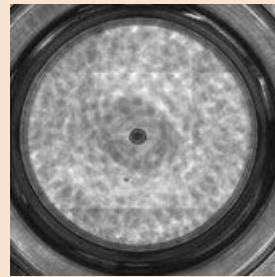

Figure 2: Measurement of GFP relative fluorescence units (RFU) shows the good performance of BRANDplates® cellGrade™ premium surface in promoting proliferation and attachment of transfected HEK293.EBNA cells.

Technical information & Ordering data

inertGrade™ microplates

- Surface effectively suppresses cell adhesion
- For cultivating stem cells
- Ideal for generating tumor spheroids



Wells can of U-bottom plate (781900) with single spheroid formed by L292 cells.

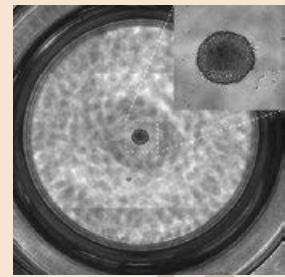

Close-up of the spheroid



96-well

Standard microplates

Bottom	U-bottom	F-bottom
Color	transparent	transparent
Well volume [μl]	330	350
Working volume [μl]	40-300	50-320
Bottom thickness [μm]	850	850
Cultivation area [mm ²]	n.a.	32
	sterile	sterile
Lid	50 pieces	50 pieces
Pack of	50 pieces (individually wrapped)	50 pieces (individually wrapped)
Cat. No.	781900	781902



96-well

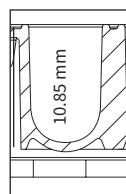

96-well

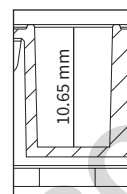

96-well

with transparent bottom

Bottom	F-bottom	F-bottom		
Color	white	black		
Well volume [μl]	330	330		
Working volume [μl]	50-310	50-310		
Bottom thickness [μm]	750	750		
Cultivation area [mm ²]	31	31		
	sterile	sterile		
Lid	50 pieces	5 pieces	50 pieces	5 pieces
Pack of	50 pieces (individually wrapped)	5 pieces (1 bag of 5 pieces)	50 pieces (individually wrapped)	5 pieces (1 bag of 5 pieces)
Cat. No.	781910	781912	781911	781913



96-well

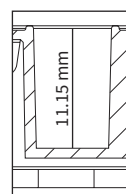

96-well

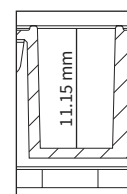

Application Note

BRANDplates® inertGrade™

Author: Dr. Benedikt Busse, zell-kontakt GmbH, Nörten-Hardenberg, Germany

In many cell culture techniques, such as producing tumor spheroids or embryoid bodies, the suppression of integrin-mediated adhesion to surfaces plays a crucial role.

The illustration shows that adherent growing cell lines can be made to form spheroids with a comparably high cell division rate by cultivating them on the inertGrade™ cell culture surface.

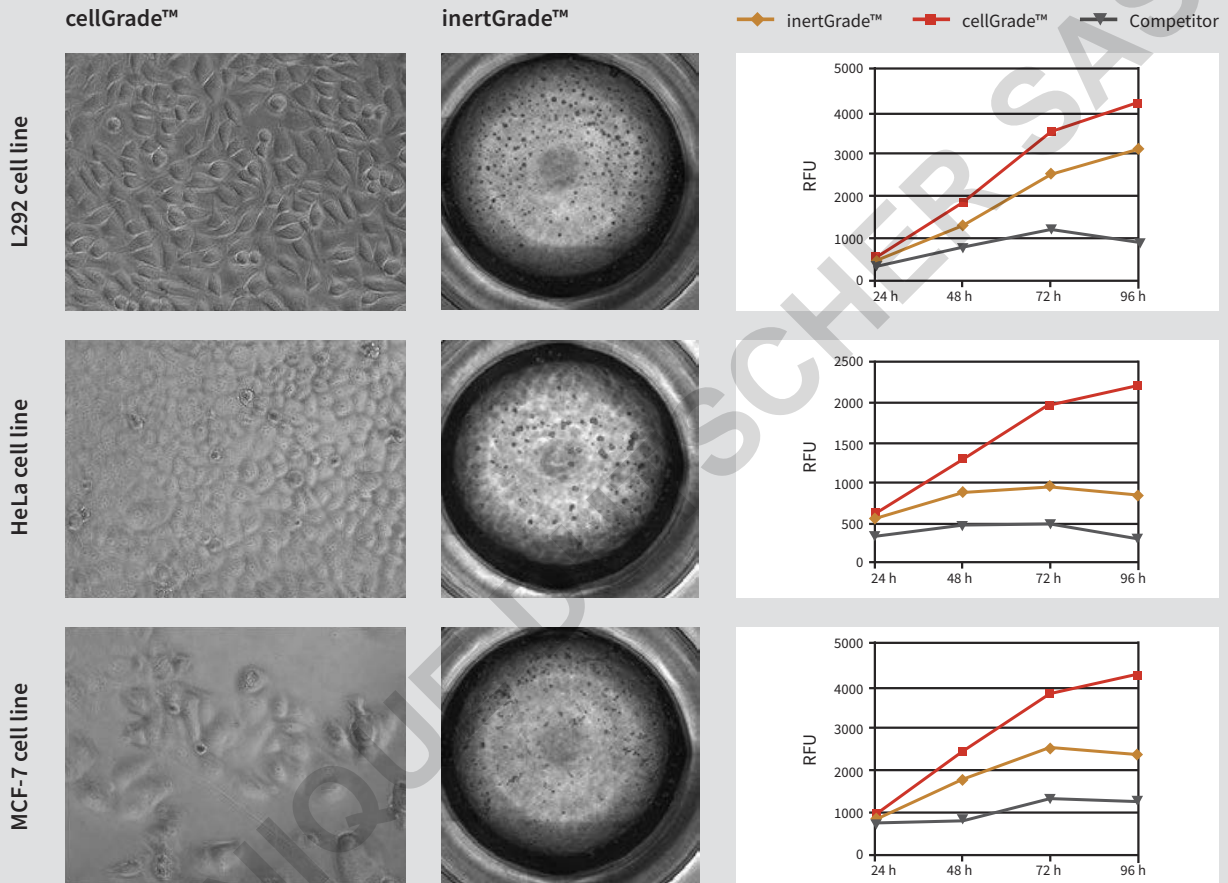

The cell-repellent surface of the BRANDplates® inertGrade™ also demonstrates effective suppression of cell adherence when cultivating stem cells. This prevents contact-induced and uncontrolled differentiation and maintains the stem cell character.

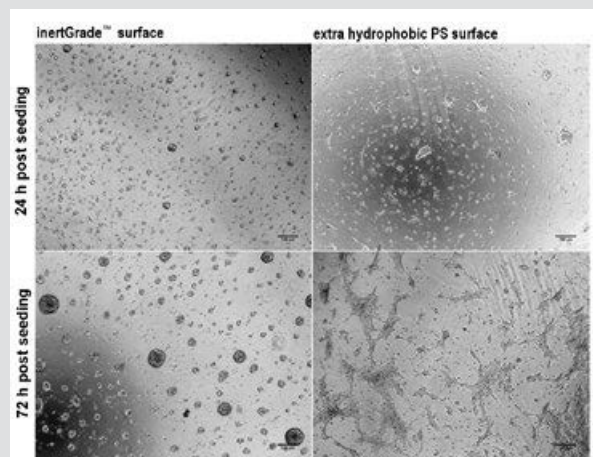

Application note "Formation of spheroids and suppression of adhesion by adherent growing cells in inertGrade™ microplates", see www.brand.de

At a glance



96-well microplates

Type		Non-treated		Immunological surfaces			Cell culture surfaces			
Standard		pureGrade™	pureGrade™ S	immunoGrade™	hydroGrade™	lipoGrade™	cellGrade™	cellGrade™ plus	cellGrade™ premium	inertGrade™
Color	Bottom / Well volume									
transparent	U / 330 µl	781600	781660	781720	781780	781840	781960	–	–	781900
transparent	V / 360 µl	781601	781661	781721	–	–	781961	–	–	–
transparent	F / 350 µl	781602	781662	781722	781782	781842	781962	782022	782082	781902
transparent	C / 350 µl	781603	781663	–	–	–	–	–	–	–
white	U / 330 µl	781604	–	781724	–	–	–	–	–	–
white	F / 350 µl	781605	781665	–	–	–	781965	–	–	–
white	C / 350 µl	–	–	–	–	–	–	–	–	–
black	U / 330 µl	781607	–	–	–	–	–	–	–	–
black	F / 350 µl	781608	781668	–	–	–	781968	–	–	–
black	C / 350 µl	–	–	–	–	–	–	–	–	–
With transparent bottom		pureGrade™	pureGrade™ S	immunoGrade™	hydroGrade™	lipoGrade™	cellGrade™	cellGrade™ plus	cellGrade™ premium	inertGrade™
white	F / 330 µl	781610	781670	–	–	–	781970	782030	782090	781910
white*	F / 330 µl	–	–	–	–	–	781974	782034	782094	781912
black	F / 330 µl	781611	781671	781731	–	–	781971	782031	782091	781911
black*	F / 330 µl	–	–	781732	–	–	781975	782035	782095	781913
With UV film bottom		pureGrade™	pureGrade™ S	immunoGrade™	hydroGrade™	lipoGrade™	cellGrade™	cellGrade™ plus	cellGrade™ premium	inertGrade™
transparent	F / 350 µl	781614	–	–	–	–	–	–	–	–
black	F / 350 µl	781615	–	–	–	–	–	–	–	–
Strip plates		pureGrade™	pureGrade™ S	immunoGrade™	hydroGrade™	lipoGrade™	cellGrade™	cellGrade™ plus	cellGrade™ premium	inertGrade™
transparent, without grid	F / 360 µl	782300	–	782305	–	–	–	–	–	–
transparent, with grid	F / 350 µl	782301	–	782306	–	–	–	–	–	–

* not available in USA

* Pack of 5

384-well HTS microplates

Type		Non-treated		Immunological surfaces			Cell culture surfaces			
Standard		pureGrade™	pureGrade™ S	immunoGrade™	hydroGrade™	lipoGrade™	cellGrade™	cellGrade™ plus	cellGrade™ premium	inertGrade™
Color	Bottom / Well volume									
transparent	F / 100 µl	781620	781680	781740	–	–	781980	–	–	–
white	F / 100 µl	781621	781681	781741	–	–	781981	–	–	–
black	F / 100 µl	781622	781682	781742	–	–	781982	–	–	–
With transparent bottom		pureGrade™	pureGrade™ S	immunoGrade™	hydroGrade™	lipoGrade™	cellGrade™	cellGrade™ plus	cellGrade™ premium	inertGrade™
white	F / 120 µl	781626	781686	–	–	–	781986	–	–	–
white*	F / 120 µl	–	–	–	–	–	781988	–	–	–
black	F / 120 µl	781627	781687	–	–	–	781987	–	–	–
black*	F / 120 µl	–	–	–	–	–	781989	–	–	–

* Pack of 5

1536-well UHTS microplates

Type		Non-treated		Immunological surfaces			Cell culture surfaces			
Standard		pureGrade™	pureGrade™ S	immunoGrade™	hydroGrade™	lipoGrade™	cellGrade™	cellGrade™ plus	cellGrade™ premium	inertGrade™
Color	Bottom / Well volume									
transparent	F / 10 µl	781640	–	–	–	–	–	–	–	–
white	F / 10 µl	781641	–	–	–	–	–	–	–	–
black	F / 10 µl	781642	–	–	–	–	–	–	–	–

4.4 Cell culture inserts

4.4.1 Multiwell plates



- ✓ Optimal cell growth thanks to cellGrade™ plus surface
- ✓ Side well access for easier pipetting and removing cover slips
- ✓ Perfect positioning of the BRANDplates® insert

BRANDplates® multiwell plates offer better functionality than commonly available multiwell plates. Each well of the 24-well and 6-well plates has an additional extension on the edge of the well to serve as a pipette and forceps access point. This “feeding port” allows the well to be accessed even with a mounted BRANDplates® Insert. The additional space in the “feeding port” creates an ideal lever point for forceps to grip cover glasses without scratching them and damaging cultivated cells on the glasses.

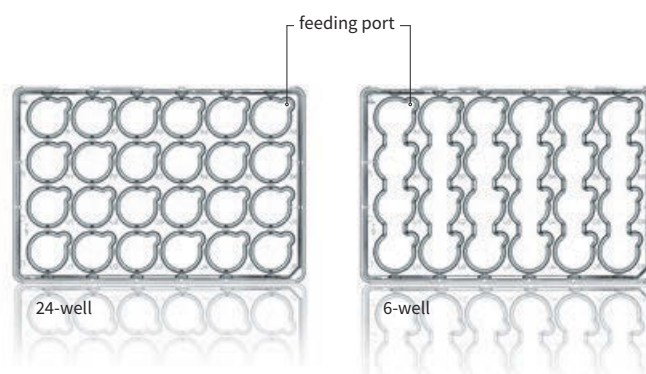

Applications

- + Cultivation of adherent cells
- + Cultivating cells on cover glasses
- + Mounting BRANDplates® inserts and insert strips
- + Automated cell culture applications

Features

- + High purity, crystal-clear polystyrene
- + Conforms to ANSI/SLAS Standards 1 and 4
- + Manufactured in an ISO Class 7 cleanroom
- + Individually wrapped with lid, sterile (SAL 10⁻⁶)
- + Untreated or cell culture treated

User information

**24-well standard plate**

The plate includes 24 individually fillable wells that can be fitted with strips of 4 inserts and/or individual inserts

Format	24-well	6-well
Well surface [mm ²] (incl. feeding port)	210	855
Working volume [ml]	3.1	10



Guide grooves in the standard 24-well plates

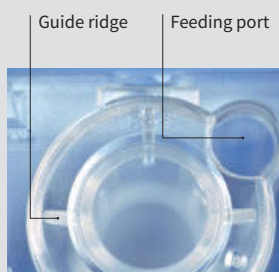

Guide ridge Feeding port

**6-well special plate**

The 4 wells are all connected as one large, elongated well. This well can be fitted with a strip of 4 inserts so that all 4 of the inserts in the strip can be supplied with medium at the same time. Particularly well suited to the use of insert strips with inlet channels. Also suitable for single inserts and 2 or 3 connected inserts.

The well and insert are perfectly coordinated

The guide grooves in the support collars of the wells in the 24-well standard plate hold the guide ridges of the insert in position. This prevents the individual inserts from rotating – the feed ports on the wells remain open. At the same time, the guide ridges center the insert in the well.

Accessories



Information on accu-jet® S pipette controller and Transferpette® S microliter pipette is available at shop.brand.de, while information on counting chambers and centrifuge tubes is available on pages 11 and 17.

Technical information & Ordering data



24-well and 6-well Multiwell plates

Surface	pureGrade™ S	cellGrade™ plus	pureGrade™ S	cellGrade™ plus
Wells	24	24	6	6
Working volume [ml]	3.1	3.1	8 - 10	8 - 10
Growth surface [mm ²]	210	210	855	855
Lid	with lid	with lid	with lid	with lid
Pack of	10 pieces (individually wrapped)	10 pieces (individually wrapped)	10 pieces (individually wrapped)	10 pieces (individually wrapped)
Cat. No.	782880	782890	782881	782891

4.4.2 Inserts



- ✓ Optimal cell growth thanks to cell culture treatment
- ✓ Add up to four inserts at once
- ✓ Fast, safe handling

Cell culture inserts with microporous membranes greatly expand the range of methods that can be used in classic cell cultures.

The innovative BRANDplates® insert system offers a product perfectly adapted to reconstructing 3D epithelial models. The strip format ensures that the inserts sit in the well without rotation, and the 6-well plate allows for medium exchange in up to four inserts at once.



4-insert strips, divisible into up to 4 individual inserts – positioned to hang in the well

Applications

- + Epithelial cell cultures
- + Barrier analysis
- + Polarization studies
- + Epidermis models
- + Full skin models
- + Co-cultures
- + Impedance measurements

Features

- + Cell culture treated PC or PET membranes
- + Culture surface 0.6 cm²
- + As 4x strips or individual
- + Strips divisible
- + Manufactured in an ISO Class 8 cleanroom
- + Sterile (SAL 10⁻⁶)

User information

Advantages of specialized insert-plate combinations

A 3D culture of 0.6 cm² should be supplied with at least 1 ml of medium per day, in particular during cultivation at the air-liquid interphase. Medium must also be exchanged with the same frequency.

The BRAND insert system offers a variety of solutions to increase the provided basal volume (below the membrane) and reduce the number of medium changes.

24-well plate with 13 mm insert strip

Standard conditions for 3D cell cultures with high nutrient requirements.

Smooth-walled inserts, suitable for differentiation, transportation, co-cultivation, transmigration and cell polarity assays.

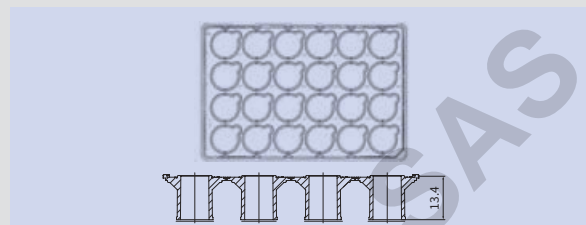

24-well plate with 9 mm insert strip

Ideal for cultures at the air-liquid interphase (ALI)

ALI cultures are supplied with 1.7 ml of medium per 24-well. This combination greatly optimizes the medium supply to ALI cultures.

Not suitable for transportation, transmigration and cell polarity assays.

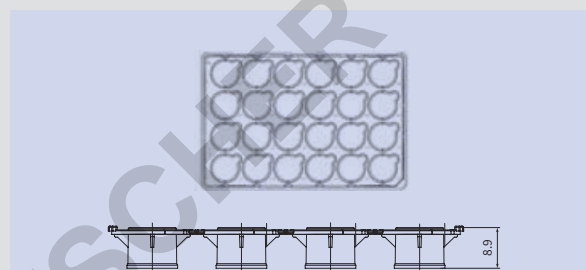

6-well plate with 13 mm insert strip

Ideal for more complex 3D cultures, such as full skin models.

When using just 2 inserts per well, each ALI culture is supplied with 1.75 ml. This means that up to 12 epithelial models can be cultivated in one plate, saving space.

The smart 6-well design facilitates simultaneous medium exchange for all of the inserts in a series.

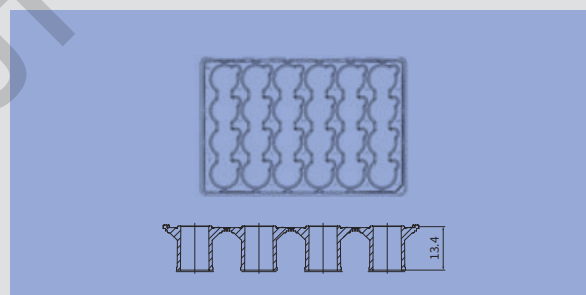

6-well plate with 9 mm insert strip

Excellent supply for cells during an air-liquid interphase culture.

When using a full strip, each culture is supplied with 2 ml of medium. Using half strips increases the basal volume to 4 ml per culture.

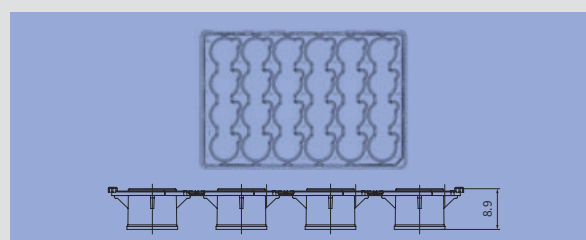

Co-culture:

Membranes with pore sizes of 0.4 and 1.0 μm. Use PET membranes for good cell visibility under an optical microscope. PC membranes with comparable pore sizes have a higher pore density, improving interaction between the cells than PET membranes. PC membranes, however, are not recommended for transmitted light microscopes.

Chemotaxis and transmigration:

Depending on the cell type, transmigration assays can be accomplished with pore sizes above 3.0 μm. Use PET membranes for microscopic applications.

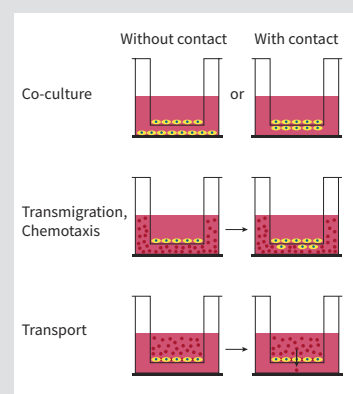

User information

Importance and function of the Inlet Opening System (IOS)

When removing apical medium in cultures of reconstructed epithelial models, there is a danger of injuring tissue cultures with pipette tips, making the tissue culture unusable in further examinations.

The Inlet Opening System of the BRANDplates® Insert makes it possible to adjust the medium levels in inserts by controlling the medium level in the corresponding wells.

In addition to improved reliability, combining 6-well plates and inserts with IOS can reduce pipetting work for 4 inserts in fused well row from eight aspiration and filling steps to just one aspiration and one filling step. This drastically reduces the time that the cultures spend outside of the incubator, making it possible to greatly reduce the effects of temperature and pH fluctuations.

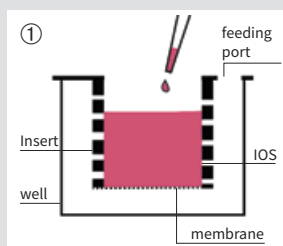

During cell seeding or applying coatings, the unique geometry of the Inlet Opening System (IOS) prevents the insert from leaking

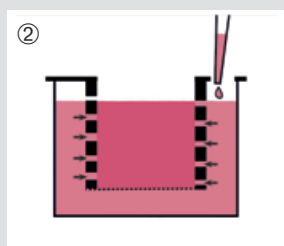

The submersion culture is also established by adding medium to the well. The arrow indicate that the medium flows evenly into the interior of the insert.

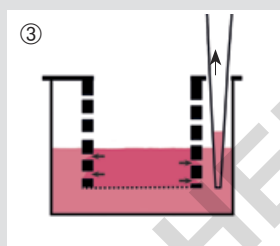

The IOS accelerates and simplifies the medium exchange. The arrows show the direction of flow for the medium from the insert into the well where the aspiration pipette is placed.

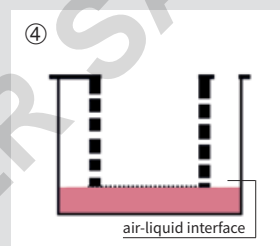

This allows the air-liquid interface to be adjusted without the risk of tissue damage.

Possible causes for poor adhesion of cells in assay plates:

- The passage used in the cell line is too high and the cells are senescent
- The seeding density is too low
- The medium used is inadequate
- Cells are contaminated
- Cells require a specific substrate (laminin, collagen, vitronectin, fibronectin)

Recommended volumes for different culture phases of the 3D culture

	24-well	6-well	24-well	6-well
Insert height [mm]	13	13	9	9
Insert [μ l] (such as coating, cell seeding)	150 - 400	150 - 400	150 - 250	150 - 250
Well: Submersion culture [ml] with added insert	1.6 - 2	8 - 10	2.2 - 2.5	9 - 10
Well: air-liquid-interphase [ml] (of basal coated membrane)	0.8	3.5	1.8	8

Membrane pore size / application examples

Pore size	Areas of application
0.4 μ m	Co-culture, transport studies, secretion studies, cell polarity studies, etc.
1.0 μ m	Co-culture, transport studies, secretion studies, etc.
3.0 μ m	Migration studies, chemotaxis studies, metastasis experiments, etc.
8.0 μ m	Migration studies, chemotaxis studies, metastasis experiments, etc. See also the construction of full-thickness skin models (www.tissue-factory.com)

Membrane properties

Membrane	Pore size	Pore density	Optic
PC membrane	0.4 μ m	$1 \times 10^8 \text{ cm}^2$	translucent
	1.0 μ m	$2 \times 10^7 \text{ cm}^2$	translucent
	3.0 μ m	$2 \times 10^6 \text{ cm}^2$	translucent
	8.0 μ m	$1 \times 10^5 \text{ cm}^2$	translucent
PET membrane	0.4 μ m	$2 \times 10^6 \text{ cm}^2$	transparent
	8.0 μ m	$1 \times 10^5 \text{ cm}^2$	translucent



Technical information & Ordering data



Insert Strips

PC membrane

Pore size	0.4 μm	1.0 μm	3.0 μm	8.0 μm
Pore density per cm^2	1×10^8	2×10^7	2×10^6	1×10^5
Growth area [cm^2]	0.6	0.6	0.6	0.6
Insert height [mm]	13	9	13	13
Pack of	12 pieces (12 strips x 4 inserts)	12 pieces (12 strips x 4 inserts)	12 pieces (12 strips x 4 inserts)	12 pieces (12 strips x 4 inserts)
Type	smooth-walled	smooth-walled	smooth-walled	smooth-walled
Cat. No.	782800 782900	782820	782840	782860
Type	IOS	IOS	IOS	IOS
Cat. No.	782801 782901	782821	782841	782861

PET membrane

Pore size	0.4 μm	8.0 μm
Pore density per cm^2	2×10^6	1×10^5
Growth area [cm^2]	0.6	0.6
Insert height [mm]	13	9
Pack of	12 pieces (12 strips x 4 inserts)	12 pieces (12 strips x 4 inserts)
Type	smooth-walled	smooth-walled
Cat. No.	782810 782910	782870
Type	IOS	IOS
Cat. No.	782811 -	782871



You need bulk packages? Five 6-well plates filled with 6 insert strips each (120 inserts) can be ordered at www.info@brand.de



Individual inserts

PC membrane

Pore size	0.4 μm	1.0 μm	3.0 μm	8.0 μm
Pore density per cm^2	1×10^8	2×10^7	2×10^6	1×10^5
Growth area [cm^2]	0.6	0.6	0.6	0.6
Insert height [mm]	13	13	13	13
Pack of	48 pieces	48 pieces	48 pieces	48 pieces
Type	smooth-walled	smooth-walled	smooth-walled	smooth-walled
Cat. No.	782806	782826	782846	782866

PET membrane

Pore size	0.4 μm	8.0 μm
Pore density per cm^2	2×10^6	1×10^5
Growth area [cm^2]	0.6	0.6
Insert height [mm]	13	13
Pack of	48 pieces	48 pieces
Type	smooth-walled	smooth-walled
Cat. No.	782816	782876



4.4.3 Insert 2in1



- ✓ Can be used standing or suspended
- ✓ Flexible and easy to use
- ✓ Cell culture treated membrane for optimal cell growth

The smart design of the BRAND Insert 2in1 allows for almost unrestricted compatibility with all ANSI/SLAS standard multiwell plates. In addition, it is the only cell culture insert of its kind that can be suspended in the well plates without additional support plates. This allows the 2in1 Insert from BRAND to provide the flexibility you need in establishing new experimental approaches.

Three point mounting

Hook and adjacent feet ensure precise positioning parallel to the well bottom.

Membranes

USP class VI tested with cellGrade™ plus functional surfaces



Feet

For standing use; ensures ~ 1 mm gap between membrane and bottom of the dish or well.

Applications

- + Transmigration and invasion assays
- + Toxicity assessments
- + Tissue engineering
- + Barrier and transportation studies
- + Co-cultivation
- + Polarity testing
- + Cell polarization studies

Features

- + Use in a hanging or standing position
- + Works with all common 6-, 12-, or 24-well plates
- + Surface: cellGrade™ plus
- + PC or PET membrane
- + Pore size: 0.4 µm and 8.0 µm
- + Manufactured in cleanroom ISO class 8

User information

Hanging

If you use the Insert 2in1 as a hanging insert, add the medium to the multiwell plates before hanging the insert inside the wells (make sure the medium comes into contact with the membrane). Then fill the insert with medium.

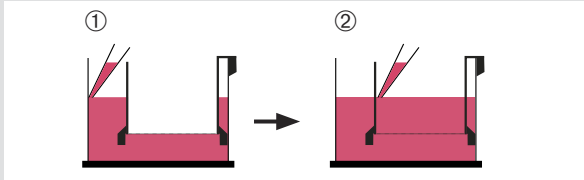

Standing

If you would like to use the Insert 2in1 as a standing insert, place the insert into the provided multiwell plate or culture dish. Add the medium to the insert and then into the well or the culture dish.

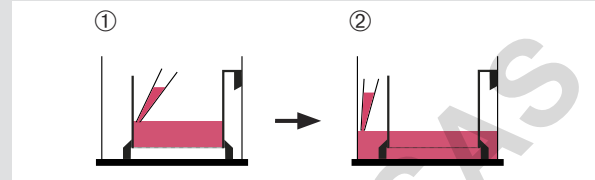

Common applications

Co-culture

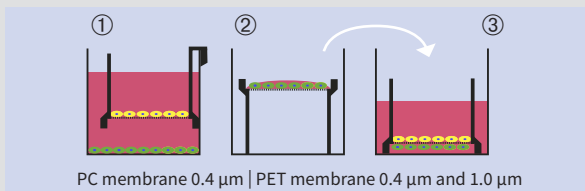

Air-lift culture in multiwell plate

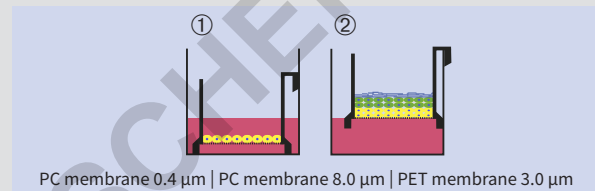

Transmigration, chemotaxis

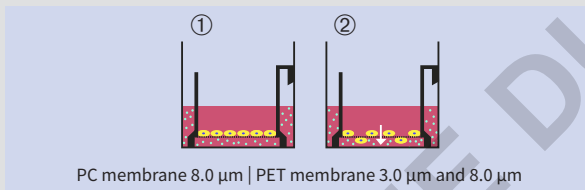

Transport/barrier analysis (TEER measurement), cytotoxicity

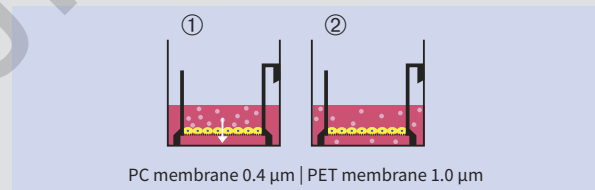

Air-lift culture in culture dish

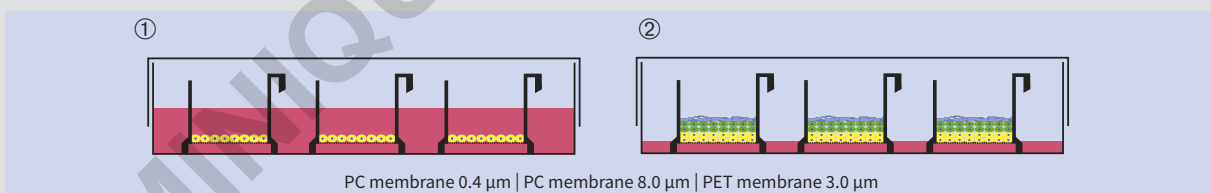

Membrane properties

Membrane	Pore size	Pore density	Optic
PC membrane	0.4 µm	1 x 10 ⁸ cm ²	translucent
	8.0 µm	1 x 10 ⁵ cm ²	translucent
PET membrane	0.4 µm	2 x 10 ⁶ cm ²	transparent
	1.0 µm	2 x 10 ⁶ cm ²	transparent
	3.0 µm	2 x 10 ⁶ cm ²	transparent
	8.0 µm	1 x 10 ⁵ cm ²	translucent

Working volume and culture area

Well	Working volume	Culture area
24-well	150 - 400 µl	0.6 cm ²
12-well	300 - 1000 µl	1.38 cm ²
6-well	800 - 3000 µl	4.83 cm ²

Increased sample volume with air-liquid interphase cultures? Switch to the BRANDplates® Insert System (see p. 72): same membrane, same culture surface as 24-well inserts, less time-wasting culture optimizations than when switching from other manufacturer systems.



Technical information & Ordering data

BRAND Insert 2in1

- TC treated (cellGrade™ plus) PC- and PET membranes
- Can be used with all common 24-, 12- and 6-well plates
- Use in hanging or standing position
- Individually packed or in multi-packs



Single blister



24-well Insert 2in1 PC membrane

Pore size	0.4 µm	8.0 µm		
Pore density per cm ²	1 x 10 ⁸	1 x 10 ⁵		
Growth area [cm ²]	0.6	0.6		
Insert height [mm]	10	10		
Type	single blister	multi-pack	single blister	multi-pack
Pack of	48 pieces	4 x 12 pieces	48 pieces	4 x 12 pieces
Cat. No.	782700	782701	782706	782707



12-well Insert 2in1 PC membrane

Pore size	0.4 µm	8.0 µm		
Pore density per cm ²	1 x 10 ⁸	1 x 10 ⁵		
Growth area [cm ²]	1.4	1.4		
Insert height [mm]	11	11		
Type	single blister	multi-pack	single blister	multi-pack
Pack of	48 pieces	4 x 9 pieces	48 pieces	4 x 9 pieces
Cat. No.	782720	782721	782726	782727



6-well Insert 2in1 PC membrane

Pore size	0.4 µm	8.0 µm		
Pore density per cm ²	1 x 10 ⁸	1 x 10 ⁵		
Growth area [cm ²]	4.8	4.8		
Insert height [mm]	11	11		
Type	single blister	multi-pack	single blister	multi-pack
Pack of	24 pieces	4 x 6 pieces	24 pieces	4 x 6 pieces
Cat. No.	782740	782741	782746	782747



Technical information & Ordering data

BRAND Insert 2in1 Multi-pack

- Quickly, conveniently open an entire pack
- Remove 3 inserts at one time
- Reduces packaging waste



Multi-pack



24-well Insert 2in1 PET membrane

Pore size	0.4 μm		1.0 μm		3.0 μm		8.0 μm	
Pore density per cm^2	2 x 10 ⁶		2 x 10 ⁶		2 x 10 ⁶		2 x 10 ⁵	
Growth area [cm^2]	0.6		0.6		0.6		0.6	
Insert height [mm]	10		10		10		10	
Type	single bl.	multi-pack	single bl.	multi-pack	single bl.	multi-pack	single bl.	multi-pack
Pack of	48 pieces	4 x 12 pc.	48 pieces	4 x 12 pc.	48 pieces	4 x 12 pc.	48 pieces	4 x 12 pc.
Cat. No.	782710	782711	782712	782713	782714	782715	782716	782717



12-well Insert 2in1 PET membrane

Pore size	0.4 μm		1.0 μm		3.0 μm		8.0 μm	
Pore density per cm^2	2 x 10 ⁶		2 x 10 ⁶		2 x 10 ⁶		2 x 10 ⁵	
Growth area [cm^2]	1.4		1.4		1.4		1.4	
Insert height [mm]	11		11		11		11	
Type	single bl.	multi-pack	single bl.	multi-pack	single bl.	multi-pack	single bl.	multi-pack
Pack of	48 pieces	4 x 9 pc.	48 pieces	4 x 9 pc.	48 pieces	4 x 9 pc.	48 pieces	4 x 9 pc.
Cat. No.	782730	782731	782732	782733	782734	782735	782736	782737



6-well Insert 2in1 PET membrane

Pore size	0.4 μm		1.0 μm		3.0 μm		8.0 μm	
Pore density per cm^2	2 x 10 ⁶		2 x 10 ⁶		2 x 10 ⁶		2 x 10 ⁵	
Growth area [cm^2]	4.8		4.8		4.8		4.8	
Insert height [mm]	11		11		11		11	
Type	single bl.	multi-pack	single bl.	multi-pack	single bl.	multi-pack	single bl.	multi-pack
Pack of	24 pieces	4 x 6 pc.	24 pieces	4 x 6 pc.	24 pieces	4 x 6 pc.	24 pieces	4 x 6 pc.
Cat. No.	782750	782751	782752	782753	782754	782755	782756	782757

Application Note

BRAND® Insert 2in1 supports the cultivation of Reconstructed Human Epidermis (RhE) used for skin corrosion tests (OECD TG 431)

Author: BRAND GMBH + CO KG



Introduction

Reconstructed Human Epidermis (RhE) is used as an alternative in vitro test system partially able to replace tests on laboratory animals and provide data that may be more predictive for humans when compared to animal testing. For these reasons 3D tissue models become more and more attractive not only for research but also in the context of regulatory hazard identification of irritant and corrosive chemicals (OECD TG 431*). However, to be used for regulatory decision making, a validated RhE must meet certain quality criteria to reliably distinguish the different hazard potentials of chemicals.

Here we show that human derived keratinocytes cultivated in the BRAND Insert 2in1 differentiate into RhE models using the standard cultivation procedure including a submerged and air-liquid interphase condition. The RhE reproducibly determines the corrosive potential of the categorized chemicals.

* OECD Test Guideline for testing chemicals 431: In vitro skin corrosion: reconstructed human epidermis (RHE) test method; 2015

Methods

Cell culture

Reconstructed human Epidermis was generated using normal human keratinocytes seeded in BRAND Insert 2in1 or cell culture inserts from another manufacturer in a density of 2×10^5 cells/cm² (125.000 cells in 200 µl per insert). For submerged and air-liquid interphase (ALI) cultures both insert types were placed standing on the bottom of culture plates. BRAND Inserts featured a plasma-treated (cellGrade™ plus) polycarbonate membrane with a pore size of 0.4 µm and a culture area of approximately 0.6 cm². After submerged cultivation ALI-culture was initiated to induce keratinocyte differentiation into the multilayered epidermal model and finally exposed to chemicals.

MTT assay and test substance application was performed according to the SOP for epiCS® In Vitro Skin Corrosion (CellSystems®).

Test substances

For each exposure time and chemical 3 RhE models were used for in vitro skin corrosion testing. The test chemicals applied were phosphate buffered saline (PBS) (negative control), 8N KOH (positive control), 4-(Methylthio)-benzaldehyde, lactic acid and formic acid. RhE mean viability was determined for each test chemical after 3 and 60 min of exposure and normalized to the mean viability of negative controls at the corresponding time point.

Results

Morphology

The RhE models were fixed with Bouin's Solution and subsequently cryo-embedded. Following cross sections of the RhE samples were stained with hematoxylin and eosin and subjected to histological imaging. The RhE models show the typical layers of native skin with a multilayered corneal layer (stratum corneum).

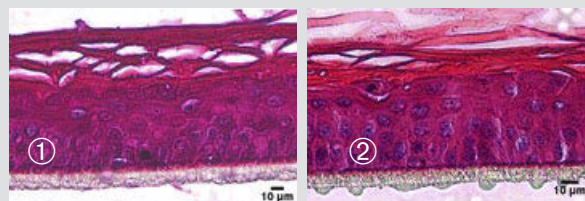

Figure 1: Hematoxylin/eosin staining of RhE models cultivated in the cell culture Insert 2in1 (1) and in an insert from another manufacturer (2). Human derived keratinocytes develop a stratified epidermis with a multilayered stratum corneum.

Barrier function test (EC50)

To determine whether the stratum corneum of RhE models cultured in different inserts developed a proper barrier function cultures were exposed to PBS and the benchmark chemical Triton X-100 for 60 min. After the exposure, RhE models were incubated in presence of MTT vital dye. Quantification of the metabolic activity was determined by measuring the optical density of the reduced MTT-dye at 570 nm wave length. Data indicates a distinct barrier function of the stratum corneum as the mean viability of the cultures was not reduced by more than 50 % at the given exposure time.

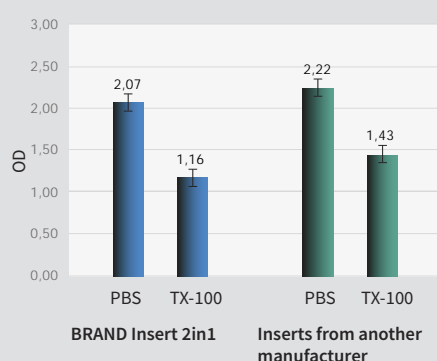

Figure 2: Viability of RhE exposed to PBS or Triton X-100 (TX-100). Data shows the optical density at 570 nm (OD) of isopropanol extracted formazan from tissue cultures.

Conclusion

BRAND Inserts 2in1 are equally suitable to produce RhE as inserts from other manufacturers. This was shown by the comparison of H&E stained histological slides with the multilayered stratified epidermis (fig.1) and the integrative growth of the keratinocytes with a functional barrier function was demonstrated by EC₅₀ data (fig. 2).

Using proven chemicals for the OECD corrosion test with RhE, we could measure data comparable with inserts of another manufacturer. The BRAND Insert 2in1 is a promising tool for use in corrosion tests and a step forward to avoid animal testing and gather data much more transferable to humans than animal testing ever will be.

In vitro corrosion test

First, MTT assay derived viability of RhE models was determined for 3 and 60 minutes using PBS. Measurements show that the viability of RhE models within the two insert types is comparable. However, tissue cultures from the BRAND insert 2in1 generated data with reduced standard deviations at 3 and 60 min of PBS exposure when compared to tissue culture grown in the competitor insert (table 1).

To test whether the RhE models cultivated in BRAND insert 2in1 can also be used to distinguish the corrosive potential of chemicals, RhE models were exposed to a set of classified substances. In parallel, the same chemicals were applied to RhE models cultivated in the insert from another manufacturer used in chemical hazard identification context before. The mean viability of treated RhE models was normalized to viability data of the negative control (NC).

OD negative control			
BRAND Insert 2in1		Other manufacturer	
3 min	60 min	3 min	60 min
2.92	2.21	2.76	2.38
2.95	2.22	2.82	2.45
2.96	2.44	2.48	1.79
2.94	2.45	2.47	1.75
2.96	2.52	2.08	2.23
2.99	2.51	2.06	2.13
Standard deviation OD			
0.02	0.16	0.36	0.32

Table 1: OD measurement of formazan-isopropanol extracted from RhE models exposed to PBS (NC). For each condition 6 tissues were tested. Measurements were performed in transparent flat bottom microplates using a microplate spectrophotometer at 540 -570 nm

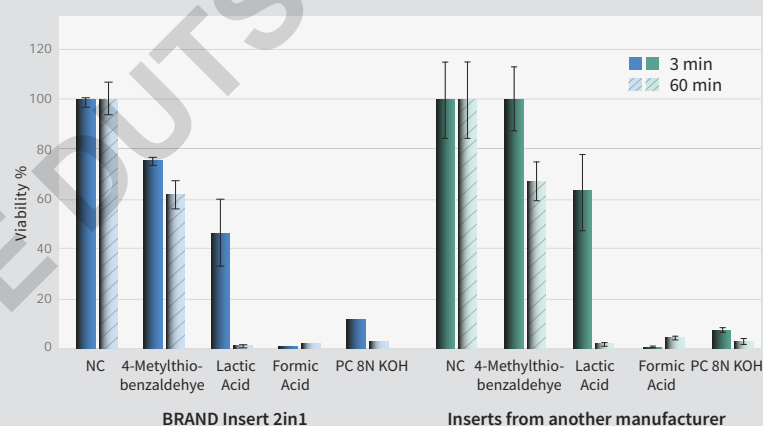

Figure 3: Comparison of corrosive potential of different chemicals. NC, negative control; PC, positive control. Data show mean viability of 3 RhE per condition with standard deviation. Viability was determined by MTT assay. Optical density of isopropanol extracted formazan was measured in microplate spectrophotometer at 540 -570 nm.

The presented data show that the BRAND Insert 2in1 with PC membrane and a pore size of 0.4 μm supports the differentiation of normal human keratinocytes to a stratified epidermis model. Tissue models from the two inserts predicted 4-(Methylthio)-benzaldehyde as non corrosive chemical because viability is not reduced by 50 % after 3 min and 60 min of exposure when compared to NC. Formic acid is predicted to be corrosive because viability of tissue models from both inserts is reduced by more than 50% and more than 85% after exposure for 3 min and 60 min, respectively. Lactic acid is a corrosive substance of subcategory 1B/1C, which is shown by a viability higher than 50 % after 3 min and lower than 15 % after 60 min exposure, respectively. The not significant difference to the 50 % threshold within the 3 min exposure with the BRAND insert may be due to the small number of measurements.

Accessories

Lids

Cover mats

Sealing films



Lids for 96-well standard plates

For BRANDplates® microplates Cat. No.:

781600-08, 781660-68, 781720-29, 781780-82, 781840-42, 781900-02, 781960-68, 782022-28, 782082



Condensation rings	Height	Sterile	Pack of	Cat. No.
yes	8 mm	-	100 pieces (20 bags of 5 lids)	782150
no	8 mm	-	100 pieces (20 bags of 5 lids)	782151



Lids for black and white 96-well plates with transparent bottom

For BRANDplates® microplates Cat. No.:

781610-11, 781670-71, 781731, 781910-11, 781970-75, 782030-35, 782090-95



Condensation rings	Height	Sterile	Pack of	Cat. No.
yes	9 mm	-	100 pieces (20 bags of 5 lids)	782155



Lids for all 384-well plates

For BRANDplates® microplates Cat. No.:

781620-27, 781680-87, 781740-42, 781980-89

Condensation rings	Height	Sterile	Pack of	Cat. No.
no	4.5 mm	-	50 pieces (5 bags of 10 lids)	782152

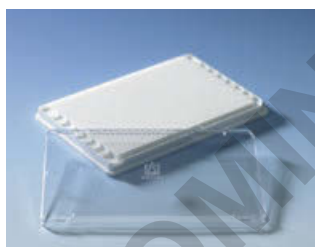

Lids for all 1536-well plates

For BRANDplates® microplates Cat. No.:

781640-42, 781700-02, 782000-02

Condensation rings	Height	Sterile	Pack of	Cat. No.
no	5.5 mm	-	50 pieces (5 bags of 10 lids)	782153



Cover mats

Cover mats reduce the maximum volume of wells.

Adhesive sealing films and polystyrene lids can also be used.

Description	Material	Pack of	Cat. No.
for 0.3 ml 384-well plates	Silicone	50 pieces	701357

Sealing films, self-adhesive

Automation

Easy to pierce with pipette tips.
Temperature range -40 °C to +90 °C. Single films.



PE top, underside PP with adhesive. Inert, chemically resistant.
Packs of 50 sheets.

Cat. No. 701370



Vinyl, acrylic adhesive.
Repeatably pierceable with pipette tips.
Packs of 100 sheets.

Cat. No. 701374

Fluorescence and luminescence measurement

Temperature range -40 °C +80 °C.
Single films.

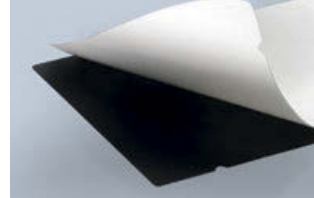

For fluorescence measurement
Vinyl, black.
Light-absorbent.
Packs of 50 sheets.

Cat. No. 701371



For luminescence measurement
Vinyl, white.
Reflective.
Packs of 50 sheets.

Cat. No. 701372

Cell and tissue culture

Rayon. Gas-permeable. Temperature range -20 °C to +80 °C.
Single films.

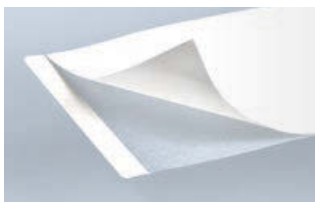

Non-sterile
pack of 100 sheets

Cat. No. 701364

Sterile
pack of 50 sheets

Cat. No. 701365

More sealing films,
see chapter II, page 121.



Comparison of sealing options for BRANDplates® microplates

	Evaporation protection	Transparency	Handling	Price
BRANDplates® lid	+	++	+++	+++
Self-adhesive sealing film	++	++	++	++
Pressure sensitive sealing film	+++	+++	+++	+
Gas-permeable sealing film	+	-	++	++
Sealing film for automation	+	-	++	++
Vinyl sealing film (black and white)	++	-	++	++



PCR & qPCR

The Polymerase Chain Reaction (PCR) is an enzyme-based process for duplicating DNA in vitro. PCR is considered a standard method in almost all life science laboratories. The process is used in a wide variety of applications, such as DNA cloning, diagnosing genetic disorders or infectious diseases, functional gene analysis, paternity tests, and forensic analysis.

PCR is becoming increasingly important as our society ages, chronic illness increases, personalized medicine develops and as our understanding of disease diagnoses grows.

Because of this, new and even more sensitive versions are being developed all the time. Quantitative PCR (qPCR) which provides insight into the amount of amplified DNA is quickly gaining favor. BRAND offers cleanroom quality PCR consumables for sophisticated PCR and qPCR applications where quality and purity are key. Live monitoring of our validated, ISO class 8 cleanroom and a high degree of automation ensure the purity of PCR products from BRAND. Independent test laboratories accredited in accordance with ISO 17 025 inspect our PCR products for the absence of DNA, DNase, RNase and endotoxins/pyrogens.



Chapter II

PCR & qPCR work areas

Sample preparation

PCR testing

Assaying and sample storage



5.1 Microtubes
page 89



6.1 Single PCR tubes
page 94



6.2 PCR strips
page 97

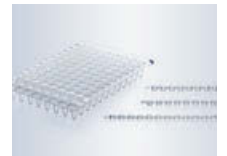

8.1 PCR cap strips
page 118



7.1 24-well | 48-well plates
page 102



7.2 96-well plates
page 104



7.3 Rigid frame 96-well
plates page 109



8.2 Sealing films
page 121

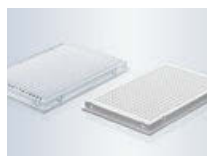

7.4 384-well plate
page 112

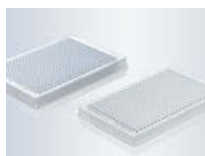

7.5 Rigid Frame 384-well
plate page 114



5. Sample preparation

PCR offers outstanding flexibility and variability. In addition to different PCR versions, users can individually select their primers and polymerase. DNA or RNA serves as the starting material for the PCR. There are many different options for the isolation of DNA/RNA from the available samples. Precise test planning, clean DNA/RNA isolation, and correct preparation and creation of the master mix, are essential for a successful PCR.

In addition to the purity and high quality of the consumable materials used, how materials are handled also plays an important role. The PCR reagents used are expensive and must always be properly stored and protected while work is being carried out.

BRAND offers a wide variety of PCR-suitable microtubes with cleanliness suitable for reliable and fast sample preparation. Cleanroom production and strict quality controls ensure appropriate security and reliability.

5.1 PCR-suitable microtubes



- ✓ Lid membrane highly transparent and easy to pierce
- ✓ Tight-sealing, easy to open cap
- ✓ High-purity polypropylene free from PCR inhibitors

DNA isolation and preparation of the master mix are essential for a successful PCR, require the highest possible product cleanliness, good impermeability, and the option for use in high throughput analysis.

The quality level BIO-CERT® PCR QUALITY ensures the required cleanliness for PCR-setups, storage of PCR samples and other applications with high cleanliness requirements.

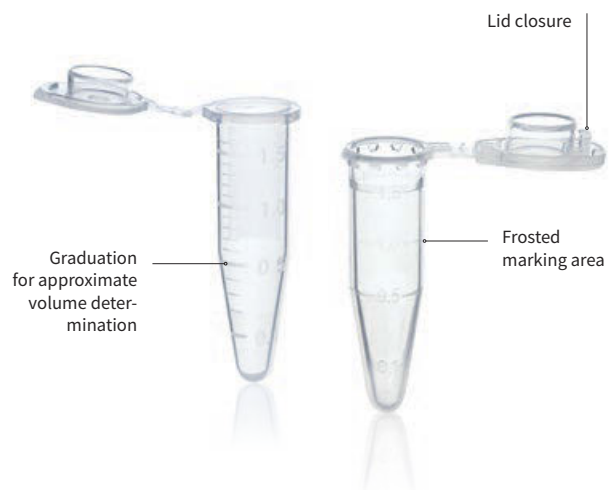

Applications

- + DNA and RNA isolation
- + DNA and RNA purification
- + Preparing a master mix
- + Sample dilution

Features

- + Made of pure polypropylene
- + Tight-sealing cap
- + In sizes 0.5 ml, 1.5 ml, 2 ml and 5 ml
- + Highly transparent and consistent wall thickness

User information

- When incubating at high temperatures, we recommend using microtubes with lid closure in order to prevent the vessels from bursting open.
- Microtubes with lid closure can be centrifuged up to 30,000 x g.

Caution: The relative centrifugal force (RCF) is dependent on the radius of the rotor and the speed (RPM) of the centrifuge!

General conversion formula:

$$g = RCF = ((U/min)/1000)^2 \cdot r \cdot 1.118$$

g-force	Gravitational acceleration
RCF:	Relative centrifugal force (corresponds to the g-force)
r:	Rotation radius
U/min:	Rotor revolutions per minute (speed)

We advise against autoclaving microtubes. Autoclaving can be a source of contamination for disposable products.

Advantages of PP

- **High resistance to chemicals:** microtubes can be used with DMSO and other aggressive chemicals.
- **Good temperature resistance:** Containers remain stable even at high temperatures; these products are generally autoclavable at 121 °C (2 bar), acc. DIN EN 285.
- **Minimal retention:** PCR tubes, microtubes and tips have no residual wetting and the material is biologically inert – no adhesion of biomolecules to the surfaces.

The microtubes are not recommended for long-term storage of samples. We recommend using microtubes with screw cap (chapter III) or cryogenic tubes (chapter I).

Accessories

Microtube rack, PP

Numbered positions for 20 microtubes, 1.5 ml. Autoclavable at 121 °C (2 bar), acc. DIN EN 285. Pack of 1.

Cat. No. 7806 05



Mini cooler, PC

Durable polycarbonate filled with non-toxic gel. Mini coolers hold twelve 0.5 ml to 2.0 ml tubes. Pack of 1.



Bench temp. maintained	Time held	Color	Cat. No.
0 °C	60 min.	red	114930
-20 °C	60 min.	yellow	114935
-70 °C	45 min.	white	114940

Ordering information for BRAND liquid handling equipment is provided at shop.brand.de



Microtube rack, PP

Stackable racks with alpha-numeric positions. Operating temperature -20 °C to +90 °C. Autoclavable at 121 °C (2 bar), acc. DIN EN 285. Density 1.2 g/cm³. Will not float in waterbath. Pack of 5.



For Ø up to mm	Positions	white Cat. No.	blue Cat. No.	red Cat. No.
11	8 x 16	4341050	4341051	4341052
13	6 x 14	4341000	4341001	4341002

Technical information & Ordering data

Microtubes with snap lid

- High cleanliness for demanding applications
- Tight sealing snap lid
- Can be opened and closed with one hand

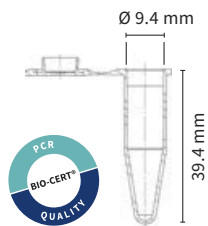

1.5 ml microtubes with snap lid



Color	transparent	yellow	blue	green	orange	amber
Outer-Ø [mm]	10.7	10.7	10.7	10.7	10.7	10.7
RCF max. (at 20 °C, t 20 min)	20,000	20,000	20,000	20,000	20,000	20,000
Pack of	500 pieces	500 pieces	500 pieces	500 pieces	500 pieces	500 pieces
Cat. No.	780420	780421	780422	780423	780424	780425



Information on the different quality levels is provided on page 5.

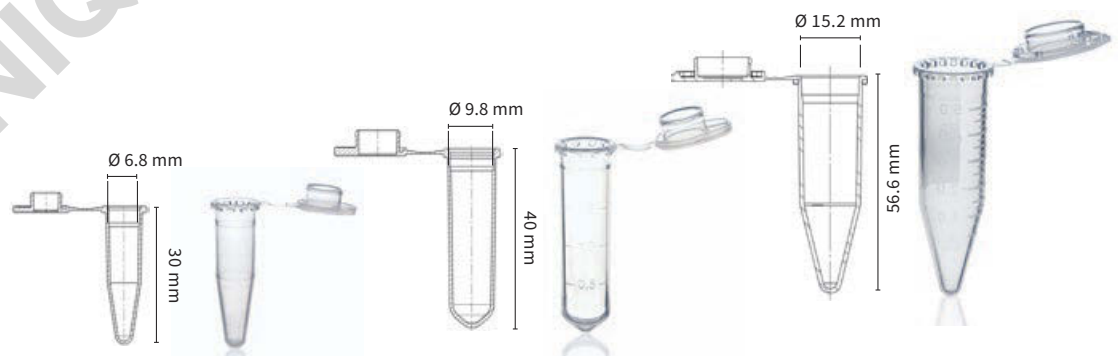

Microtubes with snap lid

Volume	0.5 ml	2.0 ml	5.0 ml
Lid membr. thickness [mm]	0.3	0.3	0.3
Outer-Ø [mm]	7.9	10.7	16.6
Height with closed lid [mm]	31.4	41.15	59
RCF max. (at 20 °C, t 20 min)	10,000	20,000	25,000
Pack of	500 pieces	500 pieces	250 pieces
Cat. No.	780507	780550	780555

Microtubes with lid closure

- Enhanced lid closure protects against accidental opening while heating samples
- High transparency for optimum visual control
- Can be centrifuged up to 30,000 x g

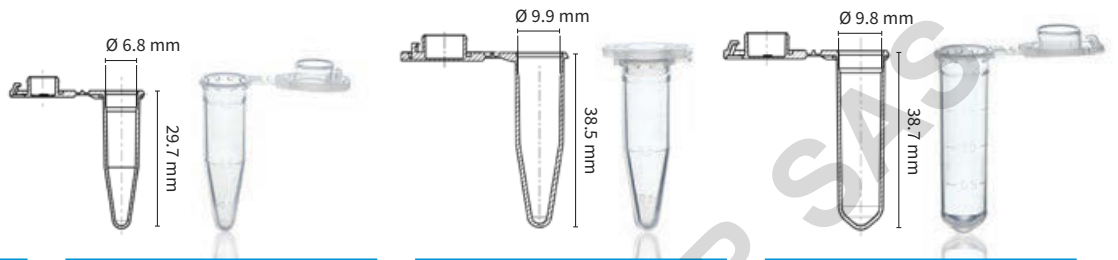

Microtubes with lid closure

Volumen	0.5 ml	1.5 ml	2.0 ml
Lid membrane thickness [mm]	0.3	0.4	0.45
Outer-Ø [mm]	10.0	12.8	12.8
Height with closed lid [mm]	30.0	38.8	40.0
RCF max. (at 20 °C, t 20 min)	30,000	30,000	20,000
Pack of	500 pieces	1000 pieces	500 pieces
Cat. No.	780536	780540	780546

The lid closure protects against accidentally opening the cap



The wide lip on the cap allows for one-handed handling





6. PCR tubes for small and medium sample throughput

When establishing a PCR, users must select the right primer, reagents, optimal annealing temperatures, and the ideal duration for each PCR step.

The optimal method is important to ensure the PCR reaction is stable and that no complications occur later in the routine process. A large number of preliminary tests are required to check the influence of different parameters on the individual PCR.

BRAND offers a broad spectrum of single PCR tubes and PCR strips. Our product range allows users to optimize their methods and work economically, even with a small number of samples. Users can also process samples in parallel without accidental mix-ups thanks to the different color options.

6.1 Single PCR tubes



- ✓ Thin walls for rapid heat transfer
- ✓ Tightly closing covers protect samples against evaporation
- ✓ Colors available for easy identification of samples

Single PCR tubes from BRAND with volumes of 0.2 and 0.5 ml are the efficient solution for small and medium sample throughput. The extra thin-walled tubes ensure optimum heat transfer during PCR for shorter cycle times over a wide range of temperatures. To prevent sample losses from heating, the caps reliably seal the vessels with their tight fit. This ensures quality and repeatable results even with small sample volumes. At the same time, the caps can be opened and closed with ease. Tubes are available in several colors, allowing easy visual sample tracking.

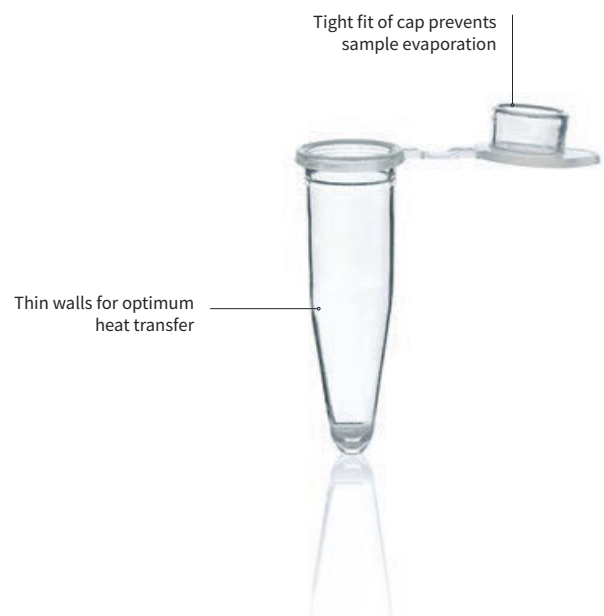

Applications

- + Tests with small sample sizes
- + Testing different primer variants
- + Establishing a method
- + Inspecting reagents

Features

- + Made of pure polypropylene
- + Tight-sealing cap
- + In sizes 0.2 and 0.5 ml and colors transparent, rose, yellow, green and blue
- + Suitable for all standard thermal cyclers

User information

If the PCR tubes become deformed, check whether the closing pressure for the thermocycler lid is too great or whether it is distributed unevenly over the PCR tube: Most cyclers manufacturers recommend placing empty tubes with the same type of cap (domed or flat) into the corners of the thermoblocks as “buffers,” in order to distribute the force over multiple tubes when there is only a small numbers of samples.

We advise against autoclaving PCR products. Autoclaving can be a source of contamination for disposable products.



In addition to setting up PCR reactions, tubes are suitable for:

- setting up a restriction digest or ligation
- aliquoting and short-term storage between 4 °C and 25 °C

PCR tubes should not be used:

- to store samples for an indefinite period of time
- to store samples and aliquots down to -20 °C

q!PCR products from BRAND

PCR tubes:

Tubes with highly transparent caps for sensitive detection of fluorescence signals

PCR plates:

Plates that fit in quantitative Real-Time thermal cyclers, also available in white

PCR seals:

Seals, highly transparent for sensitive detection of fluorescence signals

Accessories

Ordering information for BRAND liquid handling equipment is available at shop.brand.de



Mini cooler, PC

Mini coolers are designed to protect a wide range of solutions (enzymes, DNA, RNA, cell suspensions) by helping to maintain freezer temperatures on the lab bench. Durable polycarbonate filled with non-toxic gel. Mini coolers hold twelve 0.5 ml to 2.0 ml tubes. Pack of 1.



Bench temp. maintained	Time held	Color	Cat. No.
0 °C	60 min.	red	114930
-20 °C	60 min.	yellow	114935
-70 °C	45 min.	white	114940

PCR box/rack, PP

Assorted colors (red, yellow, green, purple, blue). Suitable for sample preparation, for keeping and storing 0.2 ml single tubes, 8-strips, and 12-strips, and 96-well PCR plates. These racks can also be stacked without lids. Withstand temperatures from -80 to +121 °C. Pack of 5.



Cat. No. 781362

Mini cooler PCR, PP

With transparent lid. For protecting samples from warming. The mini PCR cooler keeps samples at 4 °C for approximately 3 hours. The insulating gel changes from violet to pink at 7 °C. Suitable for 0.2 ml single tubes, 8-strips, and 12-strips, as well as 96-well PCR plates. Pack of 2.



Cat. No. 781260

Technical information & Ordering data

Single PCR tubes with flat or domed cap

- Perfect cap seal to protect against evaporation
- Easy to open and close
- Various colors allow fast sample identification
- Fits all commonly used thermocyclers with a heated lid



0.2 ml PCR tube with attached domed cap

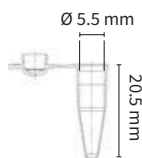

Color	transparent
Inner Ø [mm]	5.5
Height [mm]	20.5
Pack of	1000 pieces (1 bag)
Cat. No.	781300

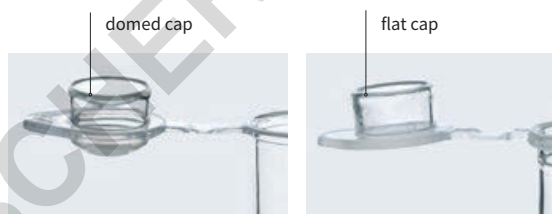

0.2 ml PCR tube with attached flat cap

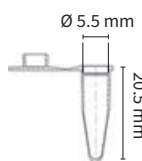

Color	transparent	rose	yellow	green	blue
Inner Ø [mm]	5.5	5.5	5.5	5.5	5.5
Height [mm]	20.5	20.5	20.5	20.5	20.5
Pack of	1000 pieces (2 bags of 500)	1000 pieces (2 bags of 500)	1000 pieces (2 bags of 500)	1000 pieces (2 bags of 500)	1000 pieces (2 bags of 500)
Cat. No.	781305	781301	781302	781303	781304



0.5 ml PCR tube with attached flat cap

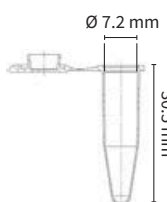

Color	transparent	rose	yellow	green	blue
Inner Ø [mm]	7.2	7.2	7.2	7.2	7.2
Height [mm]	30.5	30.5	30.5	30.5	30.5
Pack of	1000 pieces (2 bags of 500)	1000 pieces (2 bags of 500)	1000 pieces (2 bags of 500)	1000 pieces (2 bags of 500)	1000 pieces (2 bags of 500)
Cat. No.	781310	781311	781312	781313	781314

6.2 PCR strips



- ✓ High flexibility with a wide range of cap types and film strips
- ✓ Reduced evaporation losses thanks to tightly closing cap strips
- ✓ Rapid heat transfer through thin vessel walls

PCR 8- and 12-tube strips offer a flexible solution for your PCR or qPCR with medium sample volumes. The choice is yours: domed caps for extra sealing pressure via the lid of the thermal cycler, or flat caps required for qPCR. Attached cap strips can be easily opened and closed with one hand, while separate cap and film strips are especially suitable for automation, as they will not obstruct robotics.

All variants seal the vessels reliably, effectively protecting your samples from evaporation and contamination. BRAND's cleanroom quality ensures that the strips meet all the criteria of the quality level BIO-CERT® PCR QUALITY by producing them under controlled cleanroom conditions. This ensures reliable and reproducible results.

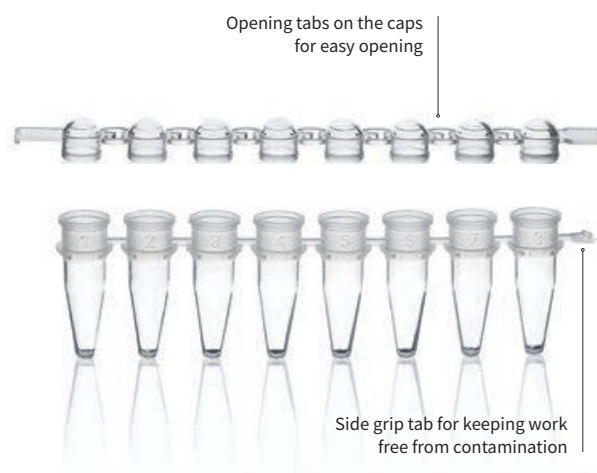

Applications

- + Tests using small sample sizes
- + Routine applications with triple repetition and appropriate negative controls
- + Single real-time tests

Features

- + Made of pure polypropylene with flat or domed caps
- + Available in low or standard profiles
- + Available in various colors for sample identification or white for optimized qPCR
- + Strips with three connectors for increased rigidity

User information

- PCR strips with a connector offer good flexibility. The strips can be cut easily using scissors or by twisting them for individual adjustment.
- For applications using strips with increased rigidity, we recommend using tubes with three braces. These cannot be easily divided, but offer maximum security thanks to improved stability.
- Side grip tabs and attachments on the individual caps allow for easy opening and contamination-free handling.
- Strips with attached individual lids offer improved protection against contamination and reduce the danger of mix-ups.

We advise against autoclaving PCR products. Autoclaving can be a source of contamination for disposable products.

White PCR products by BRAND yield significantly better results in qPCR than transparent vessels. In combination with the smooth surfaces, the white color ensures optimal reflexion of the fluorescence signals.

Accessories

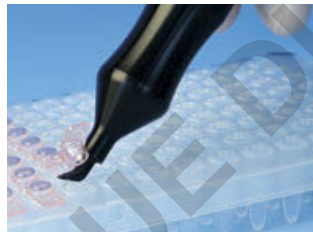

Cap Tool

For reliable sealing and opening of cover caps. Handy and lightweight material for fatigue-free operation. Pack of 1.

Cat. No.

781419



Ordering information for BRAND liquid handling equipment is available at shop.brand.de



PCR box/rack, PP

Assorted colors (red, yellow, green, purple, blue). Suitable for sample preparation, for keeping and storing 0.2 ml single tubes, 8-strips, and 12-strips, and 96-well PCR plates. These racks can also be stacked without lids. Withstand temperatures from -80 to +121 °C. Pack of 5.

Cat. No.

781362



Mini cooler PCR, PP

With transparent lid. For protecting samples from warming. The mini PCR cooler keeps samples at 4 °C for approximately 3 hours. The insulating gel changes from violet to pink at 7 °C. Suitable for 0.2 ml single tubes, 8-strips, and 12-strips, as well as 96-well PCR plates. Pack of 2.

Cat. No.

781260



Technical information & Ordering data

PCR strips with detached cap strips

- Domed or flat cap strips for a perfect seal
- Contamination-free opening with grip tabs on the end and side of each cap
- Numbered wells for clear identification

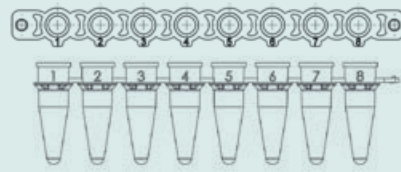

PCR 8-tube strips



Color	transparent	rose	yellow	green	blue	white
Volume [ml]	0.2	0.2	0.2	0.2	0.2	0.2
Pack of	125 pieces	125 pieces	125 pieces	125 pieces	125 pieces	125 pieces
Cat. No.	781320	781321	781322	781323	781324	781325



PCR 8-cap strips



Color	transparent	rose	yellow	green	blue	transparent
Cap	domed	domed	domed	domed	domed	flat
Pack of	125 pieces	125 pieces	125 pieces	125 pieces	125 pieces	125 pieces
Cat. No.	781340	781341	781342	781343	781344	781334



Large pack: PCR 8-tube strips and detached 8-cap strips

Color	transparent	transparent
Volume [ml]	0.2	0.2
Cap	domed	flat
Pack of	250 pieces each (8-tube strips and 8-cap strips)	250 pieces each (8-tube strips and 8-cap strips)
Cat. No.	781327	781326



PCR 12-tube strips

Color	transparent
Volume [ml]	0.2
Pack of	80 pieces
Cat. No.	781280

PCR 12-cap strips

Color	transparent
Cap	domed
Pack of	80 pieces
Cat. No.	781290

PCR strips with attached cap strips

- Attached cap strips with domed caps for one-handed operation
- Contamination-free opening thanks to grip tab on the end
- Thin-walled wells for good temperature transmission

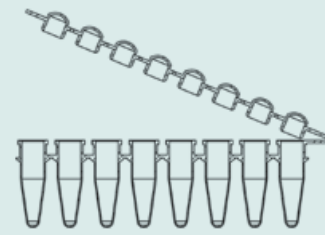

PCR 8-tube strips with attached cap strips

Color	transparent
Volume [ml]	0.2
Cap	domed
Pack of	125 pieces
Cat. No.	781330



Information on the different quality levels is provided on page 5.

PCR strips with attached, flat individual caps

- Highly transparent, flat caps for qPCR applications
- Easy to separate 8-piece strips with 1 connector for maximum flexibility
- Highly stable 8-piece strips with 3 connectors for extremely secure handling
- Standard profile and low profile for reduced volumes



PCR 8-tube strips with single connector

Profile	standard	low profile
Volume [ml]	0.2	0.15
Color	transparent	transparent
Pack of	120 pieces (10 bags of 12 strips)	120 pieces (10 bags of 12 strips)
Cat. No.	781332	781333

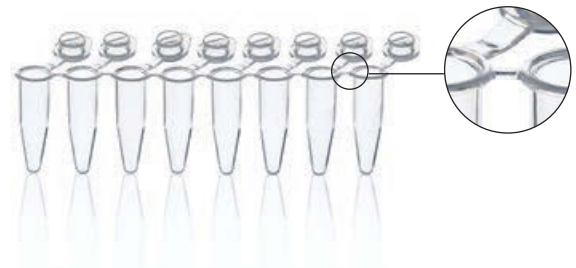

PCR 8-tube strips with three connectors

Profile	standard	standard	low profile	low profile
Volume [ml]	0.2	0.2	0.15	0.15
Color	transparent	white	transparent	white
Pack of	120 pieces (10 bags of 12 strips)	120 pieces (10 bags of 12 strips)	120 pieces (10 bags of 12 strips)	120 pieces (10 bags of 12 strips)
Cat. No.	781315	781316	781318	781317





7. PCR plates for medium and high sample throughput

As new PCR methods become established all the time, the number of different tests completed is also growing. PCR is considered a standard process in many fields. In addition to processes with medium sample throughput, high throughput applications are becoming more and more common in order to save time and costs. Easy and secure handling is essential for managing growing sample quantities. Users are working to optimize processes and reduce the consumption of materials and reagents.

BRAND offers ideal consumable materials for high throughput analysis, thanks to its wide-ranging product portfolio of PCR plates. Extra thin walls, smooth surfaces to avoid sample loss due to interaction with the material, and different colors and shapes are ideal for use in a broad spectrum of applications and equipment. Their standardized ANSI/SLAS format allows them to be used in all commonly available cyclers.

7.1 24-well | 48-well PCR plates



- ✓ Compact format fits all common thermal cyclers
- ✓ Raised well edges protect against cross-contamination
- ✓ Rapid heat transfer through thin vessel walls

With 24- and 48-well PCR plates, you can handle medium sample volumes with ease. The compact format works with all common thermal cyclers and provides easy handling compared to strips or single tubes.

To avoid cross-contamination from well to well, the edges of the wells are slightly raised so that you always obtain reliable results. Thin vessel walls ensure rapid temperature transfer for short cycle times.

The cleanroom quality and the quality level BIO-CERT® PCR QUALITY of PCR consumables from BRAND guarantee reliable results.

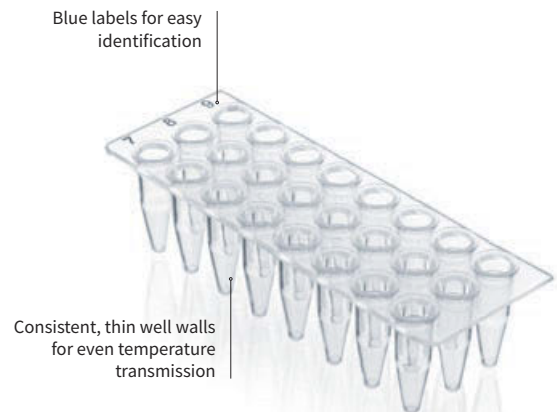

Applications

- + Tests using medium sample sizes
- + Testing different primer variants
- + Small sample throughput with a large number of repetitions

Features

- + Made of pure polypropylene
- + Extra-thin walls for fast temperature transmission
- + Tight sealing with cap strips and film strips
- + Compatible with all commonly available cyclers
- + For use with multichannel pipettes

User information

- The plates allow for work even with small sample throughput thanks to their compact design. This provides the perfect balance between efficiency and ease of handling.
- Unique alphanumeric codes prevent mix-ups.
- The plates can be sealed using cap strips or sealing film strips. Closing individual rows reduces the risk of mix-ups and contamination.
- To ensure an optimal plate format with a small number of samples, non-skirted PCR plates can be cut using regular scissors.



We advise against autoclaving PCR products. Autoclaving can be a source of contamination for disposable products.

Technical information & Ordering data

24-well and 48-well plates, non-skirted

- Compact standard format fits all commonly used thermocyclers with a heated lid
- Rapid heat transfer through thin vessel walls
- Easy to seal with 8-cap strips or sealing film strips

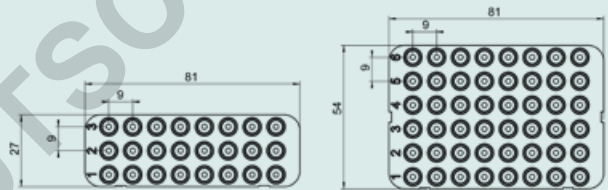

24-well, non-skirted, standard profile

Type	standard	standard
Well rim	not elevated	not elevated
Color	transparent	white
Volume [ml]	0.2	0.2
Pack of	40 pieces (5 plates per bag)	40 pieces (5 plates per bag)
Cat. No.	781411	781412



48-well, non-skirted, standard profile

Type	standard	standard
Well rim	not elevated	not elevated
Color	transparent	white
Volume [ml]	0.2	0.2
Pack of	40 pieces (5 plates per bag)	40 pieces (5 plates per bag)
Cat. No.	781415	781416



7.2 96-well PCR plates



- ✓ Rapid heat transfer through thin vessel walls
- ✓ Suitable for all standard thermal cyclers
- ✓ Tightly sealable to protect against evaporation and contamination

For medium and high sample throughput, 96-well plates from BRAND are the efficient solution for PCR and qPCR, and can be conveniently filled using multichannel pipettes or pipetting robots. The uniform and thin wall thicknesses of the wells ensure rapid transfer of the temperature from the cycler to the sample, thus reducing cycle times. A number of skirt choices ensures a good fit in common thermal cyclers for efficient heat transfer. For qPCR, white plates are available that optimally reflect the fluorescence signals.

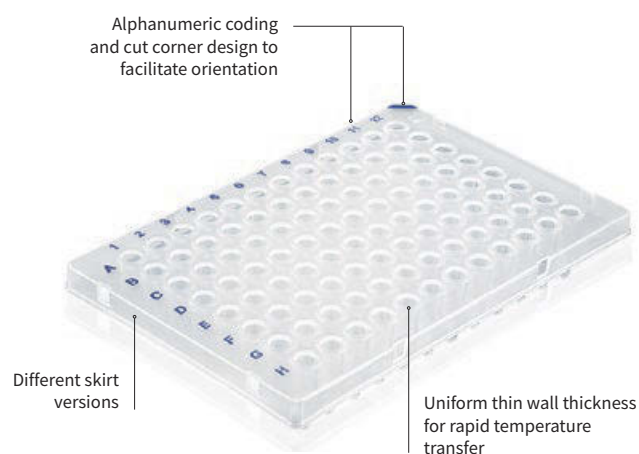

Applications

- + Use for high throughput analyses
- + Use in automated process sequences
- + Method testing with 2D gradient PCR
- + PCR arrays

Features

- + Made of PP in low profile or standard profile
- + Available with different skirt options and in white or transparent
- + Elevated well rim available to prevent well to well contamination
- + Smooth interior surfaces for minimal interactions

User information

- To achieve accurate and consistent results throughout the entire plate, the plates must fit the cycler exactly. The plates must be tightly sealed to prevent evaporation.
- The right profile and skirt version must be selected depending on the cycler used.

Which plate is right for my application?

With the large number of plates and cyclers available on the market, it can be difficult to choose. However, you should primarily choose your plate based on the cycler you are using. The compatibility table provides an overview of tested combinations, which can help you quickly find the right plate for your cycler:



Standard or low profile?

- Standard profile: These tubes fit into most classic thermocyclers, real-time PCR detection systems and sequencers.
- Low profile: The reduced air space above the PCR solution reduces evaporation. This ensures reaction conditions remain more constant during thermocycling than in standard profile tubes, particularly for low volumes of solution ($\geq 20 \mu\text{l}$). At the same time, these tubes also offer advantages in terms of light transmission during fluorescence assays, low volume, and fast PCR applications.

Semi-skirted and skirted PCR plates can be tagged with a barcode:



We advise against autoclaving PCR products. Autoclaving can be a source of contamination for disposable products.

Application Note

Improved sealing surface of PCR plates from BRAND to support reliable evaporation protection

Author: BRAND GMBH + CO KG

The selection of proper material and surface finishing have an important influence on the sealing properties of PCR plates. It's not only important to select quality sealing films, but considering PCR plate design also can improve results for sample recovery during PCR. Design features such as a planar surface, and uniform plate and well thickness are essential for proper sealing and to the minimization of evaporative losses. In addition, the improved adhesion of sealing films support sample preservation. This technical note compares the attachment qualities of the Real-Time PCR sealing film (#781391) with corresponding PCR plates from several manufacturers and having different physical characteristics.

Evaporation losses of different PCR plates during PCR, sealed with adhesive sealing film:

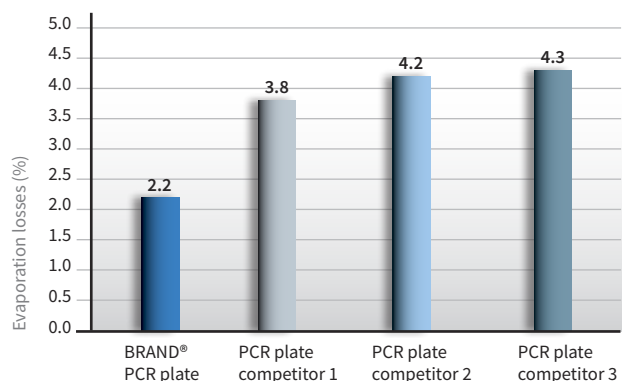

Technical information & Ordering data

96-well plate, non-skirted

- Maximum variability in cyclers selection
- Good plate stability thanks to a reinforced base plate
- Quick sample identification with alphanumeric codes in contrasting colors

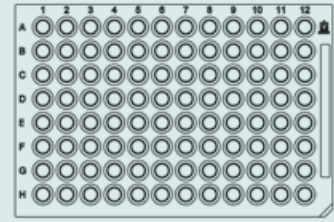

96-well, non-skirted, low profile



Type	low profile	low profile
Well rim	not elevated	not elevated
Color	transparent	white
Volume [ml]	0.15	0.15
Cut corner	A12	A12
Pack of	50 pieces (5 plates per bag)	50 pieces (5 plates per bag)
Cat. No.	781366	781367



96-well, non-skirted, standard profile



Type	standard	standard
Well rim	not elevated	not elevated
Color	transparent	white
Volume [ml]	0.2	0.2
Cut corner	A12	A12
Pack of	50 pieces (5 plates per bag)	50 pieces (5 plates per bag)
Cat. No.	781368	781369



96-well, non-skirted, standard profile, elevated rim



Type	standard	standard
Well rim	elevated	elevated
Color	transparent	white
Volume [ml]	0.2	0.2
Cut corner	H12	H12
Pack of	50 pieces (5 plates per bag)	50 pieces (5 plates per bag)
Cat. No.	781350	781354

Cap strips can also be used for sealing purposes:
781413 (flat)
781414 (domed)



96-well plates, semi-skirted

- Reliable sample identification with colored alphanumeric codes
- Semi-skirted plates are suitable for labeling or applying a bar code
- Optimized surface texture for reliable closure with self-adhesive sealing film

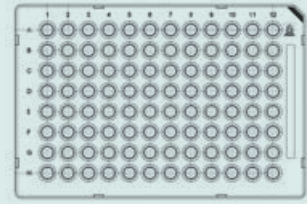

96-well, semi-skirted, low profile



Type	low profile	low profile
Well rim	not elevated	not elevated
Skirt	standard	standard
Color	transparent	white
Volume [ml]	0.15	0.15
Cut corner	A12	A12
Pack of	50 pieces (5 plates per bag)	50 pieces (5 plates per bag)
Cat. No.	781371	781372



Type	low profile	low profile
Well rim	not elevated	not elevated
Skirt	raised	raised
Color	transparent	white
Volume [ml]	0.15	0.15
Cut corner	A1	A1
Pack of	50 pieces (5 plates per bag)	50 pieces (5 plates per bag)
Cat. No.	781373	781374



96-well, semi-skirted, standard profile

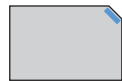

Type	standard	standard
Well rim	not elevated	not elevated
Skirt	standard	standard
Color	transparent	white
Volume [ml]	0.2	0.2
Cut corner	A12	A12
Pack of	50 pieces (5 plates per bag)	50 pieces (5 plates per bag)
Cat. No.	781375	781376



Type	standard	standard
Well rim	elevated	elevated
Skirt	standard	standard
Color	transparent	white
Volume [ml]	0.2	0.2
Cut corner	H12	H12
Pack of	50 pieces (5 plates per bag)	50 pieces (5 plates per bag)
Cat. No.	781400	781357

96-well plates, semi-skirted, for Roche LightCycler 480

- White PCR plate optimized for qPCR use in the Roche LightCycler 480
- Semi-skirted plates are suitable for labeling or applying a bar code

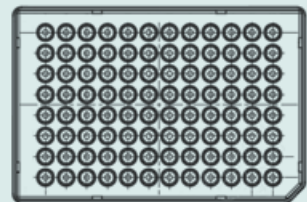

96-well, semi-skirted, low profile



Type	low profile	low profile
Color	white	white
Volume [ml]	0.15	0.15
Cut corner	H12	H12
Pack of	50 pieces (5 plates per bag)	50 pieces + 50 films for qPCR (781391)
Cat. No.	781364	781365



96-well plates, skirted

- Especially rigid for secure handling with robots and automated pipetting systems
- Available with bar code
- Optimized surface texture for reliable closure with self-adhesive sealing film

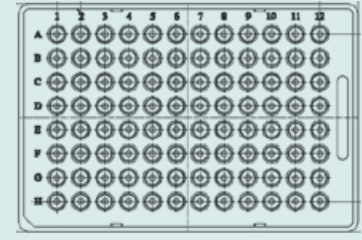

96-well, skirted, low profile



Type	low profile	low profile
Color	transparent	white
Volume [ml]	0.15	0.15
Cut corner	H1	H1
Pack of	50 pieces (10 plates per bag)	50 pieces (10 plates per bag)
Cat. No.	781377	781378



Application Note

Characterisation of antibodies with BRAND PCR plates

Author: AG Arndt/ Krauss
National Center for Tumor Diseases (NCT) Heidelberg
Im Neuenheimer Feld 460
69120 Heidelberg

As long as the laboratory has the correct primers available, colony PCR is a fast and established method to verify the gene of interest (GOI) within a colony-forming clone. Generally, it is sufficient to transfer a minimum number of cells from the colony into the PCR premix. However, these sensitive verification methods can be disrupted by low-quality PCR tubes and contamination by nucleic acids.

The application note “Characterization of antibodies with BRAND PCR plates” describes the use of this technique to identify clones that carry a desired GOI as an insert in the vector. Reactions occurred evenly throughout all of the wells of the BRAND 96-well PCR plate (#781375), allowing for unique identification of positive clones.

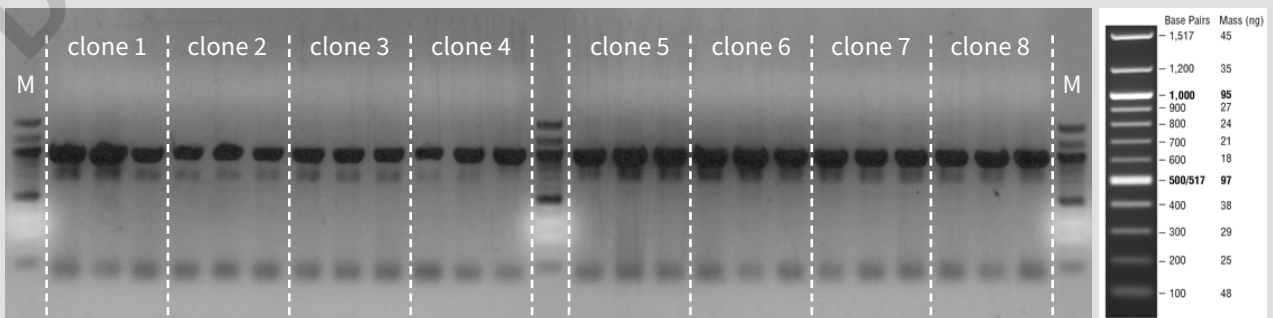

Image: Verification of the approx. 1kb insert in the vector of 8 transformed clones (E.coli).

7.3 Rigid Frame 96-well PCR plates



- ✓ High stability and rigidity of the plate due to the polycarbonate frame
- ✓ Rapid heat transfer through thin vessel walls
- ✓ Suitable for all standard thermal cyclers and fully automation compatible

BRAND offers rigid frame 96-well PCR plates for high sample throughput that requires automated processing. The plates have a strong polycarbonate frame to ensure safe handling in semiautomated and automated pipetting systems and optimal evaporation protection. The rigid frame also allows the use of very thin-walled wells from 100% virgin medical grade polypropylene. The uniform and thin wall thicknesses of the wells ensure rapid transfer of the temperature from the cycler to the sample, thus reducing cycle times.

For qPCR, white plates are available that optimally reflect the fluorescence signals.

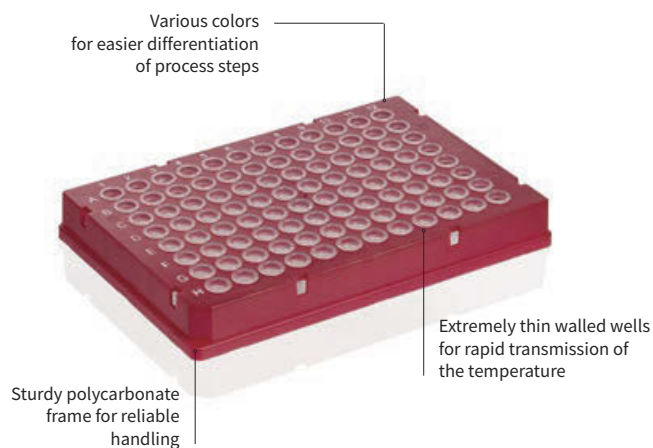

Applications

- + Use for high throughput analyses
- + Use in automated process sequences
- + Method testing with 2D gradient PCR
- + PCR arrays

Features

- + Made of pure PP and PC
- + Low profile or standard profile
- + Sturdy PC frame for reliable handling, available with different skirt options and in white, colored and transparent
- + Smooth interior surfaces for minimal interactions

Technical information & Ordering data

96-well plates, rigid frame, skirted, low profile

- Maximum variability in cyclers selection
- High plate stability thanks to a reinforced PC frame
- Quick sample identification with alphanumeric codes in contrasting colors

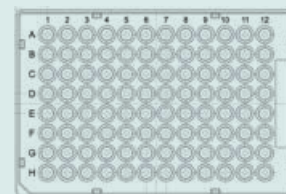

96-well, rigid frame, skirted, low profile



Frame color	frosted	golden	red	green	blue	white
Well color	transparent	transparent	transparent	transparent	transparent	white
Profile	low profile	low profile	low profile	low profile	low profile	low profile
Volume [ml]	0.15	0.15	0.15	0.15	0.15	0.15
Cut corner	H1	H1	H1	H1	H1	H1
Pack of	50 pieces (10 plates per bag)	50 pieces (10 plates per bag)	50 pieces (10 plates per bag)	50 pieces (10 plates per bag)	50 pieces (10 plates per bag)	50 pieces (10 plates per bag)
Cat. No.	781541	781542	781543	781544	781545	781546

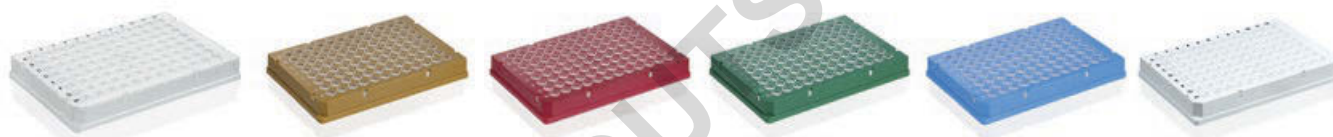

96-well plates, rigid frame, semi-skirted, standard profile

- Reliable sample identification with alphanumeric codes
- Semi-skirted plates are suitable for labeling or applying a bar code
- Sturdy PC frame for optimum handling and reliable closure

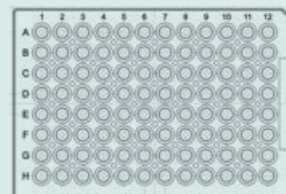

96-well, rigid frame, semi-skirted, standard profile



Frame color	transparent	blue
Well color	transparent	transparent
Profile	standard	standard
Volume [ml]	0.2	0.2
Cut corner	A12	A12
Pack of	50 pieces (10 plates per bag)	50 pieces (10 plates per bag)
Cat. No.	781547	781548



96-well plates, rigid frame, semi-skirted, for Roche LightCycler 480

- White PCR plate optimized for qPCR use in the Roche LightCycler 480
- Semi-skirted plates are suitable for labeling or applying a bar code

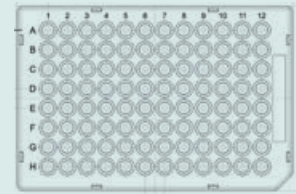

96-well, rigid frame, semi-skirted, low profile



Frame color	transparent
Well color	white 
Profile	low profile
Volume [ml]	0.15
Cut corner	H12
Pack of	50 pieces (10 plates per bag)
Cat. No.	781549



User information

White PCR products

BRAND offers specially designed white PCR disposables for optimum results in quantitative PCR (qPCR). These white PCR plates and tubes offer the highest possible sensitivity and high-precision fluorescence detection.

Compared to conventional transparent plates, white PCR products maximize the reflection signal and permit measurement of even the smallest signals.

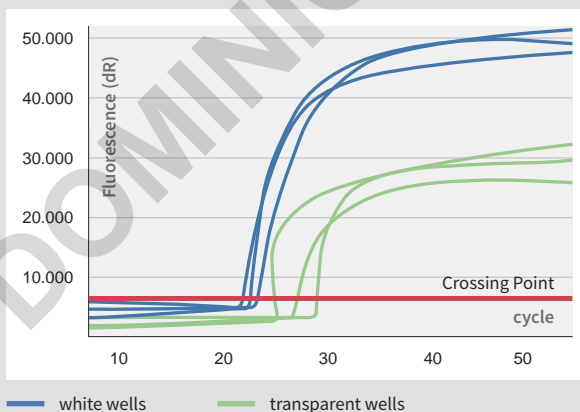

qPCR amplification of 100 ng, 10 ng, and 1 ng of human DNA, with white plates (blue lines) and clear plates (green lines). With white PCR products, the crossing point (cp) threshold is reached faster, and the measured fluorescence at endpoint is significantly greater.

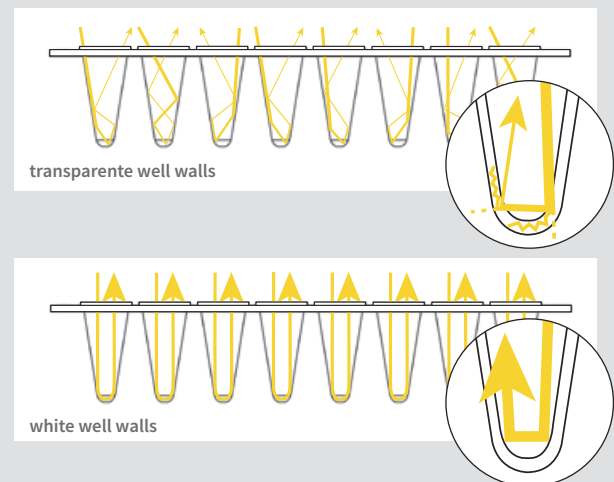

White walls also protect the PCR products prior to signal transfer throughout the thermocycler block. Thus, measurements are unaltered and more precise.

7.4 384-well PCR plates



- ✓ For applications in automation and high-throughput analyses
- ✓ Rapid heat transfer through thin vessel walls
- ✓ Can be sealed reliably with self-adhesive sealing films

BRAND 384-well PCR plates are an economical solution for automated high-throughput analyses. The thin walls allow fast transmission of the temperature specified by the cycler, thus reducing cycle times.

The stable design of the plates makes them ideal for automation, as they can be gripped by robot systems without twisting.

To minimize evaporation with small sample volumes and to prevent contamination, seal the plates with the appropriate sealing film.

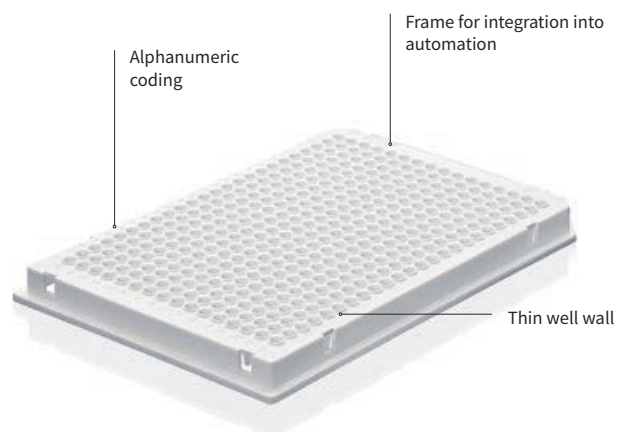

Applications

- + High throughput analyses
- + Automated process sequences
- + PCR arrays

Features

- + Made of PP in low profile
- + Compatible with most cyclers
- + 40 μ l wells for use with sample volumes between 2 μ l and 30 μ l
- + Rigid edges for ideal hold in automated applications
- + Available with a bar code

User information

To achieve good results throughout the entire plate, the plates must fit the cycler exactly. The plates must be tightly sealed to prevent evaporation. This is the only way to obtain reliable results.

The right plate for your automated system:

- Skirted plates allows the plate to be gripped with different gripper systems
- Rigid plates with reinforced covers provide increased stability
- All plates are low profile.



We advise against autoclaving PCR products. Autoclaving can be a source of contamination for disposable products.

Technical information & Ordering data

384-well plates, skirted

- Transparent wells for optimal control
- Especially rigid for secure handling with robots and automated pipetting systems
- Labels and coding for easy identification

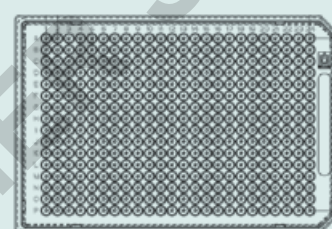

384-well, skirted

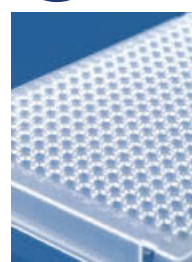

Type	low profile	low profile
Color	transparent	transparent
Volume [ml]	0.03	0.03
Cut corner	A24, P24	A24
Pack of	50 pieces (10 plates per bag)	50 pieces (10 plates per bag)
Cat. No.	781345	781346



384-well plates, skirted, for Roche Light Cycler

- White wells for better fluorescence measurement
- Optimal for Roche LightCycler 480 and comparable devices
- Labels and coding for easy identification

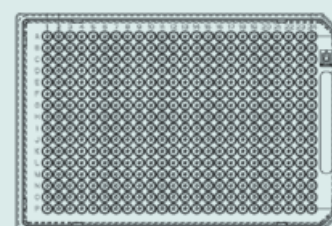

384-well, skirted, for Roche Light Cycler



Type	low profile
Color	white 
Volume [ml]	0.03
Cut corner	A24, P24
Pack of	50 pieces (10 plates per bag)
Cat. No.	781358



7.5 Rigid Frame 384-well PCR plates

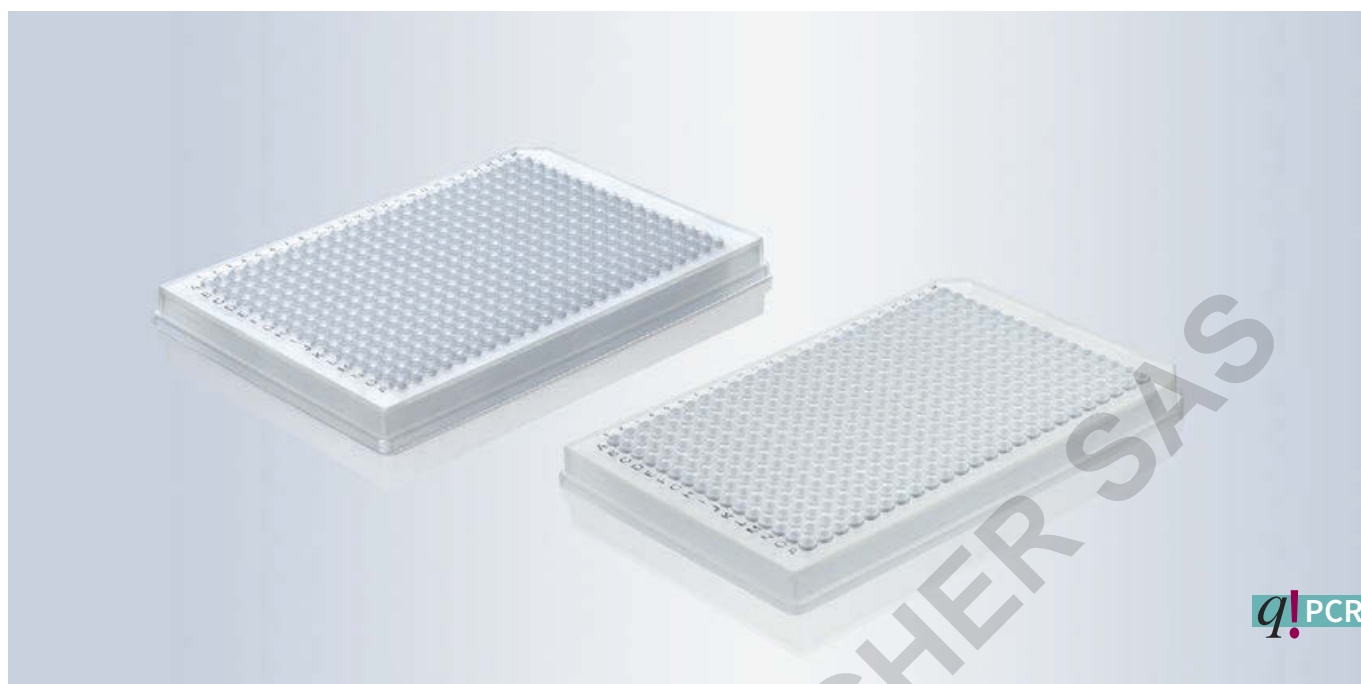

- ✓ For applications in automation and high-throughput analyses
- ✓ Rapid heat transfer through thin vessel walls
- ✓ High stability and rigidity of the plate due to the polycarbonate frame

BRAND 384-well PCR plates are an economical solution for automated high-throughput analyses. Our Rigid Frame PCR plates have a strong polycarbonate frame to ensure safe handling in robots and optimal evaporation protection. The rigid frame also allows the use of very thin-walled wells from 100% virgin medical grade polypropylene. The uniform and thin wall thicknesses of the wells ensure rapid transfer of the temperature from the cycler to the sample, thus reducing cycle times.

For qPCR, plates with white wells are available that optimally reflect the fluorescence signals.

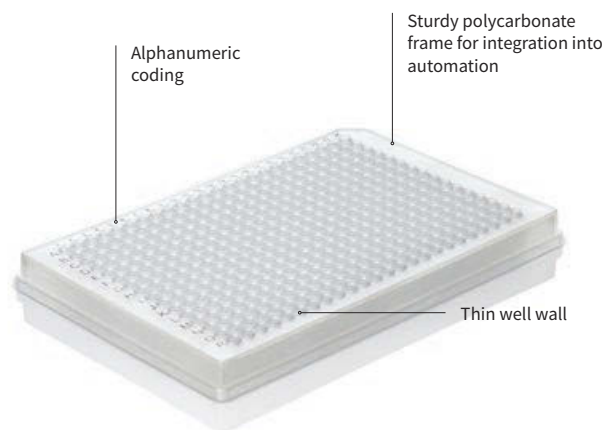

Applications

- + High throughput analyses
- + Automated process sequences
- + PCR arrays

Features

- + Made of pure PP and PC, low profile
- + Compatible with most cyclers
- + 40 μ l wells for use with sample volumes between 2 μ l and 30 μ l
- + Rigid edges for ideal hold in automated applications

Technical information & Ordering data

384-well plates, rigid frame, skirted

- Transparent wells for optimal control
- Especially rigid for secure handling with robots and automated pipetting systems
- Labels and coding for easy identification

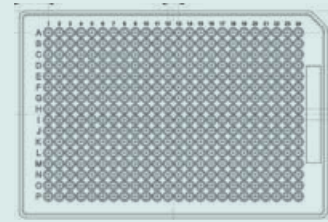

384-well,
skirted



Frame color	frosted
Well color	transparent
Volume [ml]	0.03
Cut corner	A24
Pack of	50 pieces (10 plates per bag)
Cat. No.	781538



384-well plates, rigid frame, skirted, for Roche Light Cycler

- White wells for better fluorescence measurement
- Optimal for Roche LightCycler 480 and comparable devices
- Labels and coding for easy identification

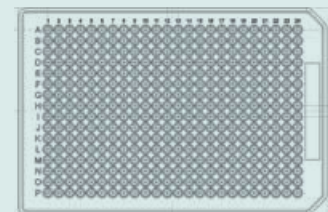

384-well, skirted,
for Roche Light Cycler



Frame color	frosted
Well color	white 
Volume [ml]	0.03
Cut corner	A24, P24
Pack of	50 pieces (10 plates per bag)
Cat. No.	781539



Application Note

Higher sensitivity of qPCR reactions with BRAND 384-well PCR plates

Author: BRAND GMBH + CO KG

Introduction

In many laboratories transcriptase quantitative PCR has become a standard technique to correlate phenotypic observations not only with altered protein expression data but also with quantitative changes. The quality of results obtained by RT-qPCR depends on several factors, including, but not limited to, adequate primers for reverse transcriptase and qPCR response, proper RNA sample preparation and well-defined reference genes. However, the best experimental design will give poor results if external factors like malfunction of thermocyclers and inadequate PCR-vessels disturb the reaction.

Here we show, for example, that signal amplification is improved with white 384-well PCR plates from BRAND when compared with the white plates of another well-known manufacturer.

Material and Methods

Murine hippocampi were homogenized in peqGOLD RNAPure™ buffer (PeqLab) with TissueLyser (Qiagen). Total RNA was extracted using RNeasy Kit (Qiagen). cDNA was synthesized from 1 µg total RNA using iScript™ cDNA Synthesis Kit (Bio-Rad).

For RT-qPCR the following reaction was set up:

0.5 µl	Primer 5 µM
5 µl	SYBR®select (2X)
1 µl	cDNA
3 µl	H ₂ O
<hr/>	
10 µl	total

SYBR® Green based gene expression reactions were loaded in triplicates in white 384-well PCR plates from BRAND (#781358) and a competitor. Plates were sealed with qPCR sealing films from BRAND (#781391). PCR was performed in the CFX384™ real-time PCR machine (Bio-Rad).

Results

In the two different white 384-well PCR-plates none of the PCR-reactions failed. However, signal intensity was much stronger in the BRAND plates when compared to the competitor.

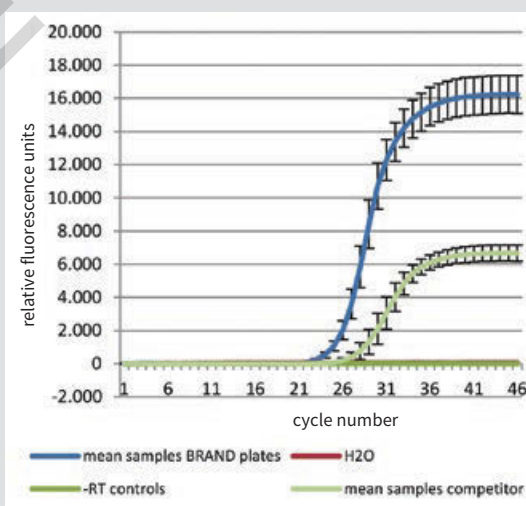

Figure: Data show mean and standard deviation of 384 RT-qPCR results per plate.

Conclusion

RT-qPCR runs more efficiently in the white 384-well PCR-plates from BRAND in comparison with the plates from another well-known manufacturer as indicated by the slope and the plateau of the two different curves. This might be the result of optimized thin walled wells leading to a fast and homogenous thermal transfer, and by the use of raw materials from which less PCR-inhibiting substances could be released.



8. Sealing options

A reliable seal on samples is essential to protect them from contamination and evaporation during the PCR assay and during subsequent measurements. The proper seal must be selected to match the type of PCR assay conducted, as well as the PCR vessel used. Highly transparent films, for instance, are required to calculate reliable values during a real-time PCR, since the measurement is completed directly in the cyclor.

In addition to choosing the right sealing option, how the film or cap is handled plays a key role in effectively protecting your samples.

Whether you choose film or cap strips: BRAND offers the right seal for any application. We provide reliable, convenient sealing options even for very small sample quantities.

8.1 PCR cap strips



- ✓ Effective protection against evaporation and contamination
- ✓ The right cap shape for your application
- ✓ Easy to open and close without risk of contamination

With PCR cap strips you can seal PCR strips and plates with 24, 48, and 96 wells reliably, and protect your samples effectively against evaporation and contamination. To prevent contamination, the cap strips are equipped with two side tabs for exact positioning before closing and a small opening attachment on each cap. This prevents contact with the inside of the cap.

The highly transparent flat cap strips are ideal for qPCR because the cap shape allows accurate fluorescence measurement. With domed cap strips, thermal cyclers without pressure sensors exert a stronger force, thus further increasing the sealing effect.

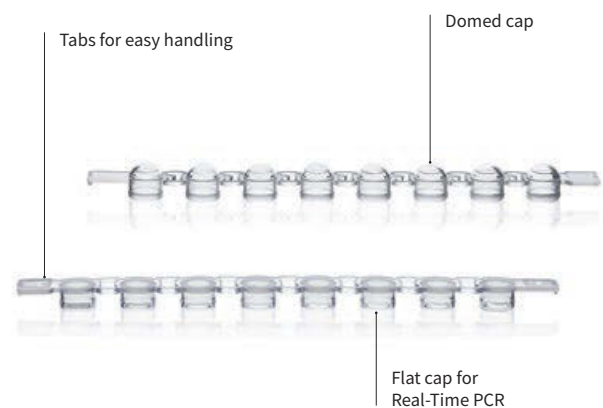

Applications

- + Sealing of PCR strips
- + Sealing of PCR plates

Features

- + Easy to attach and remove
- + Tight sealing on both strips and plates
- + Highly transparent, flat cap strips for optical measurements
- + Side grip tabs for easy, contamination-free handling

User information

Flat or domed?

- Flat cap strips are especially well-suited for optical measurements. The measurements can be completed directly through the cap.
- Domed caps increase the closing pressure from the lid of the thermocycler, and prevent small leaks.
- It is important to select caps depending on the cycler chosen.

Contamination-free handling:

- Sealing samples early on avoids cross-contamination and protects samples.
- The side grip tabs and attachments on every cap allow for contamination-free handling.



We advise against autoclaving PCR products. Autoclaving can be a source of contamination for disposable products.

Accessories

Cap Tool

For reliable sealing and opening of cover caps. Handy and lightweight material for fatigue-free operation. Pack of 1.

Cat. No.

781419



Ordering information for BRAND liquid handling equipment is available at shop.brand.de

Technical information & Ordering data

Strips of 8 PCR caps

- Domed or flat
- Easy to open and close
- Grip tabs and cap attachments for careful, contamination-free opening
- For sealing of strips and plates

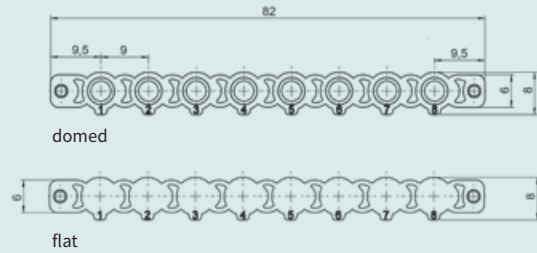

Strips of 8 caps, flat

Cap design	flat
Color	transparent
Pack of	1000 pieces (8 bags of 125 strips)
Cat. No.	781334

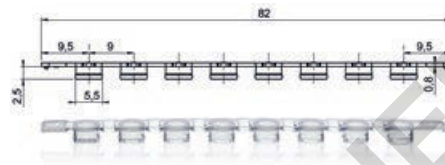

Strips of 8 caps, domed

Cap design	domed	domed	domed	domed	domed
Color	transparent	rose	yellow	green	blue
Pack of	1000 pieces (8 bags of 125 strips)	1000 pieces (8 bags of 125 strips)	1000 pieces (8 bags of 125 strips)	1000 pieces (8 bags of 125 strips)	1000 pieces (8 bags of 125 strips)
Cat. No.	781340	781341	781342	781343	781344



Strips of 12 PCR caps

- Easy to open and close without tools
- Grip tabs and cap attachments for contamination-free opening

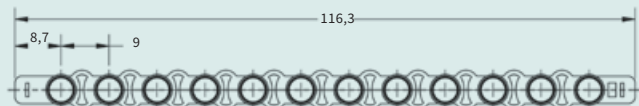

Strips of 12 caps, domed

Cap design	domed
Color	transparent
Pack of	1500 pieces (12 bags of 125 strips)
Cat. No.	781290

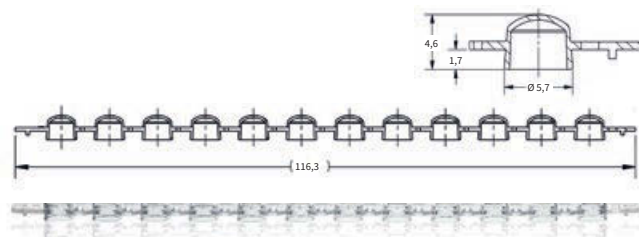

8.2 Sealing films



- ✓ Temperature stability up to 120 °C
- ✓ Tight seal minimizes evaporation
- ✓ Highly transparent for use in qPCR methods

Whether standard PCR, qPCR or digital droplet PCR, the source material is always valuable and the volume always low. To protect samples and maintain their sensitivity at the same time, PCR samples must be perfectly sealed.

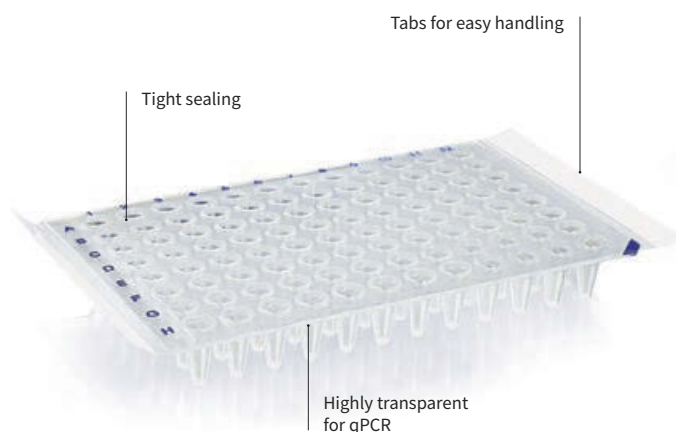

Applications

- + PCR and qPCR
- + For short-time storage or transportation of valuable PCR samples
- + For contamination prevention at high-throughput analyses

Features

- + Easy to apply and remove without expensive equipment
- + Reliable adhesion for optimum protection and minimized evaporation loss
- + Highly-transparent films for optimal measurement results

User information

- The pressure-sensitive sealing film 781391 can be easily repositioned for a perfect seal thanks to pressure-sensitive adhesive beads which are only activated when pressure is applied.
- The film must be pressed on evenly with a sealing paddle to ensure proper seal. Please check the edges for an optimal result.
- Highly adhesive films will be difficult to remove. The plate must be fixed properly during removal to prevent spills.
- Heat sealing films are also available for maximum protection.



For long-term storage, ensure films have good temperature stability.



Accessories

Sealing paddle

The sealing paddle helps to apply self-adhesive films. Thanks to its streamlined sides and rounded shape, it rests comfortably in your hand and ensures optimal force transfer. Pack of 2.

Cat. No. 701381



PCR box/ rack, PP

Assorted colors (red, yellow, green, purple, blue). Suitable for sample preparation, for keeping and storing 0.2 ml single tubes, 8-strips and 12-strips, and 96-well PCR plates. These racks can also be stacked without lids. Withstand temperatures from -80 to +121 °C. Pack of 5.

Cat. No. 781362



Mini cooler PCR, PP

With transparent lid. For protecting samples from warming. The mini PCR cooler keeps samples at 4 °C for approximately 3 hours. The insulating gel changes from violet to pink at 7 °C. Suitable for 0.2 ml single tubes, 8-strips, and 12-strips, as well as 96-well PCR plates. Pack of 2.

Cat. No. 781260



Technical information & Ordering data

qPCR film

- For real-time PCR, ELISA and other colorimetric applications
- Highly transparent with minimal autofluorescence
- Pressure-dependent adhesive capsules allow for easy attachment (#781391)
- Free of RNase/DNase



qPCR film

Description	film	film strips
Material	polyester 	polyester 
Pack of	100 pieces	400 pieces (50 sheets of 8 strips)
Cat. No.	781391	781383

PCR film

- For PCR, ELISA, EIA and other optical applications
- Transparent for visual inspection of samples
- Simple handling and secure attachment with two grip tabs
- Minimal evaporation thanks to strong adhesive



PCR film

Description	film
Material	polyester
Pack of	100 pieces
Cat. No.	781390

Film for PCR and storage

- For PCR, ELISA and sample storage
- DMSO resistant with strong adhesive that is highly resistant to solvents
- Temperature stability down to -80 °C
- Can be removed without leaving a residue (#701376 und 701377)



Film for PCR and storage

Description	film	film	film
Material	polypropylene	PET	aluminium
Pack of	100 pieces	100 pieces	100 pieces
Cat. No.	701367	701376	701377

Heat sealing film for storage and transport

- Heat sealing technology for effective and durable plate sealing
- Aluminum films for low temperatures and applications with solvents
- Transparent foil for qPCR and colorimetric assays



Heat sealing film

Description	film	film	film
Material	aluminium	PE	aluminium
Pack of	100 pieces	100 pieces	100 pieces
Cat. No.	701430	701431	701432

Application Note

BRAND PCR plates and PCR sealing films – a perfectly adjusted system

Author: BRAND GMBH + CO KG

Introduction

The PCR plates from BRAND are designed to support polymerase chain reactions in several ways. The source materials selected are free of PCR inhibitors and the smooth vessel interior minimizes the binding of enzymes and nucleic acid to the walls. In addition, the ultra thin-walled PCR plate design facilitates constant, rapid and precise heat transfer leading to convincing yields and short PCR cycle times.

Generating the desired PCR product and shielding it from evaporation are decisive elements of a successful PCR. The innovative self-adhesive press-to-seal sealing film wins over with easy handling; it is not tacky to the touch and provides superior evaporation protection. The film is highly transparent and can be used for measuring the smallest signals during optical measurements like Real-Time PCR.

The BRAND PCR plates and the BRAND PCR sealing films form a masterfully tuned system. The surfaces of the PCR plates and the adhesive side of the sealing films are tailored to each other and reach striking results.

Material & Methods

Devices:

Thermal cycler Biometra T1	
Precision scale Sartorius CP 225 D	
Transferpette® S	(#7047 78)
Pipette tips 200 µl	(#7320 08)
TipBox	(#7322 08)
Roller	(#7013 80)
Reagent reservoir	(#7034 59)

PCR systems:

BRAND PCR system:
PCR plate (#781368)
with sealing film (#781391)
Competitor 1 PCR system:
PCR plate with matching sealing film
Competitor 2 PCR system:
PCR plate with matching sealing film

Chemicals reagents:

Water (10 ml [50 µl each well])
Cationic dye methylene blue

Measurement of evaporation losses of different PCR systems

A mixture of water with the cationic dye methylene blue was prepared. In each PCR plate every well was filled with 50 µl of the water dye mixture and sealed with adhesive sealing film. The weighed portion of the plates and the sealing films was determined before and after the filling of the wells. The roller was used to ensure a firm seal. The PCR plates were then put into the thermal cycler Biometra T1 and a PCR run was performed (table 1).

Temperatures and times during the thermal cycler process (table 1)

Temperature	Time
94 °C	3 min
94 °C	30 sec
50 °C	30 sec
72 °C	30 sec
72 °C	10 min

Finally, the weighting portion of the PCR plates was examined again.

Analysis and Results

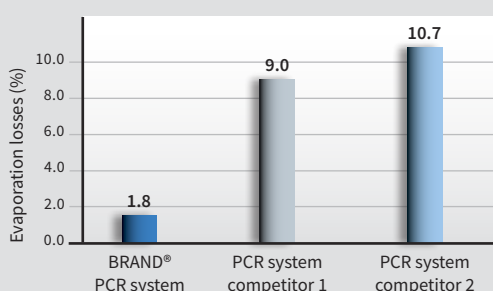

The percentaged evaporation losses of the different PCR systems were determined and represented in a graph (figure 1).



Conclusion

To obtain successful PCR results it is important to use a harmonizing PCR system. The PCR plates have to be securely sealed to preserve the generated PCR products. The adhesive surface of the highly transparent self-adhesive sealing film of BRAND goes hand in hand with the surface of the BRAND PCR plates. The encapsulated, pressure sensitive adhesive keeps the film easy to handle and non-tacky to the touch. After sealing, areas above the sample wells remain adhesive free and do not distort PCR samples. On top the ultra-thin liner and high transparency allow detection of smallest signals during the Real-Time PCR.

PCR products at a glance

Low throughput

Single PCR tubes

page 94



- Volume: 0.2 and 0.5 ml
- Various colors available
- Sealing options:
 - flat cap (attached)
 - domed cap (attached)

PCR strips

page 97



- Volume: 0.15 and 0.2 ml
- 8- and 12-tube strips
- Various colors available
- Sealing options:
 - cap strips, attached or detached, domed or flat caps
 - single flat caps
 - sealing film strips

24-well PCR plates

page 102

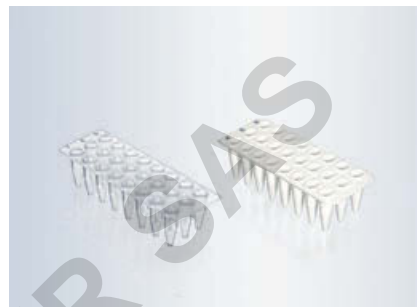

- Volume: 0.2 ml
- White or transparent
- Sealing options:
 - cap strips
 - sealing film strips

Plate designs

Standard / low profile

Depending on the sample volumes



Non-skirted, semi-skirted, skirted

Non-skirted PCR plates are suitable for most commercially available thermal cyclers.

Semi-skirted PCR plates can easily be labeled or tagged with a barcode.

Skirted PCR plates are especially rigid, and are optimally suited for use with automatic pipetting systems.



High throughput

48-well PCR plates

page 102

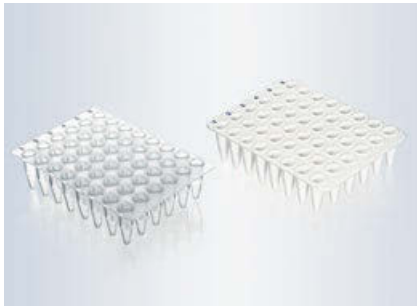

- Volume: 0.2 ml
- White or transparent
- Sealing options:
 - cap strips
 - sealing film strips

96-well PCR plates

page 104



- Volume: 0.15 and 0.2 ml
- White or transparent
- Sealing options:
 - cap strips
 - sealing film or sealing film strips

384-well PCR plates

page 112



- Volume: 2 - 30 μ l
- White or transparent
- Sealing options:
 - sealing film
- Suitable for Roche LightCycler 480

Sealing options

Cap strips

page 118



- Optimal seal for 8-tube strips or individual plate rows.
- Reliable seal thanks to optimized fit, even for plates.
- Available domed and flat



Sealing film strips

page 121

Sealing film strips for quickly and reliably sealing strips and plate areas.



Sealing films

page 121

- Fast, reliable seal for whole plates to prevent evaporation
- Highly transparent film for use in real-time PCR





SAMPLE STORAGE

Safe and reliable storage is essential to working efficiently in the laboratory. In addition to selecting and complying with specific storage conditions, having the right storage containers plays a key role. Samples must be protected against aging and contamination over long periods of time. In addition to appropriate temperature stability, volume, and format, containers also need to provide space-saving storage and easy identification to handle large numbers of samples.

To manage such samples, BRAND offers a range of microtubes with screw caps, deep-well plates and 96-well tube racks providing simple and efficient solutions for sample storage at temperatures down to -196°C . Alphanumeric codes, individually coded tubes, bar codes, colored screw caps or cap inserts facilitate fast sample identification and ensure efficient sample management. Different styles of cryogenic tubes are available for long-term storage.



Chapter III

Sample storage work areas

Storage down to -80 °C

Storage down to -196 °C



9.1 Microtubes with snap lid p. 131



9.2 Microtubes with lid closure p. 134



9.3 Microtubes with screw cap p. 137



10.1 Microtubes with silicone seal p. 150



10.2 Cryogenic tubes p. 156



9.4 96-well microplates PP, and deep-well plates PS, p. 140



9.5 Deep-well plates PP p. 143



9.6 Tube racks p. 147

- Long-term storage of non-critical samples
- Intermediate storage of sensitive samples

- Sample databases
- Storage of cells
- Long-term storage



9. Sample storage down to -80°C

If the number of samples in use increases and processes are automated, laboratories need to store large quantities of samples for longer time periods. We recommend storage at -80°C for long-term protection of samples.

Key characteristics of storage plates and tubes are compact formats for space saving storage, secure closure, easy handling and versatile materials for flexible applications.

BRAND offers a large number of different storage options that reliably protect samples down to -80°C and are easily integrated into different applications. Deep-well plates allow for space-saving storage of large numbers of samples. The ANSI/SLAS format of deep-well plates allows for the utilization with automated processes and for creating large sample libraries. Tight-sealing microtubes with screw caps or lid closure and tube racks allow for space saving storage of many samples and the taking of individual samples at the same time.

9.1 Microtubes with snap lids



- ✓ Tight sealing snap lid
- ✓ Can be opened and closed with one hand
- ✓ Available in different colors for clear sample identification

It is important to store samples securely so that they are protected against contamination during long procedures. Convenient handling is also important for ensuring processes can be completed quickly.

Microtubes with snap lids from BRAND offer tight-sealing lids with convenient lid opening mechanisms. They are also available in different colors to facilitate easy identification guaranteeing smooth work processes.

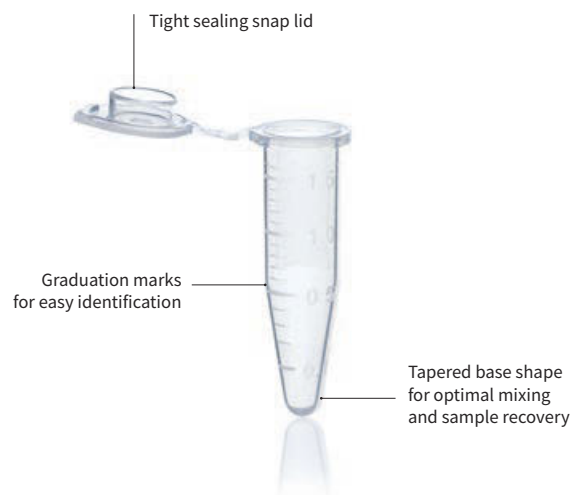

Applications

- + Aliquoting
- + DNA and RNA isolation and purification
- + Use in analysers
- + Sample dilution
- + Short-term sample storage

Features

- + Tight-sealing lid
- + Available in sizes 1.5 ml and 5 ml
- + Highly transparent
- + Autoclavable at 121 °C (2 bar), acc. DIN EN 285

User information

- The microtubes 1.5 ml and 5 ml with snap lids can be centrifuged up to 20,000 resp. 25,000 x g. The rotor fit and tared weight distribution must be taken into consideration. Even minimal weight differences can cause an imbalance and damage both the centrifuge and the vessel.

Caution: The relative centrifugal force (RCF) is dependent on the radius of the rotor and the speed (RPM) of the centrifuge.

General conversion formula:

$$g = RCF = ((U/min)/1000)^2 \cdot r \cdot 1.118$$

g-force: Gravitational acceleration

RCF: Relative centrifugal force
(corresponds to the g-force)

r: Rotation radius

U/min: Rotor revolutions per minute (speed)

- Microtubes should not be filled to the top during freezing, due to volumetric expansion. The recommended fill levels correspond to the top graduated lines.



The microtubes with snap lids are not recommended for long-term storage of samples. We recommend using microtubes with a screw cap (chapter III) or cryogenic tubes (chapter I). These allow for safe long-term storage, preventing the lid from breaking.



Refrigerated or frozen samples generally used in testing should be exposed to the smallest temperature fluctuations possible. Try to maintain the temperature using a mini cooler or avoid frequent thawing during aliquoting.

Accessories

Microtube rack, PP

Stackable racks with alphabetical positions. Operating temperature -20 °C to +90 °C. Autoclavable at 121 °C (2 bar), acc. DIN EN 285. Density 1.2 g/cm³. Will not float in waterbath. Pack of 5.



For Ø up to mm	Positions	white Cat. No.	blue Cat. No.	red Cat. No.
11	8 x 16	4341050	4341051	4341052
13	6 x 14	4341000	4341001	4341002

Microtube rack, PP

Numbered positions for 20 microtubes, 1.5 ml. Autoclavable at 121 °C (2 bar), acc. DIN EN 285. Pack of 1.

Cat. No. 7806 05



Mini cooler, PC

Durable polycarbonate filled with non-toxic gel. Mini coolers hold twelve 0.5 ml to 2.0 ml tubes. Pack of 1.



Bench temp. maintained	Time held	Color	Cat. No.
0 °C	60 min.	red	114930
-20 °C	60 min.	yellow	114935
-70 °C	45 min.	white	114940



Technical information & Ordering data

Microtubes with snap lid

- Easy handling with perfectly sealing and easy-to-open lids to protect against contamination
- Frosted marking area
- Autoclavable at 121 °C (2 bar), acc. DIN EN 285

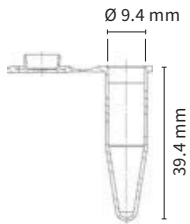

1.5 ml microtubes
with snap lid



Color	transparent	yellow	blue	green	orange	amber
Outer-Ø [mm]	10.7	10.7	10.7	10.7	10.7	10.7
RCF max. (at 20 °C, t 20 min)	20,000	20,000	20,000	20,000	20,000	20,000
Pack of	500 pieces	500 pieces	500 pieces	500 pieces	500 pieces	500 pieces
Cat. No.	780420	780421	780422	780423	780424	780425

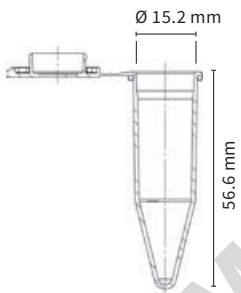

5 ml microtubes
with snap lid

Color	transparent
Outer-Ø [mm]	16.6
RCF max. (at 20 °C, t 20 min)	25,000
Pack of	250 pieces
Cat. No.	780555



9.2 Microtubes with lid closure



- ✓ Highly transparent
- ✓ Lid closure for secure storage
- ✓ Suitable for centrifugation up to 30,000 x g

Microtubes with lid closure allow for sample storage down to -80 °C with easy, consistent handling. Practical lids are convenient for opening and closing quickly and easily with one hand. Their high-purity polypropylene and high transparency make them ideal storage vessels especially for valuable samples.

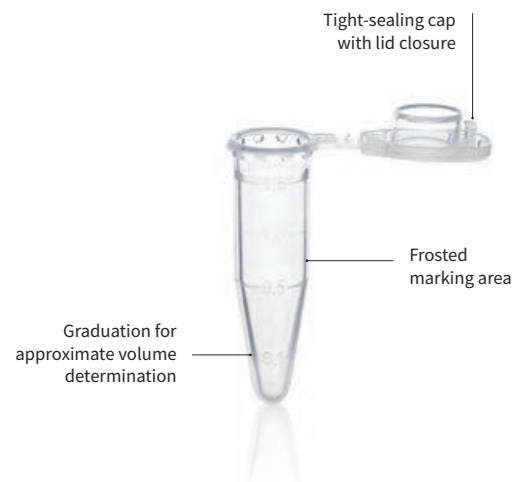

Applications

- + Sample storage
- + Aliquoting and sample preparation
- + Extracting nucleic acids and proteins
- + Screening tests
- + For use in analysers

Features

- + Tight-sealing caps with lid closure
- + Withstand centrifugation up to 30,000 x g
- + Autoclavable at 121 °C (2 bar), acc. DIN EN 285



User information

Microtubes are exposed to high loads in general, and in particular under thermal stress, such as during thermal denaturation. The biggest danger is that the lid may break open as pressure increases. Microtubes with lid closures provide optimal protection due to the significantly higher force required to open them. This graphic shows lid opening forces in Newtons (N).



The lid closure protects against accidental opening of the lid.



The wide lid rim facilitates one-handed operation.

Correct thawing

Significant temperature fluctuations put a strain not only on the materials used in vessels, but on the samples as well. Because of this, avoid frequent thawing and freezing, and thaw samples stored at -80°C slowly and carefully. Clean the exterior of the sample vessel thoroughly after thawing to remove any contamination.

Lid opening force

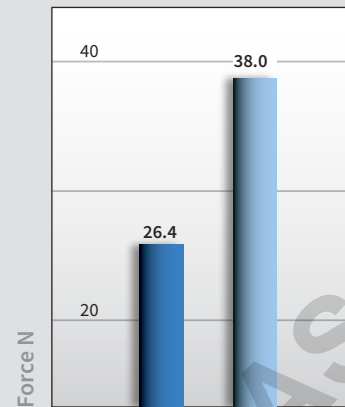

BRAND microtubes with lid closure
Standard microtubes

Thawing tips:

- Thaw slowly (overnight in a 4°C refrigerator)
- Thaw in a water bath with constant circulation
- Do not actively apply heat



Accessories

Microtube rack, PP

Stackable racks with alphabetical positions. Operating temperature -20°C to $+90^{\circ}\text{C}$. Autoclavable at 121°C (2 bar), acc. DIN EN 285. Density 1.2 g/cm^3 . Will not float in waterbath. Pack of 5.



For \varnothing up to mm	Positions	white Cat. No.	blue Cat. No.	red Cat. No.
11	8 x 16	4341050	4341051	4341052
13	6 x 14	4341000	4341001	4341002

Microtube rack, PP

Numbered positions for 20 microtubes, 1.5 ml. Autoclavable at 121°C (2 bar), acc. DIN EN 285. Pack of 1.

Cat. No. 7806 05



Mini cooler, PC

Durable polycarbonate filled with non-toxic gel. Mini coolers hold twelve 0.5 ml to 2.0 ml tubes. Pack of 1.



Bench temp. maintained	Time held	Color	Cat. No.
0°C	60 min.	red	114930
-20°C	60 min.	yellow	114935
-70°C	45 min.	white	114940

Technical information & Ordering data

Microtubes with lid closure

- Lid closure to ensure good lid security
- High transparency
- Frosted marking area



Microtubes with lid closure

Volume	0.5 ml	1.5 ml	2.0 ml
Lid membrane thickness [mm]	0.3	0.4	0.5
Outer-Ø [mm]	10.0	12.8	12.8
Height with closed lid [mm]	30.0	38.8	40.0
RCF max. (at -5 °C, t 20 min)	30,000	30,000	20,000
Pack of	500 pieces	1000 pieces	500 pieces
Cat. No.	780536	780540	780546

9.3 Microtubes with screw cap and plug seal



- ✓ Screw cap with plug seal ensures secure closure
- ✓ Silicone-free
- ✓ Microtubes with round bottom withstand RCF to 17,000 x g (at 20 °C, 20 min)

Expensive reagents and formulations are best protected in microtubes with screw caps. A screw cap offers reliable protection, preventing accidental opening. The plug seal in the cap ensures a secure closure, to provide a tight seal for excellent protection against freeze drying and without the danger of silicone contamination. This means they are an especially good choice for sensitive samples.

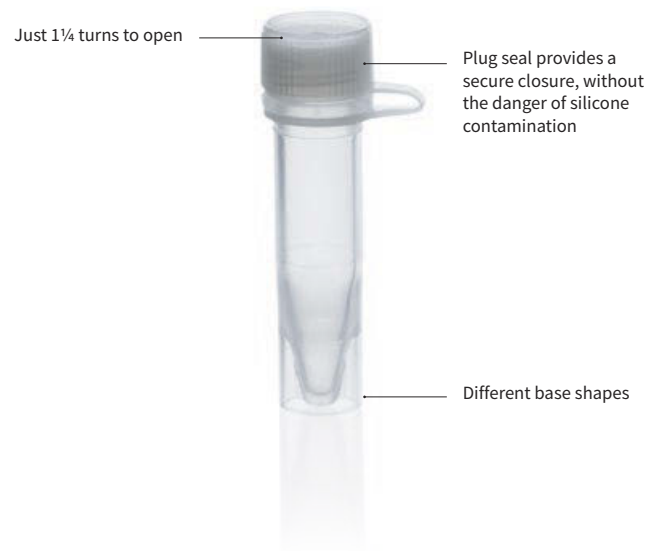

Applications

- + Aliquoting reagents
- + Storage of sensitive samples
- + Storage of biological materials, such as serums or blood samples
- + Preparing formulations

Features

- + Tubes made of highly transparent polypropylene
- + Non-graduated
- + Silicone-free
- + Colored cap inserts available for sample identification

User information

- Ideal for storing sensitive samples and for heating and centrifuging samples. The plug seal minimizes the risk of samples freeze drying, reliably protecting even your most valuable samples.
- Tubes with screw cap should not be filled to the top during freezing due to volumetric expansion.
- Microtubes with a plug seal are a good choice to prevent silicone seal contamination of sensitive samples during storage.



Self-standing tubes with a foot-rim can easily be opened in the rack with one hand



Accessories

Cryogenic tube rack

For self-standing cryogenic tubes and tubes with screw cap. Pack of 4.

Cat. No. 114860



Mini cooler, PC

Durable polycarbonate filled with non-toxic gel. Mini coolers hold twelve 0.5 ml to 2.0 ml tubes. Pack of 1.



Bench temp. maintained	Time held	Color	Cat. No.
0 °C	60 min.	red	114930
-20 °C	60 min.	yellow	114935
-70 °C	45 min.	white	114940

Microtube rack, PP

Stackable racks with alphanumeric positions. Operating temperature -20 °C to +90 °C. Autoclavable at 121 °C (2 bar), acc. DIN EN 285. Density 1.2 g/cm³. Will not float in waterbath. Pack of 5.



For Ø up to mm	Positions	white Cat. No.	blue Cat. No.	red Cat. No.
11	8 x 16	43410 50	43410 51	43410 52
13	6 x 14	43410 00	43410 01	43410 02

Microtube rack, PP

Numbered positions for 20 microtubes, 1.5 ml. Autoclavable at 121 °C (2 bar), acc. DIN EN 285. Pack of 1.

Cat. No. 7806 05





Technical information & Ordering data

Microtubes with attached screw cap with plug seal, non-sterile

- High-purity polypropylene tube and PE screw cap
- Perfect cap seal to protect against evaporation and freeze drying
- Operating range -90 °C to +100 °C
- Not autoclavable



Attached screw caps with plug seal, non-sterile

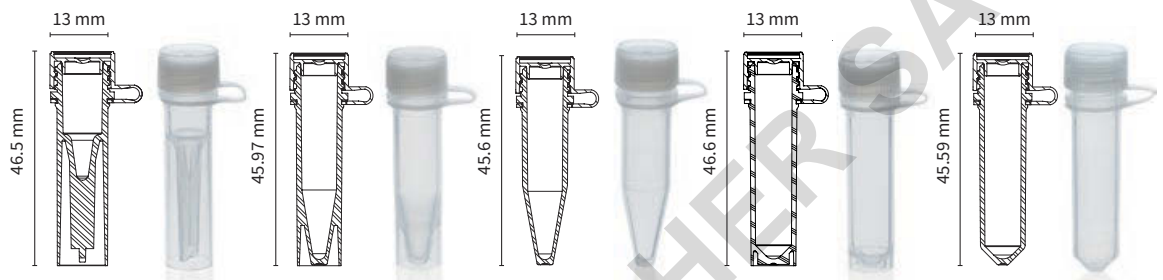

Capacity	0.5 ml	1.5 ml	1.5 ml	2 ml	2 ml
Height [mm]	46.5	45.97	45.6	46.6	45,59
Outer-Ø [mm]	13	13	13	13	13
Description	self-standing	self-standing	round-bottom	self-standing	round-bottom
Pack of	1000 pieces	1000 pieces	1000 pieces	1000 pieces	1000 pieces
Cat. No.	780700	780701	780702	780703	780704

Cap inserts for microtubes, high purity PP



Color	white	blue	red	green	yellow
T _{min} -T _{max}	-196 °C to +121 °C	-196 °C to +121 °C	-196 °C to +121 °C	-196 °C to +121 °C	-196 °C to +121 °C
Pack of	500 pieces	500 pieces	500 pieces	500 pieces	500 pieces
Cat. No.	780720	780721	780722	780723	780724

9.4 96-well microplates, PP & deep-well plates, PS



- ✓ ANSI/SLAS conforming
- ✓ Alphanumeric coding and cut corner for easy sample identification
- ✓ Optimal sample recovery

PP microplates and PS deep-well plates are a good choice for space-saving, short-term storage of large numbers of samples down to -20 °C. Thanks to their compact design and the option for using multi-channel pipettes or robots, they can be used to safely and reliably process even large quantities of samples.

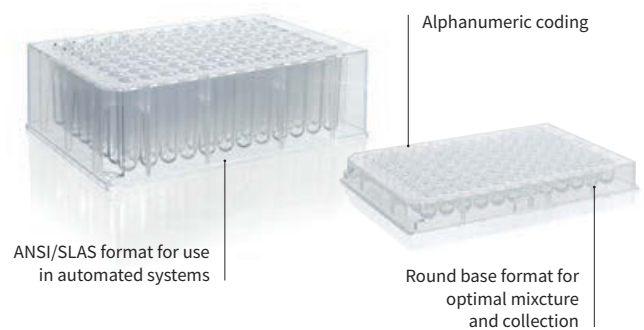

Applications

- + Sample storage down to -20 °C
- + Cultivating microorganisms
- + Extracting nucleic acids and proteins
- + Screening tests or fluorescence measurements

Features

- + Highly transparent polystyrene plate for optical measurements
- + Optimal sample collection and mixture thanks to U-shaped base
- + Usable with multi-channel systems and in automation processes
- + Alphanumeric coding for reliable sample identification



User information

- The highly transparent PS plate allows for easy visual inspection.
- The raised edges of the well protect against contamination, allowing for a secure closure using self-adhesive films.
- Barcodes can be applied to the sides for clear identification. These ensure clear classification and prevent mix-ups, even with large numbers of stored samples. An ordering form for adding bar codes to your products is available on our website:



Sealing films for automation applications



Film with adhesive-free areas, easy to puncture and highly resistant against chemicals (Cat. No. 701370).



Pre-punched film, for multiple punctures by pipette tips (Cat. No. 701374)

Additional sealing films are available in our online shop at shop.brand.de



Sealing mats

The mats are ideal for short-term storage, and reliably protect samples against contamination and evaporation. Working volumes are reduced as follows when using sealing mats:

Deep-well plate [Cat. No.]	Material	Nominal volume [ml]	Max. filling volume with sealing mat* [ml]	Sealing mat [Cat. No.]
701352	PS	1.1	1.00	701360

* approx. 2 mm space to the mat

Accessories

Sealing paddle

The sealing paddle helps to apply self-adhesive films. Thanks to its streamlined sides and rounded shape, it rests comfortably in your hand and ensures optimal force transfer. Pack of 2.

Cat. No. 701381



Ordering information for BRAND liquid handling equipment is provided at shop.brand.de



Technical information & Ordering data

96-well microplates made of PP

- Raised well edges provide protection from contamination
- Usable with multi-channel systems and automation
- Secure closure using self-adhesive sealing film

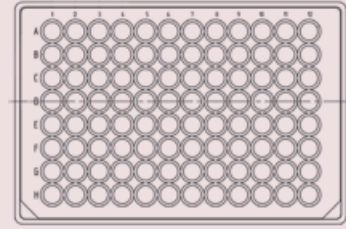

96-well microplates

14.35 mm



Volume	0.3 ml
Well shape	round
Base shape	U-bottom
Height [mm]	14.35
Pack of	100 pieces (10 pieces per bag)
Cat. No.	701330

Cover	lid
Material	PS
Pack of	50 pieces (10 pieces per bag)
Cat. No.	782152



96-well deep-well plates made of PS

- Highly transparent
- Stackable for space-saving storage
- Usable with multi-channel systems and automation

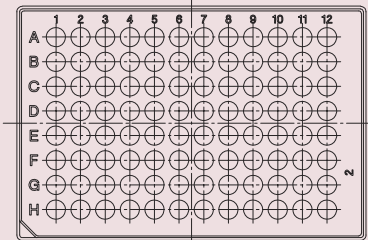

96-well deep-well plates

41 mm

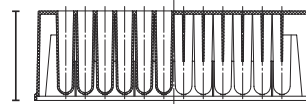

Capacity	1.1 ml
Well shape	round
Base shape	U-bottom
Height [mm]	41
Pack of	32 pieces
Cat. No.	701352

Cover	mat
Material	mod. PE
Autoclavable	no
Pack of	24 pieces
Cat. No.	701360



Tips for using sealing mats are provided on page 144.

9.5 Deep-well plates, polypropylene



- ✓ Stackable
- ✓ ANSI/SLAS format
- ✓ Alphanumeric coding and cut corners for easy well identification

The compact ANSI/SLAS format allows a large number of samples to be processed at the same time, and allows for automated processing. The format is space-saving and has optimal closure options to ensure secure storage.

With a wide range of plate formats available, there is a BRAND plate to match any application. The low-profile plate is optimized to use storage space efficiently, while the 384-well plate allows handling of a large number of samples in an automated work sequence.

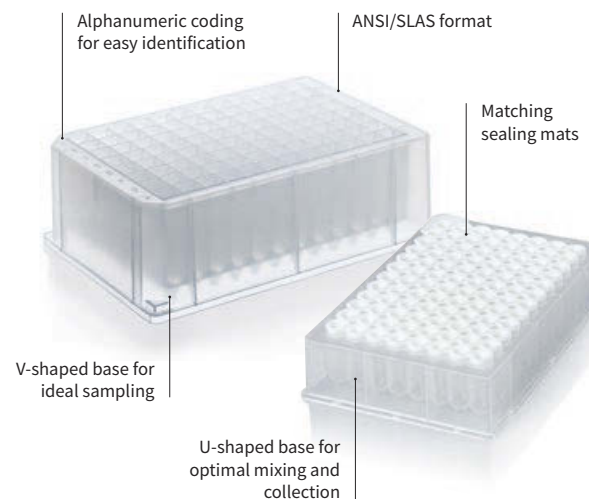

Applications

- + Sample storage
- + Cultivating microorganisms
- + Extracting nucleic acids and proteins
- + Screening tests

Features

- + High-purity polypropylene with very good chemical resistance
- + Optimal sample collection and mixture
- + Usable with multi-channel systems and in automation processes

User information

- Deep-well plates have a standardised ANSI/SLAS format which can be used in automated processes.
- The U-shaped base ensures optimal sample mixture and collection, the V-shaped base enables ideal sampling.
- The raised edges of the well allow for secure closure, protecting against contamination.
- The low-profile plate uses space efficiently with same well volume compared to standard plates. Use this plate for storage when you need to save as much space as possible.
- Barcodes can be applied to the sides for identification. These ensure clear classification and prevent mix-ups. An ordering form for adding barcodes is available:



Adhesive sealing films can also be used. Matching films are available on page 148 and in our online shop at shop.brand.de

Using sealing mats

Working volumes are reduced as follows when using sealing mats:

Deep-well plate [Cat. No.]	Material	Nominal volume [ml]	Max. filling volume with cover mat* [ml]	Sealing mat [Cat. No.]
701346	PP	0.5	0.44	701358
701350	PP	1.1	0.99	701360
701342	PP	1.2	0.97	701360
701340	PP (low profile)	1.1	0.85	701368
701354	PP	2.2	2.09	701362
701355	PP	0.3	0.25	701357

* approx. 2 mm space to the mat

Accessories

Sealing paddle

The sealing paddle helps to apply self-adhesive films. Thanks to its streamlined sides and rounded shape, it rests comfortably in your hand and ensures optimal force transfer. Pack of 2.



Cat. No. 701381

Ordering information for BRAND liquid handling equipment is provided at shop.brand.de





Technical information & Ordering data



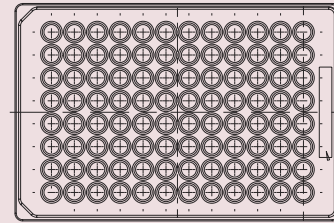

96-well deep-well plates made of PP

- Good chemical resistance, for example, to DMSO
- Use at -80 °C to 121 °C
- Autoclavable at 121 °C (2 bar), acc. DIN EN 285



96-well deep-well plates



Capacity	0.5 ml	1 ml	1.1 ml	1.1 ml
Plate	standard	Low Profile	standard	low profile
Well shape	round	square	round	round
Bottom	U-bottom 	U-bottom 	U-bottom 	U-bottom 
Height [mm]	28.5	24.45	40.6	27
Quality level	BIO-CERT® PCR QUALITY	CERTIFIED LIFE SCIENCE QUALITY	BIO-CERT® PCR QUALITY	CERTIFIED LIFE SCIENCE QUALITY
Pack of	48 pieces	50 pieces	24 pieces	50 pieces
Cat. No.	701346	701347	701350	701340

Cover mats for 96-well deep-well plates



For plate no.	701346	701347	701350	701340
Material	TPE	EVA	mod. PE	TPE
Autoclavable	yes	no	no	yes
Pack of	50 pieces	24 pieces	24 pieces	50 pieces
Cat. No.	701358	701362	701360	701368



Lids, PS for 96-well deep-well plates







For plate no.	701346	701340
Material	PS	PS
Quality level	CERTIFIED LIFE SCIENCE QUALITY	CERTIFIED LIFE SCIENCE QUALITY
Pack of	50 pieces	50 pieces
Cat. No.	782152	782152

Continued 96-well deep-well plates next page

Continued 96-well deep-well plates, PP

96-well deep-well plates

Capacity	1.2 ml	2.2 ml	2.2 ml	2.2 ml
Plate	elevated rim	standard	standard	standard
Well shape	round	square	square	square
Bottom	U-bottom	V-bottom	V-bottom	U-bottom
Height [mm]	41.4 	44.5 	44.0 	44.0 
Quality level	BIO-CERT® PCR QUALITY	CERTIFIED LIFE SCIENCE QUALITY	CERTIFIED LIFE SCIENCE QUALITY	BIO-CERT® PCR QUALITY
Pack of	32 pieces	50 pieces	30 pieces	24 pieces
Cat. No.	701342	701348	701353	701354

Cover mats for 96-well deep-well plates

For plate no.	701342	701348	701354	701354
Material	mod. PE	EVA	EVA	EVA
Autoclavable	no	no	no	no
Pack of	24 pieces	24 pieces	24 pieces	24 pieces
Cat. No.	701360	701362	701362	701362

Lids, PS for 96-well deep-well plates

For plate no.	701353	701354
Material	PS	PS
Quality level	CERTIFIED LIFE SCIENCE QUALITY	CERTIFIED LIFE SCIENCE QUALITY
Pack of	50 pieces	50 pieces
Cat. No.	782152	782152

 Matching sealing films are available in our online shop at shop.brand.de

384-well deep-well plates

- Usable with multi-channel systems and in automatic processes
- Usable down to -80 °C



384-well deep-well plates



Capacity	0.3 ml
Well-shape	square
Bottom	V-bottom
Height [mm]	30.2 
Quality level	BIO-CERT® CERTIFIED QUALITY
Pack of	48 pieces
Cat. No.	701355



Cover mats for 384-well deep-well plates



For plate no.	701355
Material	silicone
Autoclavable	yes
Quality level	BIO-CERT® CERTIFIED QUALITY
Pack of	50 pieces
Cat. No.	701357

Sealing films for 96-well and 384-well plates made of PP

- Temperature stable down to -80 °C
- Tight seal to minimize evaporation
- Remove without residue to easily access samples

Sealing films



Material	Aluminum	Aluminum	Polypropylene
Features	aluminum film can be punctured for easy collection	film strips for 96-well plates	film for PCR and storage
Temperature range	-80 °C to 120 °C	-80 °C to 120 °C	-80 °C to 120 °C
Pack of	100 pieces	300 strips (50 sheets of 6 strips)	100 pieces
Cat. No.	781381	781382	701367



Material	PET	Aluminium
Features	removable PET film for easy collection	removable aluminum film can be punctured
Temperature range	-80 °C to 120 °C	-80 °C to 120 °C
Pack of	100 pieces	100 pieces
Cat. No.	701376	701377



9.6 Tube racks



- ✓ Temperature resistant down to -80°C
- ✓ Individually removable tubes
- ✓ Tubes and racks can be autoclaved in accordance with DIN EN 285 at 121°C (2 bar)

Tube racks and racked-packed tubes offer a tight seal and compact storage format, as well as the option to remove individual vessels, helping to prevent unnecessary temperature fluctuations. In addition, they can also be used when working with multi-channel or automated systems.

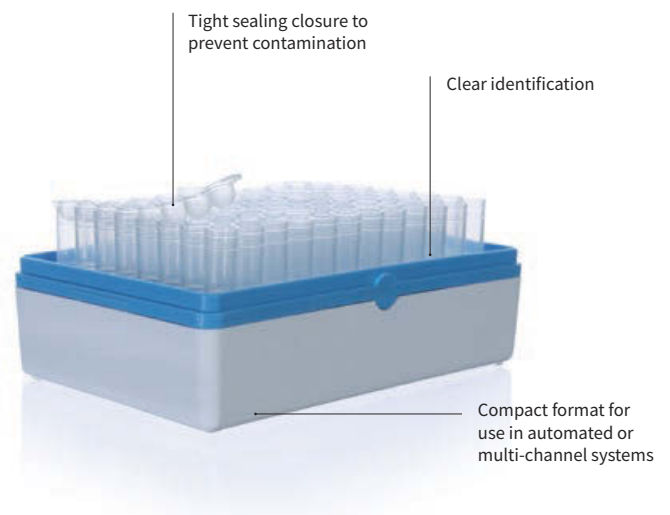

Applications

- + Storage of microorganisms
- + Creating databases
- + Cell growth studies
- + Storing and transporting reagents
- + PCR, RIA or EIA

Features

- + Tight sealing closure options
- + Vessel labelling for easy identification
- + Transparency for simple sample checks
- + Autoclavable at 121°C (2 bar), acc. DIN 285

Technical information & Ordering data

96 tube racks, non-sterile, for use with robots

- Tubes in the rack can be labelled individually, with caps
- Bar codes can be added
- Autoclavable at 121 °C (2 bar), acc. DIN EN 285

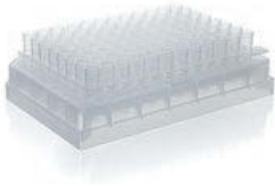
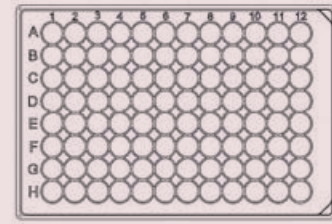

96 tube racks with lid, non-sterile, for use with robots

Capacity	0.65 ml	1.2 ml
Material	PP	PP
Pack of	50 pieces	50 pieces
Cat. No.	781565	781566

Tubes 1.2 ml rack-packed, non-sterile

- Tight sealing cap strips and caps
- Usable with multi-channel systems
- Tubes and racks are autoclavable at 121 °C (2 bar), acc. DIN EN 285 (caps, PE, are not autoclavable).

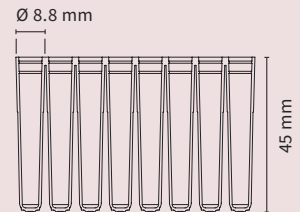

Complete racks with tubes (caps available as accessory)



Description	Rack with 96 individual tubes	Rack with 12 strips of 8 tubes
Material	PP	PP
Pack of	10 pieces	10 pieces
Cat. No.	781500	781510

Replacement tubes



Description	Individual tubes	Strip of 8 tubes
Material	PP	PP
Pack of	960 pieces	120 pieces
Cat. No.	781520	781525

Caps



Description	Individual caps	Strip of 8 caps
Material	PE	PE
Pack of	960 pieces	120 pieces
Cat. No.	781530	781535



Rack with grid, empty

Material	PP
Pack of	10 pieces
Cat. No.	781540



10. Sample storage down to $-196\text{ }^{\circ}\text{C}$

Creating gene databases or long-term storage of valuable cells and microorganisms requires reliable storage options and places high demands on storage containers.

To prevent chemical reactions and avoid sample degradation, most samples are stored in the gas phase of liquid nitrogen at $-196\text{ }^{\circ}\text{C}$. In order to use this method, vessels must be able to handle extreme temperature fluctuations, have a long-lasting seal, and retain their properties over a long period of time.

BRAND offers microtubes with screw caps and silicone seals, and specialized cryogenic tubes that provide safe and reliable long-term storage.

In addition, a large, frosted marking area and colored caps ensure easy identification and durable, legible labeling.

10.1 Microtubes with screw cap and silicone seal



- ✓ Excellent seal reliability
- ✓ Fast opening and closing with 1¼ turn of cap
- ✓ High purity polypropylene

Microtubes with screw caps with silicone seals are available with different base shapes to offer greater flexibility. They seal tightly and reliably and are an excellent choice for securely storing expensive reagents. Microtubes with screw caps with silicone seals are also a secure choice for interim storage of prepared formulations to be used in later testing.



Application

- + Aliquoting reagents
- + Storage of expensive samples
- + Storage of medical materials, such as serums or blood samples
- + Preparing formulations

Features

- + All tubes are made of highly transparent polypropylene
- + Screw cap with silicone seal for secure closure
- + Variable base shape for convenience
- + Easy identification through color coding

User information

- Ideal for storing medical materials such as serums and blood samples, as well as for sample heating and centrifuging.
- The microtubes can be centrifuged up to 17,000 x g.

Caution: The relative centrifugal force (RCF) is dependent on the radius of the rotor and the speed (RPM) of the centrifuge.

General conversion formula:

$$g = RCF = ((U/min)/1000)^2 \cdot r \cdot 1.118$$

g-force: Gravitational acceleration

RCF: Relative centrifugal force
(corresponds to the g-force)

r: Rotation radius

U/min: Rotor revolutions per minute (speed)

- Microtubes are sealed extremely well with silicone seals, without contact between the sample and the sealing ring. The containers are suitable for the storage of samples in the gaseous (vapor) phase of liquid nitrogen.

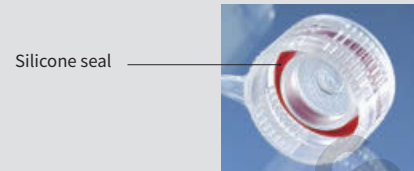

- The tamper-evident screw cap guarantees the user an uncontaminated sample. A visible ring acts as an anti-tamper seal, which breaks when the cap is first opened. The microtubes have a silicone seal, and are suitable for the storage of samples in the gaseous (vapor) phase of liquid nitrogen.

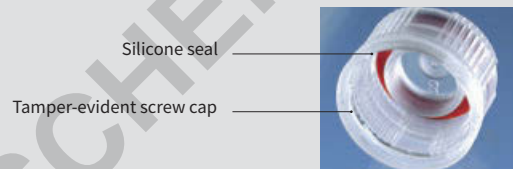

Self-standing tubes with a foot rim can easily be opened in the rack with one hand



Accessories

Cryogenic tube rack

For self-standing cryogenic tubes and tubes with screw cap. Pack of 4.

Cat. No. 114860



Microtube rack, PP

Stackable racks with alphanumeric positions. Operating temperature -20 °C to +90 °C. Autoclavable at 121 °C (2 bar), acc. DIN EN 285. Density 1.2 g/cm³. Will not float in waterbath. Pack of 5.



For Ø up to mm	Positions	white Cat. No.	blue Cat. No.	red Cat. No.
11	8 x 16	4341050	4341051	4341052
13	6 x 14	4341000	4341001	4341002

Mini cooler, PC

Durable polycarbonate filled with non-toxic gel. Mini coolers hold twelve 0.5 ml to 2.0 ml tubes. Pack of 1.



Bench temp. maintained	Time held	Color	Cat. No.
0 °C	60 min.	red	114930
-20 °C	60 min.	yellow	114935
-70 °C	45 min.	white	114940

Microtube rack, PP

Numbered positions for 20 microtubes, 1.5 ml. Autoclavable at 121 °C (2 bar), acc. DIN EN 285. Pack of 1.

Cat. No. 780605



Technical information & Ordering data

Microtubes with attached screw cap with silicone seal, non-sterile

- Easy handling due to attached lid
- For storage in gaseous phase of liquid nitrogen
- Operating range -196 °C to +121 °C
- Autoclavable at 121 °C (2 bar), acc. DIN EN 285



Attached screw cap with silicone seal, non-sterile

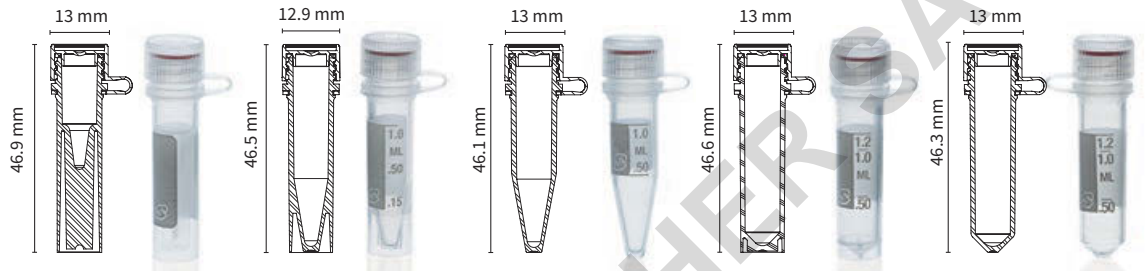

Capacity	0.5 ml	1.5 ml	1.5 ml	2 ml	2 ml
Subdiv. up to [ml]	-	1	1	1.2	1.4
Height [mm]	46.9	46.5	46.1	46.6	46.3
Description	self-standing	round-bottom	round-bottom	self-standing	round-bottom
Pack of	1000 pieces	1000 pieces	1000 pieces	1000 pieces	1000 pieces
Cat. No.	780710	780711	780712	780713	780714

Cap inserts for microtubes



Color	white	blue	red	green	yellow
Pack of	500 pieces	500 pieces	500 pieces	500 pieces	500 pieces
Cat. No.	780720	780721	780722	780723	780724





Microtubes with bulk screw cap with silicone seal, sterile

- High purity polypropylene, non-mutagenic, non-toxic
- Perfect cap seal to protect against evaporation
- Operating range -196 °C to +121 °C



Bulk screw cap
with silicone seal,
sterile

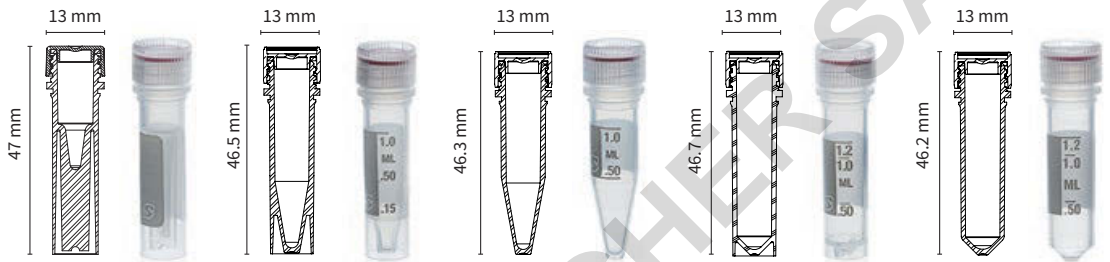

Capacity	0.5 ml	1.5 ml	1.5 ml	2 ml	2 ml
Height [mm]	47	46.5	46.3	46.7	46.2
Description	self-standing	self-standing	round-bottom	self-standing	round-bottom
Pack of	500 pieces	500 pieces	500 pieces	500 pieces	500 pieces
Cat. No.	780750	780751	780752	780753	780754

Cap inserts for
microtubes



Color	white	blue	red	green	yellow
Pack of	500 pieces	500 pieces	500 pieces	500 pieces	500 pieces
Cat. No.	780720	780721	780722	780723	780724



Screw caps for
microtubes



Color	white	blue	red	green	yellow
Pack of	1000 pieces	1000 pieces	1000 pieces	1000 pieces	1000 pieces
Cat. No.	780740	780741	780742	780743	780744

Microtubes with bulk tamper-evident screw cap with silicone seal, sterile

- The tamper-evident screw cap guarantees uncontaminated samples
- For storage in gaseous phase of liquid nitrogen
- Operating range -196 °C to +121 °C



Bulk tamper-evident screw cap with silicone seal, steril

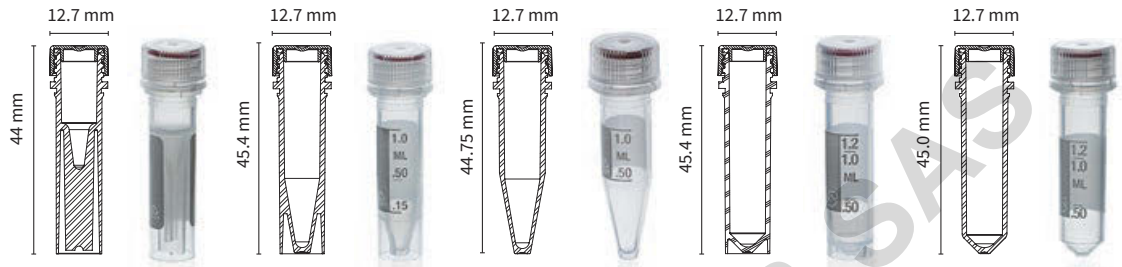

Capacity	0.5 ml	1.5 ml	1.5 ml	2 ml	2 ml
Height [mm]	44	45.4	44.75	45.4	45.0
Description	self-standing	self-standing	round-bottom	self-standing	round-bottom
Pack of	500 pieces	500 pieces	500 pieces	500 pieces	500 pieces
Cat. No.	780755	780756	780757	780758	780759

Microtubes without screw cap, non-sterile, ungraduated

- For storage in gaseous phase of liquid nitrogen
- Operating range -196 °C to +121 °C
- Autoclavable at 121 °C (2 bar), acc. DIN EN 285



Without screw cap, non-sterile, ungraduated

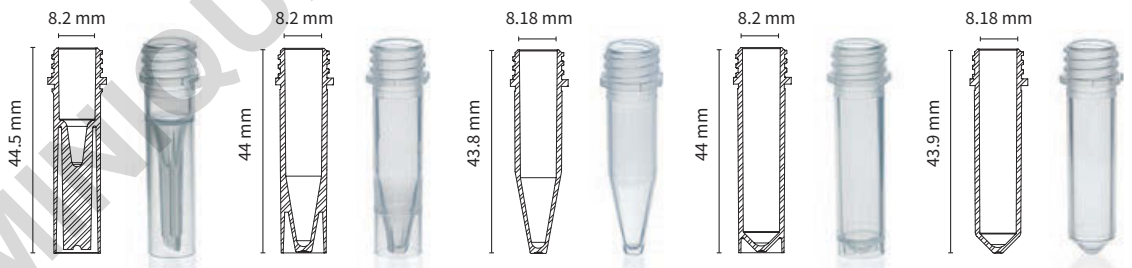

Capacity	0.5 ml	1.5 ml	1.5 ml	2 ml	2 ml
Height [mm]	44.5	44	43.8	44	43,9
Description	self-standing	self-standing	round-bottom	self-standing	round-bottom
Pack of	1000 pieces	1000 pieces	1000 pieces	1000 pieces	1000 pieces
Cat. No.	780760	780761	780762	780763	780764



Tamper-evident screw caps with silicone seal



Color	transparent	blue	green	purple	red	yellow
Pack of	1000 pieces	1000 pieces	1000 pieces	1000 pieces	1000 pieces	1000 pieces
Cat. No.	780770	780771	780772	780773	780774	780775



Microtubes without screw cap, non-sterile, graduated

- High purity polypropylene
- Operating range -196 °C to +121 °C
- Autoclavable at 121 °C (2 bar), acc. DIN EN 285



Without screw cap,
non-sterile,
graduated

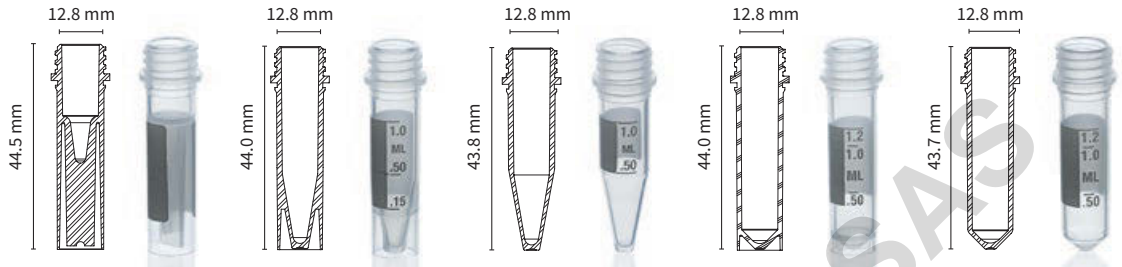

Capacity	0.5 ml	1.5 ml	1.5 ml	2 ml	2 ml
Height [mm]	44.5	44.0	43.8	44.0	43.7
Description	self-standing	self-standing	round-bottom	self-standing	round-bottom
Pack of	1000 pieces	1000 pieces	1000 pieces	1000 pieces	1000 pieces
Cat. No.	780730	780731	780732	780733	780734



Screw caps for
microtubes



Color	white	blue	red	green	yellow
Pack of	1000 pieces	1000 pieces	1000 pieces	1000 pieces	1000 pieces
Cat. No.	780740	780741	780742	780743	780744

10.2 Cryogenic tubes



- ✓ Safe long-term storage down to $-196\text{ }^{\circ}\text{C}$
- ✓ Tight sealed containers
- ✓ High purity polypropylene

Cryopreservation is an essential process for halting almost all chemical reactions during long-term storage and for preventing sample degradation. The most commonly used approach is to store samples in the gas phase of the liquid nitrogen tank, or in freezers. BRAND offers highly stable cryogenic tubes as an ideal choice for safe, long-term storage of biological materials. The right plastic and a precise thread design help perfectly seal these containers, reducing the danger of sample contamination.



Applications

- + Sample storage
- + Aliquoting and sample preparation
- + Extracting nucleic acids and proteins
- + Screening tests

Features

- + High-purity polypropylene with excellent chemical resistance
- + Tight-sealing and easy opening
- + Available in sizes 0.5 ml, 1.5 ml and 2.0 ml
- + Autoclavable at $121\text{ }^{\circ}\text{C}$ (2 bar), acc. DIN EN 285

User information

What does storage under cryogenic conditions mean?

Cryogenic conditions indicate temperatures below approx. -130°C (approx. $< 140\text{ K}$). This means the temperature is below the temperature at which water turns into a gas. Ice no longer recrystallises, and therefore there is no further growth of ice crystals (BURDEN 1999). This ensures that chemical processes in the samples are minimised, and that morphological changes (ie, ice crystal growth) are

prevented. When samples are stored in the gas phase in liquid nitrogen, the evaporating nitrogen in the sample storage container also creates an inert gas atmosphere that likewise generally prevents samples from changing due to oxygen from the ambient air (oxidation processes).

Examples of products stored under cryogenic conditions are:

- Sperm, egg cells
- Stem cells, bone marrow
- Blood components, such as erythrocytes
- Heart valves
- Skin, bones, teeth
- Samples for DNA analysis in genetic engineering.

Source: Dr. Heinz Rüdell, Martin Weingärtner, Fraunhofer Institute for Molecular Biology and Applied Oncology; Title: Lagerung von Umweltproben unter Cryobedingung; December 2008, V 2.0.0

For research use only!



Comparison of thread types



Advantages of external thread with sealing lid and silicone seal

- Simplifies single-handed operation in comparison to cryogenic tubes with internal thread.
- Reduces the danger of contamination.



Advantages of internal thread

- Space-saving compared to cryogenic tubes with external thread.
- Colored cap inserts snap in farther. Tubes can be removed from the box using the rod.
- Uniform exterior diameter improves fit with centrifuge rotors.



Technical information and ordering data for cryogenic tubes is available in chapter I "Cell culture" starting on page 22, and in our online shop at shop.brand.de



Correct sample storage

When choosing correct materials for different storage conditions, storage duration and temperature are key in addition to the sample to be stored. The lower the storage temperature required for safe storage, the greater the temperature fluctuations the vessel must withstand, as well as the closure especially when freezing and thawing the vessel.

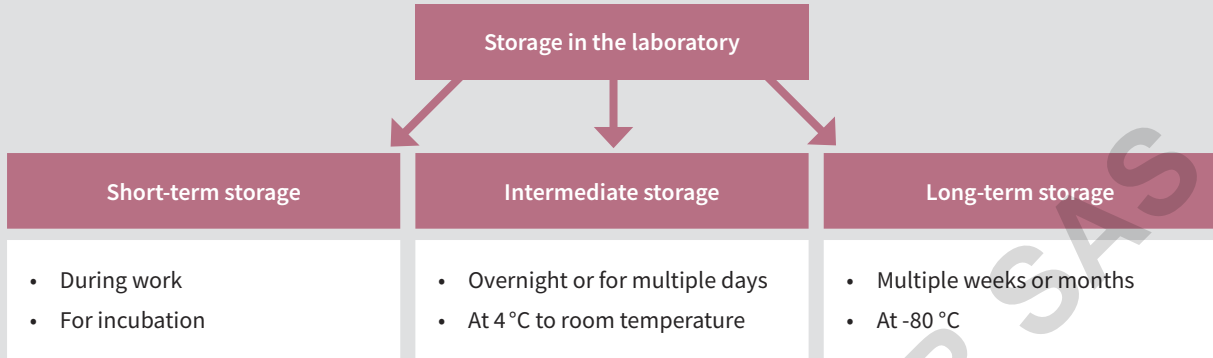

Repeated thawing and freezing may have a negative effect on the quality of your samples. We recommend creating aliquots and freezing these.

Storage down to -20 °C	Storage down to -80 °C	Storage down to -196 °C
<ul style="list-style-type: none"> • Short-term storage • Intermediate storage 	<ul style="list-style-type: none"> • Long-term storage of non-critical samples • Intermediate storage of sensitive samples 	<ul style="list-style-type: none"> • Databases • Storage of cell cultures • Long-term storage

Overview of different closure options for plates

	Lid	Sealing mats	Sealing films
Use	Easy closure for short-term storage . Caps offer only minor protection against evaporation.	For intermediate storage and protection during use. Good evaporation reduction.	For long-term storage . Films reduce evaporation to a minimum and offer long-term sealing for plates.
Evaporation protection	✓	✓✓	✓✓✓
Transparency	✓✓	-	-/✓✓
Simple handling	✓✓✓	✓✓	✓✓✓
Costs	✓✓✓	✓✓✓	✓✓

DOMINIQUE DUTSCHER SAS

DOMINIQUE DUTSCHER SAS

Trademark Index

accu-jet®, BIO-CERT®, BLAUBRAND®, BRAND®, BRAND. For lab. For life.®, BRANDplates®, cellGrade™, Dispensette®, hydroGrade™, immunoGrade™, inertGrade™, lipoGrade™, pureGrade™, seripettor®, Transferpette®, as well as the figurative marks depicted here and the BRAND figurative mark are registered trademarks or trademarks of BRAND GMBH + CO KG, Germany. The BRANDGROUP figurative mark is registered trademark or trademark of Brand Group SE & Co. KG, Germany.

All other trademarks mentioned or depicted here are the property of the respective owners.



Subject to technical modification without notice. Errors excepted.

DOMINIQUE DUTSCHER SAS

BRAND GMBH + CO KG

P.O. Box 1155 | 97861 Wertheim | Germany

T +49 9342 808 0 | info@brand.de | www.brand.de

BRAND. For lab. For life.®

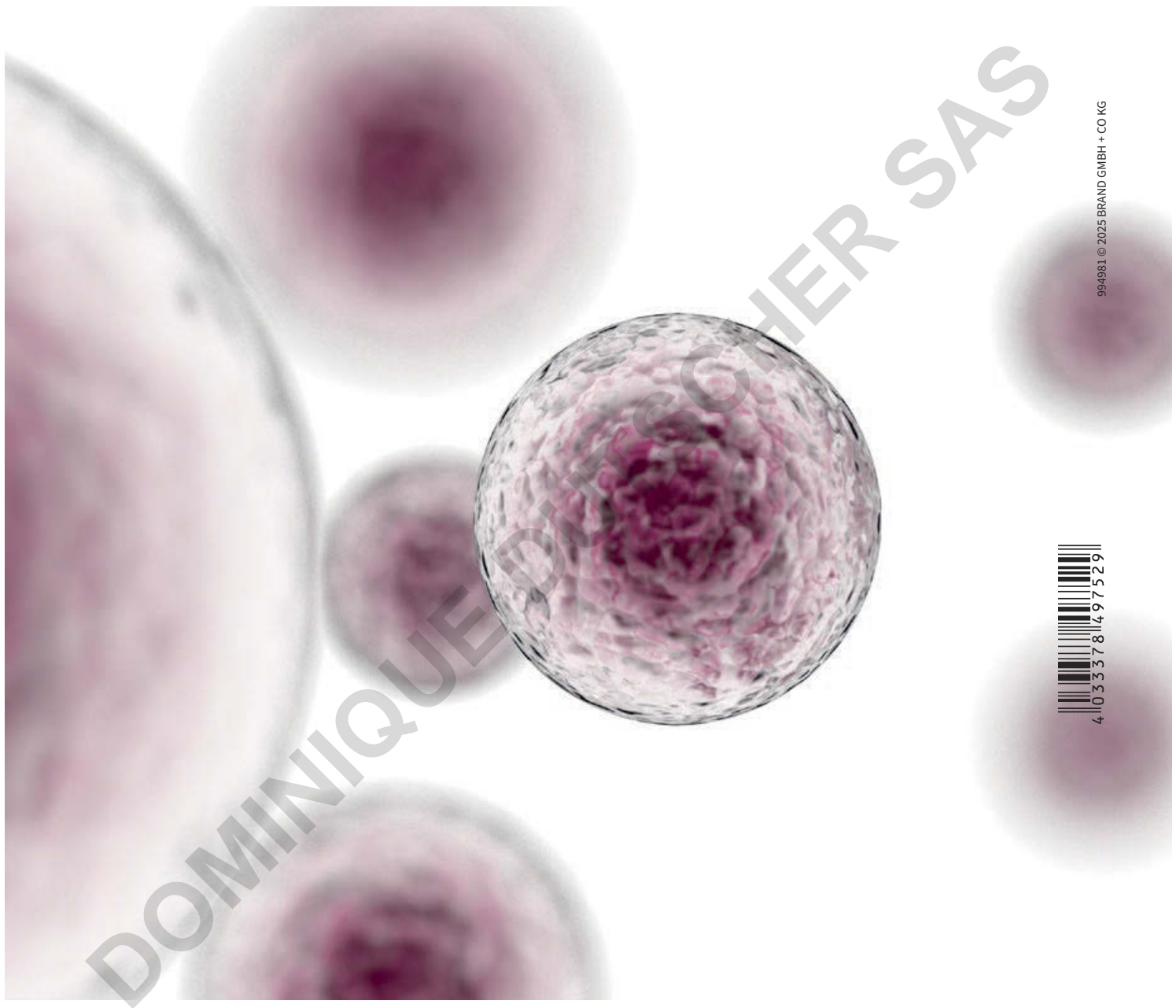

994981 © 2025 BRAND GMBH + CO KG

BRAND (Shanghai) Trading Co., Ltd.
Shanghai, China

T +86 21 6422 2318
info@brand.com.cn
china.brand.com.cn

BRAND Scientific Equipment Pvt. Ltd.
Mumbai, India

T +91 22 42957790
customersupport@brand.co.in
www.brand.co.in

BRANDTECH® Scientific, Inc.
Essex, CT. United States of America

T +1 860 767 2562
info@brandtech.com
www.brandtech.com