

**Grant-bio**

# **DNA/RNA UV-cleaner box UVT-S-AR**

*Operating instructions*



# Contents

---

1	<b>Safety.....</b>	<b>4</b>
2	<b>General Information.....</b>	<b>5</b>
3	<b>Getting Started.....</b>	<b>6</b>
4	<b>Operation of UVT-S-AR.....</b>	<b>7</b>
5	<b>Specifications.....</b>	<b>10</b>
6	<b>Guarantee and service.....</b>	<b>11</b>

# 1. Safety

---













The following symbols mean:



Caution: Read these operating instructions fully before use and pay particular attention to sections containing this symbol



Caution: Do not work in the box or with removed protective screen while the open UV-lamp is switched ON. Otherwise it can expose the operator to a dangerous level of UV light.

-  Use only as specified by the operating instructions, or the intrinsic protection may be impaired.
-  After transport or storage in humid conditions, dry out the unit before connecting it to the supply voltage. During drying out the intrinsic protection may be impaired.
-  Connect only to a power supply with a voltage corresponding to that on the serial number label.
-  Connect only to a power supply which provides a safety earth (ground) terminal.
-  Ensure that the mains switch and isolating device (power supply connector) are easily accessible during use.
-  Ensure that electrical appliances to be used inside the cabinet are inspected/tested for safety before use.
-  Total consumed power of devices connected via internal power sockets should not exceed 1000 W.
-  Before moving, disconnect at the power supply socket.
-  To disconnect the unit from the mains, disconnect the two-pin plug from the power socket.
-  Do not operate the unit outside the laboratory premises.
-  Do not operate the unit in premises with aggressive or explosive chemical mixtures.
-  Before using any cleaning or decontamination method except those recommended by the manufacturer, user should check with the manufacturer that the proposed method will not damage the equipment.

## 2. General Information

---

Bench-top DNA/RNA UV-cleaner box UVT-S-AR is designed for operation in laboratories working in the fields of DNA analysis, genetic engineering, molecular biology.

The UVT-S-AR is made of glass coated with UV-protecting film, the skeleton, the working surface and the rear side of stainless steel. The protective screen can be raised to one of three positions.

This model is designed for placement of laboratory instruments and accessories on the base work area. The total working area of the box is twice as large as that of the traditional model UVC/T-M-AR that allows more comfortable operation.

The UVT-S-AR has two open UV-lamps installed in the upper part of the box that disinfect the working area substantially decreasing contamination level during UV-exposure (15-30 min). White 30 W lamp provides local illumination of the working area and ensures good visibility during manipulations in the UV-cleaner box. The digital timer controls the UV-exposure time.

### **Advantages:**

- NO HEPA FILTERS
- OZONE FREE HIGH DENSITY UV DECONTAMINATION
- LONG LIVING UV LAMPS (AVERAGE 8000 HRS)
- AUTOMATIC OPEN UV-LAMPS SWITCH OFF WHEN THE PROTECTIVE SCREEN IS OPEN;
- NO NOISE, LOW ENERGY CONSUMPTION
- COMPACT "BENCH TOP" FOR PERSONAL LABS
- UV-RECIRCULATOR

The UVT-S-AR includes both traditional UV source for direct UV-exposure of the working area and an additional UV air flow cleaner (UV - recirculator) for biosafety DNA decontamination to protect the user from direct UV-light during operation.

UV-recirculator consists of a UV lamp, fan and dust filters organized in a special box, i.e. a person working in the UVT-S-AR is not exposed to UV-radiation and therefore processing the air-flow with UV-light can be performed practically all the time. UV-recirculator increases the density of UV-light to maximum raising the effectively the level of DNA inactivation.

# 3. Getting started

---

## 3.1 Unpacking

Carefully remove packaging materials, and retain for future shipment or storage of the unit.



*Caution!* Due to its size and weight (58 kg) the unit requires two people to lift or move it.

## 3.2 DNA/RNA UV Cleaner Box, UVT-S-AR set includes:

- DNA/RNA UV Cleaner Box, UVT-S-AR .....1 pce.
- A spare fuse .....2 pce.
- Specifications, Operating manual, CE Certificate .....1 pce.

## 3.3 Place UV-cleaner box on stable surface.



*Note!* Lifting or moving of the equipment requires two people. Ensure that tabletop (not less, then 1250x590 mm) and equipment is placed on solid, level surface, which is able to support it's weight.

## 4. Operation of UVT-S-AR

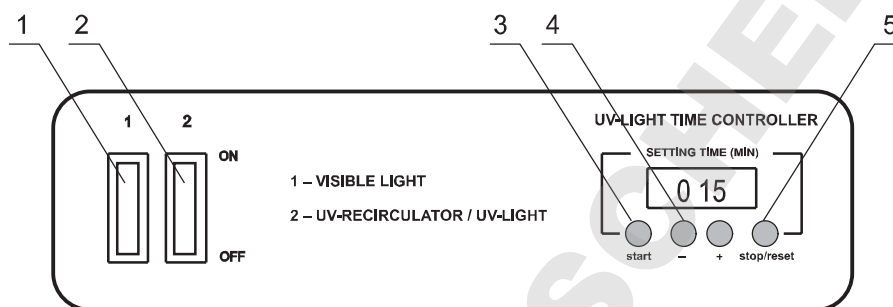

Fig.1. Control Panel

**4.1** Connect UV-cleaner box to a grounded (earthed) electrical power supply with voltage and frequency within the range specified on the serial number label.

**4.2 UV-exposition of the working place.**

Caution: Do not work in the box or with removed protective screen while the open UV-lamp is switched ON. Otherwise the operator will be exposed to dangerous levels of UV light.

**4.2.1** Switch ON the power switch located on the rear panel of the box.

**4.2.2** Turn ON *switch 2* (Fig.1/2). This automatically turns on the UV-recirculator with the hidden UV-lamp and activates the timer of open UV-lamp. The UV-recirculator will operate all the time until *switch 2* is turned OFF.

**4.2.3** Use the timer keys + and - (Fig.1/4) to set the time of direct UV light exposition of the working place:

(+) to increase exposition time (step 1 min)

(-) to decrease exposition time (step 1 min)

Recommended time of exposition 15-20 min.

**4.2.4** Press the key *Start* (Fig.1/3), the open UV lamp automatically will be turned ON and timer starts counting up the exposition time.

After reaching the set time the timer will automatically turn off the open UV-lamp.

Note: The open UV-lamp can be switched off immediately by pressing *Stop/Reset* key (Fig.1/5). The set time of exposition is preserved in the memory. (The set time won't be preserved after the complete switching off the UV-cleaner box).

UV-cleaner box is ready for use.



*Note!* the open UV-light is switched off when the protective screen is open (timer does not stop automatically).

### 4.3 Work in the Box

- 4.3.1 Turn ON *switch 1* (Fig.1/1) for lighting of the working place (this turns ON the white lamp).
- 4.3.2 Open the protection screen up for work in the box.
- 4.3.3 After the task is done close the screen.
- 4.3.4 At the end of work turn OFF *switch 2* (turns OFF the UV-recirculator) and *switch 1* (the white light OFF).
- 4.3.5 Turn OFF the power switch at the rear panel. Disconnect the mains power supply.

# 5. Specifications

- UV-recirculator .....TUV 30 W
- Direct UV-lamp light 2 x TUV 30 W, (Philips) bactericidal (long life - 8000hr on average)
- Radiation type.....Ultraviolet (253,7 nm), ozonefree
- Visible light lamp .....1xTLD-30 W
- Glass type .....Euroglass (Germany)
- Thickness of glass
  - sides .....4 mm
  - upper front panel.....8 mm
  - lower front panel .....5 mm
- UV-protection film type .....4 MIL CLEAR
- Optical transmission .....95%
- UV protection .....96%
- LED time controller of UV-exposure .....0 - 24 h/non-stop
- Working place.....1200x520 mm
- Overall size .....1245x585x585 mm
- Power .....230V, 50Hz, or 120V, 60Hz
- Consumed Power .....460W
- Weight, not more .....58 kg
- Operating conditions

The product is designed for operation in closed laboratory rooms at ambient temperature from +5°C to +40°C and maximum relative humidity 80% for temperatures up to 31°C decreasing linearly to 50% relative humidity at 40°C.



Total consumed power of devices connected via internal power sockets should not exceed 1000 W.

## 6. Guarantee and Service

### 6.1 Guarantee

When used in laboratory conditions and in accordance with the instructions provided, this product is guaranteed for TWO YEARS against faulty materials or workmanship (excludes UV-lamps and dust filters).

### 6.2 Service

There are no user-serviceable parts inside the unit. For all maintenance and repairs (except as defined below) return to our service department in the UK or in other countries, our distributor.

### 6.3 Technical Maintenance

*Replacement of fuses.* Disconnect the device from the mains power supply. Open the fuse holder (fig.2/A) located on rear side of the device by turning its cover anti-clockwise. Replace with the correct fuse. For 230V, 50Hz FU1 -6.3A  
FU2 -3.15 A

#### *Replacement of UV Lamps*

It is necessary to replace UV lamps at the end of manufacturer specified life time. Average life time of UV lamps supplied is 8000 hrs. To remove a bulb, switch off and disconnect the cabinet at the wall outlet. Unscrew the two screws on the sides of the upper screen (fig.2/B) and tilt the screen to release access to the bulb. Remove the bulb by rotating it until it comes free and can be slid out of the holders at each end.

Bulbs must be replaced with the same type and rating. To replace a bulb, carefully slide the pins on the end of the bulb into the slots in the holders and then rotate until they latch (a small click is usually heard). Access to the bulb in the recirculator can be gained by undoing the two knurled screws on the recirculator cover and removing the cover.

#### *How to verify the UV light output of the cabinet*

Because the UV bulbs in these cabinets are line emitters it is not necessary to use a spectrophotometer; a radiometer/sensor designed to measure 254nm wavelength UV radiation (such as UV Products UVX radiometer with a UVX-25 Sensor) will not only provide a valid reading but will also simplify the measurement process.

Having prepared the radiometer in accordance with the manufacturer's instructions, place the sensor on the base of the cabinet in the middle of the working area with the sensor window facing up. Close the cabinet hatch being careful not to crush the sensor cable. Switch on the direct UV lighting allowing for at least 15 minutes of operation.

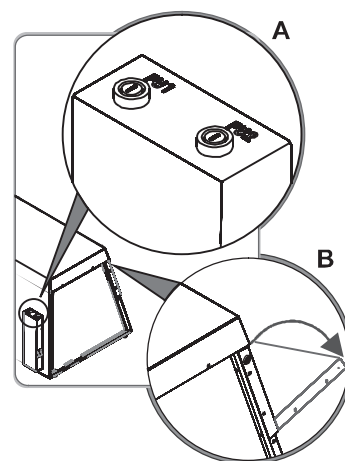

Fig.2.

---

Observe the Irradiance reading on the radiometer – it will usually double in a period of around 5 minutes. When the reading is stable record the measurement and compare with the table below. If it is below the minimum value the bulb must be replaced. Replacing the starter at the same time is not essential but is a good idea to ensure reliable operation.

To measure the UV output of the airflow cleaner, isolate from the mains, remove the 2 direct illumination UV bulbs and the cover over the recirculator which is held by 2 knurled screws. Using the radiometer with the sensor placed as before and the hatch on the cabinet shut, reconnect and switch on. Again leave the unit on for 5 minutes or until the reading is stable before making a measurement. Compare with the figure in the table below. If it is below the minimum value the bulb must be replaced. Replacing the starter at the same time is not essential but is a good idea to ensure reliable operation.

<b>BULB</b>	<b>Minimum values</b>	<b>Typical values</b>
2 x direct lighting UV bulbs	800 $\mu$ W/cm <sup>2</sup>	1200 $\mu$ W/cm <sup>2</sup>
1 x recirculator UV bulb	400 $\mu$ W/cm <sup>2</sup>	700 $\mu$ W/cm <sup>2</sup>

Isolate the equipment from the mains before removing/refitting bulbs, starters and the recirculator cover.

#### **6.4 Disinfecting**

For decontamination we recommend using a DNA/RNA removal solution (e.g. DNA-Exitus Plus™, RNase-Exitus Plus™). After cleaning ensure all internal surfaces are thoroughly dried.

#### **6.5 Routine safety tests**

If routine tests are to be made, we recommend a test of the integrity of the protective earth conductor and an insulation test at 500 Vdc. Routine flash tests are not recommended for any electrical equipment, because repeated high voltage tests degrade insulation materials.

#### **6.6 Replacement of Dust Filters**

The dust filters on either end of the UV-recirculator with the hidden UV-lamp should be checked monthly and cleaned or replaced when they become clogged. To check/replace the filter, simply unclip the cover fit a new filter and clip it back in place.

# Declaration of Conformity

Manufacturer:	BIOSAN LTD. Ratsupites 7, build.2, Riga, LV-1067, Latvia
Equipment name/type number:	UVT-S-AR
Description of Equipment:	DNA/RNA UV-cleaner box
Directives:	EMC Directive 2004/108/EC Low Voltage Directive 2006/95/EC

Applied Standards	
Harmonized Standards:	<u>EN 61326-1:</u> Electrical equipment for measurement, Control and laboratory use - EMC requirements Part 1: General requirements  <u>EN 61010:</u> Safety requirements for electrical equipment for measurement, control and laboratory use.

I declare that this apparatus conforms to the requirements of the above Directive(s)

  
Svetlana Bankovska  
Executive Director  
Biosan Ltd.

Dated 31.01.2011

# Grant-bio

**Grant Instruments  
(Cambridge) Ltd**  
Shepreth,  
Cambridgeshire  
SG8 6GB

Tel: +44 (0)1763 260811  
[www.grant.co.uk](http://www.grant.co.uk)  
[sales@grant.co.uk](mailto:sales@grant.co.uk)  
Fax: +44 (0)1763 262410

UV-cleaner/UVT-S-AR/28719/7