

Panasonic[®]

Operating Instructions Versatile Environmental Test Chamber

MLR-352

MLR-352H

MLR-352

MLR-352H Series



Please read these instructions carefully before using this product, and save this operating instructions for future use.

See page 63 for all model numbers.

CONTENTS

INTRODUCTION	P. 3
PRECAUTIONS FOR SAFE OPERATION	P. 4
ENVIRONMENTAL CONDITIONS	P. 7
CHAMBER COMPONENTS	P. 8
Switch box	P. 11
Control panel	P. 12
Remote record terminal	P. 13
Remote alarm terminal	P. 14
INSTALLATION SITE	P. 15
Caution for installation environment	P. 16
INSTALLATION	P. 17
BEFORE COMMENCING OPERATION	
Installing inner attachments	P. 19
PREVENTING CONTAMINATION	P. 20
TOP SCREEN	P. 21
FUNCTIONS THROUGH CONTROL PANEL	P. 22
STANBY OPERATION (MENU/Std-by)	P. 23
SETTING OF KEY LOCK (MENU/Std-by)	
Setting of Key Lock (Key Lock)	P. 24
Setting of Key Unlock (Key Unlock)	P. 25
HIGH LIMIT/LOW LIMIT ALARM (MENU/Std-by)	P. 26
PROGRAMMING (MENU/Edit)	P. 27
EDIT OF SAVED PROGRAM (MENU/Edit)	P. 33
START OF PROGRAM (MENU/Run)	P. 34
JOIN FUNCTION	P. 36
SKIP OF STEP (MENU/Skip)	P. 37
STOP OF PROGRAM (MENU/Stop)	P. 38
AUTOMATIC DEFROST (MENU/Tools/Date Time)	P. 39
MANUAL DEFROST (MENU/M.def)	P. 40
VARIOUS SETTING (MENU/Tools)	P. 41
Display of log (Tools/Log)	P. 41
Setting of date, time, log (Tools/Date Time)	P. 43
Alarm setting (Tools/Alarm Setting)	P. 44
Key lock password setting (Tools/Key Lock PW Setting)	P. 45
Default setting (Tools/Default Setting)	P. 46
Delete of program (Tools/Delete User Data)	P. 47
LIGHT STEP (ILLUMINANCE SETTING)	P. 49
HUMIDITY CONTROL (MLR-352H ONLY)	P. 50

CONTENTS

ROUTINE MAINTENANCE	P. 51
Cleaning of unit	P. 51
Replacement of fluorescent lamp	P. 51
Cleaning of evaporating tray	P. 52
Cleaning of filter	P. 52
ALARMS & SAFETY FUNCTIONS	
Automatic set temperature alarm	P. 53
Automatic set humidity alarm (MLR-352H only)	P. 53
Safety functions	P. 53
Operation after power failure	P. 53
TROUBLESHOOTING	P. 56
DISPOSAL OF UNIT	P. 57
PERFORMANCE DATA (MLR-352H)	P. 62
SPECIFICATIONS	P. 63
PERFORMANCE	P. 64
SAFETY CHECKSHEET	P. 65

INTRODUCTION

- Read this operating instructions carefully before using the Product and follow the instructions for safety operation.
- Our company disavows any responsibility for safety if the Product is used for other than the intended use or used with any procedures other than those given in this operating instructions.
- Keep this operating instructions in a suitable place so that it can be referred to as necessary.
- The contents of this operating instructions are subject to change without notice for improvement of performance or functions.
- Contact our sales representative or agent if any page of the operating instructions is lost or the page order is incorrect.
- Contact our sales representative or agent if any point in this operating instructions is unclear or if there are any inaccuracies.
- No part of this operating instructions may be reproduced in any form without the expressed written permission of our company.

CAUTION

Our company guarantees the product under certain warranty conditions. Our company in no way shall be responsible for any loss of content or damage of content.

Microsoft, Windows, Windows 7, Windows Vista, Windows XP and Windows 2000 are registered trademarks in the United States of Microsoft Corporation and various other countries.

PRECAUTIONS FOR SAFE OPERATION

It is imperative that the user complies with this operating instructions as it contains important safety advice.

Items and procedures are described so that you can use this unit correctly and safely. If the precautions advised are followed, this will prevent possible injury to the user and any other person.

Precautions are illustrated in the following way:



WARNING

Failure to observe WARNING signs could result in a hazard to personnel possibly resulting in serious injury or death.

CAUTION

Failure to observe CAUTION signs could result in injury to personnel and damage to the unit and associated property.

Symbol shows;

-  this symbol means caution.
-  this symbol means an action is prohibited.
-  this symbol means an instruction must be followed.

Be sure to keep this operating instructions in a place accessible to users of this unit.















< Label on the unit >



This mark is labeled on the cover in which the electrical components of high voltage are enclosed to prevent the electric shock.













The cover should be removed by a qualified engineer or a service personnel only.

WARNING







-  **Do not use the unit outdoors.** Current leakage or electric shock may result if the unit is exposed to rain water.
-  **Only qualified engineers or service personnel should install the unit.** The installation by unqualified personnel may cause electric shock or fire.
-  **Install the unit on a sturdy floor and take an adequate precaution to prevent the unit from turning over.** If the floor is not strong enough or the installation site is not adequate, this may result in injury from the unit falling or tipping over.
-  **Never install the unit in a humid place or a place where it is likely to be splashed by water.** Deterioration of the insulation may result which could cause current leakage or electric shock.
-  **Never install the unit in a flammable or volatile location.** This may cause explosion or fire.
-  **Never install the unit where acid or corrosive gases are present** as current leakage or electric shock may result due to corrosion.
-  **Always ground (earth) the unit to prevent electric shock.** If the power supply outlet is not grounded, it will be necessary to install a ground by qualified engineers.
-  **Never ground the unit through a gas pipe, water main, telephone line or lightning rod.** Such grounding may cause electric shock in the case of an incomplete circuit.
-  **Connect the unit to a power source as indicated on the rating label attached to the unit.** Use of any other voltage or frequency other than that on the rating label may cause fire or electric shock.
-  **Never store volatile or flammable substances** in this unit if the container cannot be sealed. These may cause explosion or fire.
-  **Do not insert metal objects such as a pin or a wire into any vent, gap or any outlet on the unit.** This may cause electric shock or injury by accidental contact with moving parts.
-  **Use this unit in safe area when treating the poison, harmful or radiate articles.** Improper use may cause bad effect on your health or environment.
-  **Turn off the power switch (if provided) and disconnect the power supply to the unit prior to any repair or maintenance** of the unit in order to prevent electric shock or injury.
-  **Do not touch any electrical parts (such as power supply plug) or operate switches with a wet hand.** This may cause electric shock.

PRECAUTIONS FOR SAFE OPERATION

WARNING

-  **Ensure you do not inhale or consume medication or aerosols** from around the unit at the time of maintenance. These may be harmful to your health.
-  **Never splash water directly onto the unit** as this may cause electric shock or short circuit.
-  **Never put containers with liquid on the unit** as this may cause electric shock or short circuit when the liquid is spilled.
-  **Never bind, process, or step on the power supply cord, or never damage or break the power supply plug.** A broken supply cord or plug may cause fire or electric shock.
-  **Do not use the supply cord if its plug is loose.** Such supply cord may cause fire or electric shock.
-  **Never disassemble, repair, or modify the unit yourself.** Any such work carried out by an unauthorized person may result in fire, or electric shock or injury due to a malfunction.
-  **Disconnect the power supply plug if there is something wrong with the unit.** Continued abnormal operation may cause electric shock or fire.
-  **When removing the plug from the power supply outlet, grip the power supply plug, not the cord.** Pulling the cord may result in electric shock or fire by short circuit.
-  **Disconnect the power supply plug** before moving the unit. Take care not to damage the power cord. A damaged cord may cause electric shock or fire.
-  **Disconnect the power plug when the unit is not used for long periods.** Keeping the connection may cause electric shock, current leakage, or fire due to the deterioration of insulation.
-  **If the unit is to be stored unused in an unsupervised area for an extended period, ensure that children do not have access and that doors cannot be closed completely.**
-  **The disposal of the unit should be accomplished by appropriate personnel.** Remove doors to prevent accidents such as suffocation.
-  **Do not put the packing plastic bag within reach of children** as suffocation may result.

CAUTION

-  This unit must be plugged into a dedicated circuit protected by branch circuit breaker.
-  Use a dedicated power source as indicated on the rating label attached to the unit. A multiple-tap may cause fire resulting from abnormal heating.
-  **Never store corrosive substances such as acid or alkali** in this unit if the container cannot be sealed. These may cause corrosion of inner components or electric parts.
-  **Check the setting when starting up of operation after power failure or turning off of power switch.** The stored items may be damaged due to the change of setting.
-  **Be careful not to tip over the unit** during movement to prevent damage or injury.
-  **Prepare a safety check sheet** (copy the last page) when you request any repair or maintenance for the safety of service personnel.
-  Need to put a safety device to the heat load side by a user when any apparatus is used in the chamber of this unit.

ENVIRONMENTAL CONDITIONS

This equipment is designed to be safe at least under the following conditions (based on the IEC 61010-1):

- Indoor use;
- Altitude up to 2000 m;
- Ambient temperature 5 °C to 40 °C
- Maximum relative humidity 80 % for temperature up to 31 °C decreasing linearly to 50 % relative humidity at 40 °C;
- Mains supply voltage fluctuations not to exceed ± 10 % of the nominal voltage;
- Other supply voltage fluctuations as stated by the manufacturer;
- Transient overvoltages according to Installation Categories (Overvoltage Categories) II; For mains supply the minimum and normal category is II;
- Pollution degree 2 in accordance with IEC 60664.

CHAMBER COMPONENTS

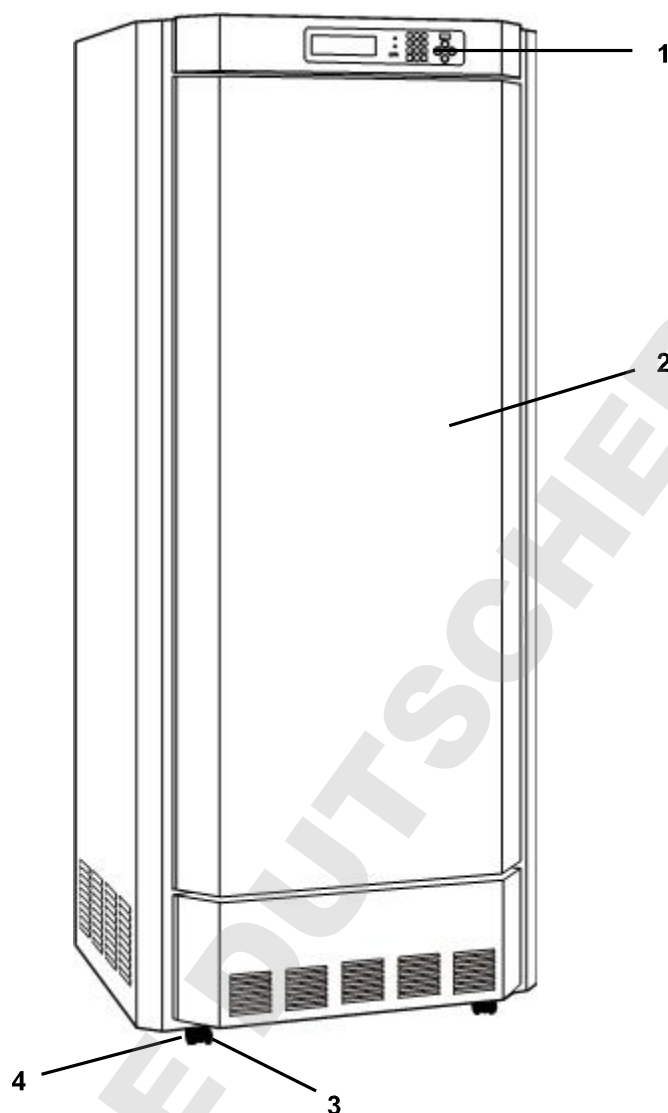

1. Control panel:

The control panel is used for setting temperature, humidity (MLR-352H only), light program and alarm. For the details, see page 12.

2. Door:

5 fluorescent lamps and 5 glow starters are attached inside the door. When the door is closed, it will be attached firmly to the body by a magnetic gasket.

WARNING

These fluorescent lamps are incorporated inside the door and side doors directly without cover. Do not damage the fluorescent lamps when open or close the doors and replace the fluorescent lamps.

3. Leveling foot:

To secure the unit, turn the leveling feet beside the casters counterclockwise until they rest securely on the floor.

4. Caster:

The 4 casters are used to move the unit. When installing the unit, suspend the front two casters using a leveling foot.

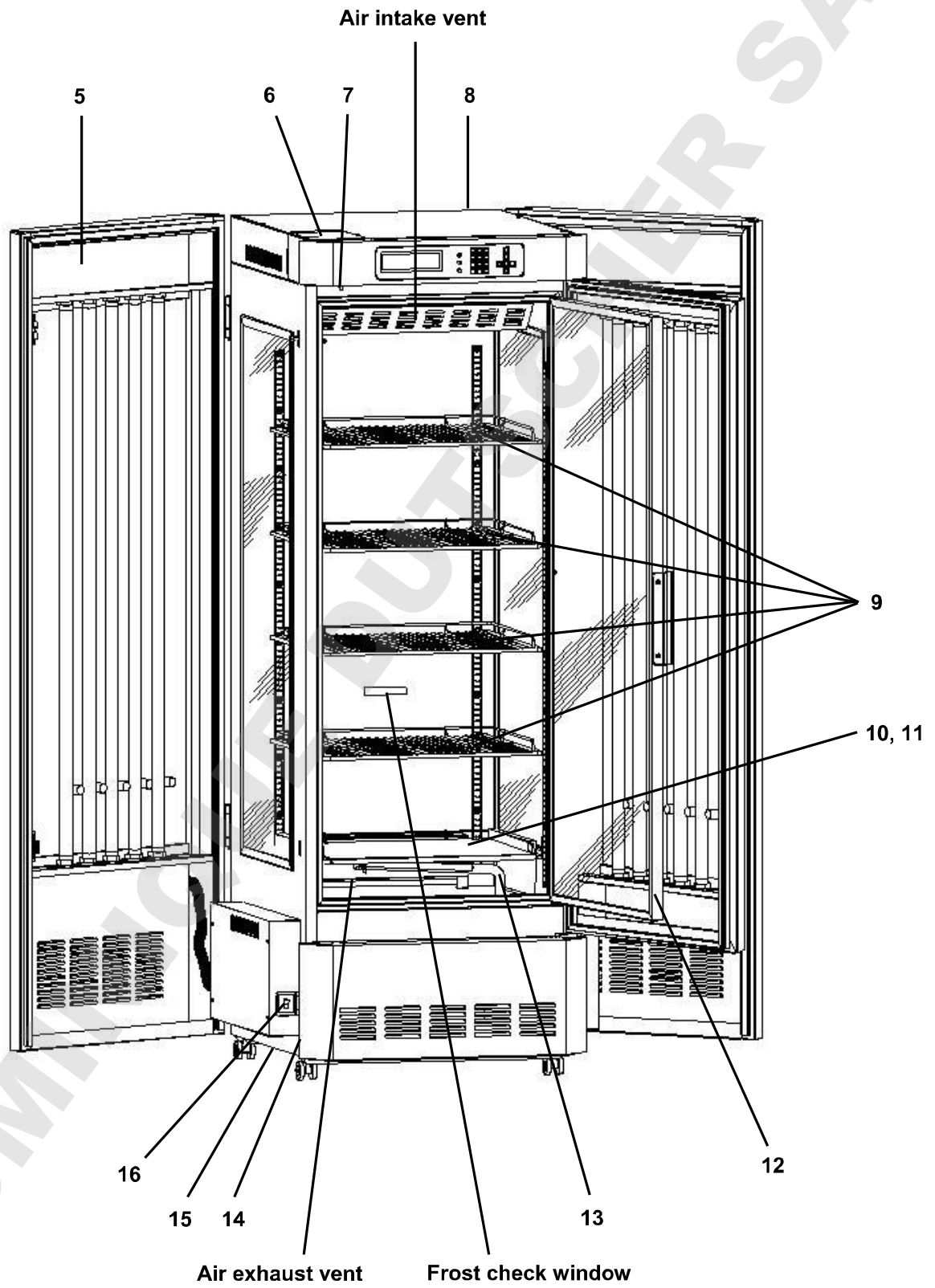

CHAMBER COMPONENTS

5. Side door:

5 fluorescent lamps and 5 glow starters are mounted inside of the side doors (right and left). Open the door to replace fluorescent lamps or glow starters.

6. **Switch box:** Refer to page 11.

7. **Door switch:** When the door is opened, the air circulation fan stops to minimize the leakage of cool air.

8. **Remote alarm terminal (Back side of the unit):** Refer to page 14.

9. **Upper shelves (4 pcs):** The 4 shelves other than the fifth one at the bottom. The shelf position can be adjusted vertically. Refer to page 19.

10. **Bottom Shelf (1 piece):** The fifth shelf at the bottom. Make sure to attach the air exhaust vent cover to the bottom shelf before using. Refer to page 19.

11. **Air exhaust vent cover:** Refer to page 19.

12. Inner door:

This glass inner door minimizes the leakage of cool air when the cabinet door is opened. The loss of cool air may cause fluctuation of chamber temperature.

Note: Be careful not to break glass.

13. **Humidifying duct (MLR-352H only):** Refer to page 19

14. **Filter:** Refer to page 52.

15. Evaporating tray:

The evaporating tray collects drain water and allows it to be evaporated. Before start to use the unit, set the evaporating tray on the rail, which extends from the left side of the frame at the bottom. (Fig. 1)

Note: Improper setting may result in spillage of water. In that case, wipe off water.

16. Power switch with circuit breaker:

This switch is for all electric sources. When the operation of the unit is stopped by this breaker, contact our sales representative or agent after disconnecting the power supply plug.

17. **Cap (MLR-352 only):** Always keep this cap on (Fig. 2).

18. **Water supply inlet (MLR-352H only):** Refer to page 18.

19. **Water supply tank (MLR-352H only):** Refer to page 18.

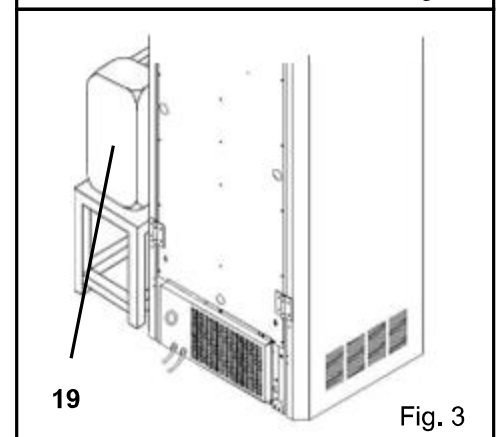
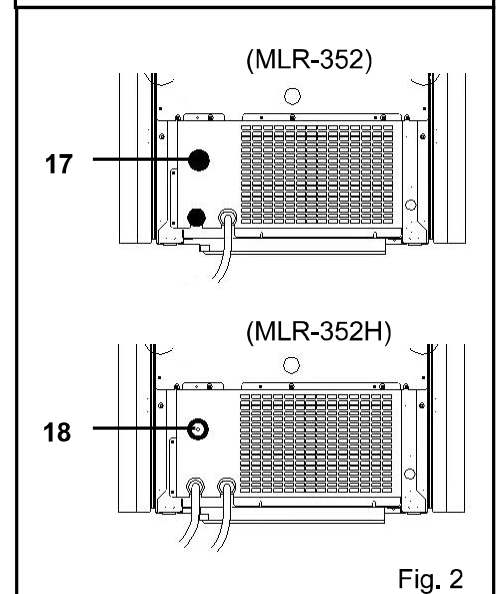
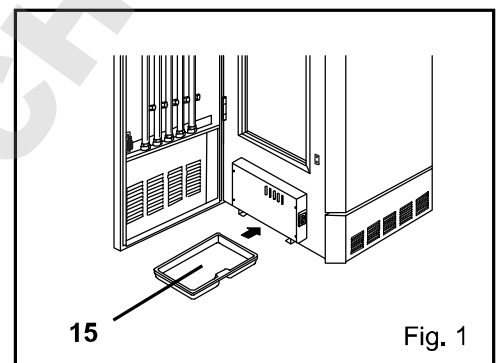

Switch box

Inside the switch box, there are the access port and the remote record terminal.

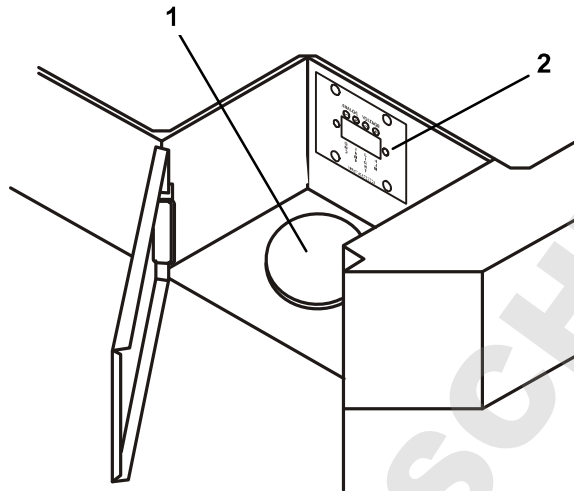

1. Access port

When an instrument that requires a measuring cable and power cord is placed inside the cabinet, the cable and cord can be led through this access port. When a cord is led through, use the cap to prevent air from coming in or out.

! CAUTION

Always plug the access port with the cap. Failure to plug the port may disturb the refrigerating performance or cause condensation outside the port.

2. Remote record terminal

Refer to "Remote record terminal" on page 13 for usage.

CHAMBER COMPONENTS

Control panel

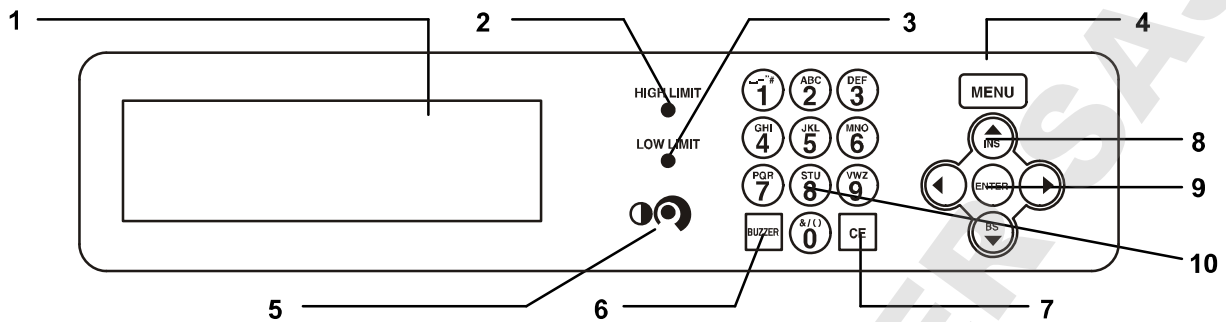

1. LCD panel

2. High limit temperature alarm volume (HIGH LIMIT)

To set the temperature of high limit temperature alarm.

3. Low limit temperature alarm volume (LOW LIMIT)

To set the temperature of low limit temperature alarm.

4. Menu button (MENU)

To open the menu window.

5. LCD contrast adjusting knob

To adjust the contrast of graphic LCD.

6. Alarm buzzer stop key (BUZZER)

To silence the alarm buzzer temporarily.

7. Clear key (CE)

To clear the input value during editing of program.

8. Shift key (Upward, downward, rightward, leftward)

To move the cursor on the LCD panel.

9. Enter key (ENTER)

To determine the selection of menu. In program editing, pressing this key causes moving to a next article.

10. Character input key

Remote record terminal

The terminal output of remote recorder is temperature(°C) 0 mV~100 mV, light step(LS) 0 mV~100 mV, relative humidity(%R.H.) 0 mV~100 mV. Please refer below for each control element.

Terminal

No.1	Common (-)
No.2	Temperature (°C) (+)
No.3	Light step (LS) (+)
No.4	Relative humidity (%R.H.) (+)

	Range	Output
Temperature	0 °C~50 °C	2 mV/°C
Light step	0LS~5LS	20 mV/LS
Relative humidity	0 %~100 %	1 mV/%R.H.

(Example)

Output of temperature 37 °C :

$$37\text{ °C} \times 2\text{ mV/°C} = 74\text{ mV}$$

Output of light step :

$$3\text{LS} \times 20\text{ mV/LS} = 60\text{ mV}$$

Output of relative humidity 80 %R.H. :

$$80\text{ %R.H.} \times 1\text{ mV/%R.H.} = 80\text{ mV}$$

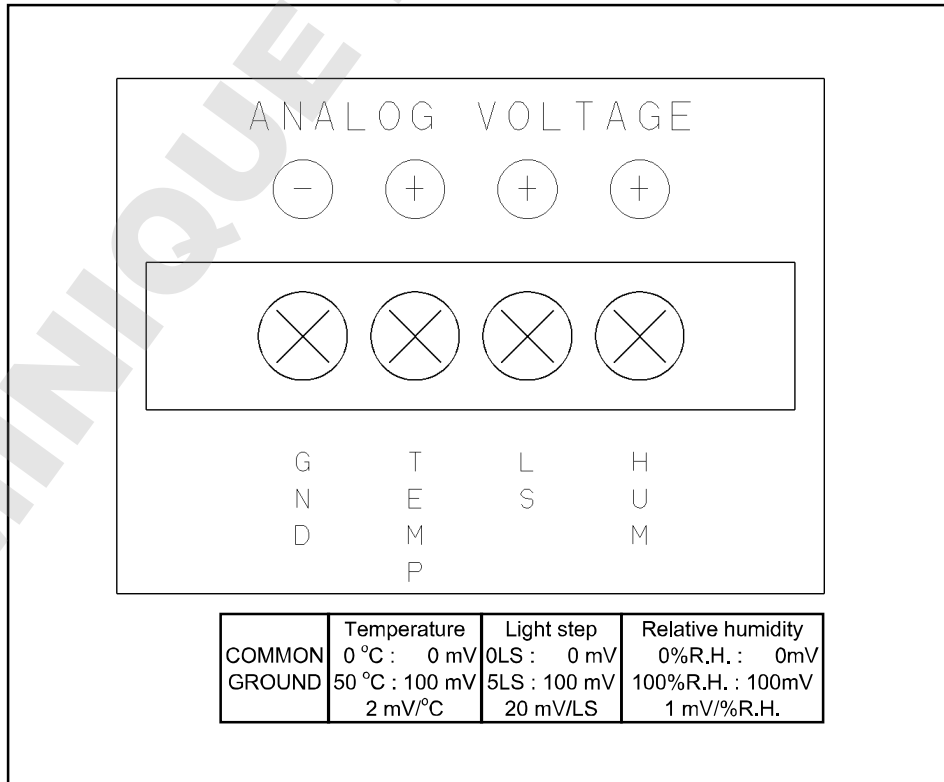

CHAMBER COMPONENTS

Remote alarm terminal

The terminal for the remote alarm is located in the data input/output port at the rear top of the frame (Refer to the figure below). To access the terminal, remove four screws on the rear frame by a screw driver and take out a cover.

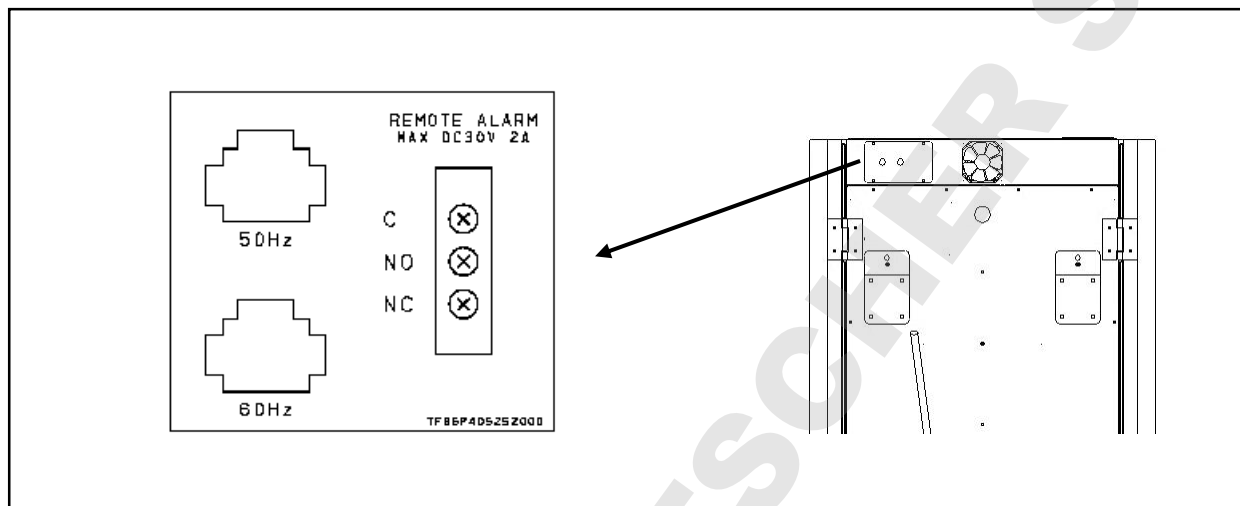

The remote alarm terminal is a contact output. Contact capacity is or 2 A (DC 30 V).

- 1) Output: Normal open, abnormal close; connect to C and N.O.
- 2) Output: Normal close, abnormal open; connect to C and N.C.

Power failure: C and N.O. terminal are closed.

INSTALLATION SITE

To operate this unit properly and to obtain maximum performance, install the unit in a location with the following conditions:

■ **A location not subjected to direct sunlight**

Do not install the unit under direct sunlight. Installation in a location subjected to direct sunlight cannot obtain the intended performance.

■ **A location with adequate ventilation**

Leave at least 10 cm around the unit for ventilation. Poor ventilation will result in a reduction of the performance and consequently the failure.

■ **A location away from heat generating sources**

Avoid installing the unit near heat-emitting appliances such as a heater or a boiler etc. Heat can decrease the intended performance of the unit.

■ **A location with little temperature change**

Install the unit under stable ambient temperature. The allowable ambient temperature is between 5 °C and 35 °C.

■ **A location with a sturdy and level floor**

Always install the unit on a sturdy and level floor. The uneven floor or tilted installation may cause failure or injury. Install the unit in stable condition to avoid the vibration or noise. Unstable condition may cause vibration or noise.

 **WARNING**

Install the unit on a sturdy floor. If the floor is not strong enough or the installation site is not adequate, this may result in injury from the unit falling or tipping over.

Select a level and sturdy floor for installation. This precaution will prevent the unit from tipping. Improper installation may result in water spillage or injury from the unit tipping over.

■ **A location not prone to high humidity**

Install the unit in the ambient of 80% R.H. or less humidity. Installation under high humidity may cause current leakage or electric shock.

 **WARNING**

Do not use the unit outdoors. Current leakage or electric shock may result if the unit is exposed to rain water.

Never install the unit in a humid place or a place where it is likely to be splashed by water. Deterioration of the insulation may result which could cause current leakage or electric shock.

■ **A location without flammable or corrosive gas**

Never install the unit in a flammable or volatile location. This may cause explosion or fire or may result in the current leakage or electric shock by the corrosion of the electrical components.

■ **A location without the possibility of anything fall**

Avoid installing the unit in the location where anything can fall down onto the unit. This may cause the breakdown or failure of the unit.

INSTALLATION SITE

Caution for installation environment

■ Suitable temperature range

The acceptable ambient temperature range for this chamber is 5 °C to 35 °C. Avoid operating the chamber with an ambient temperature lower than 5 °C. This may cause failure by freezing.

■ Location convenient for the water supply/drain (MLR-352H only)

MLR-352H needs water supply and drain. Select the location for easy access to supply/drain provision.

■ Caution for frost (In the case of pattern 1 for the automatic defrost.)

Operating the chamber with chamber temperature of lower than 10 °C (15 °C; for MLR-352H), accumulates frost on the evaporator. The cooling capacity is degraded and the chamber temperature rises when the evaporator is clogged by frost. Start the manual defrost when a lot of frost between cooling fins is found through the frost check window. For the manual defrost, see page 40. The frost is formed in short time when the article including much moisture is stored.

INSTALLATION

1. Removing the packaging materials and tapes

Remove all transportation packaging materials and tapes. Open the doors and ventilate the unit. If the outside panels are dirty, clean them with a diluted neutral dishwashing detergent. (Undiluted detergent can damage the plastic components. For the dilution, refer to the instruction of the detergent.) After the cleaning with the diluted detergent, always wipe it off with a wet cloth. Then wipe off the panels with a dry cloth.

Note:

Remove the cable tie banding the power supply cord. Prolonged banding may cause the corrosion of the cord coating.

2. Adjusting the leveling foot

Extend the leveling feet by turning them counterclockwise to contact with the floor. Ensure the unit is level. See Fig. 1.

3. Fixing the unit

Two fixtures are attached to the rear of the frame. See Fig. 2. Fix the frame to the wall with these fixtures and rope or chain.

4. Ground (earth)

The ground (earth) is for preventing the electric shock in the case of the electrical insulation is somehow degraded. Always ground the unit at the time of installation.

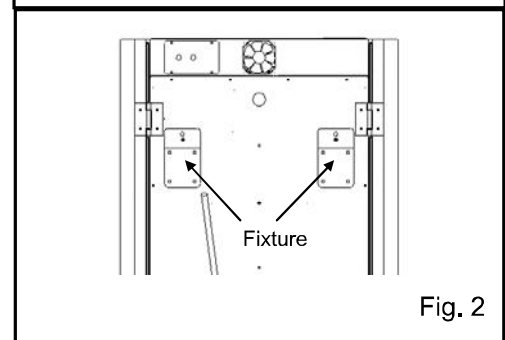
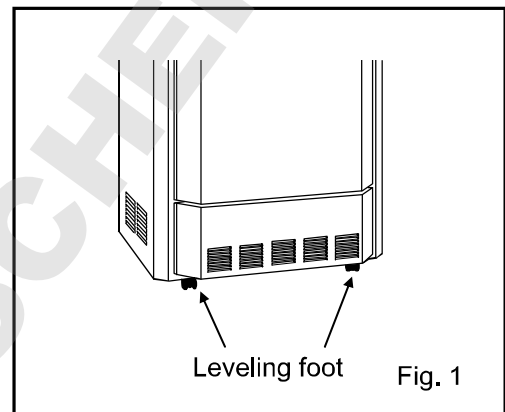

⚠️ WARNING

Use a power supply outlet with ground (earth) to prevent electric shock. If the power supply outlet is not grounded, it is necessary to install a ground by qualified engineers.

Never ground the unit through a gas pipe, water main, telephone line or lightning rod. Such grounding may cause electric shock in the case of an incomplete circuit.

⚠️ WARNING

In case of being obliged to install the unit near a watery or humid location, consult sales or representative or agents so that need to set a earth leakage breaker. Earth leakage may cause electric shock. (Use a specified earth leakage breaker.)

⚠️ WARNING

Do not put the packing plastic bag within reach of children as suffocation may result.

INSTALLATION

5. Remove tapes for preventing dropout of door and both ends of side fluorescent lamps.

6. Set the evaporating tray enclosed in the chamber under the unit from the left side of the unit. (See Fig. 1 on page 10)

7. Preparation of water supply (MLR-352H only)

- Fill the water supply tank with either ion exchange processed water or distilled water. The tank should be installed at a height of 50 cm or higher from the floor.
- Connect the water supply hose with one-touch joint between the tank outlet and water supply inlet on the unit.
- Open the tank cock.

8. Drain treatment

Arrange the drain hose (See Fig. 2 and 3) so that the water can be drained properly in the hose. Use a container for drained water if there is no suitable site for drainage around the unit. In this case, be sure to set the container inlet at lower position than the drain hose outlet.

Note:

The drain hose for cleaning is used only when cleaning the chamber. After cleaning the chamber with water, drain the water with this hose.

9. Connect the power supply cord to the appropriate power source, open the left side door and turn on the power switch.

Note: Open the inner door to ventilate the chamber before starting operation.

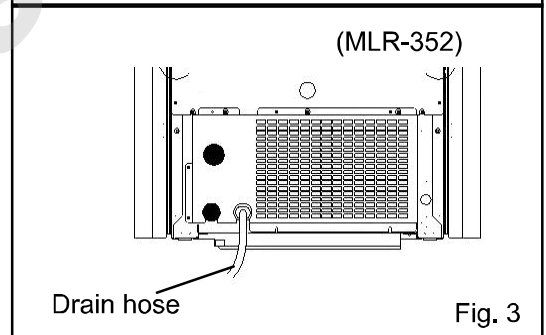
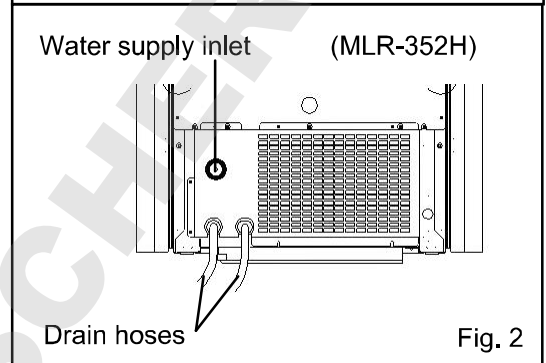
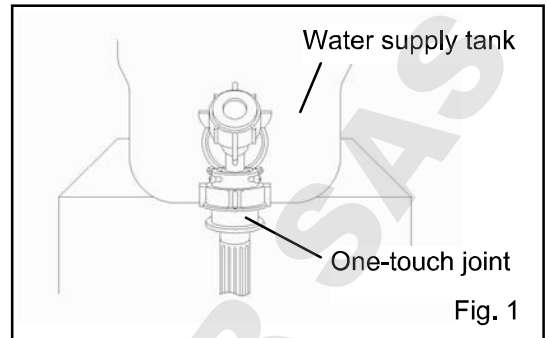

⚠ CAUTION

MLR-352H requires a water supply. The enclosed water supply tank supplies water by gravity, and should be installed at height of 50 cm or more. Never place the water supply tank on top of this unit. The water supply tank should be filled with either ion exchange processed water or distilled water. Never connect the water main to the unit directly. The water level can be checked from the side of the water supply tank. Ensure the water supply tank doesn't become empty during the operation with humidity. (Only MLR-352H)

BEFORE COMMENCING OPERATION

Installing inner attachments

1. Shelves setting

The 4 upper shelves (except the fifth one at the bottom) can be adjusted to desired height. To adjust the height, insert self-support clips (4 per shelf) into the slots at the desired height (Fig. 1). However the self-support clips for the bottom shelf should be inserted into the 4th and the 5th long hole counting from the lowest one, and their position should not be changed (Fig. 2).

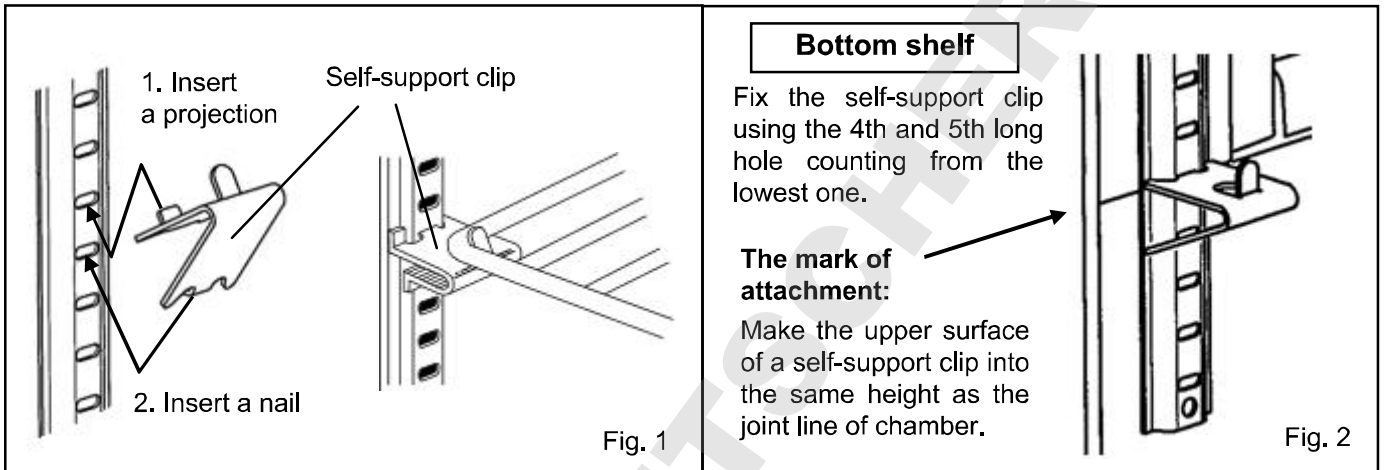

2. Air exhaust vent cover setting

Cover the bottom shelf with the air exhaust vent cover. Make sure the air exhaust vent cover is horizontally placed by matching the cuts on the cover with the ledge on the bottom shelf. (Fig. 3).

Note:

- Make sure to attach the air exhaust vent cover to the bottom shelf. Operation without the air exhaust vent cover will worsen the temperature distribution in the chamber.
- (MLR-352H only) Set the humidifying duct to the stopper of bottom shelf in order to uniform the inside temperature (Fig. 4).

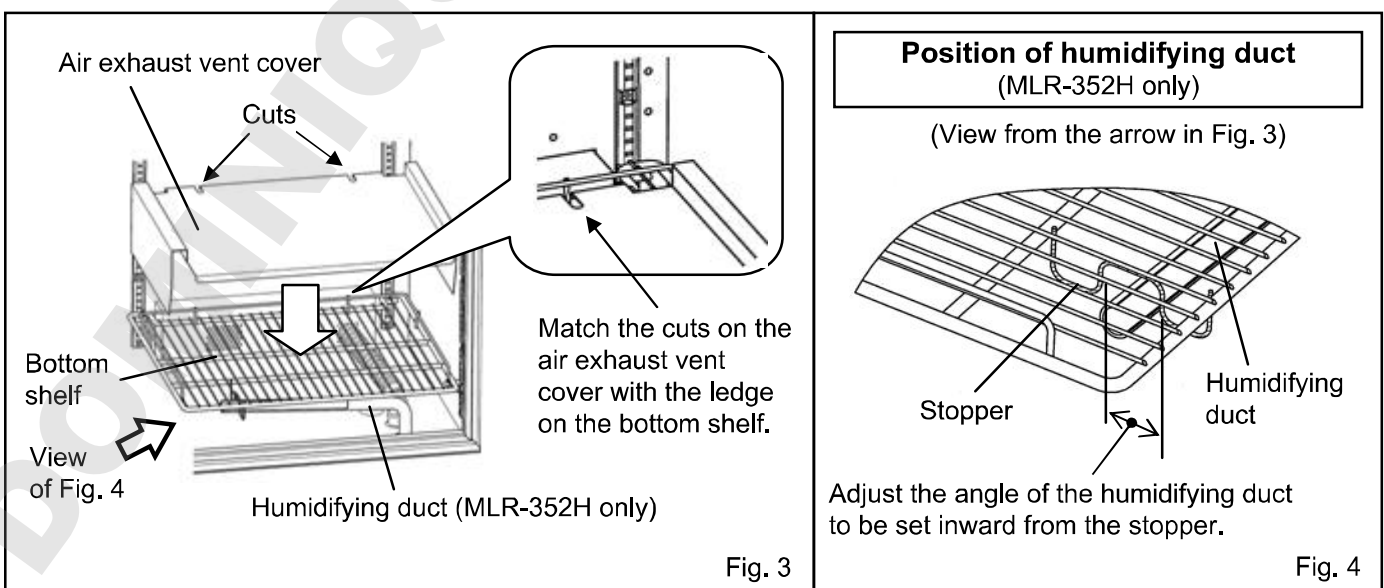

BEFORE COMMENCING OPERATION

CAUTION

The chamber temperature is controlled by the forced air circulation. Do not block the air intake vent and air exhaust vent with the stored items or equipment. Blocking of these vents may cause unstable chamber temperature.

CAUTION

Never store acid, alkali or corrosive gas in this unit if the container cannot be sealed. These may cause breakdown due to discoloration or corrosion.

Never store volatile or inflammability chemicals such as ether, benzene, alcohol, propane gas, adhesive. These may cause explosion or fire.

CAUTION

When the unit is not used, remove the moisture in the chamber completely. Check the chamber is completely dry before closing the doors. Remained moisture may cause condensation resulting in the failure of the unit.

PREVENTING CONTAMINATION

To prevent contamination of the chamber, select an appropriate location for installation as well as the complete disinfection of the chamber components.

■ Avoid hot and humid location

Avoid location with high temperature and/or humidity as the presence of bacteria in the air is greater than in normal environment.

■ Avoid drafty location and location with many passers-by

Avoid locations near doors, air conditioners, fans, etc., where slight breezes can facilitate the entry of bacteria into the chamber.

■ Installation in a sterile room

To get the cultivation more efficiently, install the unit in a sterile room.

■ Use clean containers

The contamination is mainly caused by the containers such as Petri dishes or bottles stored in the chamber. Always keep the containers clean.

TOP SCREEN

The top screen below is displayed when turning on the power switch. The default is; temp. 25.0 °C, Light 0 LS, and 60 %R.H. (MLR-352H only). The date and time are preset at the factory. Refer to page 43 when more accurate setting is needed.

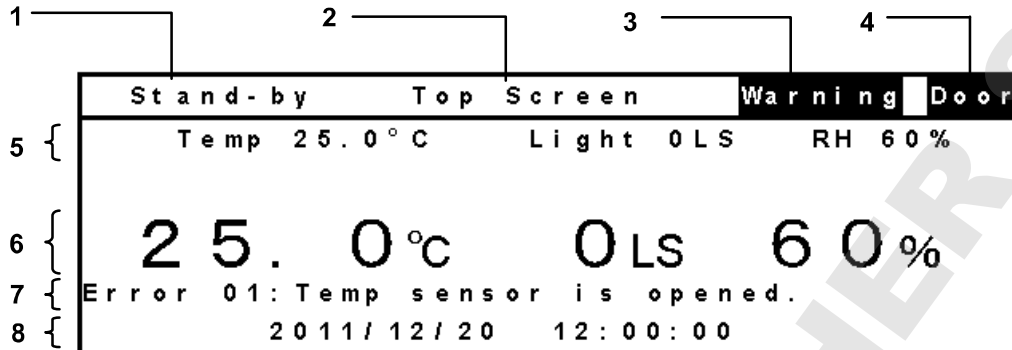

1. Display of running status

The current running status is displayed. At the power-on, "stand-by" is displayed and the operation with standby operation setting is started (page 23). "Running" is displayed alternately in normal characters and reverse video at the time of programmed running. "Defrosting" is displayed alternately in normal characters and reverse video at the time of defrosting.

2. Display of program name

A program name under operation is displayed. "Top Screen" is displayed during standby operation.

3. Status display field

Various status or alarms are displayed.

- "Alarm" is displayed alternately in normal characters and reverse video; When the chamber temperature is out of the set value $\pm 2.5\text{ }^{\circ}\text{C}$ ($\pm 1.0\text{ }^{\circ}\text{C}$ ~ $\pm 10.0\text{ }^{\circ}\text{C}$ changeable) and while alarm delay time.
- "Warning" is displayed alternately in normal characters and reverse video; After alarm delay time while "Alarm" status. When the sensor, the inner fan motor or the condensing fan motor breaks down.
- "Filter" is displayed in reverse video; When the filter is got clogged.

4. Display of door status

"Door" is highlighted when the door is open. After door alarm delay time, "Door" is displayed alternately in normal characters and reverse video.

5. Display of setting

Set values of temperature, light, and relative humidity (MLR-352H only) are displayed. For MLR-352, the location for the relative humidity is blank.

6. Display of current value

Current values of temperature, light, and relative humidity (MLR-352H only) are displayed. For MLR-352, the location for the relative humidity is blank.

7. Message display field

A message is displayed when fault occurs. The message is displayed alternately in normal characters and reverse video. Refer to page 54, 55 for alarm details. Nothing is displayed during normal operation.

TOP SCREEN

8. Display of date and time

The current date (YYYY/MM/DD) and time is displayed.

CAUTION

The relative humidity (RH) is settable between 55 %R.H. and 90 %R.H. (MLR-352H only). MLR-352 has no humidity control. For MLR-352, the display location of relative humidity (setting and current value) is always blank.

FUNCTIONS THROUGH CONTROL PANEL

The following functions are available through control panel:

- **Setting of standby operation:** To set a running condition at the start-up or completion of programmed running (page 23).
- **Setting of key lock:** To set the key lock/unlock (page 24, 25) and the key lock password (page 45).
- **Programming and edit:** To set a new program (page 27), or to edit (page 33), or delete (page 47) a user program.
- **Programmed running:** To start (page 34), skip (page 37) or stop (page 38) a programmed running.
- **Setting of defrost:** To set the automatic defrost (page 39) and to start the manual defrost (page 40).
- **Setting of log cycle and sending to PC:** To set a log cycle of running data (page 43) and to send a running log to PC (page 42).
- **Setting of date and time:** To set the date and time shown on the top screen (page 43)
- **Setting of alarm:** To set the automatic set temperature alarm (page 44), the automatic set humidity alarm (MLR-352H only; page 44), and the high limit (or low limit) temperature alarm (page 26)
- **Default setting:** To set the default for LCD panel and communication (DAQ) speed etc (page 46).

STANDBY OPERATION (MENU/Std-by)

This product automatically operates with standby operation setting (temperature, light step, humidity (MLR-352H only)), when power ON and programmed running is finished. The setting can be changed as necessary.

1. When the top screen displayed, press the menu button (MENU) to show the menu window. Select "Std-by". and press the enter key (ENTER).

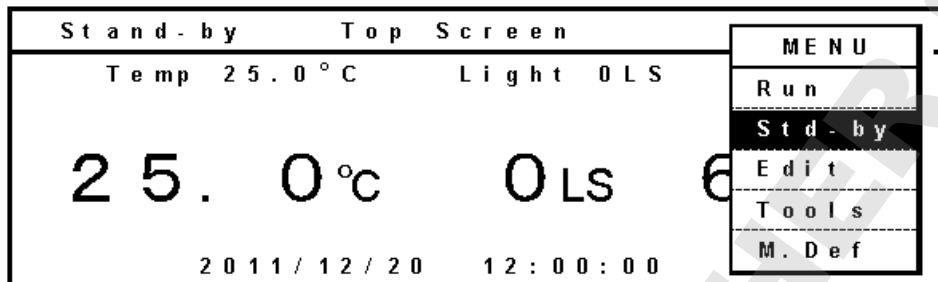

2. Stand-by Setting screen is displayed. Set each parameter. Press the menu button (MENU) after complete parameter setting. The menu window is shown. Select "OK" and press the enter key (ENTER). The parameter is memorized.

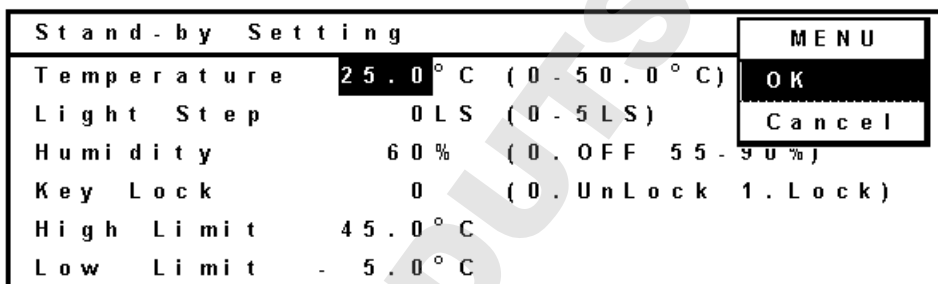

The settable range of each parameter:

- Temperature : 0 °C~50 °C ■ Light step : 0 LS~5 LS
- Humidity : OFF or 55 %R.H.~90 %R.H. (MLR-352H only)

Note:

- The menu screen will automatically turns off when there is no key action for 1 minute.
- Set the humidity to 0 (OFF) when the humidity control is not necessary with MLR-352H.

SETTING OF KEY LOCK (MENU/Std-by)

Setting of Key Lock(Key Lock)

1. When setting of key lock, change the value of the key lock line from “0” to “1” in the stand-by setting screen(Stand-by Setting).

Stand-by Setting	Key Lock
Temperature 25.0 °C (0 - 50.0 °C)	
Light Step 0LS (0 - 5LS)	
Humidity 60% (0. OFF 55 - 90%)	
Key Lock 1 (0. UnLock 1. Lock)	
High Limit 45.0 °C	
Low Limit - 5.0 °C	

2. Press the menu button (MENU) and select “OK”, and press the enter key (ENTER). The key is locked. In this status, any other setting except key lock is not available. The other settings except key lock cannot be changed.

Stand-by Setting	MENU
Temperature 25.0 °C (0 - 50.0 °C)	OK
Light Step 0LS (0 - 5LS)	Cancel
Humidity 60% (0. OFF 55 - 90%)	
Key Lock 1 (0. UnLock 1. Lock)	
High Limit 45.0 °C	
Low Limit - 5.0 °C	

Setting of Key Unlock(Key Unlock)

1. When setting of key unlock, change the value of the key lock line from “1” to “0” in the stand-by setting screen (Stand-by Setting) and press the enter key (ENTER).

Stand-by Setting	Key Lock
Temperature 25.0 °C (0 - 50.0 °C)	
Light Step 0LS (0 - 5LS)	
Humidity 60% (0. OFF 55 - 90%)	
Key Lock 0 (0. UnLock 1. Lock)	
High Limit 45.0 °C	
Low Limit - 5.0 °C	

2. Input password of 4 digits to the password field (Password) where the cursor is moved to, and press the enter key (ENTER). “Key Lock” disappears in the stand-by setting screen (Stand-by Setting).

Stand-by Setting	Key Lock
Temperature 25.0 °C (0 - 50.0 °C)	
Light Step 0LS (0 - 5LS)	
Humidity 60% (0. OFF 55 - 90%)	
Key Lock 0 Password xxxx	
High Limit 45.0 °C	
Low Limit - 5.0 °C	

3. Press the menu button (MENU) to show the menu window, and select “OK” and press the enter key (ENTER). The key is unlocked.

Caution:

The buzzer rings for a long time when a wrong password is input. Input a correct password. The password for key unlock must be shared and administered by all users on this product. The default User Password when shipped from the factory is “0000”. Refer to page 45 for changing the password.

HIGH LIMIT/LOW LIMIT ALARM (MENU/Std-by)

A high limit temperature alarm and low limit temperature alarm are provided with this product. The alarm temperature can be changed as follows:

1. With the top screen displayed, press the menu button (MENU) to show the menu window. Select "Std-by", and press the enter key (ENTER).

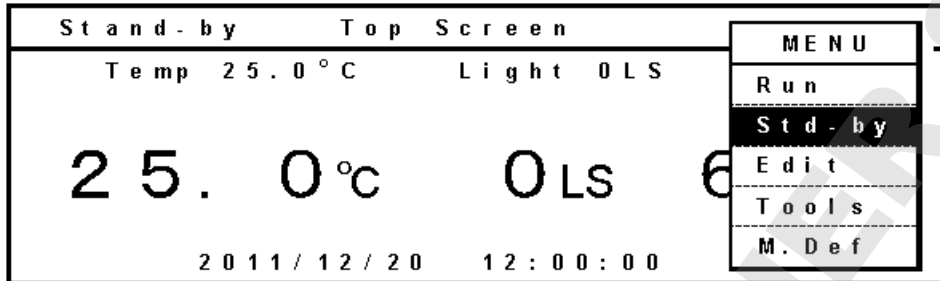

2. Stand-by Setting screen is displayed.

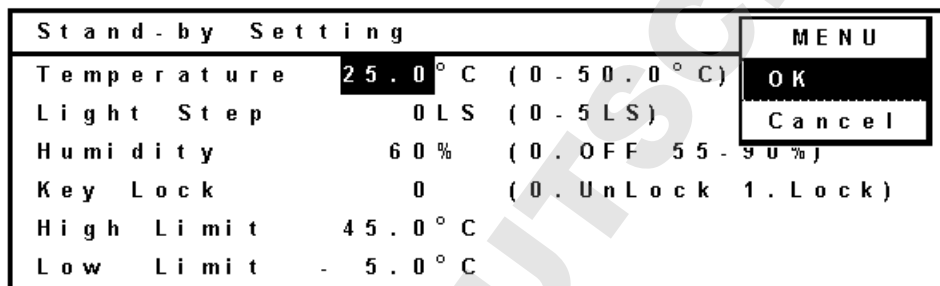

3. Set the desired high limit temperature alarm by turning the high limit temperature alarm volume (HIGH LIMIT) at the center of the control panel by using a small screw driver. The settable alarm temperature is between 15.0 °C and 55.0 °C.

Note:

Set the high limit temperature alarm (High Limit) 5 °C higher than the maximum temperature in a program.

4. Set the desired low limit temperature alarm by turning the low limit temperature alarm volume (LOW LIMIT) at the center of the control panel by using a small screw driver. The settable alarm temperature is between -10.0 °C and 25.0 °C.

Note:

Set the low limit temperature alarm (Low Limit) 5 °C lower than the minimum temperature in a program.

5. Press the menu button (MENU) at the completion of setting. The menu window is shown. Select "OK" and press the enter key (ENTER). The alarm temperature is memorized.

Refer to alarms and safety functions of page 54, 55 for details.

Note:

These high limit temperature alarm (High Limit) and low limit temperature alarm (Low Limit) are effective during a programmed running as well.

PROGRAMMING (MENU/Edit)

This product has two modes, which are clock mode and timer mode. The clock mode is used to set a change time to the next step in a day time (24 hours). The timer mode is used to set a time for each step directly and the remained time is displayed.

The selection of either mode is available on the running mode selection screen at the starting of the program.

Example 1:

Following shows the procedure to create a new program "Oze" of which cycle is 31 with clock mode. The details of "Oze" is as follows:

STARTING TIME	6:00	9:00	11:00	13:00	14:00	15:00	17:00	19:00	22:00	23:00	6:00
Temperature (°C)		12	15	20	25	20	18	15	15	12	10
Humidity (%R.H.)		80	80	60	60	60	70	75	80	80	80
Light step (LS)		1	2	3	5	4	3	1	0	0	0

Humidity setting is for MLR-352H only.

1. With the top screen displayed, press the menu button (MENU) to show the menu window.

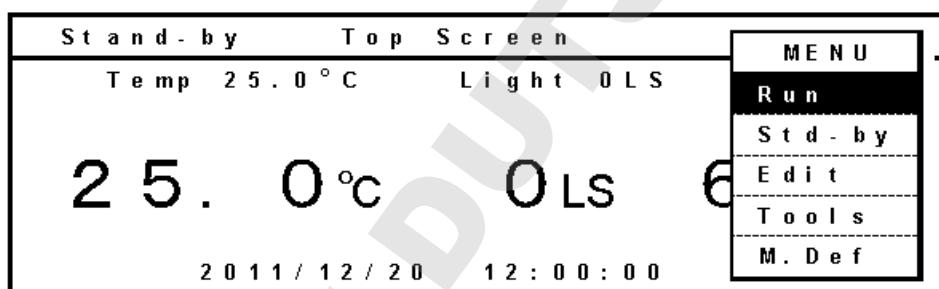

2. Select "Edit", and push the enter key (ENTER).

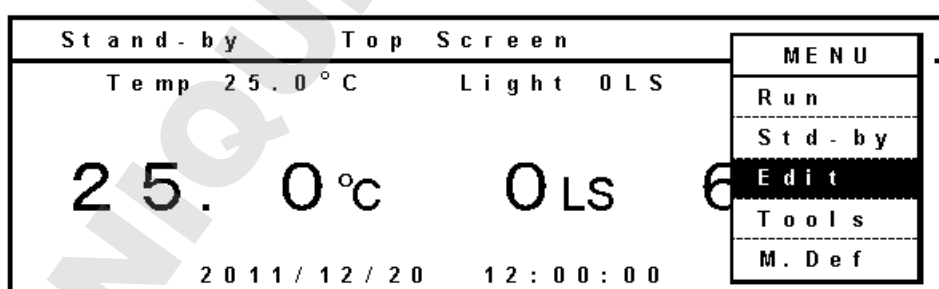

3. The Program Name Stored screen is opened. Press the menu button (MENU) and select "New", and press the enter key (ENTER). The program names are displayed when some programs have already been saved.

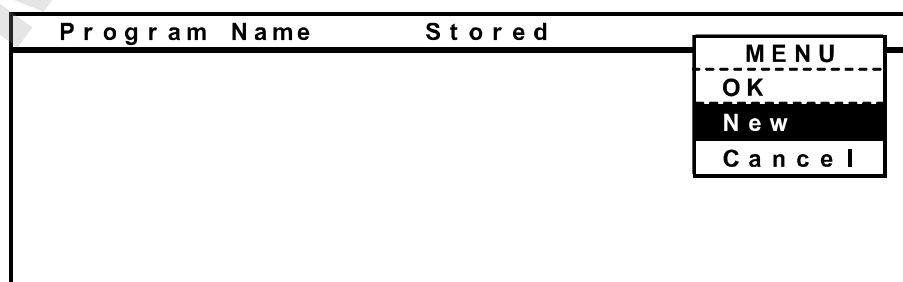

PROGRAMMING (MENU/Edit)

4. A model program is displayed. The screen is scrolled to the next page by using the rightward shift key.

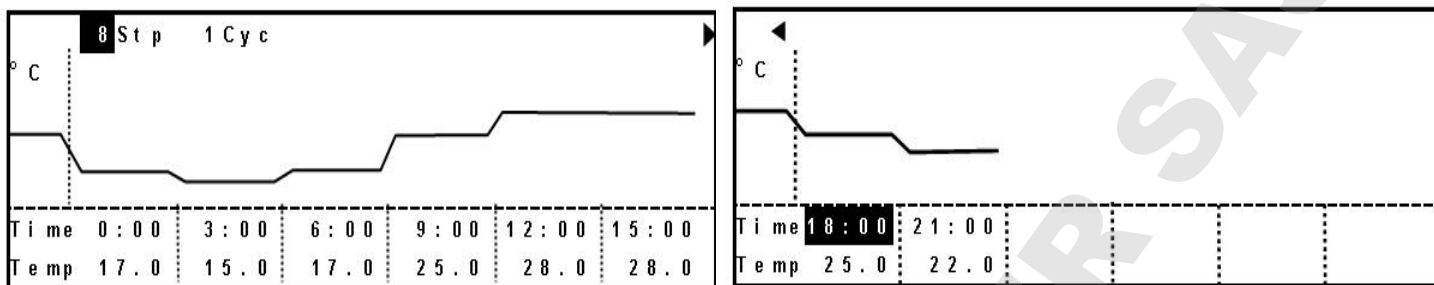

The step number (Stp :step) and cycle number (Cyc :repeat number) can be changed on the top left corner (8 Stp 1 Cyc) of the screen. Highlight the numerical value by shift key, and input 10 Stp 31 Cyc by character input key. The step number and cycle number are changed.

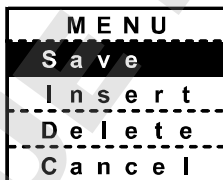
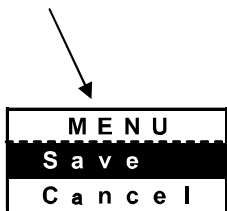
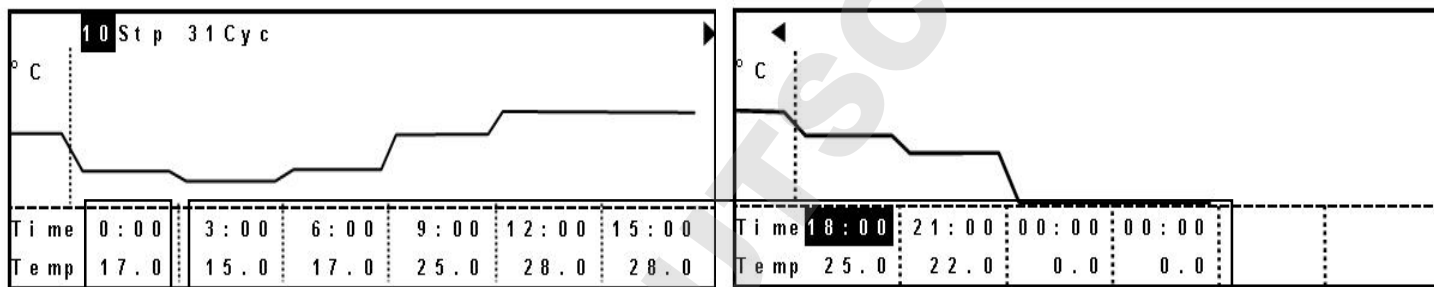

The step number (Stp) can also be changed by "Insert" or "Delete" on the menu window. Press the menu button (MENU), to open the menu window. The menu window for a first section has no "Insert" or "Delete". Therefore, neither insert nor delete is effective for the first section. The maximum step number is 12. The cycle number is 1 when the step number is 1. The settable cycle number is up to 98. The cycle number 99 means limitless repeat.

5. Highlight the numerical value of each time section (Time) by shift key, and input as below by character input key.

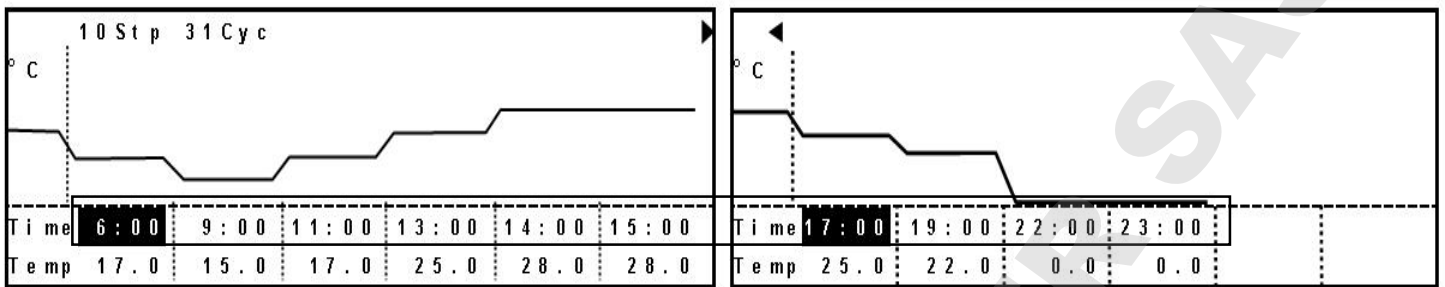

Note:

The time setting value differs between clock mode and timer mode. In the case of clock mode, the setting range is between 00:00 and 23:59. Set the value from the earlier one.

Note:

Since the setting range for clock mode is from 00:00 to 23:59, programs set for over 24:00 will not run (e.g. 23:00~25:00). In this case, the previous program will be continuously repeated.

6. Shift a cursor downward by the downward shift key. Set the temperature as follows. The setting range is between 0.0 °C and 50.0 °C.

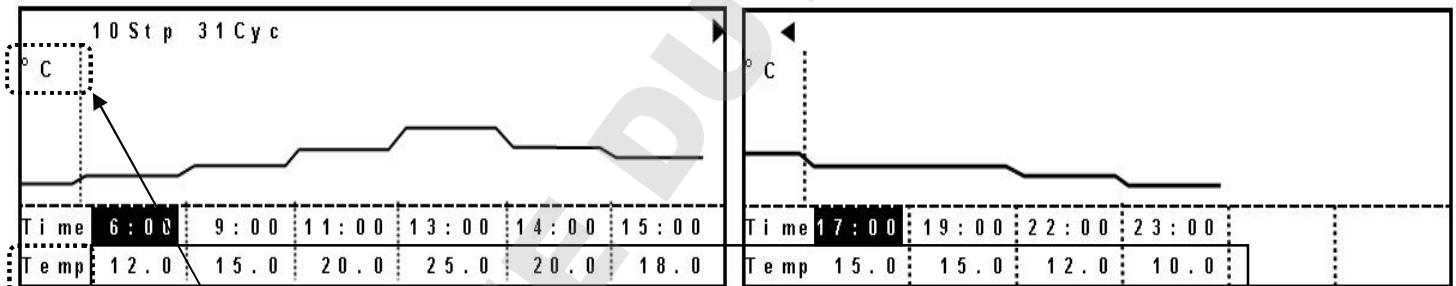

During temperature setting, "°C" is displayed at upper left.

⚠ CAUTION

The settable temperature is between 0.0 °C and 50.0 °C, but the temperature control range for MLR-352H is between 5 °C and 50.0 °C. The temperature control range is between 10 °C and 50.0 °C when the light is ON (for MLR-352 and MLR-352H).

PROGRAMMING (MENU/Edit)

7. Shifting a cursor downward by downward shift key moves to the next edit "Light" (light step).

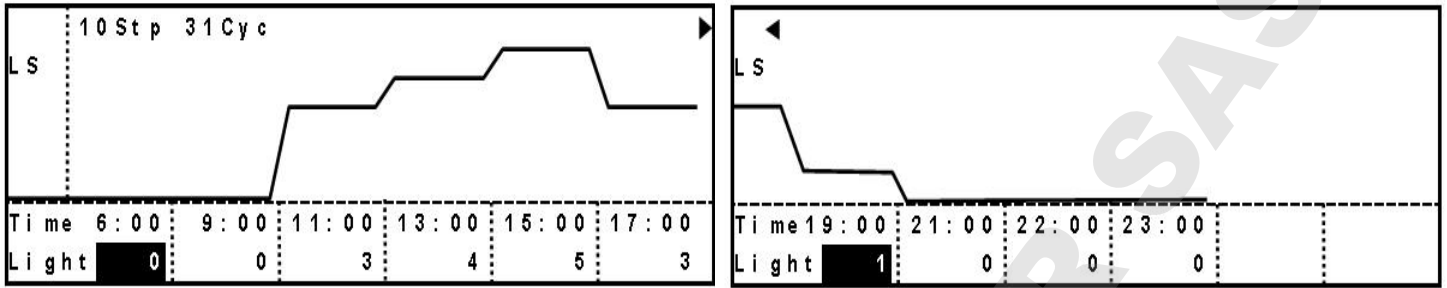

Set a light step as below. The setting range is between 0 and 5.

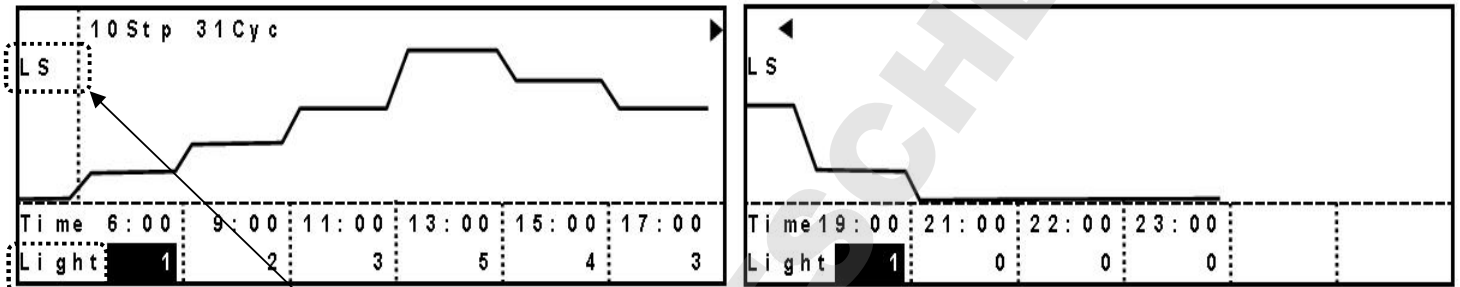

During light step setting, "LS" is displayed at upper left.

8. For MLR-352H, shifting a cursor downward further by the downward shift key moves to the next edit "RH" (relative humidity). For MLR-352, shifting moves to the edit "Temp".

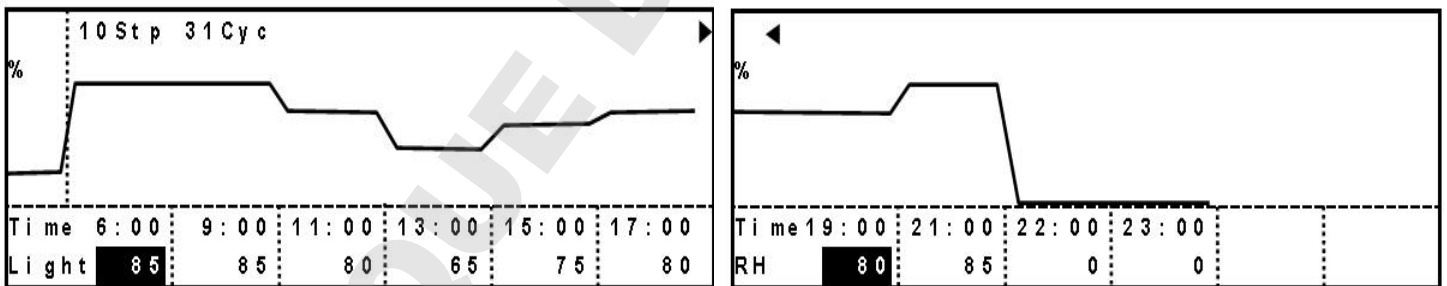

Set a relative humidity as below. The setting range is between 55 %R.H. and 90 %R.H..

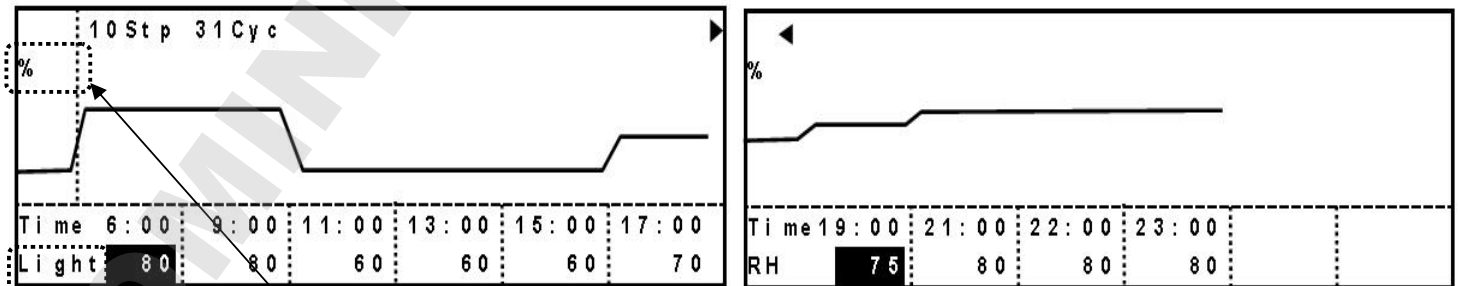

During relative humidity setting, "%" is displayed at upper left.

Note:

The edit item is shifted with the following order by pressing the downward shift key:

MLR-352: Temperature (Temp), light step (LS), temperature (Temp)

MLR-352H: Temperature (Temp), light step (LS), relative humidity (RH), temperature (Temp)

9. At the completion of all input, press the menu button (MENU) to show the menu window. Select "Save", and press the enter key (ENTER). Save Program screen is opened.

10. Input a program name (Oze), and press the menu button (MENU) to show the menu window. Select "Save As", and press the enter key (ENTER). The program is entered. The maximum numbers of character for program name is 16. Refer to edit function of characters described below. Up to 10 programs are created and saved.

Edit function of characters

Shift key

- **Upward shift key** : Space insertion
- **Downward shift key** : backspace
- **Leftward shift key** : Move a cursor left
- **Rightward shift key** : Move a cursor right

Character input key

- | | | |
|----------------------------------|------------------------------|----------------------------------|
| 1 key : space,-,"#, @,1 | 2 key : A,B,C,a,b,c,2 | 3 key : D,E,F,d,e,f,3 |
| 4 key : G,H,I,g,h,I,4 | 5 key : J,K,L,j,k,l,5 | 6 key : M,N,O,m,n,o,6 |
| 7 key : P,Q,R,S,p,q,r,s,7 | 8 key : T,U,V,t,u,v,8 | 9 key : W,X,Y,Z,w,x,y,z,9 |
| | | 0 key : &,/, (,),.,0 |

PROGRAMMING (MENU/Edit)

Example 2:

To create the following program with timer mode and name "NIKKO". The cycle is 99, that is limitless repeat.

STEP TIME	48	36
Temperature (°C)	20	30
Humidity (%R.H.)	80	60
Light step (LS)	3	5

1. Display a model program as shown on page 27.

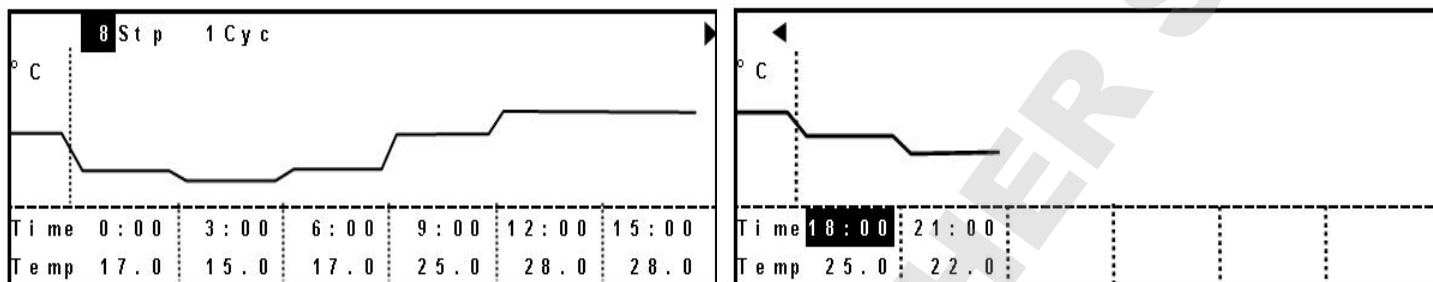

Change the step number and cycle number to 2Stp and 99Cyc by character input key. Only one page is displayed and 99 is changed into ∞. Display of ∞ changes to 99 when placing a cursor.

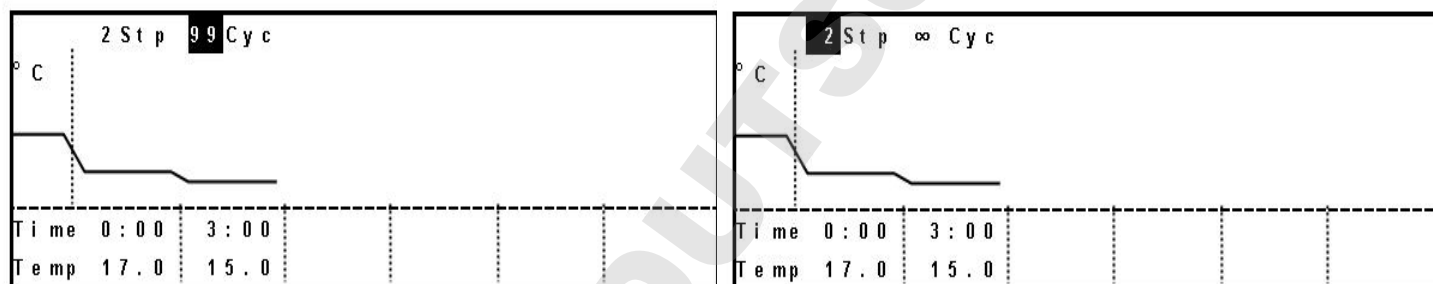

2. Set a time, temperature and relative humidity (MLR-352H only) as same as Example.1.

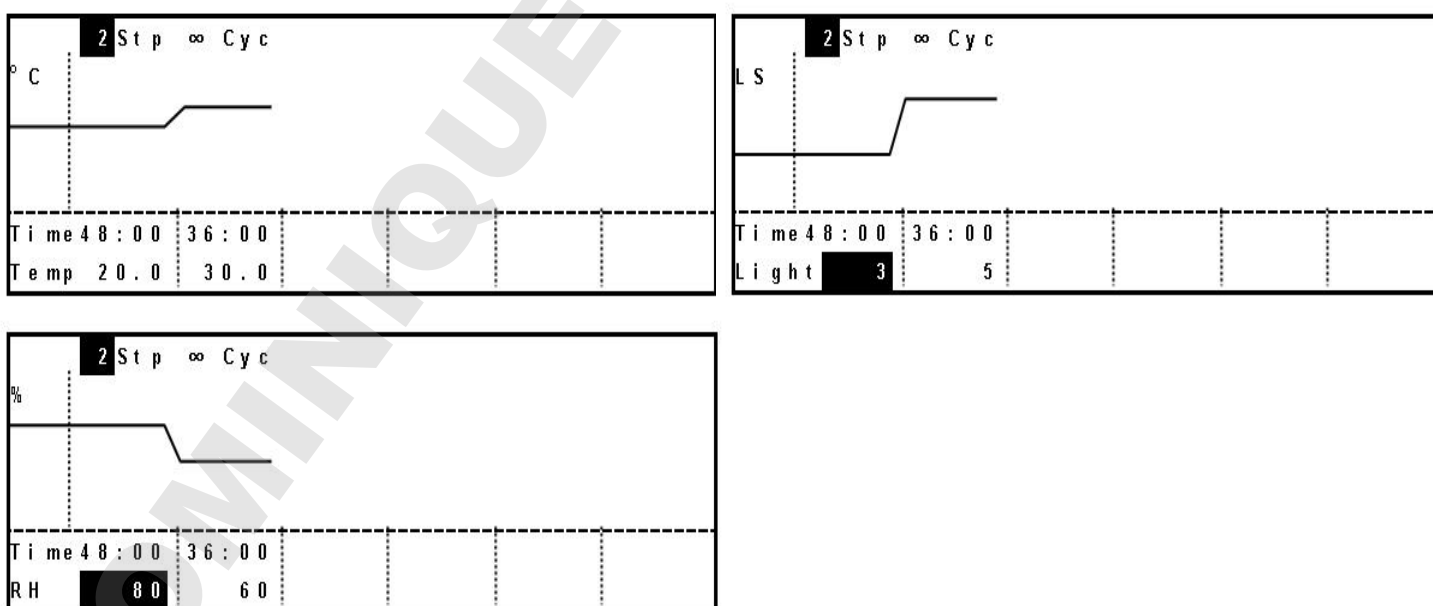

Note: The time setting value differs between clock mode and timer mode. In the case of timer mode, setting range is between 00:01 and 99:59. The setting of "99:99" means limitless repeat.

3. Input a program name (NIKKO), press the menu button (MENU) to show the menu window. Select "Save As", and press the enter key (ENTER) to save the program as same as Example.1.

EDIT OF SAVED PROGRAM (MENU/Edit)

1. With the top screen displayed, press the menu button (MENU) to show the menu window. Select "Edit", and press the enter key (ENTER).

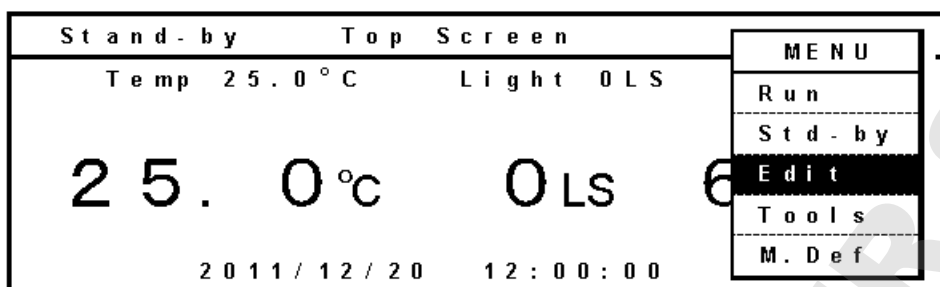

2. The saved programs are shown. Select a program (for example : Oze) to be edited and press the menu button (MENU). The menu window is opened. Select "OK", and press the enter key (ENTER).



3. The program "Oze" is displayed. After changing the setting, press the menu button (MENU) to show the menu window. Select "Save", and press the enter key (ENTER).

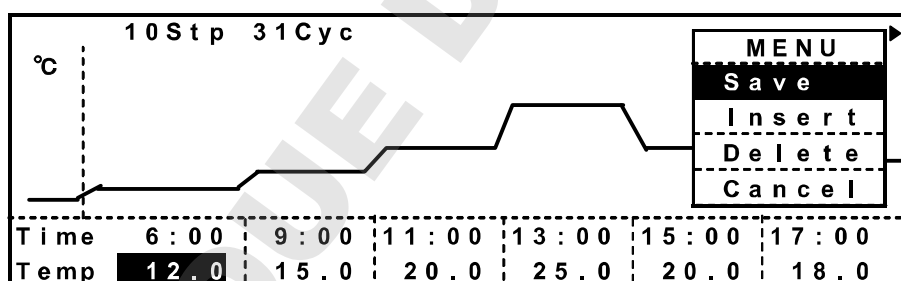

4. Save Program screen is opened. Input program name, and press the menu button (MENU) to show the menu window. Select "Save" when saving by overwriting, or select "SaveAs" when saving with another program name. Press the enter key (ENTER). The edited program is entered. Do not select "SaveAs" with same program name as another program.

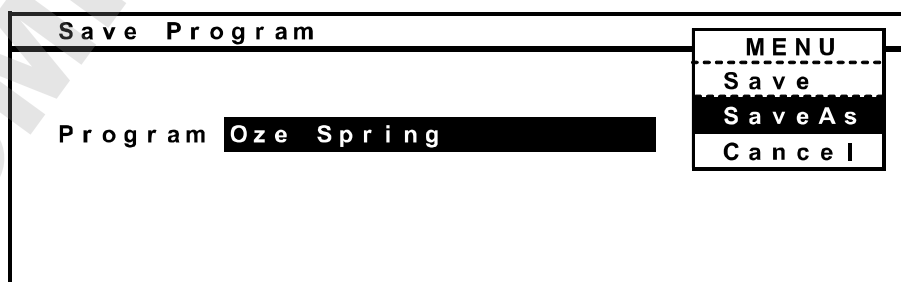

START OF PROGRAM (MENU/Run)

1. With the top screen displayed, press the menu button (MENU) to show the menu window. Select "Run", and press the enter key (ENTER).

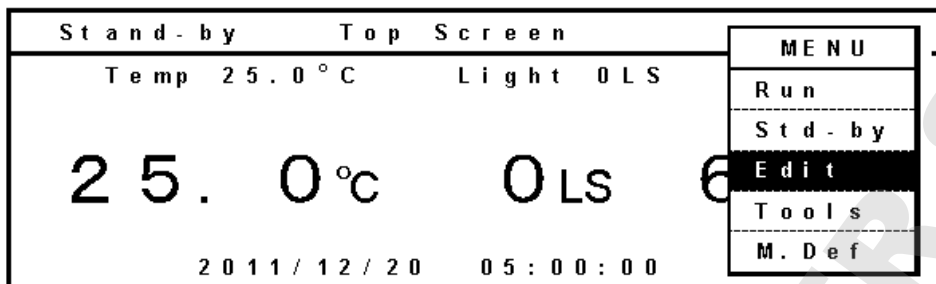

2. Program Name Stored screen is opened. Select "Oze" and press the menu button (MENU) when starting "Oze" program. Select "OK" on the menu window, and press the enter key (ENTER).



3. Start Options screen is opened. On this screen, setting of Timer (selection of Clock mode or Timer mode), Join (Joining some programs), and start date is available. As the "Oze" is for clock mode, select 1 (Clock) for Timer. For join, select 2 (No : not join) since the Oze does not have joined program. Input the start date (11/12/20) and time (06:00:00), and press the menu button (MENU) to show the menu window. Select "OK", and press the enter key (ENTER).

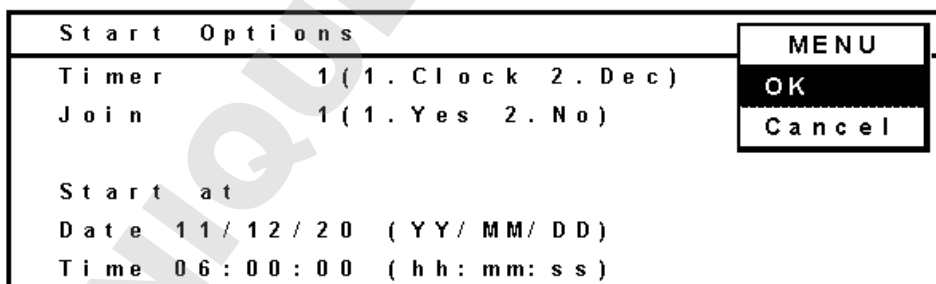

■ Timer (selection of Clock mode or Timer mode)

1. Clock (Clock mode): Displays start time of each steps.
2. Dec (Timer mode): Displays the remaining time up to a next step.

■ Join (Joining some programs)

Join 1.Yes: The joined programs are operated when a selected program is set as a join program. Refer to page 36 for details.

■ Start at (desired start date)

First, date and time when the window is opened is displayed. Input the desired start date and time.

4. The selected program is displayed. Check the program and press the menu button (MENU) to show the menu window. Select "Start", and press the enter key (ENTER).

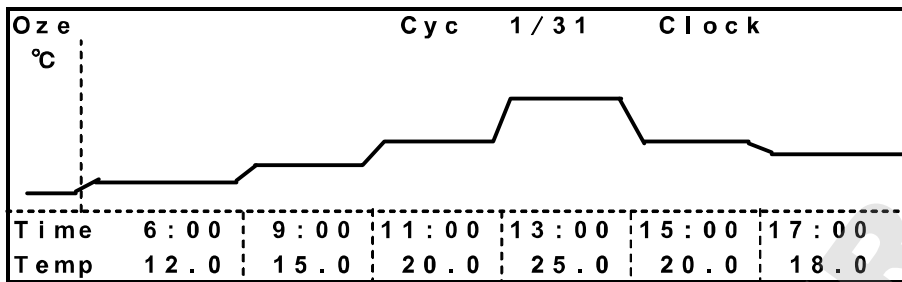

5. The program is started at desired date and time. During the programmed running, the graphic screen as below is displayed. To change the graphic screen to the top screen, press the menu button (MENU) to show the menu window. Select "Top" and press the enter key (ENTER). To change to the graphic screen, press the menu button (MENU) to show the menu window. Select "Graph" and press the enter key (ENTER).

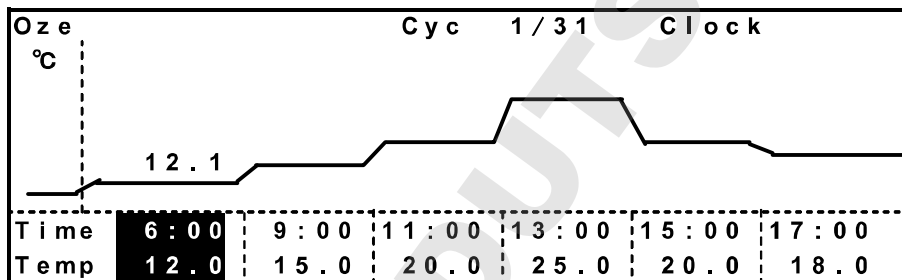

Running	Oze	MENU	
Temp 12.0 °C	Light 1LS	Graph	
12.0 °C	1LS	Std-by	
		Edit	
		Tools	
		M. Def	
2011/12/20 08:00:00			

JOIN FUNCTION

The unit has join function to run several programs continuously. The maximum program to be joined is 9. The setting of join function is as follows:

1. When joining three programs Spring, Summer and Autumn, input the same character string, # , and one digit figure (joined order) before the each program name. Each program operates as a special program for join function. Any character or figure is permitted for a string on the top. The program cannot be joined when the character string is not same.

Note: The characters after one digit figure have no effect on the join function.

Ex.1: When joining the program Spring, Summer and Autumn with this order and top character string is "Oze" the input for the join function is as follows:

Oze#1 Spring Oze#2 Summer Oze#3 Autumn

Ex.2: When joining in the order of Autumn, Spring and Summer and input "NIKKO" as the same character string, the input for the join function is as follows:

NIKKO#2 Spring NIKKO#3 Summer NIKKO#1 Autumn

2. When running the joined program in Ex.1, select the program Oze#1 Spring on the Program Name Stored screen in MENU/Run (Refer to page 34).

Note: The program Oze#2 Summer is selected, the program Oze#2 Summer and Oze#3 Autumn are performed. Oze#1 Spring is not joined.

3. Select 1.Yes for the join function on the Start Options screen. Press the menu button (MENU) to show the menu window. Select "OK" and press the enter key (ENTER).

Note: The joined function is not effective if select 2. No on the Start Options screen.

4. Press the menu button (MENU) to show the menu window. Select "Start" and press the enter key (ENTER). The joined program is started.

5. Running result

Run in the order of Oze#1 → Oze#2 → Oze#3. During the running of joined program, "Join" is displayed at the upper right on the screen.

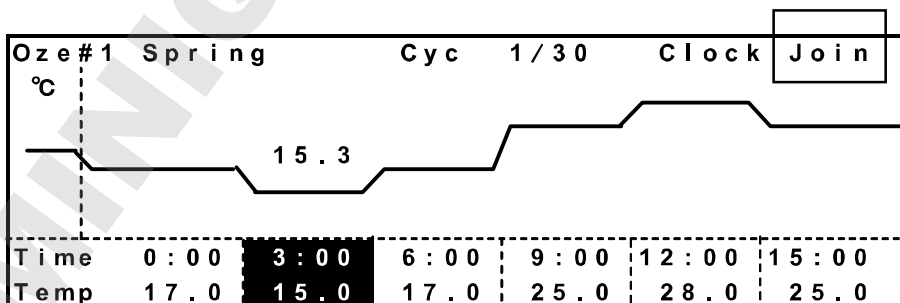

SKIP OF STEP (MENU/Skip)

During the programmed running, the skip function is effective to skip a current step in the program.

1. Press the menu button (MENU) to show the menu window and select "Graph" when the top screen is displayed. Then press the enter key (ENTER).
2. Press the menu button (MENU) under program running and the menu window is opened. Select "Skip", and press the enter key (ENTER).

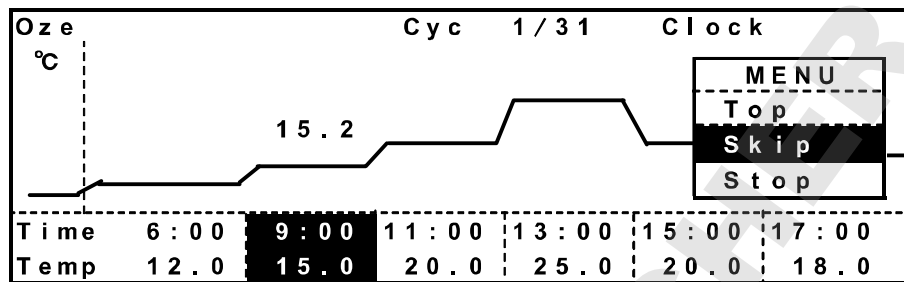

3. The Confirmation screen is displayed. Press the menu button (MENU). Selecting "Next" causes the skip to the next step. Selecting "Back" causes the skip to the previous step. After selecting "Next" or "Back", press the enter key (ENTER).

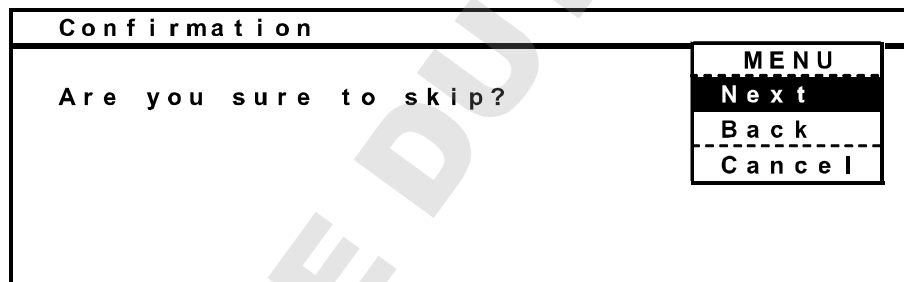

Note: It cannot go back prior to the current time by the skip function when the program is running in clock mode.

STOP OF PROGRAM (MENU/Stop)

During the programmed running, it is possible to stop the running at any step.

1. Press the menu button (MENU) to show the menu window and select "Graph" when the top screen is displayed. Then press the enter key (ENTER).
2. Press the menu button (MENU) under program running and the menu window is opened. Select "Stop", and press the enter key (ENTER).

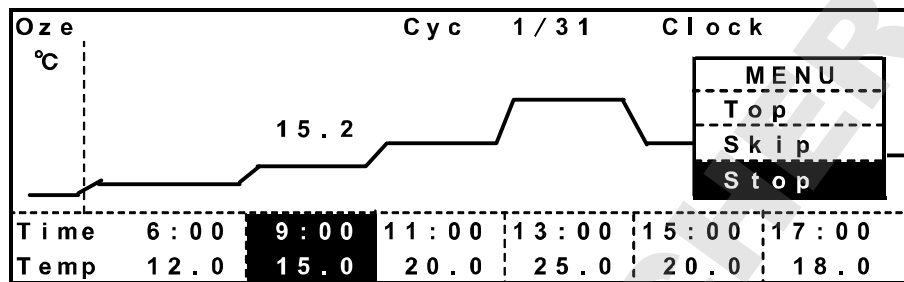

3. The Confirmation screen is displayed. Press the menu button (MENU). Selecting "OK" and press the enter key (ENTER) to stop the program.



4. After stopping the program, the unit continues to run with the setting of standby operation.

AUTOMATIC DEFROST (MENU/Tools/Date Time)

This product has a main evaporator to control the chamber temperature low, and a sub evaporator (MLR-352H only) to control the chamber humidity low. Automatic defrost function defrosts the frost on the main and sub evaporators automatically at 3:00 a.m. and 3:00 p.m. in a day. Following 3 defrost patterns are selectable. The default setting is pattern 2 (recommendation). In case the setting temperature is lower than 10 °C, select pattern 2 or 3.

Warning: During defrosting, the chamber humidity is unstable (MLR-352H only). For MLR-352, the automatic defrost operates when the setting is either pattern 2 or 3 only.

MLR-352

	AM 3:00	PM 3:00
1	Automatic defrost is canceled	
2	Main evaporator	----
3	Main evaporator	Main evaporator

MLR-352H

	AM 3:00	PM 3:00
1	Sub evaporator	Sub evaporator
2	Main evaporator + Sub evaporator	Sub evaporator
3	Main evaporator + Sub evaporator	Main evaporator + Sub evaporator

1. Press the menu button (MENU) to show the menu window and select "Tools" when the top screen is displayed. Then press the enter key (ENTER).

2. Select "Date Time" on the Select Tools screen, and press the menu button (MENU) to show the menu window. Select "OK" and press the enter key (ENTER).

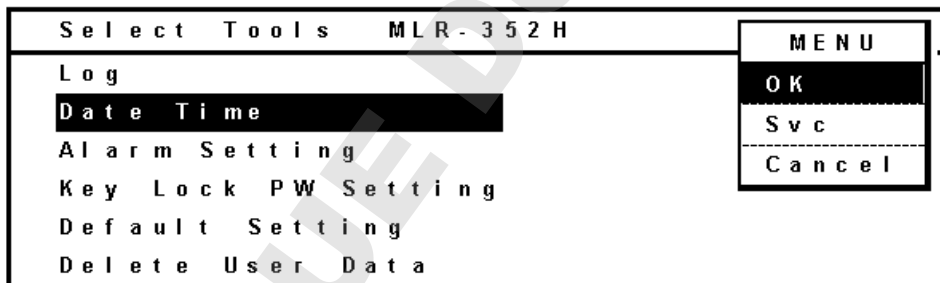

3. The Date Time screen is displayed. Input the defrost timer pattern (1, 2, or 3).

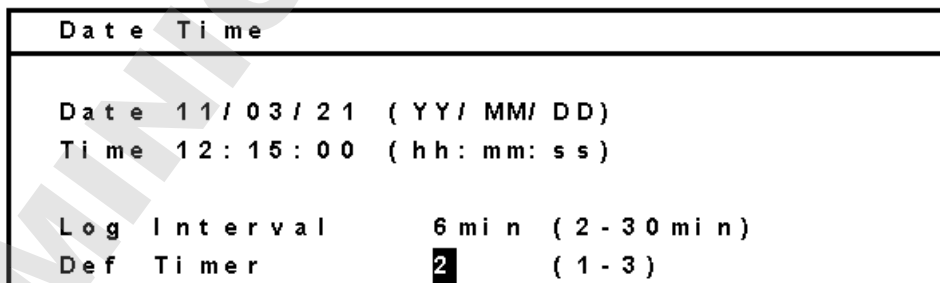

⚠ CAUTION

A sub evaporator of MLR-352H tends to get much frost than a main evaporator. Therefore, the automatic defrost is applied to the sub evaporator twice a day.

The manual defrost for the main evaporator is needed when the automatic defrost is not sufficient to remove the frost. For the manual defrost, refer to next page.

MANUAL DEFROST (MENU/M.def)

The manual defrost function is for defrosting the frost on the main evaporator at any time when you need. The manual defrost can be started during programmed running, standby operation, or automatic defrosting. The manual defrost function is applied to the sub evaporator too. When a lot of frost on the main evaporator is found through the frost check window, start the manual defrost.

1. Press the menu button (MENU) to show the menu window. Select "M.Def" and press the enter key (ENTER).

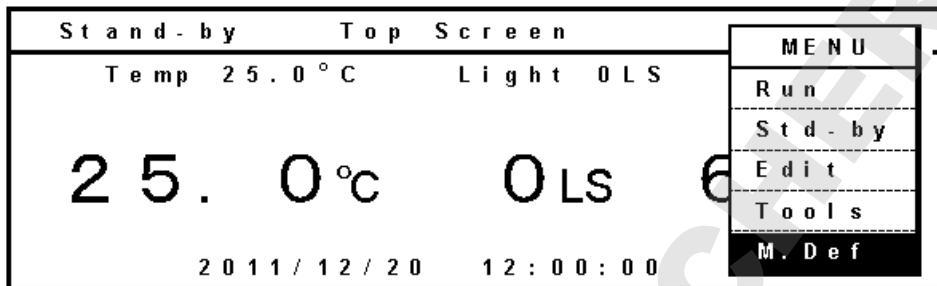

2. The Confirmation screen is displayed. Press the menu button (MENU) to show the menu window. Select "OK", and press the enter key (ENTER).

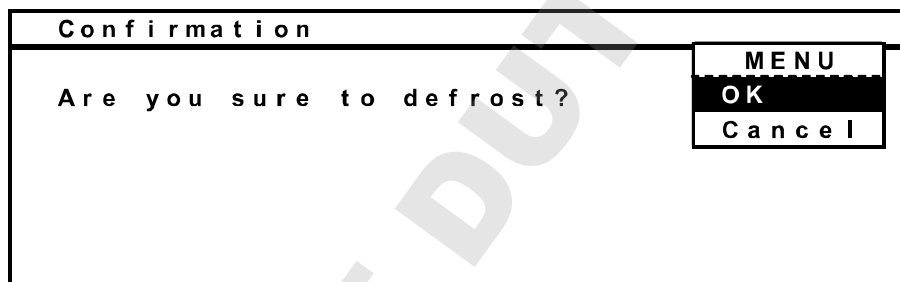

3. The manual defrost is started. During defrosting, "Defrosting" is displayed at the upper left on the top screen.

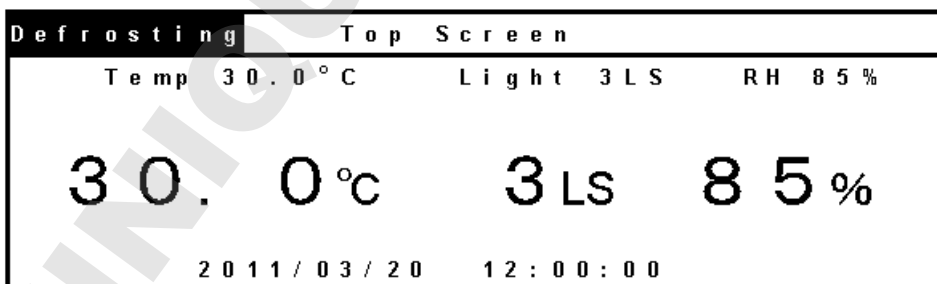

4. The manual defrost is finished automatically. The defrosting time depends on the amount of frost on the evaporator.

VARIOUS SETTING (MENU/Tools)

The log can be displayed and various setting can be changed by using "Tools" menu.

1. Press the menu button (MENU) with the top screen displayed to show the menu window. Select "Tools, and press the enter key (ENTER).

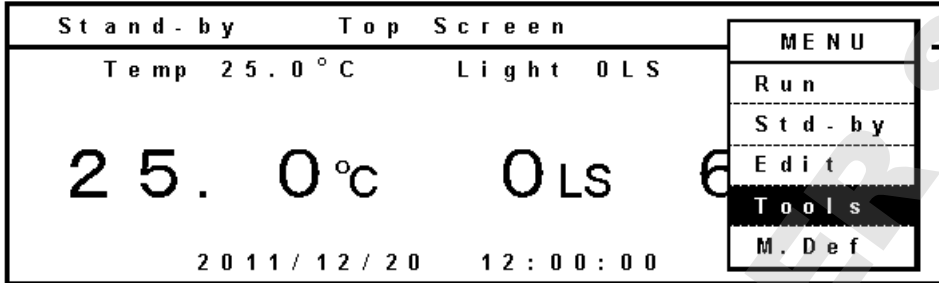

2. The Select Tools screen is as follows.

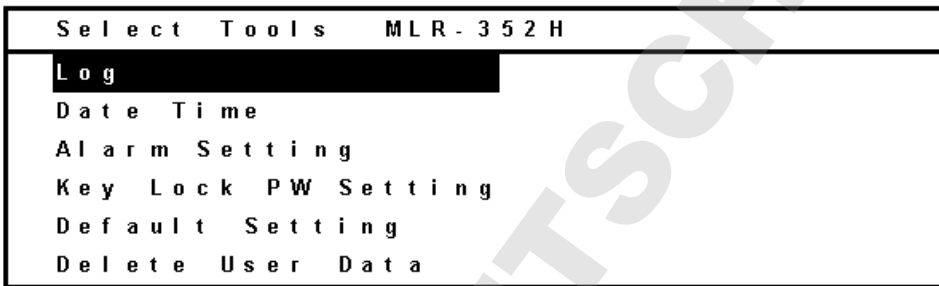

Display of log (Tools/Log)

1. Select "Log" in the Select Tools screen. Press the menu button (MENU) to show the menu window. Select "OK", and press the enter key (ENTER).

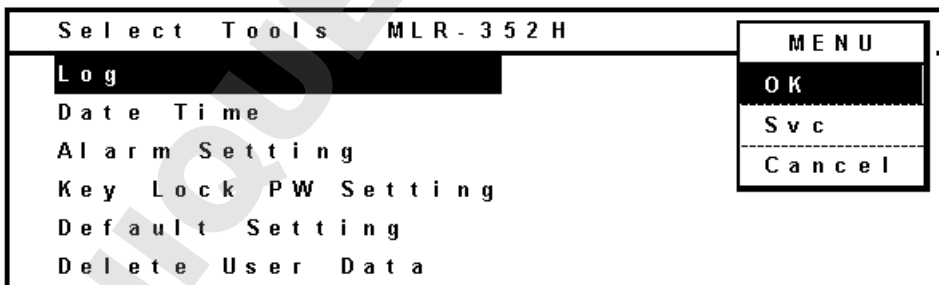

2. The log is presented with dot. By pressing the upward shift key or downward shift key, the log to be displayed is changed; temperature, light step, and humidity (MLR-352H only). The displayed date is scrolled by pressing the leftward or rightward shift key. (leftward shift key; older date, rightward shift key; newer date.)

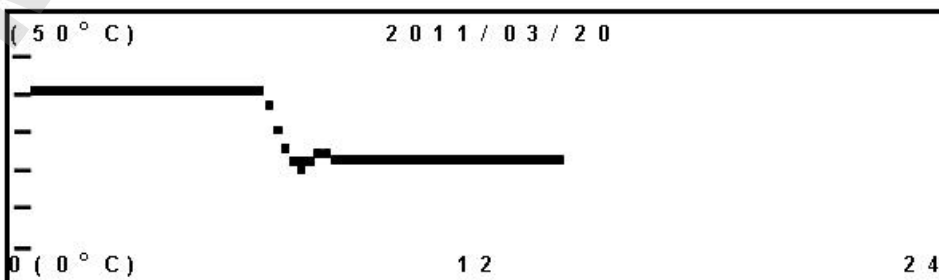

VARIOUS SETTING (MENU/Tools)

Data transmission

The procedure to transmit the log data to a PC is as follows.

1. Press the menu button (MENU) to show the menu window. Select "PC 1D", and press the enter key (ENTER) when the log for one day is necessary. Select "PC All", and press the enter key (ENTER) when all data recorded is necessary.

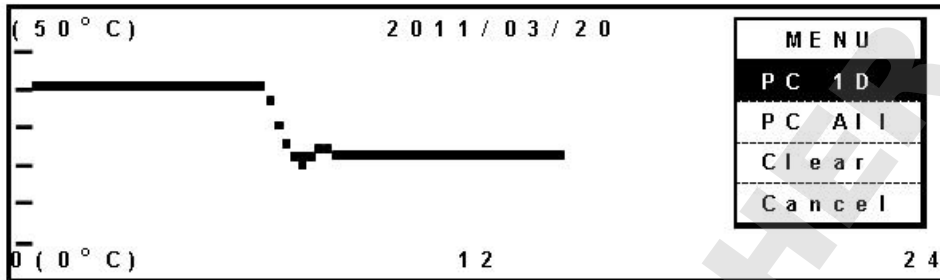

2. The Progress screen is displayed. Specify a transfer, capture of text and retention file by operation of hyper terminal on PC. Apply "txt" or "csv" as an extension of retention file. Press the menu button (MENU) to show the menu window. Select "Start", and press the enter key (ENTER). The transmission is started. "Finished" display means the end of transmission.

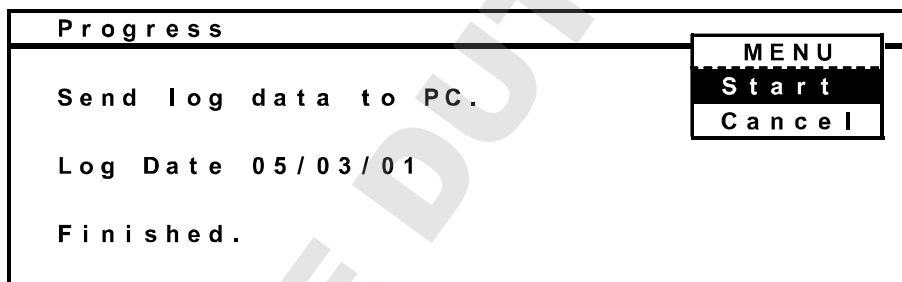

Setting in PC side for transmission of log data (For Windows 2000, and Windows XP)

1. From start button, start the hyper terminal (start button → program → accessory → communication -hyper terminal).
(when not registered in the start menu, C:\Program Files\Windows NT\hypertm.exe)
2. Through the hyper terminal display, set a new connection, a name (for example: Matsushita), a connection, a connecting method, COM1, property of COM1, and a port.
bit/sec; 9600, data bit; 8, parity; no, stop bit; 1, flow control; Xon/Xoff.
(Communicating condition of MLR-352 side is set as above automatically when the Progress screen is displayed.)

Note:

For the data transmission, an optional communication terminal MTR-480 and a 9 pin cable of Dsub cross type for RS232C are needed.

Setting of date, time, log (Tools/Date Time)

1. Select "Date Time" in the Select Tools screen. Press the menu button (MENU) to show the menu window. Select "OK", and press the enter key (ENTER).

Select Tools MLR-352H	MENU
Log	OK
Date Time	Svc
Alarm Setting	Cancel
Key Lock PW Setting	
Default Setting	
Delete User Data	

2. The Date Time screen is displayed. Set date, time, or log cycle.

Date Time	
Date	11 / 10 / 21 (YY / MM / DD)
Time	14 : 15 : 00 (hh : mm : ss)
Log Interval	10 min (2 - 30 min)
Def Timer	2 (1 - 3)

■ Date input (Ex: October 21, 2011)

Input 111021 in the date cell.

■ Time input (Ex: 14:15)

Input 141500 in the time cell.

■ Log cycle input (Ex: 10 minutes)

Input 10 in log Interval cell. The acceptable range is between 2 minutes and 30 minutes. The default is 6 minutes.

■ Relation between the log interval and spans that can be memorized

1: Log interval 2 min About 5 days

2: Log interval 6 min About 14 days

3: Log interval 30 min About 70 days

After passing the memory limit, the older data is deleted and newer data is memorized.

VARIOUS SETTING (MENU/Tools)

Alarm setting (Tools/Alarm Setting)

1. Select "Alarm Setting" in the Select Tools screen. Press the menu button (MENU) to show the menu window. Select "OK", and press the enter key (ENTER).

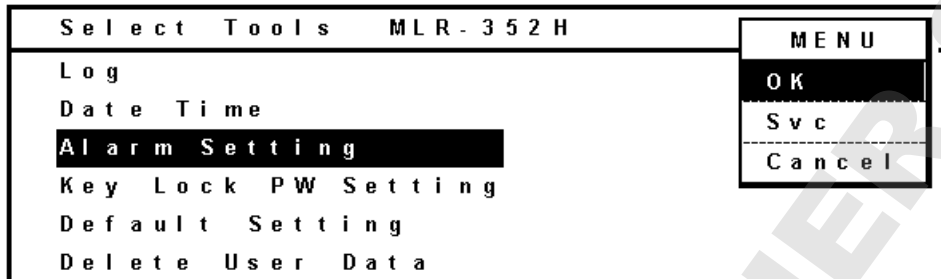

2. The Alarm Setting screen is displayed. On this screen, the automatic set temperature alarm (Temp Alarm), the automatic set humidity alarm (RH Alarm) (For MLR-352, it is not possible to set), the automatic set temperature alarm delay time (Alarm Delay), alarm resume time (Ring Back), the door alarm delay time (Door Alarm Delay) and door alarm resume time (Door Ring Back) can be set.

<Alarm Delay>

This is the time from when the chamber temperature deviates from the setting range of automatic set temperature alarm and till the buzzer goes off.

<Ring Back>

The alarm buzzer is silenced by pressing the alarm buzzer stop key (BUZZER) during alarm condition. The buzzer will be activated again after certain suspension if the alarm condition continues. The suspension time (ring back) can be set. The ring back is applicable to the automatic set temperature alarm and automatic set humidity alarm (MLR-352H only).

<Door Alarm Delay>

The time from when the door is opened till the buzzer goes off.

<Door Ring Back>

Door alarm resumes after the specific period.

Alarm Setting	
Temp Alarm	± 2.5 °C (±1.0 °C - ±10.0 °C)
RH Alarm	± 0% (±3% - ±15%)
Alarm Delay	15 min (0 - 15 min)
Ring Back	30 min (0. OFF 1 - 99 min)
Door Alarm Delay	2 min (0 - 15 min)
Door Ring Back	0 min (0. OFF 1 - 99 min)

The settable range:

- Automatic set temperature alarm (Temp Alarm): ±1.0 °C~±10.0 °C.
- Automatic set humidity alarm (RH Alarm): ±3 %R.H.~±15 %R.H..
- Automatic set temperature alarm delay time (Alarm Delay): 0 minute~15 minutes.
- Alarm resume time (Ring Back): 1 minute~99 minutes, or OFF.
- Door alarm delay time (Door Alarm Delay): 0 minute~15 minutes.
- Door alarm resume time (Door Ring Back): 1 minute~99 minutes, or OFF.

Key lock password setting (Tools/Key Lock PW Setting)

1. Select "Key Lock PW Setting" in the Select Tools screen. Press the menu button (MENU) to show the menu window. Select "OK" and press the enter key (ENTER).

Select Tools MLR-352H	MENU
Log	OK
Date Time	Svc
Alarm Setting	Cancel
Key Lock PW Setting	
Default Setting	
Delete User Data	

2. Input the Current User Password (4 digits). Select "OK" and press the enter key (ENTER). The default User Password when shipped from the factory is "0000".

Key Lock PW Setting
Current User Password [REDACTED]

3. Input New User Password (4 digits). Select "OK" and press the enter key (ENTER).

Key Lock PW Setting
New User Password [REDACTED]

4. Input User Password (4 digits) again. Select "OK" and press the enter key (ENTER).

Key Lock PW Setting
New User Password x x x x
Re Enter User Password [REDACTED]

VARIOUS SETTING (MENU/Tools)

Default setting (Tools/Default Setting)

1. Select "Default Setting" in the Select Tools screen. Press the menu button (MENU) to show the menu window. Select "OK", and press the enter key (ENTER).

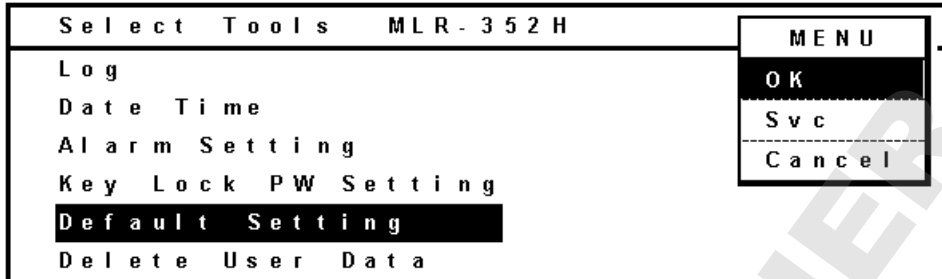

2. The Default Setting screen is displayed. Set the default for each parameter as necessary.

Default Setting	
LCD Back Color	1 (1. Blue 2. White)
DAQ Speed	0 (0.24 2.96 3.350)
DAQ ID	0 (0. OFF 1-250)
DAQ Mode	0 (0. Local 1. Remote)
Buzzer: Finished	2 (1. Yes 2. No)

LCD Back Color: Setting of background color (1. Blue 2. White)

DAQ Speed: Setting of DAQ speed. Select 0.24 (2400) that is a normal command mode. 3.350 is a special command mode for old model MLR-350.

DAQ ID: Set a no repeating ID number between 1 and 250 when an optional communication terminal.

DAQ Mode: When selecting 0.Local, the set value can be changed through Stand-by Setting and can not be changed from PC side. When selecting 1.Remote, set value can be changed from PC side and can not be changed though Stand-by Setting. DAQ mode is valid when DAQ speed is 0.24 or 2.96.

Buzzer: Finished: Select of buzzer activation (1: Yes) or no activation (2: No) at the time of completion of a programmed running. (The buzzer activates 6 times when a program is finished.)

Note:

DAQ is an external monitoring system of chamber status. Refer to DAQ operating instructions for details.

Delete of program (Tools/Delete User Data)

1. Select "Delete User Data" in the Select Tools screen. Press the menu button (MENU) to show the menu window. Select "OK", and press the enter key (ENTER).

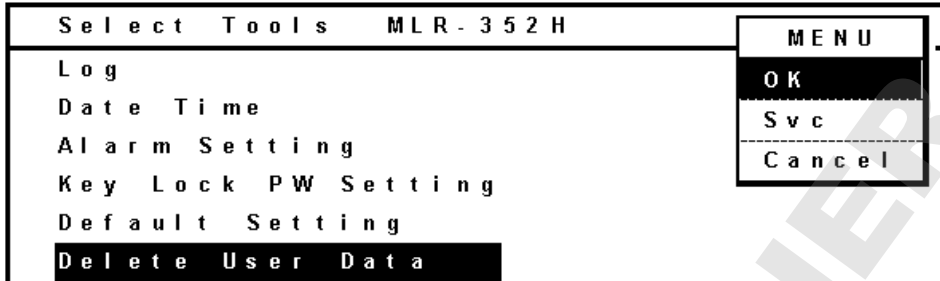

2. The Delete User Data screen is displayed. To select a program to be deleted, select "Delete a User Program" and press the menu button (MENU) to show the menu window. Select "OK" and press the enter key (ENTER).

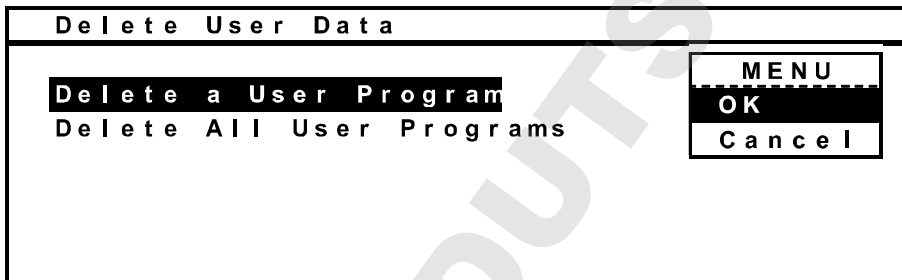

3. A list of saved programs is displayed. Select a program (Ex: Oze#1 Spring) to delete, press the menu button (MENU) to show the menu window. Select "Delete" and press the enter key (ENTER).

Program Name	Stored
Hatuga	05/04/01 15:45:00
Oze#1 Spring	05/05/01 16:4
Oze#2 Summer	05/07/01 20:4
Oze#3 Autumn	05/10/01 21:4

4. The Confirmation screen is displayed. Press the menu button (MENU) to show the menu window. Select "OK", and press the enter key (ENTER). The program (Oze#1 Spring) is now deleted.

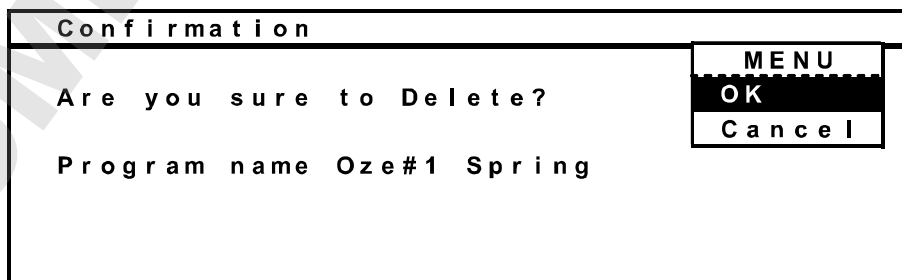

VARIOUS SETTING (MENU/Tools)

5. To deleting all programs, select "Delete All User Programs" in Delete User Data screen and press the menu button (MENU) to show the menu window. Select "OK" and press the enter key (ENTER).

Delete User Data	
Delete a User Program	MENU OK Cancel
Delete All User Programs	

6. The Confirmation screen is displayed. Press the menu button (MENU) to show the menu window. Select "OK", and press the enter key (ENTER). All of the programs are now deleted.

Confirmation	
Are you sure to delete	MENU OK Cancel
All User Programs?	

LIGHT STEP (ILLUMINANCE SETTING)

The light step is for maintaining a constant illuminance within the chamber.

The relationship between the light step (LS) and a number of fluorescent lamps to be lit is as follows:

Light Step (LS)	0	1	2	3	4	5
Fluorescent lamps to turn on	0	1	2	3	9	15

The graph below shows the relationship between the light step setting, illuminance, and photosynthetic photon flux density (PPFD) characteristics.

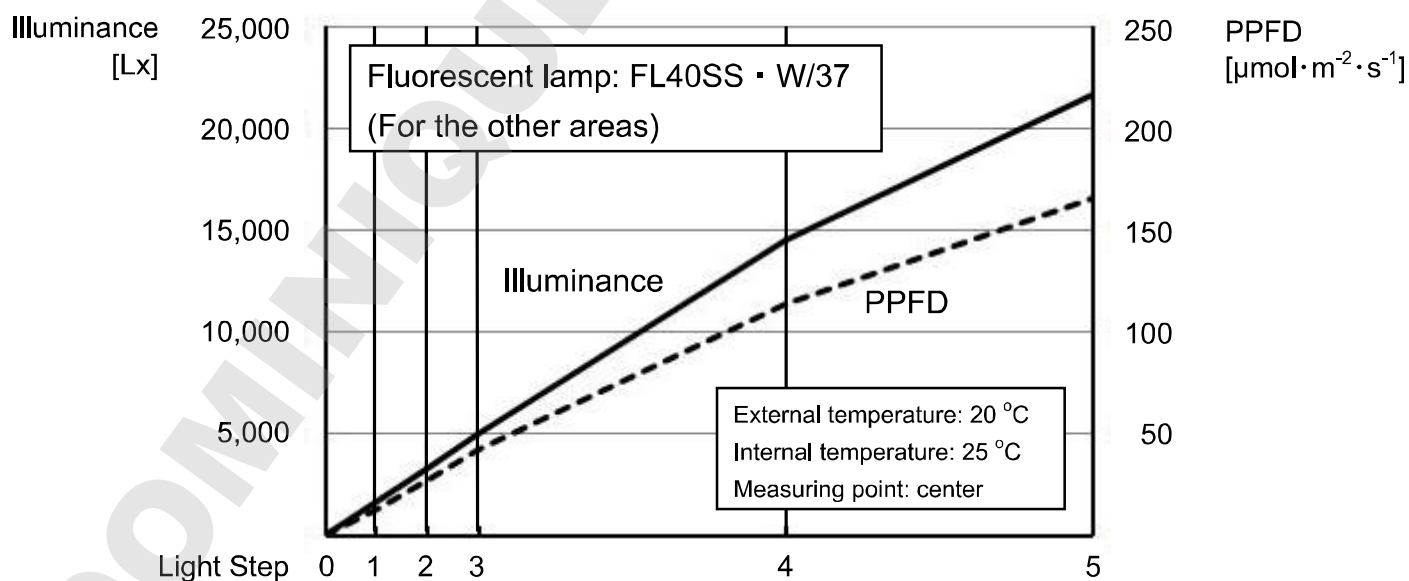
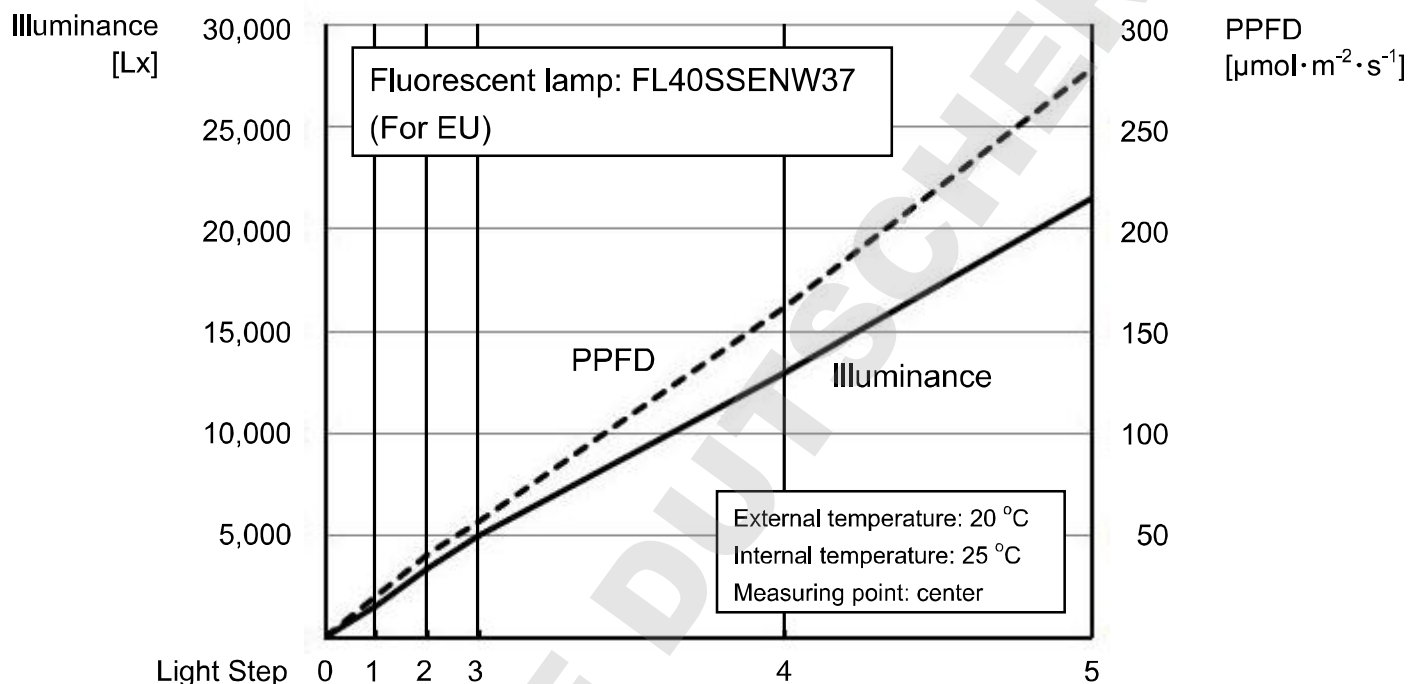

Caution:

Type of the fluorescent lamp should be FL40SSENW37 (EU) or FL40SS · W/37 (the other areas). Other type of lamp will affect on the power consumption and/or brightness.

HUMIDITY CONTROL (MLR-352H ONLY)

The chamber humidity can be set to any value within the range of 55 %R.H. to 90 %R.H.. RH though the keys on the control panel. Input of any value outside of this range is invalid.

The humidity control operates when the temperature setting is between the range 15 °C and 45 °C. The desired humidity may not be obtained if the temperature setting is outside of this range. Refer to the humidity control range below. To disable the humidity control, enter a value of 00 %R.H. as the humidity setting.

The humidity control range

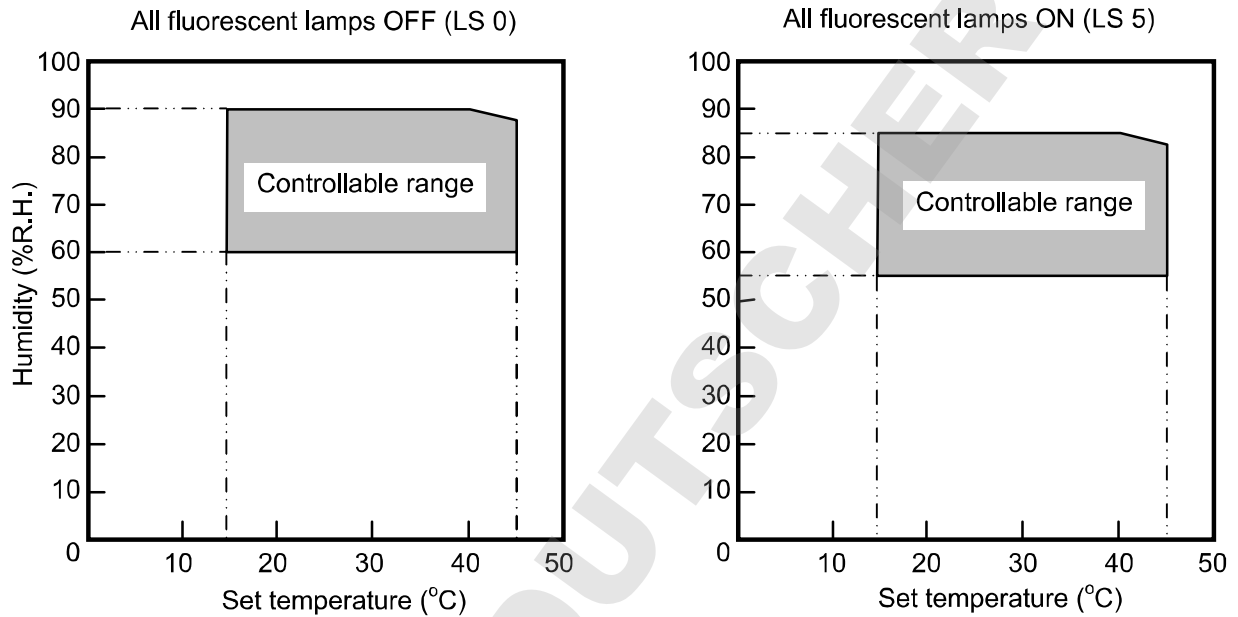

⚠ CAUTION

The humidity control is effective after the chamber temperature is stabilized between -1.5 °C and +2.5 °C of the temperature setting. The humidity display shows a value greater than the humidity setting if the chamber temperature is outside of the range. This is not a malfunction.

It takes much to reach the desired humidity if the chamber is wet or a large amount of load including humidity is placed in the chamber during low humidity operation.

ROUTINE MAINTENANCE

WARNING

Always disconnect the power supply to the unit prior to any repair or maintenance of the unit in order to prevent electric shock or injury.

Ensure you do not inhale or consume medication or aerosols from around the unit at the time of maintenance. These may be harmful to your health.

Cleaning of unit

- Clean the unit once a month. Regular cleaning keeps the unit looking new.
- Use a dry cloth to wipe off small amounts of dirt on the outside and inside of the unit and all accessories. After cleaning, wipe away the cleaner completely with a cloth washed in clean water.
- Put the removed all shelves back to the original position after cleaning. Make sure the air exhaust vent cover is set, too.
- Never splash water directly onto the unit. Deterioration of the insulation may result which could cause failure.
- The compressor and other mechanical part are completely sealed. This unit requires absolutely no lubrication.

Replacement of fluorescent lamp

Total 15 fluorescent lamps and glow starters are provided with this unit. The glow starter is located beside the each fluorescent lamp.

Type of the fluorescent lamp is FL40SSENW37 (EU) or FL40SS · W/37 (the other areas). Another type of lamp will affect on the power consumption and/or brightness.

1. Turn off the power switch, and disconnect the power supply.
2. Open the doors (front and side), take off blown lamp or glow starter.

Note:

- Take care not to injure the fingers as the bulb can be hot!
- Take care not to break the fluorescent lamp when detaching it.
- Dispose a fluorescent lamp and a glow starter in accordance with the rule or the regulation of each facility or region.

3. Set a fluorescent lamp or a glow starter.
4. Connect the power supply, and turn on the power switch.

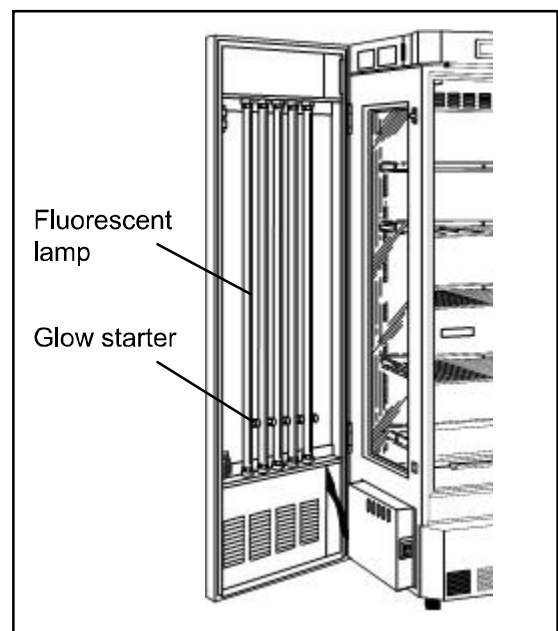

ROUTINE MAINTENANCE

Cleaning of evaporating tray

This tray catches defrosted water from evaporator and evaporates the water. Clean the tray with water twice or 3 times a year. Refer to page 10 for taking out or replacing of the tray.

Cleaning of filter

This product is provided with a condenser filter in the lower front. Clean the filter once a month since a clogged filter may cause shorter compressor life as well as the poor cooling.

1. The filter is located in the left back of the front panel as shown in Fig. 1.

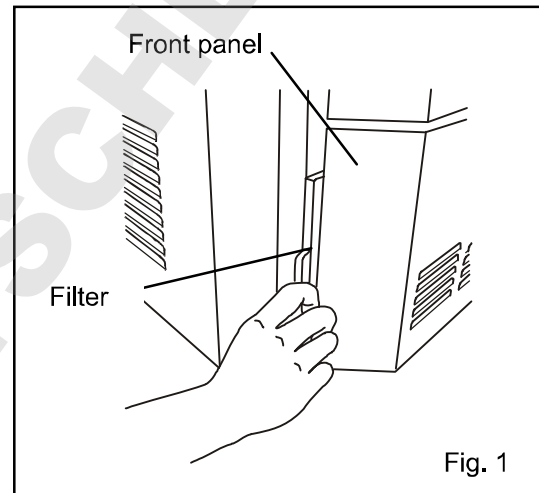

2. Takeout the filter. (Fig. 2)

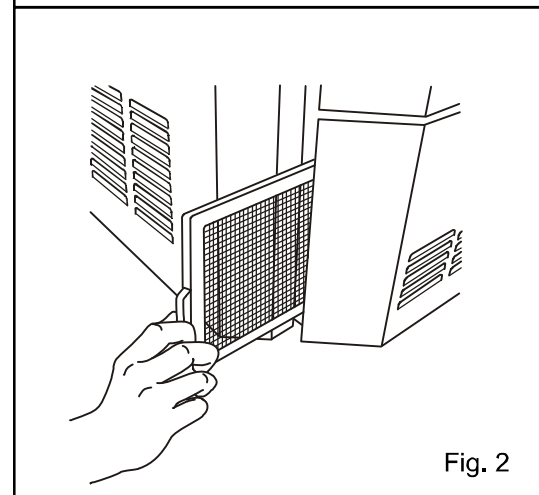

3. Clean the filter by a vacuum cleaner and replace to the original position.

Caution:

Take care to set the filter all the way seated.

ALARMS & SAFETY FUNCTIONS

Automatic set temperature alarm

The temperature alarm functions incorporated in this unit include automatic set temperature alarm other than high/low limit temperature alarm. This function operates when the chamber temperature deviates from the set value by more than the alarm temperature ($\pm 1.0\text{ }^{\circ}\text{C} \sim \pm 10.0\text{ }^{\circ}\text{C}$ changeable). This temperature alarm activates as follows during the programmed running as well. For the details, see page 54.

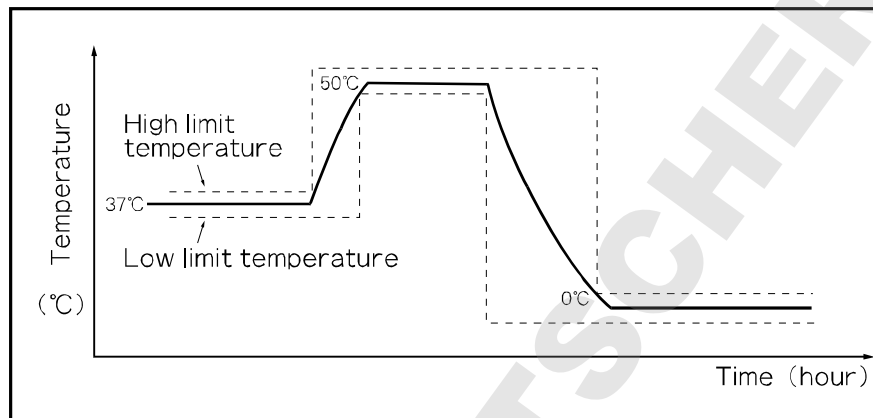

Automatic set humidity alarm (MLR-352H only)

For MLR-352H, the humidity alarm is operated when chamber humidity deviates from the set value by more than the alarm humidity ($\pm 3\text{ \%R.H.} \sim \pm 15\text{ \%R.H.}$ changeable). For the details, see page 54.

Safety functions

The unit has not only some alarm functions but also safety functions to keep the desired chamber condition. The details of the safety functions, see page 54, 55.

Operation after power failure

The set value is memorized by nonvolatile memory. Accordingly, the chamber resumes the operation with setting before power failure. During the power failure, the clock function is operating.

- In the clock mode, the operation resumes from the step (date and time) when power is recovered. Accordingly, the running step may be shorter than program.
- In the timer mode, the operation resumes with remained time before power failure. The time during power failure is not counted.

ALARMS & SAFETY FUNCTIONS

This unit has the alarms and safety functions shown below, and also self diagnostic functions.

Alarms & safety	Situation	Indication	Buzzer	Safety operation
Automatic set temperature alarm	The chamber temp. is out of the set value ± 2.5 °C. (± 1.0 °C \sim ± 10.0 °C changeable) Chamber temp. exceeds 20 °C in during defrosting	The current chamber temp. in the top screen blinks.	Intermittent tone with the alarm delay time delay	Remote alarm with alarm delay time delay. High alarm; heater OFF Low alarm; Compressor and condensing fan motor OFF
Automatic set humidity alarm (MLR-352H only)	The chamber humidity is out of the set value ± 10 %R.H.. (± 3 %R.H. \sim ± 15 %R.H. changeable)	The current chamber humidity in the top screen blinks	---	---
High limit temperature alarm	The chamber temp. exceeds the high limit temp. alarm set value (15 °C \sim 55 °C changeable).	—	Continuous tone	Heater and fluorescent lamp OFF Remote alarm
Low limit temperature alarm	The chamber temp. exceeds the low limit alarm temp. set value. (-10 °C \sim 25 °C changeable).	—	Continuous tone	Compressor and condensing fan motor OFF Remote alarm
Power failure alarm	When the power to the unit is disconnected or power switch is turned OFF.	—	---	Remote alarm.
Thermal fuse	Chamber temp. exceeds 70 °C	—	---	Fusing Heater OFF
Thermal sensor abnormality	Input voltage is lower than suitability of -50 °C	"Error 01: Temp sensor is opened." is displayed in the top screen.	Intermittent tone	Heater, Fluorescent lamp, condensing fan motor and compressor OFF Remote alarm
	Input voltage is higher than suitability of 70 °C	"Error 02: Temp sensor is shorted" is displayed in the top screen.		
Humidity sensor abnormality (MLR-352H only)	Input voltage is lower than suitability of 5 %R.H..	"Error 03: RH sensor level is low." is displayed in the top screen.	Intermittent tone	Humidity control OFF Remote alarm
	Input voltage is higher than suitability of 120 %R.H..	"Error 04: RH sensor level is over" is displayed in the top screen.		
Filter alarm	The suction temp. of the filter is higher than 50 °C or less.	"Filter" is displayed in the top screen.	—	—
Defrost sensor (main evaporator) abnormality	The sensor resistance corresponds to -50 °C or less.	"Error 05: Def sensor is opened" is displayed in the top screen.	Intermittent tone	Main heater OFF (when the chamber temp. reaches 16 °C) Remote alarm
	The sensor resistance corresponds to 70 °C or more.	"Error 06: Def sensor is shorted" is displayed in the top screen.		

Alarms & safety	Situation	Indication	Buzzer	Safety operation
Defrost sensor (sub evaporator) Abnormality (MLR-352H only)	The sensor resistance corresponds to -50 °C or less.	"Error 07: Def.S sensor is opened" is displayed in the top screen.	Intermittent tone	Sub evaporator heater OFF Defrost OFF Remote alarm
	The sensor resistance corresponds to 70 °C or more.	"Error 08: Def.S sensor is shorted" is displayed in the top screen.		
Filter sensor abnormality	The sensor resistance corresponds to -50 °C or less.	"Error 11: Filter sensor is opened" is displayed in the top screen.	Intermittent tone	Remote alarm
	The sensor resistance corresponds to 70 °C or more.	"Error 12: Filter sensor is shorted" is displayed in the top screen.		
Door alarm	The door is open during more than door delay time. (default: 2 minutes)	When door is opened; "Door" is highlighted. After door alarm delay time; "Door" is displayed alternately in normal characters and reverse video in the top screen.	Intermittent tone	When the door is opened; Inner fan OFF
Running program back-up	During power failure	—	—	Nonvolatile memory Resumes running after power recovery
Clock function back-up	During power failure	—	—	Continuous running by a battery (CR2032)
Inner fan motor alarm	The inner fan motor breaks down.	"Error 09: Cooling fan motor trouble" is displayed in the top screen.	Intermittent tone	Heater, fluorescent lamp, condensing fan motor and compressor OFF Remote alarm
Condensing fan motor alarm	The condensing fan motor breaks down.	"Error 10: Condensing fan motor trouble" is displayed in the top screen.	Intermittent tone	Heater, fluorescent lamp and compressor OFF Remote alarm

Note:

- The buzzer of alarms other than the high limit temperature alarm and the low limit temperature alarm can be silenced by pressing the alarm buzzer stop key (BUZZER).
- The buzzer will be activated again after the certain suspension if the alarm condition is continued after silencing the buzzer. The suspension time after silencing the buzzer and before resuming the buzzer can be set by "Ring Back". Refer to page 44.
- The buzzer will be activated again after the certain suspension if the door is kept opened, after silencing the buzzer. The suspension time after silencing the buzzer and before resuming the buzzer can be set by "Door ring Back". Refer to page 44.
- To stop the buzzer of the high limit temperature alarm and the low limit temperature alarm, change the setting temperature of each alarm to avoid the current operating temperature. Need to be set them beyond ± 5 °C of operating temperature range.

TROUBLESHOOTING

If the unit malfunctions, check out the following before calling for service.

Malfunction	Check/Remedy
Nothing operates even when switched on	<ul style="list-style-type: none"> ▪ The unit is not connected to the power supply or capacity of power source is not enough. ▪ There is a power failure, the fuse is blown, or the circuit breaker is activated.
Alarm is activated	<ul style="list-style-type: none"> ▪ Chamber temperature exceeds high limit/low limit temperature alarm temperature. In this case, check the chamber temperature setting, and high/low limit temperature alarm. When the chamber temperature is not set between high and low limit temperature alarm, it is necessary to reset either high or low limit alarm temperature. ▪ A lot of heat load is placed in the chamber at once. In this case, the alarm is eliminated when the chamber temperature goes down. ▪ There is a excessive heat source in the chamber. Refer to next page for the acceptable limits for heat load in the chamber. ▪ Is the unit operating beside the appliance that generates the electromagnetic wave?
The temperature is not changed according to a program	<ul style="list-style-type: none"> ▪ The programmed temperature variation is over the pull up/pull down performance of the unit. The performance of the unit is shown on next page. It takes much time to pull up/pull down when some items are placed in the chamber. Set a program taking the performance into consideration. ▪ The setting of high/low limit temperature alarm is not correct. ▪ Is the unit operating beside the appliance that generates the electromagnetic wave?

Note:

If the malfunction is not eliminated after checking the above items, or the malfunction is not shown in the above table, contact our sales representative or agent.

Keep an electric product which emits an electromagnetic wave away from this product. A noise from an electromagnetic wave may cause malfunction of the product.

DISPOSAL OF UNIT

WARNING

If the unit is to be stored unused in an unsupervised area for an extended period **ensure that children do not have access and doors cannot be closed completely.**

The disposal of the unit should be accomplished by appropriate personnel. Always remove doors to prevent accidents such as suffocation.

DOMINIQUE DUTSCHER SAS

DISPOSAL OF UNIT

Note:

This symbol mark and recycle system are applied only to EU countries and not applied to the countries in the other area of the world.

Waste Electrical and Electronic Equipment (WEEE) Directive-2002/96/EC

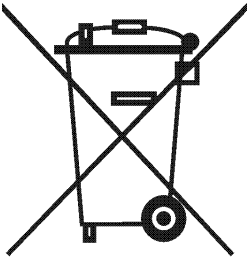

(English)

Your Panasonic product is designed and manufactured with high quality materials and components which can be recycled and reused.

This symbol means that electrical and electronic equipment, at their end-of-life, should be disposed of separately from your household waste.

Please dispose of this equipment at your local community waste collection/recycling centre.

In the European Union there are separate collection systems for used electrical and electronic products.

Please help us to conserve the environment we live in!

(German)

Ihr Panasonic Produkt wurde entworfen und hergestellt mit qualitativ hochwertigen Materialien und Komponenten, die recycelt und wiederverwendet werden können.

Dieses Symbol bedeutet, daß elektrische und elektronische Geräte am Ende ihrer Nutzungsdauer von Hausmüll getrennt entsorgt werden sollen.

Bitte entsorgen Sie dieses Gerät bei Ihrer örtlichen kommunalen Sammelstelle oder im Recycling Centre.

In der Europäischen Union gibt es unterschiedliche Sammelsysteme für Elektrik- und Elektronikgeräte.

Helfen Sie uns bitte, die Umwelt zu erhalten, in der wir leben!

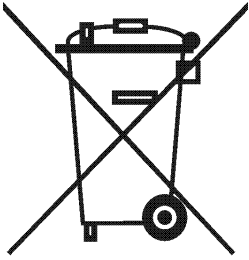

(French)

Votre produit Panasonic est conçu et fabriqué avec des matériels et des composants de qualité supérieure qui peuvent être recyclés et réutilisés.

Ce symbole signifie que les équipements électriques et électroniques en fin de vie doivent être éliminés séparément des ordures ménagères.

Nous vous prions donc de confier cet équipement à votre centre local de collecte/recyclage. Dans l'Union Européenne, il existe des systèmes sélectifs de collecte pour les produits électriques et électroniques usagés.

Aidez-nous à conserver l'environnement dans lequel nous vivons !

Les machines ou appareils électriques et électroniques contiennent fréquemment des matières qui, si elles sont traitées ou éliminées de manière inappropriée, peuvent s'avérer potentiellement dangereuses pour la santé humaine et pour l'environnement.

Cependant, ces matières sont nécessaires au bon fonctionnement de votre appareil ou de votre machine. Pour cette raison, il vous est demandé de ne pas vous débarrasser de votre appareil ou machine usagé avec vos ordures ménagères.

(Spanish)

Los productos Panasonic están diseñados y fabricados con materiales y componentes de alta calidad, que pueden ser reciclados y reutilizados.

Este símbolo significa que el equipo eléctrico y electrónico, al final de su ciclo de vida, no se debe desechar con el resto de residuos domésticos.

Por favor, deposite su viejo "televisor" en el punto de recogida de residuos o contacte con su administración local.

En la Unión Europea existen sistemas de recogida específicos para residuos de aparatos eléctricos y electrónicos.

Por favor, ayúdenos a conservar el medio ambiente!

DISPOSAL OF UNIT

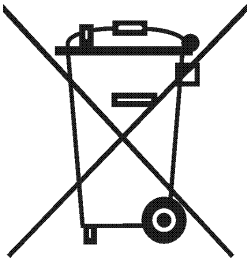

(Portuguese)

O seu produto Panasonic foi concebido e produzido com materiais e componentes de alta qualidade que podem ser reciclados e reutilizados.

Este símbolo significa que o equipamento eléctrico e electrónico no final da sua vida útil deverá ser descartado separadamente do seu lixo doméstico.

Por favor, entregue este equipamento no seu ponto local de recolha/reciclagem.

Na União Europeia existem sistemas de recolha separados para produtos eléctricos e electrónicos usados.

Por favor, ajude-nos a conservar o ambiente em que vivemos!

(Italian)

Il vostro prodotto Panasonic è stato costruito da materiali e componenti di alta qualità, che sono riutilizzabili o riciclabili.

Prodotti elettrici ed elettronici portando questo simbolo alla fine dell'uso devono essere smaltiti separatamente dai rifiuti casalinghi.

Vi preghiamo di smaltire questo apparecchio al deposito comunale.

Nell'Unione Europea esistono sistemi di raccolta differenziata per prodotti elettrici ed elettronici.

Aiutateci a conservare l'ambiente in cui viviamo!

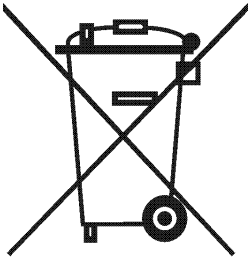

(Dutch)

Panasonic producten zijn ontwikkeld en gefabriceerd uit eerste kwaliteit materialen, de onderdelen kunnen worden gerecycled en weer worden gebruikt.

Het symbool betekent dat de elektrische en elektronische onderdelen wanneer deze vernietigd gaan worden, dit separaat gebeurt van het normale huisafval.

Zorg ervoor dat het verwijderen van de apparatuur bij de lokaal erkende instanties gaat gebeuren. In de Europese Unie wordt de gebruikte elektrische en elektronische apparatuur bij de daarvoor wettelijke instanties aangeboden.

Alstublieft help allen mee om het milieu te beschermen.

(Swedish)

Din Panasonic produkt är designad och tillverkad av material och komponenter med hög kvalitet som kan återvinnas och återanvändas.

Denna symbol betyder att elektriska och elektroniska produkter, efter slutanvändande, skall sorteras och lämnas separat från Ditt hushållsavfall.

Vänligen, lämna denna produkt hos Din lokala mottagningstation för avfall/återvinningsstation.

Inom den Europeiska Unionen finns det separata återvinningssystem för begagnade elektriska och elektroniska produkter.

Vänligen, hjälp oss att bevara miljön vi lever i!

PERFORMANCE DATA (MLR-352H)

1. Pull down, pull up performance (The chamber temperature of center)

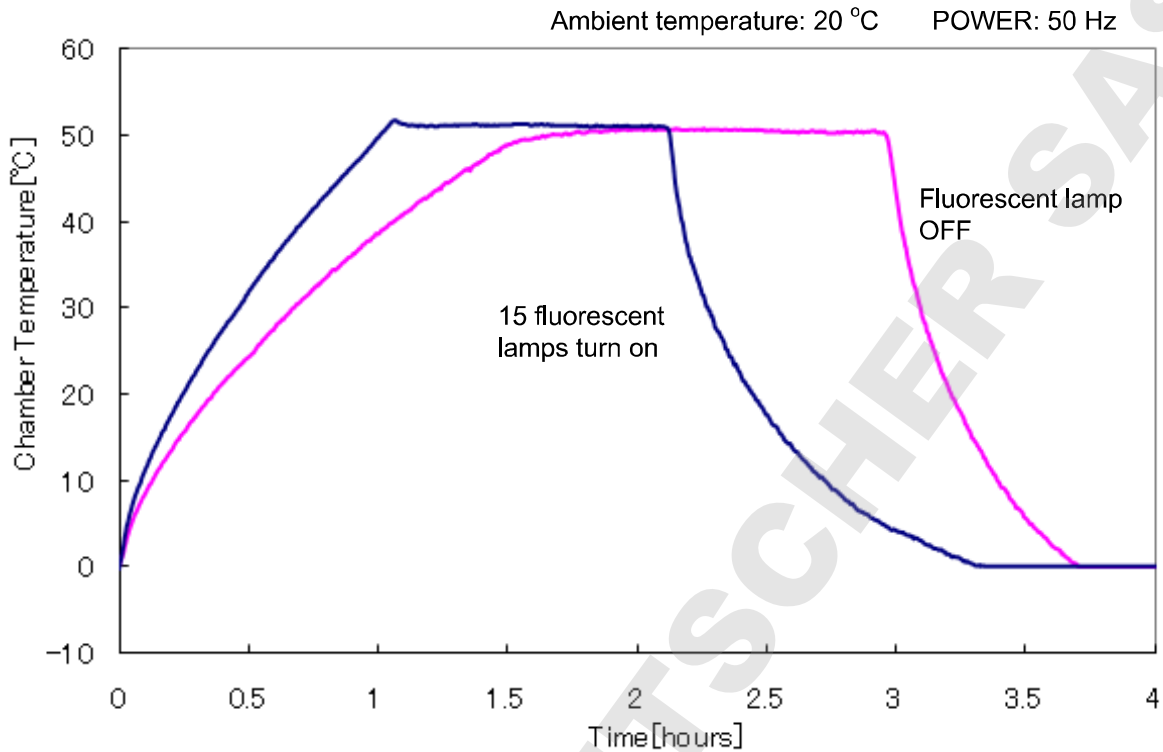

2. Acceptable heat load inside a chamber

The maximum heat load being possible to maintain the setting temperature varies depending on the ambient temperature and the number of fluorescent lamp lighting. Refer to the following graph and observe the heat load permitted within the chamber.

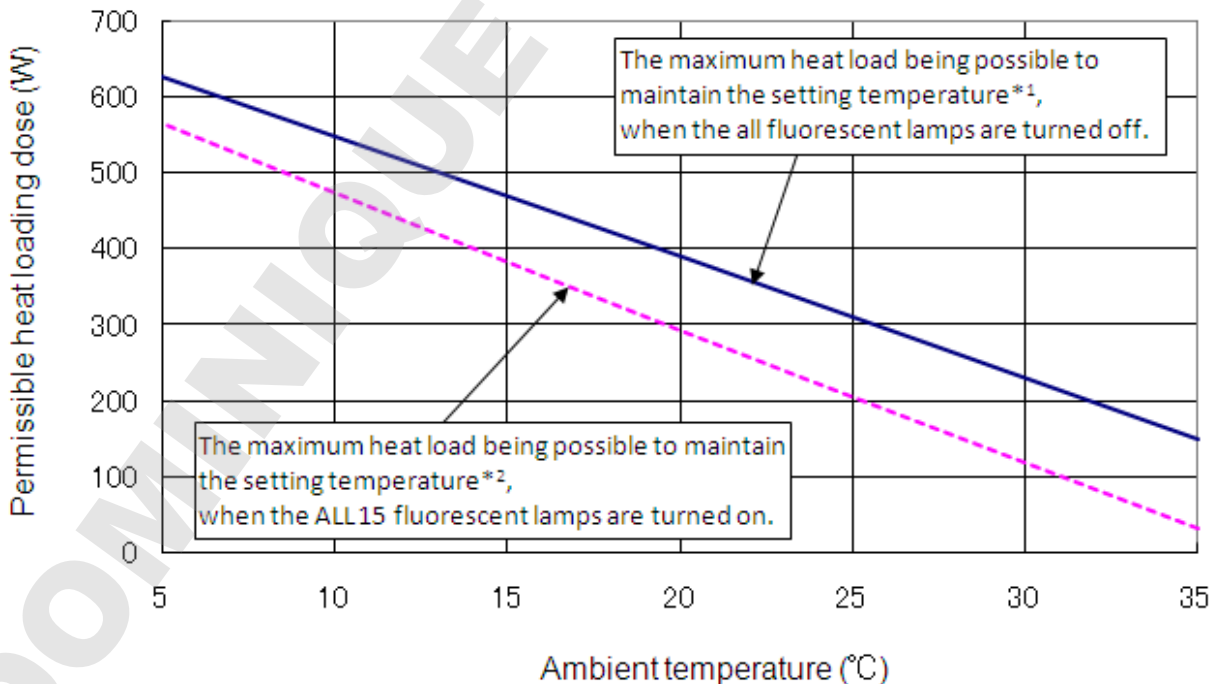

*1: When the setting temperature is higher than 5 °C or more. If not, the chamber temperature may not reach the setting temperature.

*2: When the setting temperature is higher than 10 °C or more. If not, the chamber temperature may not reach the setting temperature.

SPECIFICATIONS

Product name	Versatile Environmental Test Chamber MLR-352	Versatile Environmental Test Chamber MLR-352H
External dimensions	W760 mm x D700 mm x H1835 mm	
Internal dimensions	W520 mm x D490 mm x H1135 mm	
Effective capacity	294 L	
Exterior	Painted steel	
Interior	Stainless steel, Paired glass window on right and left side (370 mm x 1110 mm)	
Door	Painted steel, front, left, and right side	
Inner door	Paired glass	
Insulation	Rigid polyurethane foamed-in place	
Shelf	Hard steel wire on polyester coating, 4 pcs. Inner dimension; W465 mm x D450 mm, Maximum load; 25 kg/shelf Hard steel wire on polyester coating with stainless cover, 1 pc. (bottom) Inner dimension; W355 mm x D395 mm, Maximum load; 25 kg/shelf	
Access port	Inner diameter; 40 mm, Top left side	
Heating and cooling method	Forced air circulation	
Compressor	Hermetic type, Output; 250 W	
Evaporator	Fin and tube type	
Condenser	Fin and tube type	
Refrigerant	R-404A	
Defrosting	Automatic defrost (3 patterns), Manual defrost	
Heater	334 W	381 W
Temperature controller	Electric heat apparatus: PID control, Compressor: ON-OFF control	
Temperature display	Digital display	
Humidity controller	--	Electronic expansion valve: PID control Humidifier: PI control
Humidity display	--	Digital display
Alarms and safety functions	Automatic set temperature alarm, High/Low limit temperature alarm, Filter alarm, Temperature/Filter/Defrost (main evaporator) sensor alarm, Inner/Condensing fan motor alarm, Door alarm, Thermal fuse, Memory back-up	
	---	Automatic set humidity alarm, Humidity sensor alarm Defrost (sub evaporator) sensor alarm
Remote alarm contact	DC 30 V, 2 A	
Program function	Temperature, illuminance	Temperature, illuminance, humidity
	12 steps (10 patterns), 98 cycle or limitless Clock mode: 00:00~23:59 Timer mode: 00:01~99:59	
Overcurrent protector	Rated current: 25 A	
Accessories	4 upper shelves, 1 bottom shelf, 1 air exhaust vent cover	4 upper shelves, 1 bottom shelf, 1 air exhaust vent cover, 1 water supply tank, 1 supply hose
Weight	226 kg	235 kg
Option	Data acquisition system (MTR-5000) Interface board (MTR-L03), Interface board (MTR-480)	

Note: Refer to the updated catalog when ordering an optional component.

Designs and specifications are subject to change without notice.

PERFORMANCE

Product name	Versatile Environmental Test Chamber MLR-352		
Model No.	MLR-352-PK	MLR-352-PB	MLR-352-PE
Temperature setting range	0 °C to +50 °C		
Temperature control range	+10 °C to +50 °C (light ON), 0 °C to +50 °C (light OFF)		
Temperature distribution	±3.5 °C (light ON), ±1.5 °C (light OFF) (Ambient temperature: 20 °C, no load) ±2.5 °C (light ON), ±1.0 °C (light OFF) (Set temperature: 25 °C, ambient temperature: 20 °C, no load)		
Temperature fluctuation	±0.3 °C (Set temperature: 25 °C, ambient temperature: 20 °C, no load)		
Fluorescent light	40 W x 15 (FL40SS · W/37) Glow starter x 15 (FG-4P)	40 W x 15 (FL40SSEW37) Glow starter x 15 (FG-4P)	
Brightness control range	0~20000 Lx (Photosynthetic photon flux density: 150 $\mu\text{mol} \cdot \text{m}^{-2} \cdot \text{s}^{-1}$) 6 steps changeable	0~20000 Lx (Photosynthetic photon flux density: 250 $\mu\text{mol} \cdot \text{m}^{-2} \cdot \text{s}^{-1}$) 6 steps changeable	
Usable ambient temperature	+5 °C to +35 °C, Less than 80 %R.H.		
Noise level	47 dB (light ON) / 45 dB (light OFF) (A scale)		
Maximum pressure	2950 kPa		
Rated voltage	AC 220 V		AC 230 V/240 V
Rated frequency	60 Hz	50 Hz	
Power consumption	1440 W	1300 W	1400 W/1500 W

Product name	Versatile Environmental Test Chamber MLR-352H			
Model No.	MLR-352H-PA	MLR-352-PK	MLR-352H-PB	MLR-352H-PE
Temperature setting range	0 °C to +50 °C			
Temperature control range	+10 °C to +50 °C (light ON), +5 °C to +50 °C (light OFF)			
Temperature distribution	±3.5 °C (light ON), ±1.5 °C (light OFF) (Ambient temperature: 20 °C, no load) ±2.5 °C (light ON), ±1.0 °C (light OFF) (Set temperature: 25 °C, ambient temperature: 20 °C, no load)			
Temperature fluctuation	±0.3 °C (Set temperature: 25 °C, ambient temperature: 20 °C, no load)			
Fluorescent light	40 W x 15 (FL40SS · W/37) Glow starter x 15 (FG-4P)		40 W x 15 (FL40SSEW37) Glow starter x 15 (FG-4P)	
Brightness control range	0~20000 Lx (Photosynthetic photon flux density: 150 $\mu\text{mol} \cdot \text{m}^{-2} \cdot \text{s}^{-1}$) 6 steps changeable		0~20000 Lx (Photosynthetic photon flux density: 250 $\mu\text{mol} \cdot \text{m}^{-2} \cdot \text{s}^{-1}$) 6 steps changeable	
Humidity setting range	55 %R.H. to 90 %R.H. or OFF			
Humidity control range	60 %R.H. to 90 %R.H. (at LS: 0 and Temperature: +15 °C to +45 °C) 55 %R.H. to 85 %R.H. (at LS: 5 and Temperature: +15 °C to +45 °C)			
Usable ambient temperature	+5 °C to +35 °C, Less than 80 %R.H.			
Noise level	47 dB (light ON) / 45 dB (light OFF) (A scale)			
Maximum pressure	2950 kPa			
Rated voltage	AC 115 V	AC 220 V		AC 230 V/240 V
Rated frequency	60 Hz		50 Hz	
Power consumption	1450 W	1450 W	1310 W	1500 W/1550 W

Note: Design or specification will be subject to change without notice.

The unit with CE mark complies with EC directives.

CAUTION

Please fill in this form before servicing.
Hand over this form to the service engineer to keep for his and your safety.

Safety check sheet

1. Chamber contents :

- Risk of infection: Yes No
Risk of toxicity: Yes No
Risk from radioactive sources: Yes No

(List all potentially hazardous materials that have been stored in this unit.)

Notes :

2. Contamination of the unit

Unit interior

- No contamination Yes No
Decontaminated Yes No
Contaminated Yes No

Others:

3. Instructions for safe repair/maintenance of the unit

- a) The unit is safe to work on Yes No
b) There is some danger (see below) Yes No

Procedure to be adhered to in order to reduce safety risk indicated in b) below.

Date :

Signature :

Address, Division :

Telephone :

Product name: Versatile Environmental Test Chamber	Model No. MLR-	Serial number:	Date of installation:
--	-------------------	----------------	-----------------------

Please decontaminate the unit yourself before calling the service engineer.

DOMINIQUE DUTSCHER SAS

Panasonic Healthcare Co., Ltd.

1-1-1 Sakata, Oizumi-Machi, Ora-Gun, Gunma 370-0596, Japan

© Panasonic Healthcare Co., Ltd. 2012

Printed in Japan
7FB6P151616002
S0512-20812