

Panasonic®

Operating Instructions

Ultra-Low Temperature Freezer

MDF-1156

MDF-1156ATN

MDF-1156

MDF-1156ATN Series



Please read these instructions carefully before using this product, and save this operating instructions for future use.

See page 30 for all Model numbers.

CONTENTS

INTRODUCTION	P. 2
PRECAUTIONS FOR SAFE OPERATION	P. 3
ENVIRONMENTAL CONDITIONS	P. 7
FREEZER COMPONENTS	P. 8
Control panel	P. 10
INSTALLATION SITE	P. 11
INSTALLATION	P. 12
START-UP OF UNIT	P. 13
CHAMBER TEMPERATURE SETTING	P. 14
REMOTE ALARM TERMINAL	P. 14
ALARM TEMPERATURE SETTING	P. 15
SETTING OF ALARM RESUME TIME	P. 16
ALARMS & SAFETY FUNCTIONS	P. 17
ROUTINE MAINTENANCE	P. 18
Cleaning of cabinet	P. 18
Cleaning of condenser filter	P. 18
Defrosting of inside wall	P. 19
TROUBLESHOOTING	P. 20
DISPOSAL OF UNIT	P. 21
Recycle of battery	P. 21
Decontamination of unit	P. 21
DISPOSAL OF BATTERY	P. 26
TEMPERATURE RECORDER	P. 27
BACKUP COOLING KIT	P. 28
SPECIFICATIONS	P. 29
PERFORMANCE	P. 30
SAFETY CHECK SHEET	P. 31

INTRODUCTION

- Read this operating instructions carefully before using the appliance and follow the instructions for safety operation.
- Our company never guarantee any safety if the appliance is used for any objects other than intended use or used by any procedures other than those mentioned in this operating instructions.
- Keep this operating instructions in an adequate place to refer to it as necessary.
- The contents of the operating instructions will be subjected to change without notice due to the improvement of performance or functions.
- Contact our sales representative or agent if any page of the operating instructions is lost or page order is incorrect.
- Contact our sales representative or agent if any point in this operating instructions is unclear or if there are any inaccuracies.
- No part of this operating instructions may be reproduced in any form without the expressed written permission of our company.

CAUTION

Our company guarantees the product under certain warranty conditions. Our company in no way shall be responsible for any loss of content or damage of content.

PRECAUTIONS FOR SAFE OPERATION

It is imperative that the user complies with this operating instructions as it contains important safety advice.

Items and procedures are described so that you can use this unit correctly and safely. If the precautions advised are followed, this will prevent possible injury to the user and any other person.

Precautions are illustrated in the following way:



WARNING

Failure to observe WARNING signs could result in a hazard to personnel possibly resulting in serious injury or death.

CAUTION

Failure to observe CAUTION signs could result in injury to personnel and damage to the unit and associated property.

Symbol shows;

-  this symbol means caution.
-  this symbol means an action is prohibited.
-  this symbol means an instruction must be followed.

Be sure to keep this operating instructions in a place accessible to users of this unit.

< Label on the unit >



This mark is labeled on the cover in which the electrical components of high voltage are enclosed to prevent the electric shock.

The cover should be removed by a qualified engineer or a service personnel only.

WARNING

As with any equipment that uses CO₂ or N₂ gas, there is a likelihood of oxygen depletion in the vicinity of the equipment. It is important that you assess the work site to ensure there is suitable and sufficient ventilation. If restricted ventilation is suspected, then other methods of ensuring a safe environment must be considered. These may include atmosphere monitoring and warning devices.













PRECAUTIONS FOR SAFE OPERATION

WARNING

-  **Do not use the unit outdoors.** Current leakage or electric shock may result if the unit is exposed to rain water.
-  **Only qualified engineers or service personnel should install the unit.** The installation by unqualified personnel may cause electric shock or fire.
-  **Install the unit on a sturdy floor and take an adequate precaution to prevent the unit from turning over.** If the floor is not strong enough or the installation site is not adequate, this may result in injury from the unit falling or tipping over.
-  **Never install the unit in a humid place or a place where it is likely to be splashed by water.** Deterioration of the insulation may result which could cause current leakage or electric shock.
-  **Never install the unit in a flammable or volatile location.** This may cause explosion or fire.
-  **Never install the unit where acid or corrosive gases are present** as current leakage or electric shock may result due to corrosion.
-  **Always ground (earth) the unit to prevent electric shock.** If the power supply outlet is not grounded, it will be necessary to install a ground by qualified engineers.
-  **Never ground the unit through a gas pipe, water main, telephone line or lightning rod.** Such grounding may cause electric shock in the case of an incomplete circuit.
-  **Connect the unit to a power source as indicated on the rating label attached to the unit.** Use of any other voltage or frequency other than that on the rating label may cause fire or electric shock.
-  **Never store volatile or flammable substances** in this unit if the container cannot be sealed. These may cause explosion or fire.
-  **Do not insert metal objects such as a pin or a wire into any vent, gap or any outlet on the unit.** This may cause electric shock or injury by accidental contact with moving parts.
-  **Use this unit in safe area when treating the poison, harmful or radiate articles.** Improper use may cause bad effect on your health or environment.
-  **Turn off the power switch (if provided) and disconnect the power supply to the unit prior to any repair or maintenance** of the unit in order to prevent electric shock or injury.
-  **Do not touch any electrical parts (such as power supply plug) or operate switches with a wet hand.** This may cause electric shock.







PRECAUTIONS FOR SAFE OPERATION

WARNING

-  **Ensure you do not inhale or consume medication or aerosols** from around the unit at the time of maintenance. These may be harmful to your health.
-  **Never splash water directly onto the unit** as this may cause electric shock or short circuit.
-  **Never put containers with liquid on the unit** as this may cause electric shock or short circuit when the liquid is spilled.
-  **Never bind, process, or step on the power supply cord, or never damage or break the power supply plug.** A broken supply cord or plug may cause fire or electric shock.
-  **Do not use the supply cord if its plug is loose.** Such supply cord may cause fire or electric shock.
-  **Never disassemble, repair, or modify the unit yourself.** Any such work carried out by an unauthorized person may result in fire, or electric shock or injury due to a malfunction.
-  **Disconnect the power supply plug if there is something wrong with the unit.** Continued abnormal operation may cause electric shock or fire.
-  **When removing the plug from the power supply outlet, grip the power supply plug, not the cord.** Pulling the cord may result in electric shock or fire by short circuit.
-  **Disconnect the power supply plug** before moving the unit. Take care not to damage the power cord. A damaged cord may cause electric shock or fire.
-  **Disconnect the power plug when the unit is not used for long periods.** Keeping the connection may cause electric shock, current leakage, or fire due to the deterioration of insulation.
-  If the unit is to be stored unused in an unsupervised area for an extended period, **ensure that children do not have access and that doors cannot be closed completely.**
-  **The disposal of the unit should be accomplished by appropriate personnel.** Remove doors to prevent accidents such as suffocation.
-  **Do not put the packing plastic bag within reach of children** as suffocation may result.

PRECAUTIONS FOR SAFE OPERATION

CAUTION

-  **Use a dedicated power source** (a dedicated circuit with a breaker) as indicated on the rating label attached to the unit. A branched circuit may cause fire resulting from abnormal heating.
-  **Connect the power supply plug to the power source firmly after removing the dust on the plug.** A dusty plug or improper insertion may cause a heat or ignition.
-  **Never store corrosive substances such as acid or alkali** in this unit if the container cannot be sealed. These may cause corrosion of inner components or electric parts.
-  **Check the setting when starting up of operation after power failure or turning off of power switch.** The stored items may be damaged due to the change of setting.
-  **Be careful not to tip over the unit** during movement to prevent damage or injury.
-  **Prepare a safety check sheet** when you request any repair or maintenance for the safety of service personnel.

ENVIRONMENTAL CONDITIONS

This equipment is designed to be safe at least under the following conditions (based on the IEC 61010-1):

- Indoor use;
- Altitude up to 2000 m;
- Ambient temperature 5°C to 40°C;
- Maximum relative humidity 80% for temperature up to 31°C decreasing linearly to 50% relative humidity at 40°C;
- Mains supply voltage fluctuations up to $\pm 10\%$ of the nominal voltage;
- Transient overvoltages up to the levels of OVERVOLTAGE CATEGORY II;
- Temporary OVERVOLTAGES occurring on the mains supply;
- Applicable pollution degree of the intended environment (POLLUTION DEGREE 2 in most cases)

FREEZER COMPONENTS

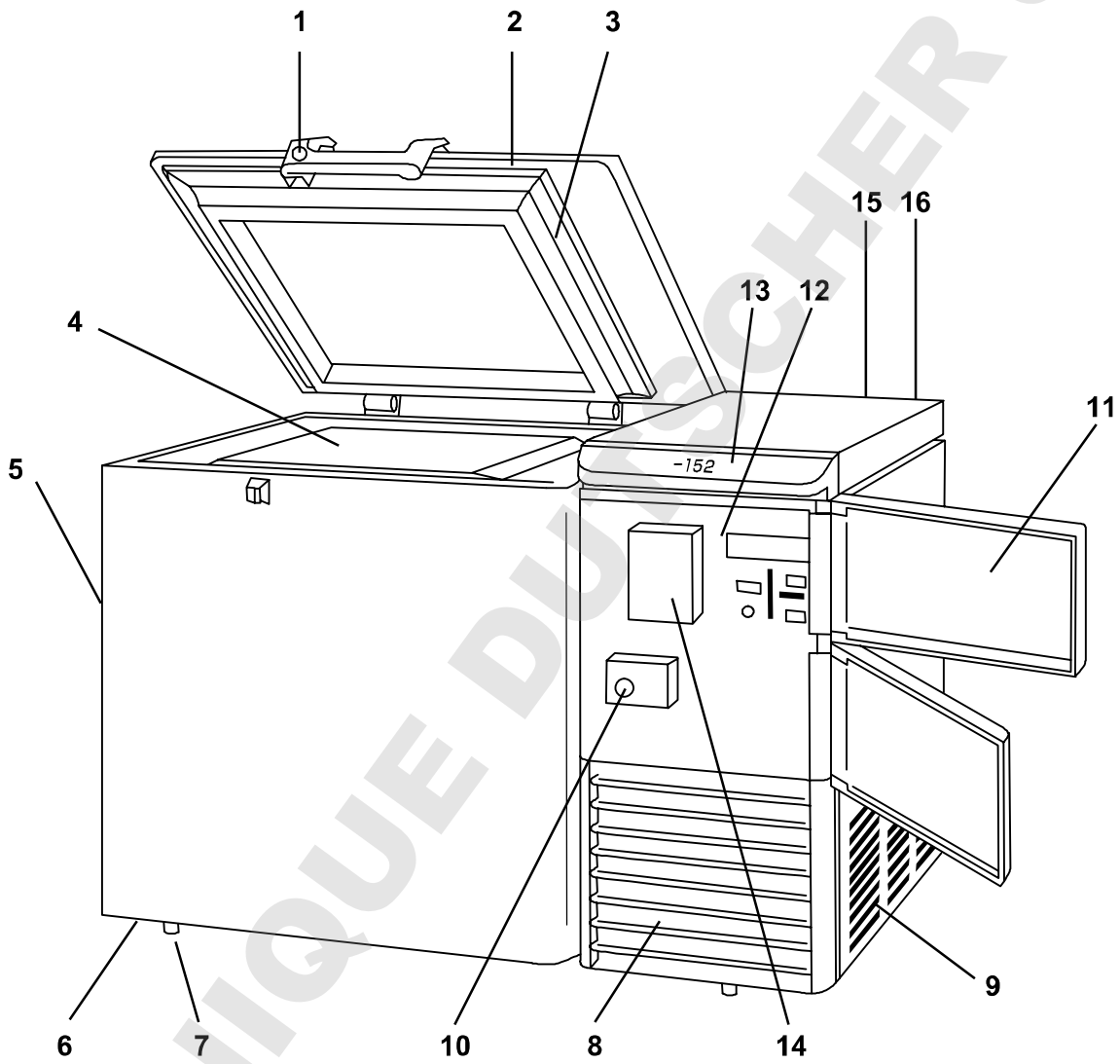

MDF-1156ATN

FREEZER COMPONENTS

1. Lock

2. Door: Hinged type. The door can be opened in any angle on the way to full open.

3. Magnetic door gasket: Seals the door and prevents leakage of cold air.

4. Inner lid: Serves as a means of reducing cold air leakage when the door is open.

5. Access port: Serves a means of leading the measuring cable from the freezer chamber to the outside.

6. Caster: 6 casters are provided. They make the moving of the unit easier.

7. Leveling foot: Serves to adjust the height and to settle the frame.

8. Grille: Acts as an inlet for air to cool the motor. Be careful not to block this. By pulling down this grille, you can clean a clogged condenser filter.

9. Exhaust air vent: Be careful not to block this.

10. Control panel cover lock: To lock the control panel cover to avoid the setting by accidental contact.

11. Control panel cover

12. Control panel: Refer to page 10.

13. Digital temperature indicator: This indicator shows the present temperature or setting temperature.

14. Temperature recorder (ATN type)

15. Remote alarm terminal: It is located inside of rear cover. Refer to page 14 "Remote alarm terminal".

16. Backup cooling kit joint (ATN type): It is positioned at rear of the unit. Serves to connect with the pipelines from the cylinder (liquid N₂) at the top right of the rear frame. Refer to page 28 "Backup cooling kit"

FREEZER COMPONENTS

Control panel

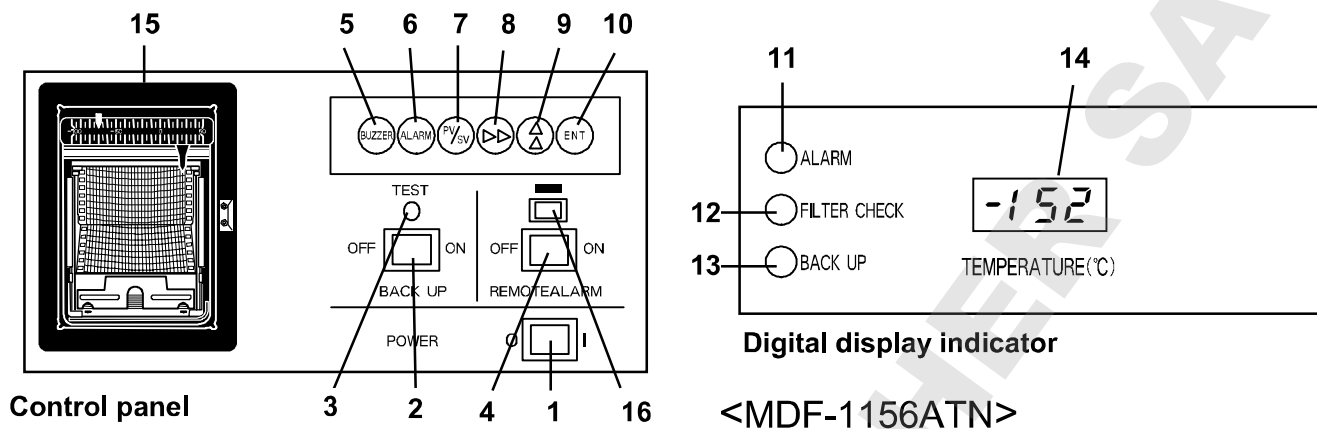

- 1. Power supply switch (POWER):** Power all functions except remote alarm and backup cooling kit for ATN type.
- 2. Backup switch (BACK UP) (ATN type):** Switch ON for operation of the backup cooling kit and switch OFF for stopping. Handle this switch according to page 28 "Backup cooling kit".
- 3. Backup test switch (TEST) (ATN type):** Examine the functions of the backup cooling kit. This switch allows liquid N₂ to spout under any circumstances. Handle it according to page 28 "Backup cooling kit".
- 4. Remote alarm switch (REMOTE ALARM):** This switch is for remote alarm. In case of operating remote alarm, turn the switch to ON.
- 5. Alarm buzzer stop key (BUZZER):** To stop the alarm from sounding, press this key. Should a further abnormality occur, the buzzer will sound automatically.
- 6. Alarm test key (ALARM):** Check that the alarm lamp and the buzzer are functional when the freezer is operating well.
- 7. Temperature setting key (PV/SV):** This key has two functions.
 PV; present freezer compartment temperature is displayed. (+50 °C to -170 °C)
 SV; setting temperature is displayed. (-130 °C to -152 °C)
 When the desired temperature is set, this key should be pressed (SV side). When no key is pressed more than 90 seconds, displayed number won't be memorized, setting will be over and digital temperature indicator will display the present value.
- 8. Digit shift key (▶▶):** The digit of the figure displayed for temperature adjustment can be shifted using this key.
- 9. Numerical value shift key (▲):** The figure that is displayed digitally can be changed by pressing this key.
- 10. Enter key (ENT):** By pressing this key in set mode, the setting is memorized and set mode is completed.
- 11. Alarm lamp (ALARM):** This lamp will flash when the unit is in alarm condition.
- 12. Filter check lamp (FILTER CHECK):** This lamp blinks and the alarm buzzer sounds when the condenser filter is clogged. Clean the condenser filter according to page 18 "Cleaning of condenser filter".
- 13. Backup lamp:** This lamp will light when the backup switch is ON. (This doesn't show the case that backup cooling kit is activated.)
- 14. Digital temperature indicator (TEMPERATURE °C):** This indicator shows the present temperature or setting temperature (flash).
- 15. Temperature recorder (ATN type):** This records the internal temperature. Refer to page 27 "Temperature recorder".
- 16. Battery switch:** It is the switch of the battery for the power failure alarm. Turn it on usually.

INSTALLATION SITE

To operate this unit properly and to obtain maximum performance, install the unit in a location with the following conditions:

■ **A location not subjected to direct sunlight**

Do not install the unit under direct sunlight. Installation in a location subjected to direct sunlight cannot obtain the intended performance.

■ **A location with adequate ventilation**

Leave at least 10 cm around the unit for ventilation. Poor ventilation will result in a reduction of the performance and consequently the failure.

■ **A location away from heat generating sources**

Avoid installing the unit near heat-emitting appliances such as a heater or a boiler etc. Heat can decrease the intended performance of the unit.

■ **A location with little temperature change**

Install the unit under stable ambient temperature. The allowable ambient temperature is between -5 and +35°C.

■ **A location with a sturdy and level floor**

Always install the unit on a sturdy and level floor. The uneven floor or tilted installation may cause failure or injury. Install the unit in stable condition to avoid the vibration or noise. Unstable condition may cause vibration or noise.

 **WARNING**

Install the unit on a sturdy floor. If the floor is not strong enough or the installation site is not adequate, this may result in injury from the unit falling or tipping over.

Select a level and sturdy floor for installation. This precaution will prevent the unit from tipping. Improper installation may result in water spillage or injury from the unit tipping over.

■ **A location not prone to high humidity**

Install the unit in the ambient of 80% R.H. or less humidity. Installation under high humidity may cause current leakage or electric shock.

 **WARNING**

Do not use the unit outdoors. Current leakage or electric shock may result if the unit is exposed to rain water.

Never install the unit in a humid place or a place where it is likely to be splashed by water. Deterioration of the insulation may result which could cause current leakage or electric shock.

■ **A location without flammable or corrosive gas**

Never install the unit in a flammable or volatile location. This may cause explosion or fire or may result in the current leakage or electric shock by the corrosion of the electrical components.

■ **A location without the possibility of anything fall**

Avoid installing the unit in the location where anything can fall down onto the unit. This may cause the breakdown or failure of the unit.

INSTALLATION

1. Removing the packaging materials and tapes

Remove all transportation packaging materials and tapes. Open the doors and ventilate the unit. If the outside panels are dirty, clean them with a diluted neutral dishwashing detergent. (Undiluted detergent can damage the plastic components. For the dilution, refer to the instruction of the detergent.) After the cleaning with the diluted detergent, always wipe it off with a wet cloth. Then wipe off the panels with a dry cloth.

Note:

Remove the cable tie banding the power supply cord. Prolonged banding may cause the corrosion of the cord coating.

2. Adjusting the leveling foot

Extend the leveling feet by rotating them counterclockwise to contact them to the floor. Ensure the unit is level.

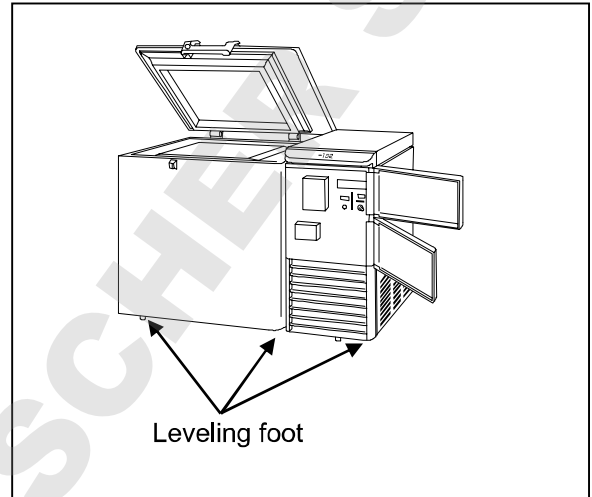

3. Fixing the unit

Two fixtures are attached to the rear of the frame. Fix the frame to the wall with these fixtures and rope or chain.

4. Ground (earth)

The ground (earth) is for preventing the electric shock in the case of the electrical insulation is somehow degraded. Always ground the unit at the time of installation.

⚠ WARNING

Use a power supply outlet with ground (earth) to prevent electric shock. If the power supply outlet is not grounded, it is necessary to install a ground by qualified engineers.

Never ground the unit through a gas pipe, water main, telephone line or lightning rod. Such grounding may cause electric shock in the case of an incomplete circuit.

START-UP OF UNIT

Follow the procedures for the initial and consequent operations of the unit.

1. Make sure that all the switches on the control panel, such as the power supply switch, battery switch, backup switch (ATN type) and remote alarm switch are off.
2. Connect the power cord to the dedicated outlet having appropriate rating with the chamber empty, and turn on the power supply switch on the freezer.
3. Turn on the battery switch.
4. The audible alarm may be activated. In this case, press the alarm buzzer stop key (BUZZER) to silence the alarm.
5. Set the desired chamber temperature. See page 14 for the chamber temperature setting.
6. Check that the chamber temperature reaches the desired temperature.
7. Turn on the backup switch (ATN type) and remote alarm switch.
8. Make sure that the alarm lamp blinks and the buzzer sounds by pressing the alarm test key (ALARM).
9. After confirming the above, you can put articles into the freezer chamber in a small batch to prevent the temperature rise.

CHAMBER TEMPERATURE SETTING

Table 1 shows the basic procedure for setting the chamber temperature. Perform key operations in the sequence indicated in the table. The example in the table is based on the assumption that the desired temperature is -145°C .

Note: The unit is set at the factory that the chamber temperature -150°C .

Table 1. Basic operation sequence (Example: Internal temperature -145°C)

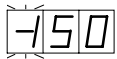
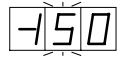
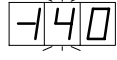
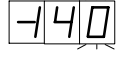
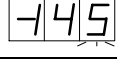
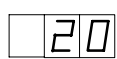
	Description of operation	Key operated	Indication after operation
1	Turn on the power switch.	----	The third digit blinks. 
2	Set the second digit with the digit shift key.	▶▶	The second digit blinks. 
2	Set the second digit to 4 with the numerical value shift key.	▲	When pressed, the figure of settable digit changes. 
3	Set the first digit with the digit shift key.	▶▶	The first digit blinks. 
4	Set the first digit to 5 with the numerical value shift key.	▲	When pressed, the figure of settable digit changes. 
5	Press enter key.	ENT	Set temperature is memorized and the current chamber temperature is displayed. 

Note:

- The temperature set mode returns to the temperature display mode automatically when 90 seconds has passed without any key operation.
- Although the value of the chamber temperature setting can range from -125°C to -155°C , the guaranteed temperature with no load is -152°C when the ambient temperature is 30°C .

REMOTE ALARM TERMINAL

The terminal of the remote alarm is installed at the back of the unit.

The signal is contact output. Contact capacity is 2 A (DC 30 V)/0.1 mA (DC 1 V).

- output: normal open, connect with N.O. and COM.
- output: normal close, connect with N.C. and COM.

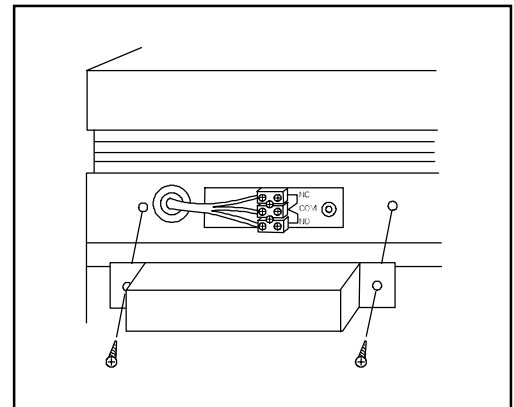

ALARM TEMPERATURE SETTING

This unit is provided with the high temperature alarm. The setting of high temperature alarm is 10°C or 15°C (The setting value is 2 kinds.) higher than the setting of chamber temperature. The procedure in table 2 shows the sequence to set the high temperature alarm at 15°C higher than the setting of chamber temperature. Set the figure to 000 at step 5 when setting the high temperature alarm at 10°C higher than the setting of the set temperature.

Note:

The alarm temperature is set at the factory 10°C higher than the setting of chamber temperature.

Table 2. High temperature alarm setting (15°C higher than the setting of chamber temperature)

	Description of operation	Key operated	Indication after operation
1		----	Set temperature is displayed.
2	Press the numerical value shift key for about 5 seconds.	▲	The first digit blinks.
3	Set the first digit to 1 with the numerical value shift key.	▲	The first digit blinks.
4	Press enter key.	ENT	The first digit blinks.
5	Set the first digit to 1 with the numerical value shift key.	▲	When pressed, the figure of settable digit changes.
6	Press enter key.	ENT	Alarm temperature is memorized and the current chamber temperature is displayed.

Note: The set mode returns to the temperature display mode automatically when 90 seconds has passed without any key operation.

SETTING OF ALARM RESUME TIME

The alarm buzzer is stopped by pressing alarm buzzer stop key (BUZZER) on the control panel during alarm condition (Initial setting 130: The remote alarm is not stopped).

The buzzer will be activated again after certain suspension if the alarm condition is continued. The suspension time can be set by following the procedure shown in the Table 3 below.

The example in the table is based on the assumption that the desired duration is 20 minutes.

Note: The duration is set to 130 at the factory.

Table 3. Setting procedure (change to 20 minutes from no alarm resume time)

	Description of operation	Key operated	Indication after operation
1		----	The current chamber temperature is displayed. -150
2	Press the numerical value shift key for about 5 seconds.	▲	The first digit blinks. F00
3	Set to F25 with the digit shift key and numerical value shift key.	▶▶	The settable digit is shifted.
		▲	When pressed, the figure of settable digit changes. F25
4	Press enter key.	ENT	The current setting is displayed and the first digit blinks. 130
5	Set to 120 with the digit shift key and numerical value shift key.	▶▶	The settable digit is shifted.
		▲	When pressed, the figure of settable digit changes. 120
6	Press enter key.	ENT	Alarm resume time is memorized and the current chamber temperature is displayed. -150

- The settable alarm resume time is between 10 and 60 minutes with 1 minute increment. (The setting is 110, 111, ----- 159, 160). The buzzer would not resume if the resume time is set in 100.
- The buzzer is ON when the resume time is changed in F25 while the resume time is counted (the buzzer is silenced by alarm buzzer stop key (BUZZER). The count of resume time is stopped.
- The setting cannot be changed during power failure.
- The set mode returns to the temperature display mode automatically when 90 seconds has passed without any key operation. In this case, any setting before pressing enter key (ENT) is not memorized.
- It is selectable whether the buzzer is in conjunction with the remote alarm or not when the buzzer is silenced by alarm buzzer stop key (BUZZER). (The remote alarm is not in conjunction with the buzzer by factory setting.)
- The remote alarm is activated in conjunction with the buzzer if the third digit "1" is set to "0" in the step 5 above

ALARMS & SAFETY FUNCTIONS

This unit has the alarm and safety functions shown in table below, and also self diagnostic function.

Table 4. Alarms and safety functions

Alarm & safety	Situation	Indication	Buzzer	Safety operation
High temperature alarm	When the chamber temp. is approx. 15°C (or 10°C) higher than the set temp.	Alarm lamp blinks.	Intermittent tone with 12 min. delay	Remote alarm with 12 min. delay
Power failure alarm	At power failure When power cord is disconnected.	Alarm lamp blinks.	Intermittent tone	Remote alarm
Filter check	When the condenser filter is clogged.	Filter check lamp blinks.	Intermittent tone	-----
Auto-return	When there is no key pressing in each setting mode for 90 seconds.	Chamber temp. is displayed.	-----	Finishing of each setting mode
Sensor abnormality	If the thermal sensor is disconnected.	Alarm lamp blinks. E01 and 50°C is displayed alternately.	Intermittent tone	Remote alarm Continuous operation
	If the thermal sensor is short-circuited.	Alarm lamp blinks. E02 and -170°C are displayed alternately.		
	If the cascade sensor is disconnected.	Alarm lamp blinks. E03 and chamber temp. are displayed alternately.	Intermittent tone	Remote alarm
	If the cascade sensor is short-circuited.	Alarm lamp blinks. E04 and chamber temp. are displayed alternately.		
	If the filter sensor is disconnected.	Alarm lamp blinks. E05 and chamber temp. are displayed alternately.	Intermittent tone	Remote alarm
	If the filter sensor is short-circuited.	Alarm lamp blinks. E06 and chamber temp. are displayed alternately.		
	If the ambient temperature sensor is disconnected.	ALARM lamp blinks. E07 and chamber temp. are displayed alternately.	Intermittent tone	Remote alarm
	If the ambient temperature sensor is short-circuited.	ALARM lamp blinks. E08 and chamber temp. are displayed alternately.		
Condenser temp. abnormality	In the event of failure of fan motor for cooling the compressor	E10 and chamber temp. are displayed alternately.	Intermittent tone	Remote alarm. Compressor of high stage side stops.

Note:

The filter check lamp sometimes blinks at the start-up under high ambient temperature. The lamp is off when the chamber temperature is getting lower.

Operation after power failure

The set value (setting of chamber temperature and alarm temperature) is memorized by nonvolatile memory. Accordingly, the freezer resumes the operation with setting before power failure.

This unit has the alarms and safety functions shown in Table 4, and also self diagnostic functions.

ROUTINE MAINTENANCE

⚠️ WARNING

Always disconnect the power supply to the unit prior to any repair or maintenance of the unit in order to prevent electric shock or injury.

Ensure you do not inhale or consume medication or aerosols from around the unit at the time of maintenance. These may be harmful to your health.

Cleaning of cabinet

- Clean the unit once a month. Regular cleaning keeps the unit looking new.
- Use a dry cloth to wipe off small amounts of dirt on the outside and inside of the unit and all accessories. If the outside panels are dirty, clean them with a diluted neutral dishwashing detergent. (Undiluted detergent can damage the plastic components. For the dilution, refer to the instruction of the detergent.) After the cleaning with the diluted detergent, always wipe it off with a wet cloth. Then wipe off the cabinet or accessories with a dry cloth.
- Never pour water onto or into the unit. Doing so can damage the electric insulation and cause failure.
- The compressor and other mechanical parts are completely sealed. This unit requires absolutely no lubrication.
- Check the backup cooling kit by pressing backup test switch once a month if it is installed.
- Remove the frost or ice on the chamber wall and clean the condenser filter once a month.

Cleaning of condenser filter

This unit is provided with the filter check lamp. This lamp blinks and the alarm buzzer sounds when the condenser filter is clogged. Clean the condenser filter according to the following procedure. As a clogged condenser filter may cause poor cooling and compressor trouble, clean it once a month.

1. The condenser filter fitted to the grille can be removed as shown in the figure.
2. Pull out the grille.
3. Remove the condenser filter installed inside the grille and wash with water and dry it naturally.
4. Replace the clean condenser filter as before.
5. Replace the grille.

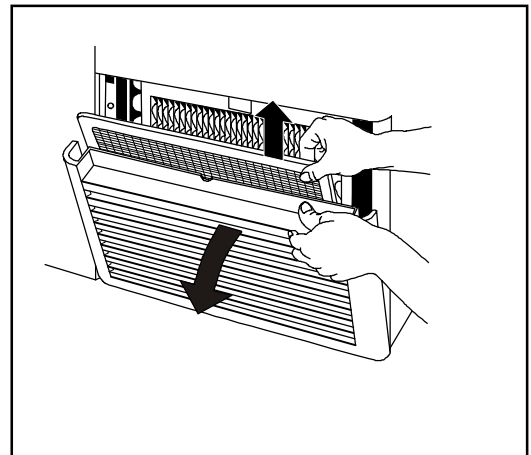

⚠️ WARNING

Do not touch the condenser directly when the condenser filter is removed for cleaning. This may cause injury by hot surface.

ROUTINE MAINTENANCE

Defrosting of inside wall

Defrost the inside wall of the freezer as follows:

Normal defrosting

Remove the frost by the enclosed scraper.

Thorough defrosting

1. Take out and transfer all the contents to another freezer or container which contains liquid CO₂, liquid N₂, or dry ice. Switch off the remote alarm, battery switch and backup cooling kit. Switch off the power supply switch.
2. Open the door and remove the inner lid. Leave the freezer as it is. The water remaining in the freezer compartment should be wiped up.
3. After cleaning is completed, restart the operation according to the procedure on page 13. Put back the articles into the sufficiently cooled freezer compartment.

TROUBLESHOOTING

If the unit malfunctions, check out the following before calling for service.

Malfunction	Check/Remedy
If nothing operates even when switched on	<ul style="list-style-type: none"> ▪ The unit is not connected to the power supply. ▪ There is a power failure. ▪ The fuse is blown or the circuit breaker is activated.
No refrigeration	<ul style="list-style-type: none"> ▪ The voltage too low. (In this case, call an electrician.) ▪ The breaker free.
The cooling is poor	<ul style="list-style-type: none"> ▪ The environmental temperature is too high. ▪ The door is not shut tightly. ▪ The inner lid is not installed correctly. ▪ The set temperature is not set properly. ▪ The grille is blocked out. ▪ The condenser filter is clogged. ▪ The freezer is in the direct sunlight. ▪ There is any heating source near the freezer. ▪ A rubber cap and insulation for the access port are not set correctly. ▪ You put too many unfrozen articles into the freezer compartment.
Alarm test key cannot actuate the alarm	<ul style="list-style-type: none"> ▪ The battery has been discharged entirely. In this case, operate the freezer for about 3 hours and switch on the alarm test key again. Entirely discharged cell requires about 2 days' operation. ▪ When only the buzzer or only the alarm is actuated by the alarm test key, the unactuated part is out of order, and must be replaced.
Recorder for ATN type does not operate normally	<ul style="list-style-type: none"> ▪ If the chart was not fed, examine the dry cell. The cell for the recorder lasts about 1 year. ▪ If the temperature was not recorded, examine the ink pen. The pen should be our specified one. Is the recorder chart set correctly?
Noise	<ul style="list-style-type: none"> ▪ The freezer is not stable. ▪ The freezer is not leveled with the leveling feet. ▪ There is anything touching the frame. ▪ It is the first operation after shutdown. ▪ High temperature loads this freezer, and sometimes causes a noise. Accordingly when the temperature lowered, the noise ceases.
Backup test switch does not operate normally (when the backup cooling kit is provided)	<ul style="list-style-type: none"> ▪ The liquid N₂ tank is not filled up. ▪ The valve of the tank is not opened. ▪ The pressure of liquid N₂ is 0.5 kg/cm²G. Inquire at liquid N₂ suppliers about its installation, removal, adjustment, and examination.

Note:

If the malfunction is not eliminated after checking the above items, or the malfunction is not shown in the above table, contact our sales representative or agent.

DISPOSAL OF UNIT

WARNING

If the unit is to be stored unused in an unsupervised area for an extended period **ensure that children do not have access and doors cannot be closed completely.**

The disposal of the unit should be accomplished by appropriate personnel. Always remove doors to prevent accidents such as suffocation.

Recycle of battery



The unit contains a rechargeable battery. The battery is recyclable. At the end of its useful life, check with your local solid waste officials for options or proper disposal.



* Label indication is obliged to comply with Taiwanese battery regulation.

Decontamination of unit

Before disposing a ultra low temperature freezer with biohazardous danger, decontaminate the ultra low temperature freezer to the extent possible by the user.

DISPOSAL OF UNIT

Note:

This symbol mark and recycle system are applied only to EU countries and not applied to the countries in the other area of the world.

Waste Electrical and Electronic Equipment (WEEE) Directive-2002/96/EC

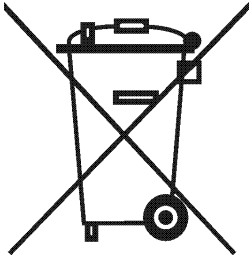

(English)

Your Panasonic product is designed and manufactured with high quality materials and components which can be recycled and reused.

This symbol means that electrical and electronic equipment, at their end-of-life, should be disposed of separately from your household waste.

Please dispose of this equipment at your local community waste collection/recycling centre.

In the European Union there are separate collection systems for used electrical and electronic products.

Please help us to conserve the environment we live in!

(German)

Ihr Panasonic Produkt wurde entworfen und hergestellt mit qualitativ hochwertigen Materialien und Komponenten, die recycelt und wiederverwendet werden können.

Dieses Symbol bedeutet, daß elektrische und elektronische Geräte am Ende ihrer Nutzungsdauer von Hausmüll getrennt entsorgt werden sollen.

Bitte entsorgen Sie dieses Gerät bei Ihrer örtlichen kommunalen Sammelstelle oder im Recycling Centre.

In der Europäischen Union gibt es unterschiedliche Sammelsysteme für Elektrik- und Elektronikgeräte.

Helfen Sie uns bitte, die Umwelt zu erhalten, in der wir leben!

DISPOSAL OF UNIT

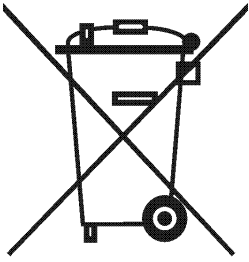

(French)

Votre produit Panasonic est conçu et fabriqué avec des matériaux et des composants de qualité supérieure qui peuvent être recyclés et réutilisés.

Ce symbole signifie que les équipements électriques et électroniques en fin de vie doivent être éliminés séparément des ordures ménagères.

Nous vous prions donc de confier cet équipement à votre centre local de collecte/recyclage. Dans l'Union Européenne, il existe des systèmes sélectifs de collecte pour les produits électriques et électroniques usagés.

Aidez-nous à conserver l'environnement dans lequel nous vivons !

Les machines ou appareils électriques et électroniques contiennent fréquemment des matières qui, si elles sont traitées ou éliminées de manière inappropriée, peuvent s'avérer potentiellement dangereuses pour la santé humaine et pour l'environnement.

Cependant, ces matières sont nécessaires au bon fonctionnement de votre appareil ou de votre machine. Pour cette raison, il vous est demandé de ne pas vous débarrasser de votre appareil ou machine usagé avec vos ordures ménagères.

(Spanish)

Los productos Panasonic están diseñados y fabricados con materiales y componentes de alta calidad, que pueden ser reciclados y reutilizados.

Este símbolo significa que el equipo eléctrico y electrónico, al final de su ciclo de vida, no se debe desechar con el resto de residuos domésticos.

Por favor, deposite su viejo equipo en el punto de recogida de residuos o contacte con su administración local.

En la Unión Europea existen sistemas de recogida específicos para residuos de aparatos eléctricos y electrónicos.

Por favor, ayúdenos a conservar el medio ambiente!

DISPOSAL OF UNIT

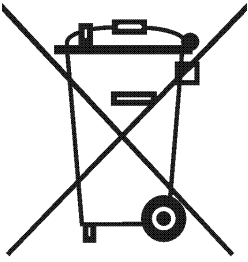

(Portuguese)

O seu produto Panasonic foi concebido e produzido com materiais e componentes de alta qualidade que podem ser reciclados e reutilizados.

Este símbolo significa que o equipamento eléctrico e electrónico no final da sua vida útil deverá ser descartado separadamente do seu lixo doméstico.

Por favor, entregue este equipamento no seu ponto local de recolha/reciclagem.

Na União Europeia existem sistemas de recolha separados para produtos eléctricos e electrónicos usados.

Por favor, ajude-nos a conservar o ambiente em que vivemos!

(Italian)

Il vostro prodotto Panasonic è stato costruito da materiali e componenti di alta qualità, che sono riutilizzabili o riciclabili.

Prodotti elettrici ed elettronici portando questo simbolo alla fine dell'uso devono essere smaltiti separatamente dai rifiuti casalinghi.

Vi preghiamo di smaltire questo apparecchio al deposito comunale.

Nell'Unione Europea esistono sistemi di raccolta differenziata per prodotti elettrici ed elettronici.

Aiutateci a conservare l'ambiente in cui viviamo!

DISPOSAL OF UNIT

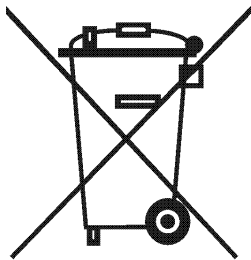

(Dutch)

Panasonic producten zijn ontwikkeld en gefabriceerd uit eerste kwaliteit materialen, de onderdelen kunnen worden gerecycled en weer worden gebruikt.

Het symbool betekent dat de elektrische en elektronische onderdelen wanneer deze vernietigd gaan worden, dit separaat gebeurt van het normale huisafval.

Zorg ervoor dat het verwijderen van de apparatuur bij de lokaal erkende instanties gaat gebeuren. In de Europese Unie wordt de gebruikte elektrische en elektronische apparatuur bij de daarvoor wettelijke instanties aangeboden.

Alstublieft help allen mee om het milieu te beschermen.

(Swedish)

Din Panasonic produkt är designad och tillverkad av material och komponenter med hög kvalitet som kan återvinnas och återanvändas.

Denna symbol betyder att elektriska och elektroniska produkter, efter slutanvändande, skall sorteras och lämnas separat från Ditt hushållsavfall.

Vänligen, lämna denna produkt hos Din lokala mottagningstation för avfall/återvinningsstation.

Inom den Europeiska Unionen finns det separata återvinningssystem för begagnade elektriska och elektroniska produkter.

Vänligen, hjälp oss att bevara miljön vi lever i!

DISPOSAL OF BATTERY

Location of a nickel-metal-hydride battery

This unit is provided a nickel-metal hydride battery for the power failure alarm. The battery is located in the control box inside the LED cover. (Fig. 1)



The high voltage components are enclosed in the control box. The cover should be removed by a qualified engineer or a service personnel only to prevent the electric shock.

Disposal of nickel-metal-hydride battery

1. Turn off the power supply switch and disconnect the power supply plug.
2. As shown in the Fig. 1, remove 2 fixing screw A at the front lower of the LED cover with a screw driver.
3. Remove 2 screw B at the back of the foamed side table assy. (Fig. 2)
4. After disconnecting the connector, remove the LED cover. Then by unscrewing 2 screw C on the top of the foamed side table assy, remove the foamed side table assy. To remove the control box cover, unscrew 4 fixing screw D. (Fig. 3)
5. Remove 2 screw E fixing the battery mounting plate securing the battery and then disconnect the connector. (Fig. 4)
6. Take out the battery.

Handling of battery

Cover the battery terminal with an insulating tape to avoid the short circuit. Then follow the procedure for recycling or proper disposal.

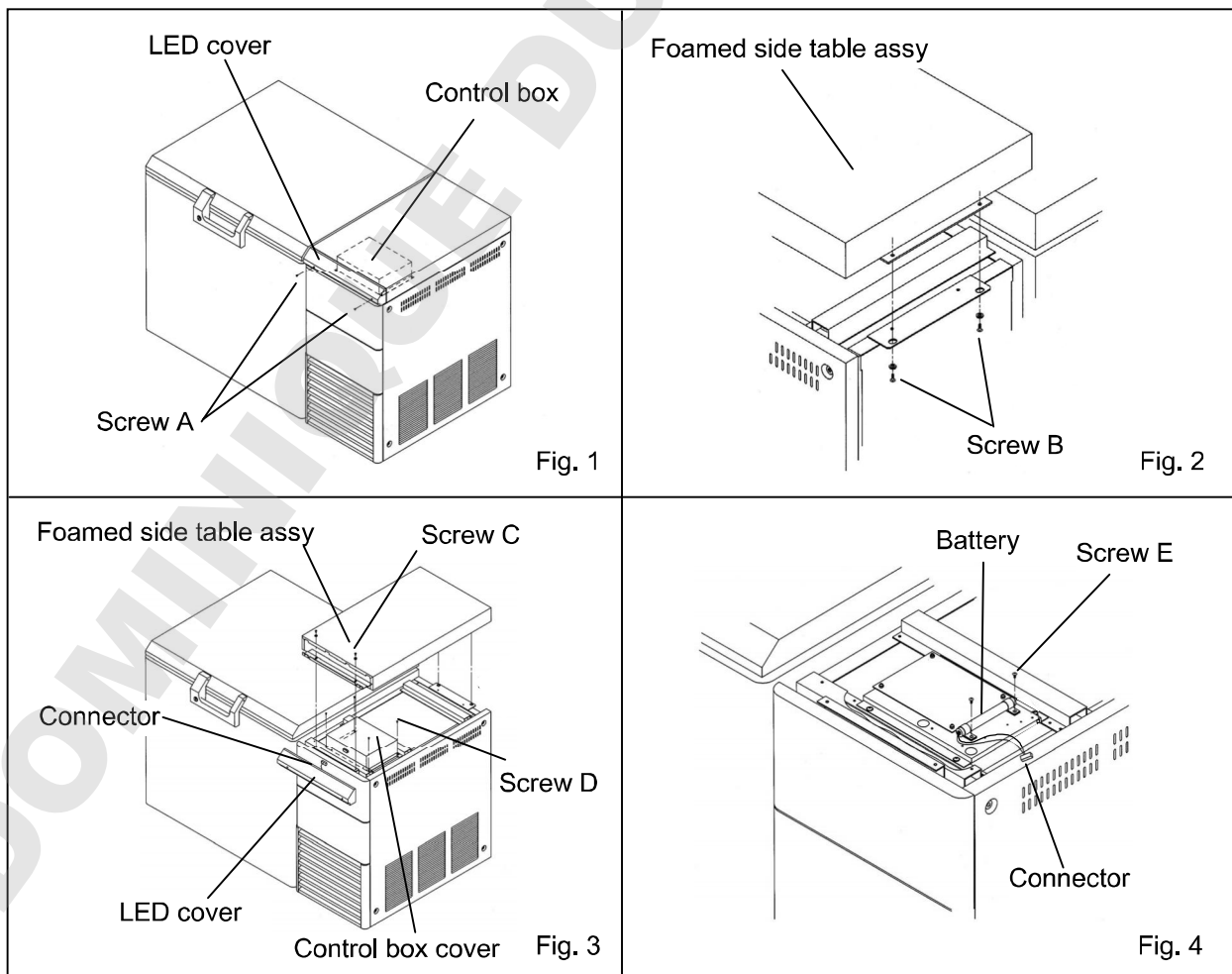

TEMPERATURE RECORDER



WARNING

Disconnect the power supply plug before attaching the temperature recorder or it may cause electric shock or fire.

The figure below shows the description of a temperature recorder.

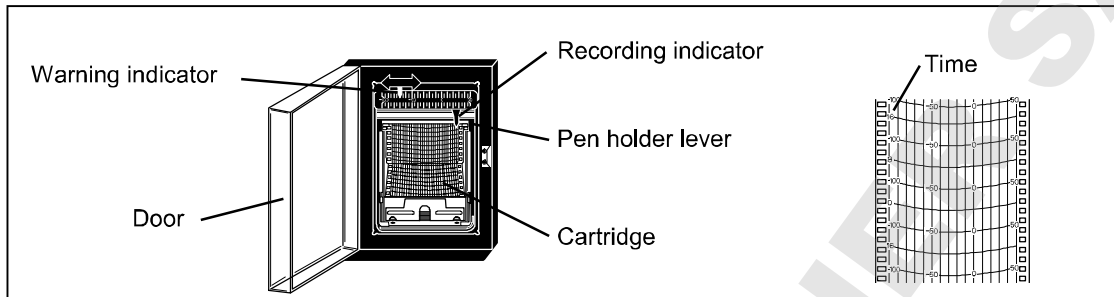

Feeding of chart

1. Open the door and let down the pen holder lever; the pen point is apart from the chart. (Fig. 1)
2. Pull the cartridge out of the mounted position. (Fig. 2)
3. Set a new chart in place on the rear bottom of the cartridge. Set the hole on the chart in the cog of the chart driving assembly and feed the chart in the direction of the arrow by driving the cog wheel.
4. Set the chart according to the mark of day and time. (Fig. 3)
5. When mounting, lay down the cartridge first, and push into the mounting position with the groove set a the projection on the position.
6. Set up the cartridge and settle in position.
7. Lift up the pen holder lever and close the door.

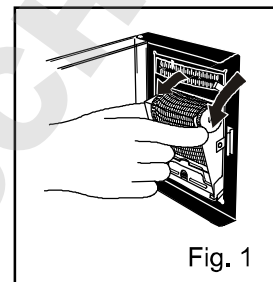

Fig. 1

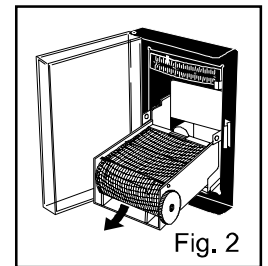

Fig. 2

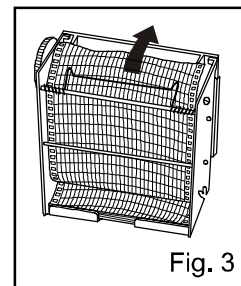
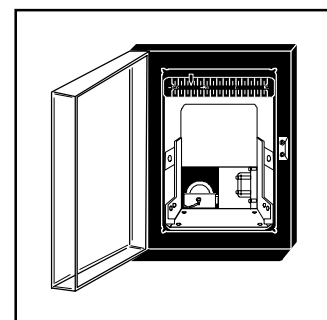

Fig. 3

Replacement of cell

Replace the dry cell once a year as follows:

1. Put down the pen holder lever first, then pull out cartridge from the mounted position.
2. Reset the battery box cover with wire, on the bottom left side, and take out the cell.
3. Set a new cell in the case.
4. Shut the battery box cover after exchanging cells. Mount the cartridge as before and lay up the penholder lever.



Setting of backup temperature

1. There is a warning indicator (red guide) on the top of the recording indicator. Adjust the warning indicator with your finger to backup temperature, at which temperature the backup cooling kit starts to operate.
2. Set at a temperature 15°C higher than that in the freezer chamber.

TEMPERATURE RECORDER

Pen holder

Install a ink pen in the recording hand as shown in the figure. Make sure that the ink pen is completely inserted for accurate recording. The ink pen is packed together with the chart.

1. Let down the penholder lever, then pull out the cartridge from the mounted position.
2. Insert a new pen.
3. Mount the cartridge into place.
4. Lift up the penholder lever and make sure that the pen point touches the chart.

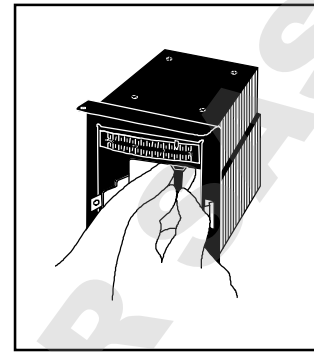

BACKUP COOLING KIT

Backup cooling kit for MDF-1156ATN (Liquid N₂ type)

1. Connect the liquid N₂ tank with the backup cooling kit joint by using connect tube and the joint attached with this freezer. This work should be done by high pressure gas works specialists. The pressure of liquid N₂ tank should be regulated at 0.5 kg/cm²G.
2. Operate the freezer until the freezer temperature reaches the required level.
3. Set the warning indicator of the temperature recorder at 15°C higher than the freezer temperature.
4. Switch on the liquid N₂ backup. This completes the backup cooling kit setting.
5. Make sure that liquid N₂ spouts into the freezer chamber with the backup test switch.
6. This completes the setting of the tank for automatic spouting in case the freezer temperature should match the alarm set temperature.

SPECIFICATIONS

Product name	Ultra-Low Temperature Freezer MDF-1156	Ultra-Low Temperature Freezer MDF-1156ATN
External dimensions	W1400 mm x D800 mm x H945 mm	
Internal dimensions	W500 mm x D450 mm x H572 mm	
Effective capacity	128 L	
Exterior	Painted steel	
Interior	Aluminum plate	
Door	Painted steel	
Insulation	Rigid polyurethane foamed-in place	
Compressor	Hermetic type, 1100 W x 2	
Condenser	Fin and tube type (high stage side), Shell and tube type (low stage side)	
Evaporator	Tube on sheet type	
Refrigerant	R-407D (high stage side), HFC mixed refrigerant (low stage side)	
Temperature controller	Microprocessor control system	
Temperature display	Digital display	
Sensor	Platinum resistance (Pt 100 Ω)	
Alarm	buzzer, lamp, remote alarm contact	
Battery	For power failure alarm; Nickel-metal-hydride battery, DC 6 V, 650 mAh, (5HR-4UC) Auto-recharge For backup cooling kit; Lead storage battery, DC 6 V, 4 Ah	
Temperature recorder	----	Dry cell driven Recording chart (for 2 months)
Backup cooling kit	----	Liquid N ₂
Accessories	1 set of key, 2 rubber caps, 1 inner lid, 1 scraper	
	----	6 recording paper, 1 dry cell 2 ink pens (cartridge) 1 connect tube for backup cooling kit
Weight	265 kg	272 kg
Option	Storage case (MDF-49SC)	

Note: Design or specifications will be subject to change without notice.

The battery for power failure alarm is an article for consumption. It is recommended that the battery will be replaced about every 3 years. Contact our sales representative or agent at the time of replacement of the battery for recycling.

Refer to the updated catalog when ordering an optional component.

PERFORMANCE

Product name	Ultra-Low Temperature Freezer MDF-1156/MDF-1156ATN		
Model number.	MDF-1156-PB MDF-1156ATN-PB	MDF-1156-PK MDF-1156ATN-PA MDF-1156ATN-PK	MDF-1156-PE MDF-1156ATN-PE
Cooling performance	-152°C at the center of the chamber; (Ambient temperature; +30°C, no load)		
Control range	-130°C to -152°C		
Power voltage	AC 220 V	AC 220 V	AC 230 V/240 V
Rated frequency	50 Hz	60 Hz	50 Hz
Rated power consumption	1550 W	1700 W	1550 W/1600 W
Alarm duration	9 hours		
Noise level	52 dB/54 dB (50 Hz/60 Hz) [A] (background noise; 20 dB)		
Maximum pressure	2844 kPa		

Note: The unit with CE mark complies with EC directives.

⚠ CAUTION

**Please fill in this form before servicing.
Hand over this form to the service engineer to keep for his and your safety.**

Safety check sheet

- 1. Freezer contents : Yes No
- Risk of infection: Yes No
- Risk of toxicity: Yes No
- Risk from radioactive sources: Yes No

(List all potentially hazardous materials that have been stored in this unit.)

Notes :

2. Contamination of the unit:

- Unit interior: Yes No
- No contamination: Yes No
- Decontaminated: Yes No
- Contaminated: Yes No

Others:

3. Instructions for safe repair/maintenance of the unit

- a) The unit is safe to work on Yes No
- b) There is some danger (see below) Yes No

Procedure to be adhered to in order to reduce safety risk indicated in b) below.

Date :

Signature :

Address, Division :

Telephone :

Product name: Ultra-low temperature freezer	Model: MDF-	Serial number:	Date of installation:
---	----------------	----------------	-----------------------

Please decontaminate the unit yourself before calling the service engineer.

DOMINIQUE DUTSCHER SAS

Panasonic Healthcare Co., Ltd.

1-1-1 Sakata, Oizumi-Machi, Ora-Gun, Gunma 370-0596 Japan

© Panasonic Healthcare Co., Ltd. 2012

Printed in Japan
7FB6P151429001
S0412-10412