

Quick Start Guide Adventurer™ Balances

ASSEMBLY

1) Unpack the balance

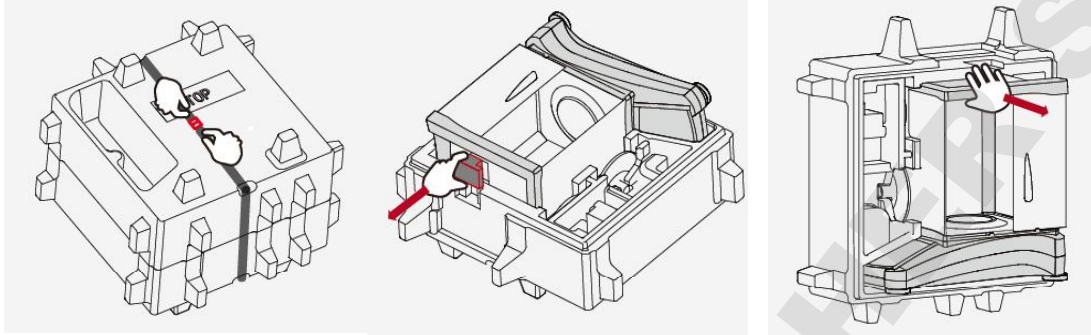

1) Remove the binder

2) Take out the red cube

3) Take out the balance

For 1mg and 0.1mg Models:



2) Install Wing ring and weighing pan

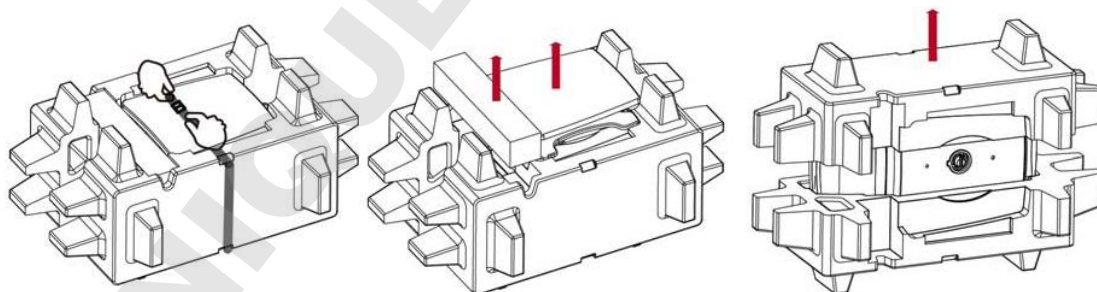

1) Remove the binder

2) Take out the adaptor box and weighing pan

3) Take out the balance

For 0.1g and 0.01g Models:

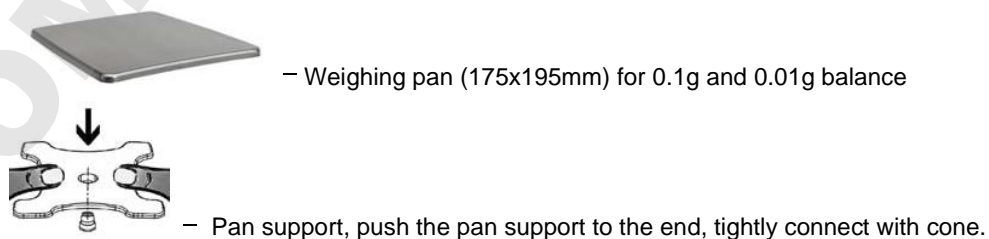

SAFETY PRECAUTIONS







CAUTION: Read all safety warnings before installing, making connections, or servicing this equipment. Failure to comply with these warnings could result in personal injury and/or property damage. Retain all instructions for future reference.

- Verify that the AC adapter's input voltage range and plug type are compatible with the local AC power to be used.
- Make sure that the power cord does not pose a potential obstacle or tripping hazard.
- The balance is for indoor use only.
- Use the balance only in dry locations.
- Do not drop loads on the pan.
- Use only approved accessories and peripherals.
- Operate the equipment only under ambient conditions specified in these instructions.
- Disconnect the equipment from the power supply when cleaning.
- Do not operate the equipment in hazardous or unstable environments.
- Service should only be performed by authorized personnel.
- Do not position the balance such that it is difficult to reach the power connection.

CONTROLS



Button	Action
	Short Press (if powered Off): Turns on the scale Long Press (if powered On): Turns off the scale Note: The balance will automatically power on when power is connected.
	Short Press: Prints the present data to a printer or a computer.
	Short Press: Perform Zero operation
	Short Press: Perform Calibration operation
	Short Press: Perform Tare operation

Quick Start Guide Adventurer™ Balances

Main Application Screen

Application	Dynamic Weighing	Max 4201 g d= 0.01 g e= 0.01 g	Capacity and readability	
Instructional Messages	Place sample on the pan. Press Start to begin averaging.		Result Field: Information varies by application	
Stability (*), Net (NET), Gross (G) and/or center of zero (>0<) indicators	* >0<	0.00 g	Touch g to change unit	
Reference Fields	Gross: 0.00 g Net: 0.00 g	Averaging Time: 5 s Automatic Mode: Off	Application Buttons: Functions vary by	
	Item Settings	Start	Save to USB	Menu

MENU & SCREEN NAVIGATION

Touch **Menu** to open the menu list.



Calibration:

Touch to view calibration options.



Balance Setup:

Touch to view and change balance settings.



Weighing Units:

Touch to view and change weighing units.



Data Maintenance:

Touch to view data maintenance settings.



GLP and GMP Data:

Insert user data for traceability.



Communication:

Touch to view COM Device Settings and Print Settings.



Factory Reset:

Touch to do a Factory reset of menu settings.



Lockout:

Touch to view lockout options.

Adventurer™ Balances Quick Start Guide

APPLICATIONS

The balance can be configured to operate in various Application modes. Touch the top left Application field (weighing in the example below):



The Adventurer Balance has 9 application modes, as follows:

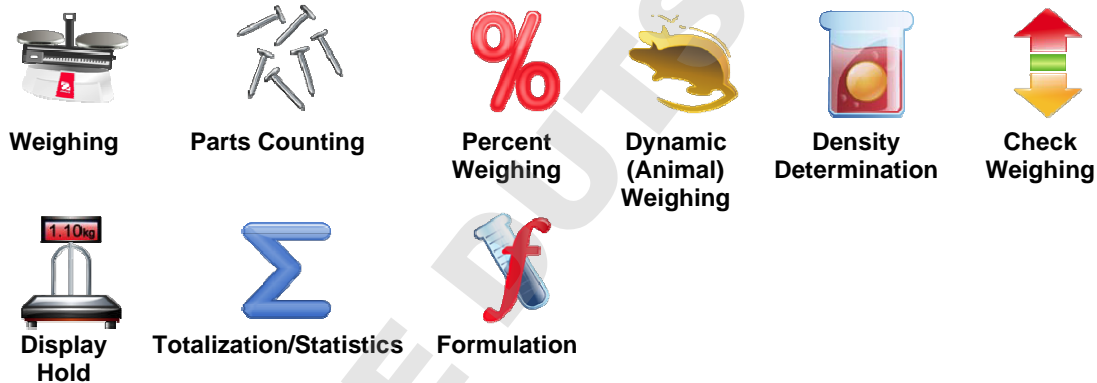

Connecting the Interface

Use the built-in RS-232 Port to connect either to a computer or a printer with a standard (straight-through) serial cable. Or connect using the scale's USB port.

Interface connections on the rear of the balance:



USB1

RS232

USB1: Used to connect to PC only
RS232: Used to connect to PC or Printer

USB connection on the front of the balance:



USB2

USB2: Used to connect a USB flash driver only

Weigh Below Hook

To use this feature, remove power from the balance, then remove the protective cover for the weigh below opening.



Weigh below protective cover

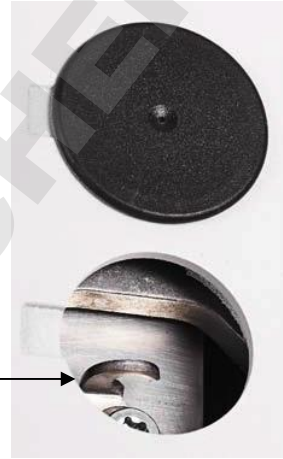

Weigh below hook

Adventurer™ Balances Quick Start Guide



Ohaus Corporation
7 Campus Drive
Suite 310
Parsippany, NJ 07054 USA
Tel: (973) 377-9000
Fax: (973) 944-7177

With offices worldwide.
www.ohaus.com



* 3 0 1 1 1 7 6 0 *

P/N 30111760A © 2014 Ohaus Corporation, all rights reserved.