

**Mupid-One<sup>®</sup>**  
Electrophoresis System

**Instruction Manual**

DOMINIQUE DUTSCHER SAS

## Before Use



*Mupid-One* is a device for electrophoresis in laboratory use.

Do not use this product for any other purpose.

Please read this manual carefully before you start to operate the *Mupid-ACE*.

## Safety Precautions:

Explanation of symbols used in this manual and product.

	This symbol denotes a general caution or warning. Be sure to follow the instruction.
	This symbol denotes the hazardous to health. Be sure to follow the instruction.
	This symbol denotes the danger of electrical shock. Caution high voltage and be sure to follow the instruction.

## WARNING

- DANGER-HIGH VOLTAGE - Although the *Mupid-One* is equipped with a safety system, the apparatus should always be operated with extreme caution.
- Do not disassemble and/or deform *Mupid-One* and its any parts. Such a change may cause electric shock, fire or disorder of the device.
- Do not touch the Power Supply with wet hands during operation. Do not insert fingers or any other objects into the Electrophoresis Cell during electrophoresis.
- When you find breakdown and/or crack of the outer surface of Power Supply, then unplug it and contact the sales dealer.
- Immediately unplug the Power Supply, if the system is smoking, noising and/or abnormally smelling. If not followed, it could lead to fire or electric shock.
- Do not touch the Electrodes and their Electrode Connector during electrophoresis.
- Do not attempt to use any other Lids with this system. The Lid supplied with the Electrophoresis Cell is the only authorized type of Lid to be used.
- Always disconnect the Power Supply from the main power source before disconnecting it from the Electrophoresis Cell.
- In case of observing with UV transilluminator, always wear face-shield and gloves.
- Many of the reagents used in the electrophoretic process are hazardous(i.e. ethidium bromide,acrylamide,boric acid,etc.). Extreme care should be taken when handling these reagents.
- Unplug the Power Supply from the main power source when not in use.
- When unplugging the Power Supply, turn off the Main Switch of it at first.
- Do not put anything in front of the wall outlet so as to disconnect the plug at once in abnormal condition.

- The *Mupid-One* Power Supply is designed to work with an input 100VAC-240VAC. Be sure to use the appropriate power cable for local voltage requirements.
- Using the Electrophoresis Cell with the unauthorized Power Supply will disable the safety feature and present a risk of electric shock. ADVANCE Co.,Ltd is not responsible for any injury or damage caused by inappropriate use of any components of this system.
- Be sure to leave sufficient space around the Power Supply to allow for free air circulation. The vents on the side of the Power Supply are designed for cooling of internal parts and should not be blocked. Prevent liquid from entering the Power Supply.
- Detach the Power Supply from the Electrophoresis Cell before lifting it. Unplug the Power Supply and empty the Electrophoresis Cell before moving it to another location.
- If liquid is accidentally spilled over the Power Supply, disconnect the device from the main power source immediately and wipe with paper towels. If there is a chance that the liquid entered the Power Supply let it dry for several hours in a dry, well ventilated environment (such as chemical hood) before using it again.
- Change of temperature or relative humidity (such as change of place from cold room to other room at higher temperature) may form the dew inside the Power Supply. Wait for a while for drying the dew on such an occasion. Do not use the device with wet hands or wet gloves.If not followed, it could lead to electric shock.
- *Mupid-One* shall be used on the level and stable table. In case unit is inclined more than 10 degrees, the buffer liquid in the Cell may spill and/or the precise migration may not be possible.
- **Keep the Safety Lid on the Cell during electrophoresis.**
- To disassemble the Cell from the Power Supply, remove gently the Lid as shown in the illustration by using the handle of the Lid as a fulcrum to turn off the Power Supply.

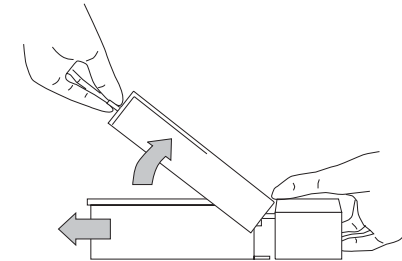

## Contents

The following contents are included in this product.

Electrophoresis Units		Gel-Casting Set (HR: heat resistant)	
Electrophoresis Cell	1	Gel Tray S -HR	2
Safety Lid	1	Gel Tray L -HR	1
Power Supply	1	Comb -HR	4
		Gel-Casting Stand -HR	1
Instruction Manual	1	Center Partition -HR	1

Be sure to use the appropriate power cable for local voltage requirements and the safety standard.

# 1. Mupid-One® Construction and Functions

## 1-1 Electrophoresis Units

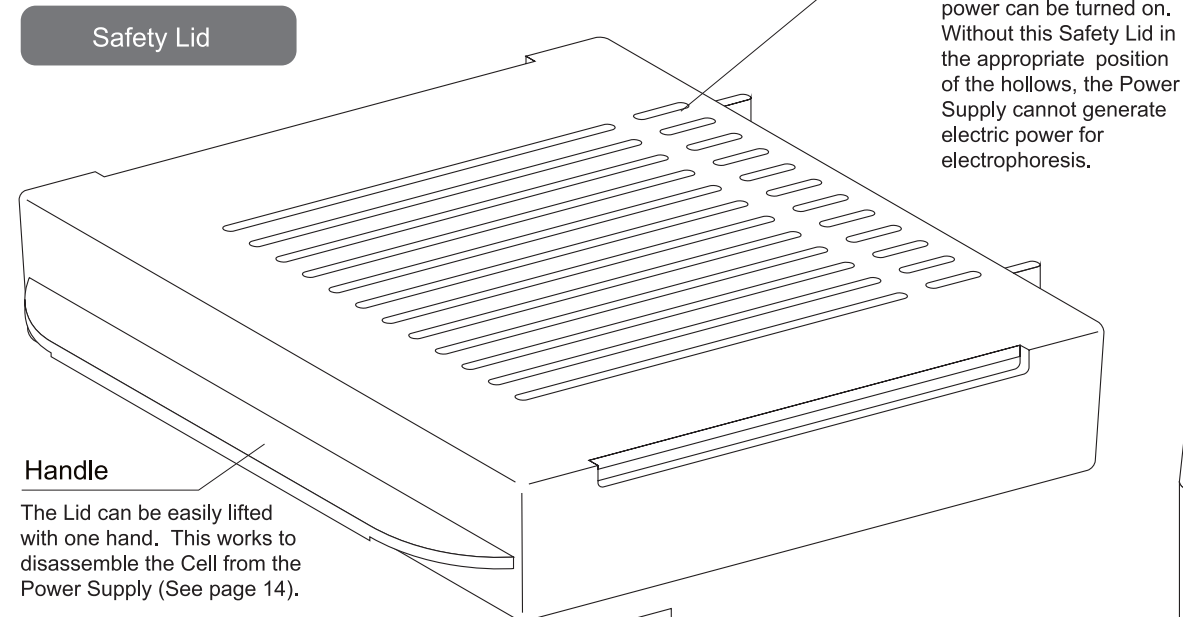

### Safety bars

When these twin bars fit the slits of the Power Supply well, the electrical power can be turned on. Without this Safety Lid in the appropriate position of the hollows, the Power Supply cannot generate electric power for electrophoresis.

### Electrophoresis Cell

The Electrophoresis Cell is made of fire-resistant plastics.

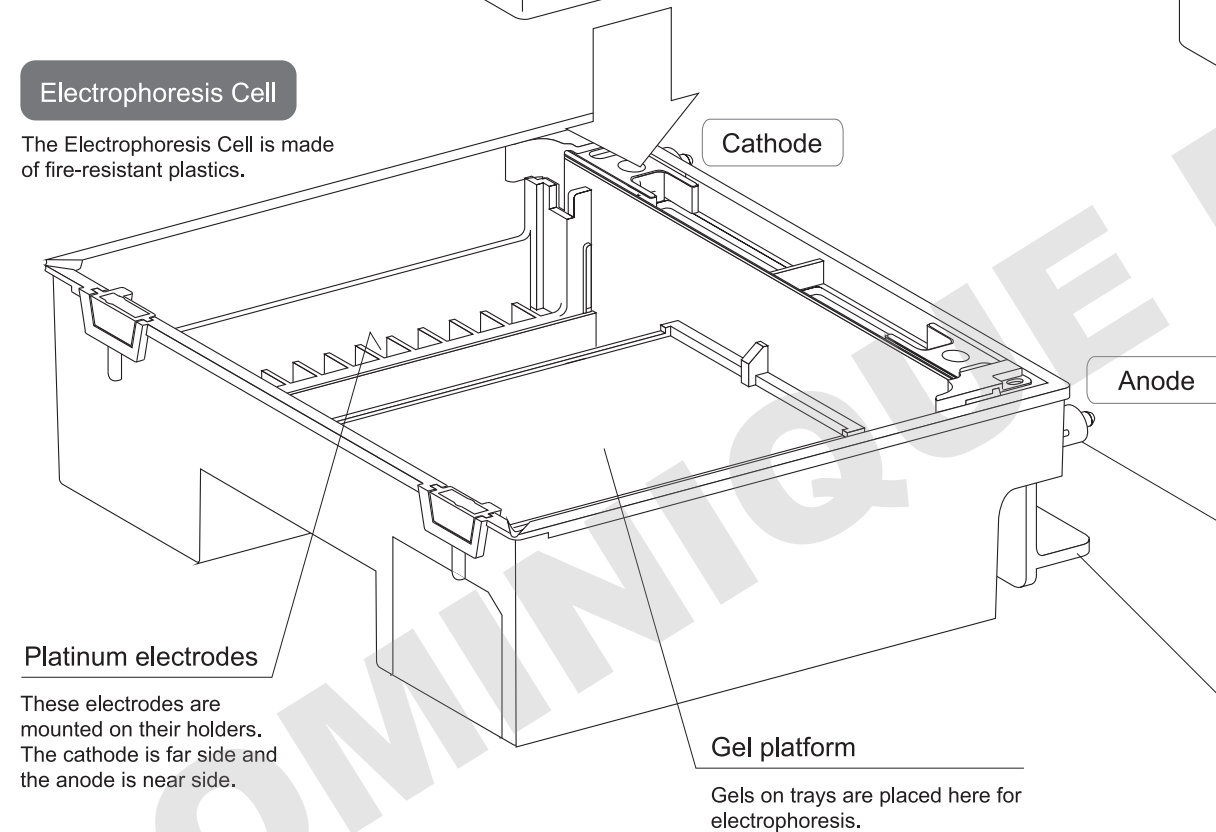

### Platinum electrodes

These electrodes are mounted on their holders. The cathode is far side and the anode is near side.

### Gel platform

Gels on trays are placed here for electrophoresis.

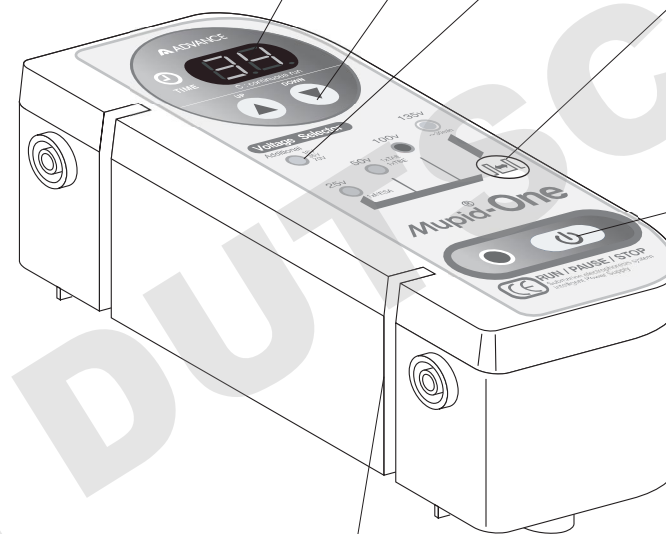

### Timer Display

Displays the preset time, remaining operating time or continuous run mode. And letters are displayed under abnormal condition.

### Down and Up Buttons

Allow setting the required run time within a range of 1 to 99 minutes. Set zero for continuous run mode ("c" will be displayed on the Timer Display.) These are also used for setting additional voltages (See page 13).

### ADDITIONAL display LED

Turns red when one of the additional voltages (18V, 35V, 70V) is selected. Push the voltage selector when the red LED flashes and you will then see the selected voltage on the timer display.

### Voltage selector

Pressed to select 25V, 50V, 100V, 135V or ADDITIONAL output. For additional output voltage information, please see page 13.

### Run/Pause/Stop Button

Use this button to turn voltage on, off and to pause. The LED on the left side of the button remains lit when system power is on.

### Power Supply

**Mupid-One** upgraded power supply features seven voltage settings, timer, last voltage memory, over current protection, and safety interlock system.

### Main Switch

Turning this switch OFF results in completely turning off the Power Supply. Turn this switch OFF first, before plugging and unplugging.

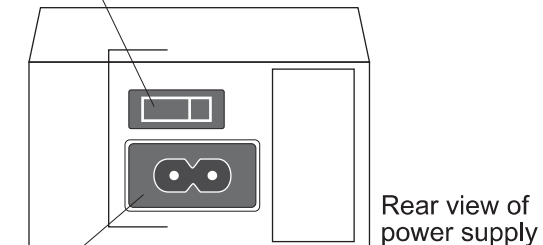

### Electrical Power Input Plug

Accepts wide range power input from AC100V to AC240V. Ensure an approved power cable that satisfies your regional safety standards is used. **Disconnect the power cable from this plug in abnormal condition.**

### Safety switch slits

Safety switches are turned on with Safety bars. If the Lid is absent, electrical power cannot be turned on for safety.

### Electrode connector

Connects the electrodes to the Power Supply. This connector is gold-plated and can be cleaned in its entirety with for example, distilled water. After washing thoroughly dry.

### Power Supply holder

Supports part of the weight of the Power Supply.

## 1-2 Gel Casting Set

Made of high temperature resistant plastic, all *Mupid*- Gel Trays, Combs and Gel Casting Stand allow to use in hot water up to 100 °C (212 F).

### Gel Tray L -HR

Large gels are made with this Tray. Maximum separation length for practical usage is about 105mm with this Tray. The width of this Tray suits the usage of a multi-pipette.

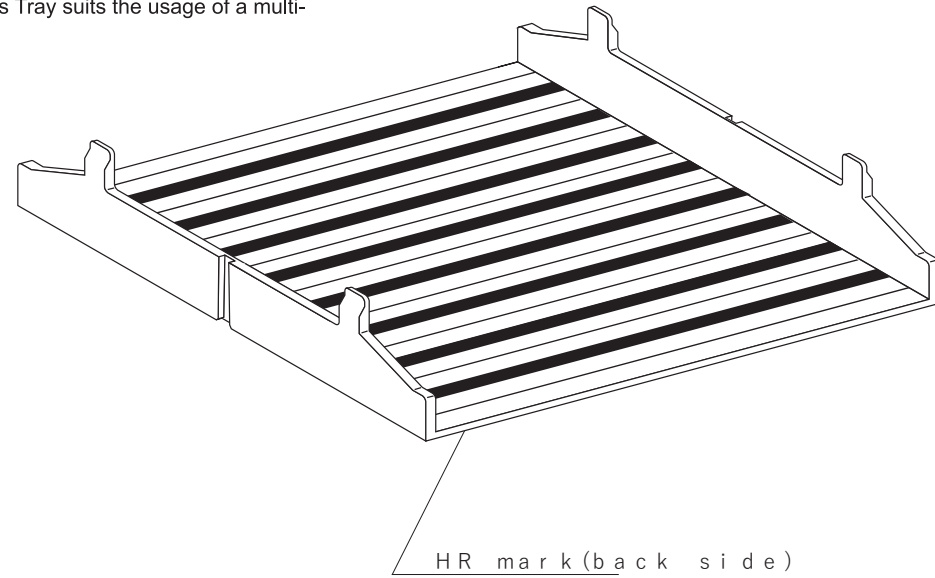

### Gel Tray S -HR

Small gels are made using this Tray. Maximum separation length for practical usage is about 55mm with this Tray. The width of this Tray suits the usage of a multi-channel pipette.

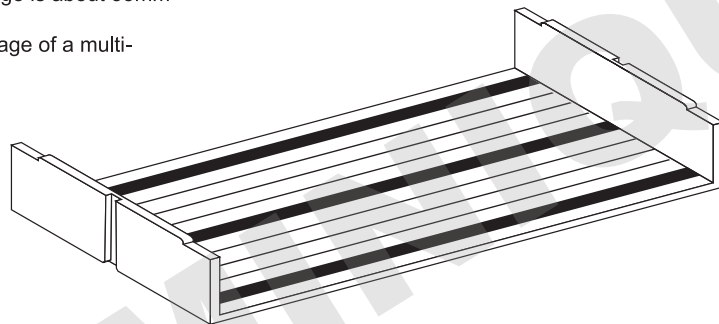

### Combs -HR

Set these Combs in the Gel Casting Stand to form wells. Double-sided Combs are provided: 13 teeth (6mm wide wells), and 26 teeth (2mm wide wells). The spacing of these wells is compatible with a multi-channel pipette.

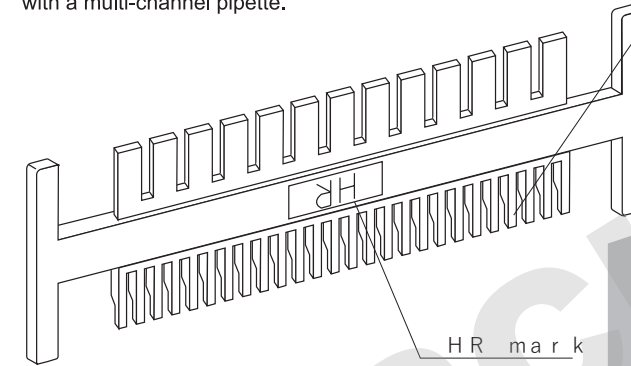

### Shape

The 26-toothed Comb is designed for excellent band resolution.

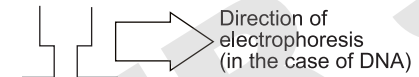

With the 26-toothed Comb, electrophoresis is the direction as shown in this figure.

### Center Partition -HR

When using the large Gel Tray, remove this center.

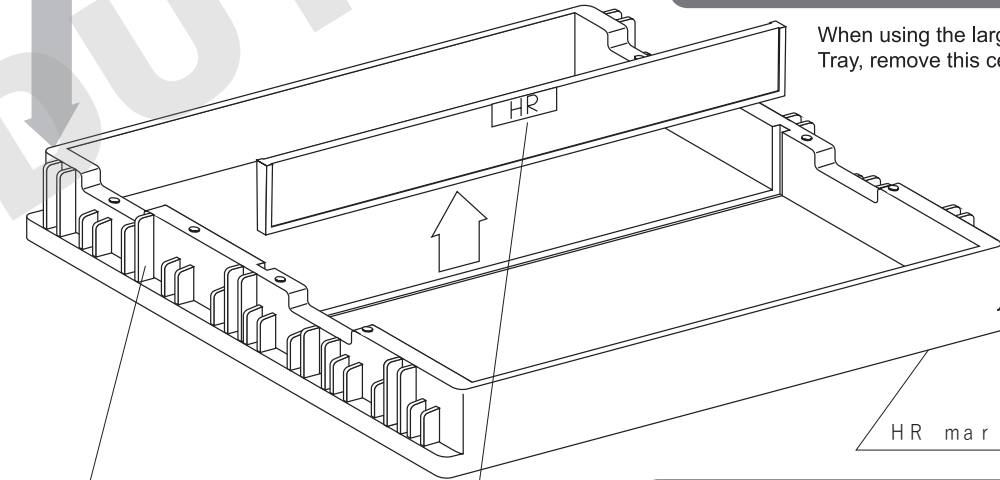

### Comb Setting Sills

Up to four combs can be set in the Stand for large gels, use the small round marks as the setting position (See page 8).

### Gel Casting Stand -HR

Set Gel Trays in this Stand to cast gels.



## 2. Casting Gels

- (1) Place the Casting Stand on a level surface.  
Remove the Center Partition if the large Gel Tray is to be used.

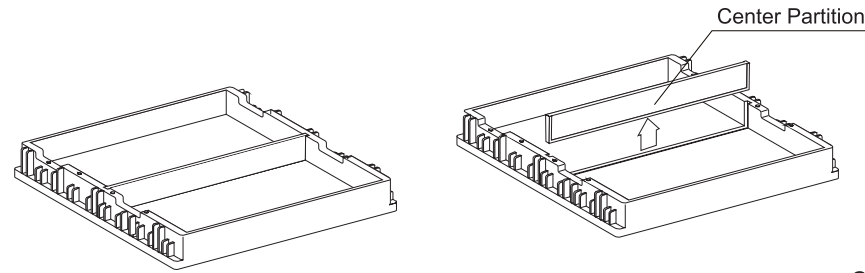

- (2) Place the Gel Tray(s) into the Casting Stand.  
Two small gels can be simultaneously cast.

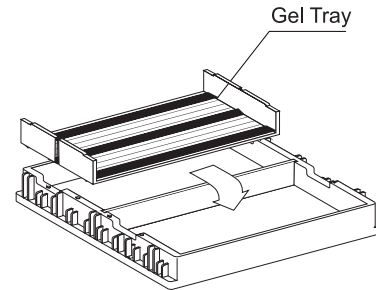

- (3) Weigh the required amount of agarose powder into an appropriate glass flask and add the exact amount of buffer. The choice of heat treatment (such as autoclaving, microwave-treatment and so on) depends on the type of agarose.  
Heat the prepared solution until the agarose has completely dissolved.

- (4) Select either the 13- or 26-toothed Comb in accordance with the experimental requirements, and place the selected Comb into the Casting Stand. The number of samples will depend upon the number of Combs you set in place.

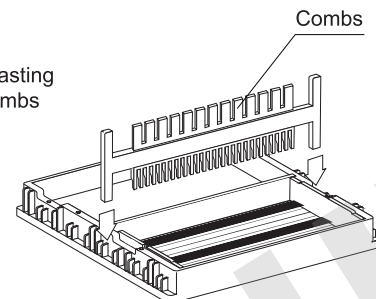

When using four Combs, place in positions with the round marks of the Stand so as to obtain equal intervals.  
The margin of the gel near both electrodes is necessary in achieving more linear movement of analytes (such as DNA).



Setting the Combs in position after having poured in the agarose solution can be applicable. Any air bubbles in the solution or gel of high concentration can be removed by this method in some cases.

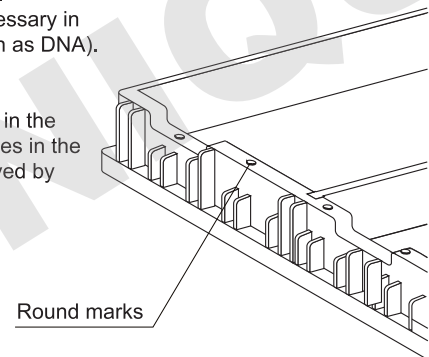

- (5) Pour the prepared agarose solution into the Gel Tray previously set in place in the Gel Casting Stand in the above step 3. The amount of solution to pour depends upon the gel thickness you wish to obtain. About 50 ml of solution is required for a large gel with a thickness of 4mm.  
In the case of Gel Casting Set -HR, agarose solution up to 100°C (212F) can be directly pouring in it.

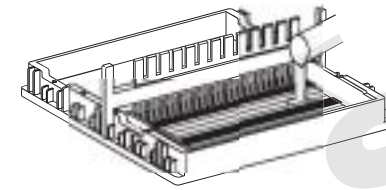

- (6) Please never forget to push the bottom of the Gel Tray with a glass rod to remove any air trapped underneath the Tray; this must be performed before the gel solution begins to solidify.

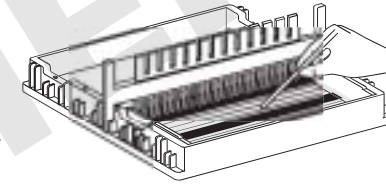

- (7) Allow the gel solution to solidify for about 20 minutes at room temperature. It may take longer in some cases (for example with lower agarose concentrations).

- (8) Remove the Comb(s) with both hands by gently lifting upwards. Check that the gel has completely solidified in rectangular wells and that it is free of air bubbles.

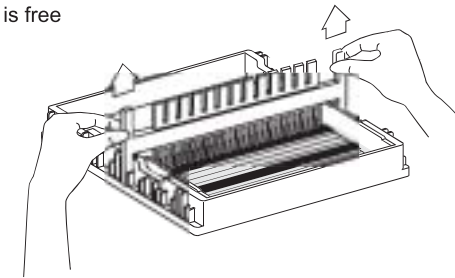

- (9) Hold the Gel Tray at the notches on both sides of the Casting Stand. Pull the Tray upwards. Gel preparation is now complete.

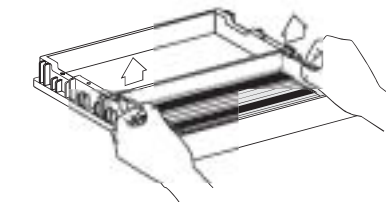

To store gels for later use, keep them in the tray and saturate with a small quantity of running buffer and cover the entire gel (about 3mm above the gel surface) and tray with food protection film or other similar material to protect from desiccation and contamination.

### 3. Performing Electrophoresis

- (1) Connect the Power Supply to the Electrophoresis Cell.



*Mupid-One* shall be used on the level and stable table. In case unit is inclined more than 10 degrees, the buffer liquid in the Cell may spill and/or the precise migration may not be possible.

- (2) After confirming the Main Switch off, connect the power cable to the Power Supply. Plug the Power Supply into a wall outlet.



Ensure an approved power cord that satisfies your regional voltage standard is used.



Input voltage is automatically detected by the system. A transformer is not necessary in any region where the standard voltage is 100 to 240VAC.



Do not put anything in front of the wall outlet so as to disconnect the plug at once in abnormal condition.

- (3) Set the timer. Increase or decrease the value with the Up and Down buttons. 1 minute to 99 minutes can be set as the required run time. Set "0" for continuous run mode ("c" will appear on the display panel).



The LED at the left side of the Run/Pause/Stop button flashing indicates that the timer operation has been paused. To set the timer in this state, push and hold the button to reset the timer.

- (4) Select the required output voltage from 25V, 50V, 100V 135V or ADDITIONAL. In ADDITIONAL mode, you can select 70V, 35V or 18V by using the Voltage Selector (See page 13). Peak voltage is a constant 140V for any output voltage, but the waveform differs according to the selected voltage output. The waveforms are shown in the illustration.

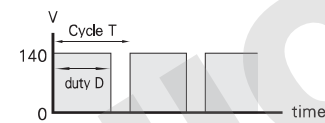
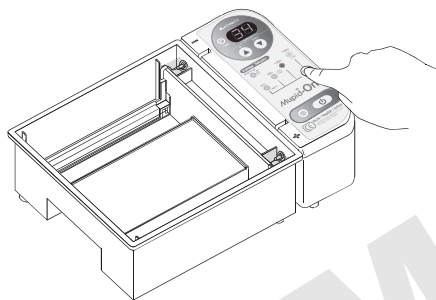

Selected(V)	135	100	70	50	35	25	18
D/T(%)	96	72	50	36	25	18	12



Please pay attention to the temperature increase with electrophoresis using 100V or 135V.

- (5) Place the gel previously prepared onto the gel platform of the Electrophoresis Tank without removing it from the tray. For a large gel, place the tray in such a way that its center groove engages the rib of the Tank. Be careful that the gel does not slide out of the tray.



The near side electrode is the anode. Set the gel so that its wells face the far side for electrophoresis of nucleic acid.

- (6) Pour running buffer into the Electrophoresis Tank to such a level that the gel is submerged approx. 3mm below the buffer.



If too much buffer is poured into the Cell (i.e., over the level mark), the migration current may suddenly increase and the current supply may be cut off by the over-current protection function of this equipment during migration. Please pay attention to the amount of buffer solution used, particularly when using high concentration buffer.

Recommended buffer amount:

- 4mm thick gel in small trays: approx. 340 to 360ml (buffer solution only)
- 4mm thick gel in a large tray: approx. 310 to 330ml (buffer solution only).

- (7) Pipette the desired amount of sample into the wells. Approximately 12  $\mu$ l of sample can be loaded into each 6 mm wide well, and up to approximately 4  $\mu$ l into each 2 mm wide well.

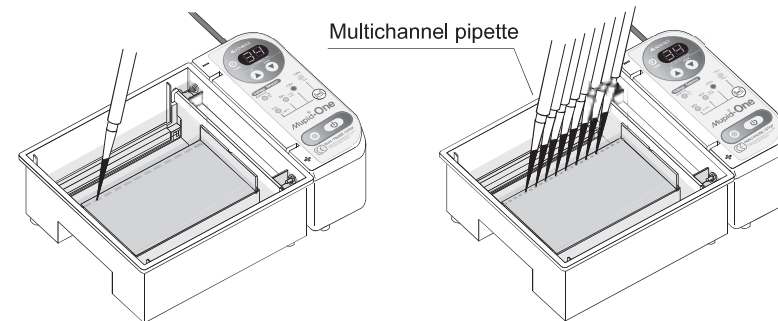

- (8) Set the Safety Lid in place so that the safety bars fit correctly into the slits of the Power Supply.

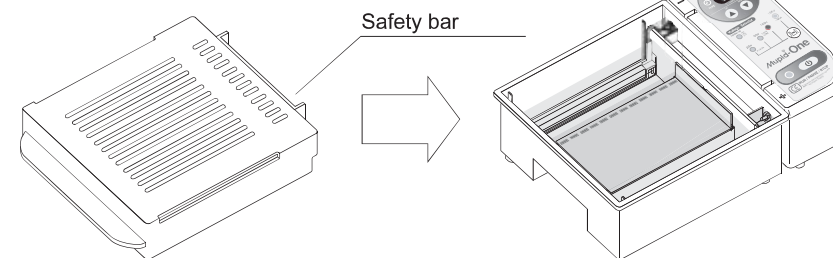

- (9) Press the Run/Pause/Stop button to turn on the Power Supply. The red LED will light up, indicating that system power is on. Check also that air bubbles can be observed from the electrodes as this indicates that power is actually being supplied to the buffer in the Electrophoresis cell.

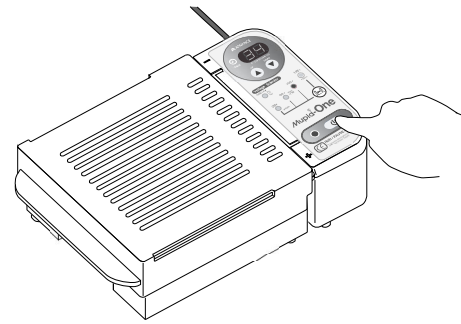

## Display LEDs

**Timer display**

- Remaining time is indicated in minutes on the Timer display, and the LED flashes every second.
- A rolling LED display appears on the panel in continuous run mode.
- Open Error: Indicates that the current is abnormally low, by causes such that the Electrophoresis Cell and the Power Supply are not connected, or that no running buffer is in the Cell. To re-start from this state, please see page 17.
- Over Current shut down: Indicates that the Power Supply has shut down by over-current protection function. The details about this function is described in the next page.

**Output voltage display LED**

The LED indicates when output voltage is selected from 25V, 50V, 100V, or 135V.  
Flashing of one LED: current limiting mode, please see page 13.  
Flashing of four LEDs: over-current mode, please see page 13.

**Voltage Selector**

Press and hold to show the voltage selected for electrophoresis on the display

**Output display LED**

ON: system power is on.  
OFF: system power is off.  
Flashing: system power has been paused.

**Additional Voltages LED**

Turns red when one of the additional voltages (18V, 35V, 70V) is selected. The voltage is shown on the Timer Display when selecting them or pushing the Voltage Selector during operation.

## Setting of Additional voltages

The additional voltages (18V, 35V, 70V) are set as follows :

1. Light the Additional Voltages LED by pressing the Voltage selector.
2. Keep the Voltage selector pressed, then the value of voltage is shown on the Timer display.
3. Change the value with the Down and Up Buttons.
4. Release the Voltage selector to finish setting.

## On pause mode, and re-start

Press the Run/Pause/Stop button when you need to temporarily stop an electrophoresis run. The Output display LED will continuously flash on and off to indicate a temporary shutdown. The remaining time of the timer setting will be retained in the memory. Press the Run/Pause/Stop button to resume the run.



If the Safety Lid is removed during electrophoresis the Power Supply will go into pause mode. Set the lid correctly into position so that the twin bars fit into the slits of the Power Supply. To re-start the run, press the Run/Pause/Stop button.



If the Run/Pause/Stop button is pressed for ca. 2 seconds in pause mode, the timer is reset using the last time memory. To re-start the run, press the Run/Pause/Stop button again.

## Over-current detection and current limiting mode

If the output exceeds the rated voltage, one voltage LED only will continuously flash on and off to indicate current overload. The voltage is automatically adjusted to control the systems output power and the current will be reduced through controlling the power. This does NOT mean the system is "out of order".



If the output exceeds the rated voltage at the start of the run, the voltage control changes to current limiting mode. Therefore, please check whether such mode occurs or not by using buffer and gel without samples.



If you find that the current limiting mode often occurs, change the buffer condition and/or use much lower voltage for runs.



Electrophoresis using 2xTAE or NaOH solution (such as alkaline agarose electrophoresis) is not possible in this device.

## On Shut Down caused by Over-current protection function

The Power Supply is designed to protect against over-current. If current exceeding the equipment capacity is supplied, the Power Supply will automatically shut down and all Output Voltages LEDs will continuously flash on and off to indicate over-current. **Letter 'oC' appears on the Timer Display.** Then, immediately turn the Main switch off and unplug the power cable from the wall outlet. Check to see what has caused the over-current or a short circuit between the electrodes. Verify that there is no problem with the operating conditions.

## Finish of electrophoresis

When the time set on the timer is up, the power automatically turns OFF and an alarm sounds to indicate the operation is complete. If the system is in continuous run mode, ensure the output button is pressed so as to shut the Power Supply off.



As soon as electrophoresis has completed proceed with staining and observation of gels before the bands start to diffuse.



## 4. Recommendable Buffer and output voltage

Buffer	voltage
1xTAE, 0.5xTBE 1xTBE	~ 100V
1xMESA * (40mM MOPS, 10mM sodium acetate, 1mM EDTA)	~ 25V

\* Ref) Methods in Enzymol.,152,61-87,1987

- (1) Recommended buffer amount:  
4mm thick gel in small trays: approx. 340 to 360ml (buffer solution only)  
4mm thick gel in a large tray: approx. 310 to 330ml (buffer solution only).  
Too much or shortage of buffer in the cell cause the Over Current or Open error problems.
- (2) You may not follow above list, migration may be stopped by Over Current protection Function.
- (3) Recommendable Max. migration time with using 135V output voltage is less than 30 minutes.

## 5. Observation of sample bands (example)

- (1) Remove the Lid, and take out the gel with the Gel tray from the Electrophoresis Cell.
- (2) Prepare the stain solution in a suitable container, and put the gel into it without the Gel tray.
- (3) After staining, observe the fluorescence through the gel above the UV illuminator.

 Some stain reagents are known to react with DNA and other biomolecules, and are health hazards. Extreme care is required when handling these reagents to avoid exposing your skin to them.

 Follow appropriate hazardous materials disposal regulations according to the applicable instruction manuals when disposing of gels, buffers and staining solutions after use. Thoroughly wash and clean the Electrophoresis Tank and Gel Trays if they are contaminated with staining agent solution.

 To disassemble the Cell from the Power Supply, remove gently the Lid as shown in the illustration by using the handle of the Lid as a fulcrum to turn off the Power Supply.

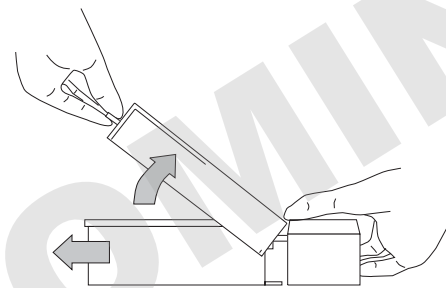

## 6. Maintenance

Cleaning is the only routine maintenance required on the *Mupid-One*



Do not store electrophoresis buffer in the Electrophoresis Cell. Over the time the buffer starts crystallizing on electrodes and will effect the results of electrophoresis or may permanently damage the platinum electrodes. It is recommended to discard buffer after electrophoresis and rinse the Cell with distilled water. Storing the *Mupid-One* components clean and dry will extend the life of the system and ensure trouble-free operation.



Be sure to disconnect the *Mupid-One* Power Supply from the Cell and unplug the power cable from the wall outlet before lifting the Cell to discard buffer or clean the device.



Be careful not to brush or disrupt the electrodes when cleaning the Cell. Electrophoresis buffer and agarose are best cleaned with running water. Rinse the Cell with distilled water and leave open to dry.



In cleaning the Power Supply, wipe it with a cloth that includes mild detergent and is squeezed enough.



Do not autoclave any components of the *Mupid-One* device and the Cell.



Do not use bleach, organic solvents or any other aggressive solutions to clean the system.



The *Mupid-One* Electrophoresis System should not be modified or altered in any way.



The *Mupid-One* Electrophoresis Cell is designed to be used only with the *Mupid-One* Power Supply. Using the Cell with any other power supply or using the *Mupid-One* Power Supply with an unauthorized electrophoresis Cell will disable the safety features and may result in accidental electrical shock and possible user injury. ADVANCE Co.,Ltd is not responsible for any injury or damage caused by the use of unauthorized components.



## 7. Trouble shooting

Problem	Possible cause and/or Corrective action
<b>The Power Supply LED does not light up</b>	<ul style="list-style-type: none"> <li>• The power cable is not plugged into a wall outlet or not connected to the Power Supply.</li> <li>• Any LED doesn't light if the Lid is not set correctly.</li> <li>• The power cable does not satisfy your regional voltage standard in use.</li> <li>• The fuse has blown. • Verify buffer concentration.</li> <li>• The equipment has overheated. If it has, unplug the power cable from the wall outlet. Ensure that nothing has covered the vent holes on the Power Supply. Place the Power Supply somewhere ventilated and cool for a while.</li> </ul>
<b>Impossible to set the Power Supply conditions</b>	<ul style="list-style-type: none"> <li>• On the case that setting is not possible during electrophoresis. Press the Run/Pause/Stop button to shut it down.</li> <li>• If in the pause-mode (the LED will be flashing on and off), press the Run/Pause/Stop button continuously for about 2 seconds so as to reset the timer.</li> </ul>
<b>No output voltage</b>	<ul style="list-style-type: none"> <li>• Press the Run/Pause/Stop button.</li> <li>• Position the safety lid properly.</li> <li>• Gel is not fully submerged in running buffer and/or has dried up.</li> <li>• The electrodes or copper wire around them may have broken.</li> </ul>
<b>Migration stops</b>	<ul style="list-style-type: none"> <li>• The volume of running buffer is too high, its concentration is too high and/or its temperature is too high. The buffer may have high conductivity.</li> <li>• The running buffer is being re-used and may have higher conductivity due to loss of water.</li> <li>• The main switch is OFF or the cable has detached from the Power Supply or wall outlet.</li> </ul>
<b>Low mobility (Slow sample migration)</b>	<ul style="list-style-type: none"> <li>• The voltage is not set to the correct value.</li> <li>• The type and/or concentration of buffer greatly affects mobility.</li> <li>• Higher conductivity in samples to be separated. Dilute or prepare new samples using the correct procedure and solution (for example, usage of phosphate-buffered saline as sample suspension buffer is not acceptable in electrophoresis).</li> <li>• The running buffer is being re-used so it may have higher conductivity due to loss of water.</li> <li>• It may be in current limiting mode. If the output exceeds the rated voltage, only one voltage LED will continuously flash on and off to indicate current overload. Voltage is automatically adjusted to control the systems output power. For more details, please see page 13.</li> </ul>
<b>Distorted bands</b>	<ul style="list-style-type: none"> <li>• Air bubbles are trapped inside the gel.</li> <li>• The agarose was not fully dissolved at the gel preparation step.</li> <li>• The electrophoresis cell is not level. Unevenness should be avoided with submerged electrophoresis.</li> <li>• The running buffer is being re-used so in most cases it will not have constant pH and conductivity and will greatly affect electrophoresis mobility.</li> </ul>

Problem	Possible cause and/or Corrective action
<b>No band can be observed</b>	<ul style="list-style-type: none"> <li>• The concentration of the staining solution is low and/or has been used too many times. Small volume of solution compared to the volume of the gel.</li> <li>• Extended staining period may result in a higher signal, or a shortened period may result in a lower background.</li> <li>• Sample volume or amount is insufficient for detection.</li> <li>• For fluorescence observation, use the correct excitation wavelength for the fluorochrome. Too much illumination can degrade the fluorochrome, resulting in faint fluorescence.</li> <li>• Observe the fluorescence through the gel above the UV illuminator.</li> <li>• The sample has moved out of the gel for some reason.</li> <li>• The sample does not move or moves in an unexpected direction. Try using a shorter electrophoresis period.</li> <li>• Samples diffuse due to too much time elapsing after electrophoresis.</li> </ul>
<b>Letter 'oP' appear on the Timer display.</b>	<p>Electric currency does not flow in the cell. Please make sure</p> <ol style="list-style-type: none"> <li>a) Power supply connects with the cell properly.</li> <li>b) Buffer is in the cell.</li> <li>c) Lid is put on the cell and connects with power supply properly.</li> </ol> <p>After these confirmation, re-start the migration as follows:</p> <ol style="list-style-type: none"> <li>1) Push the Run/Pause/Stop Button. Then, the Power Supply will go into pause mode.</li> <li>2) Push the Run/Pause/Stop Button again, and the Power Supply will re-start the run.</li> </ol>
<b>Letter 'oC' appear on the Timer display.</b>	<p>The Power Supply has shut down by Over-Current protection function. Please see page 13 to know what to check and how to re-start.</p>

## 8. Specifications

### Electrophoresis Cell

Overall dimension	183mm(W) × 59mm(H) × 162mm(L)
Solution volume	about 410 - 440ml (includes buffer and gels)
Quantity	1

### Safety Lid

Overall dimension	197mm(W) × 38mm(H) × 179mm(L)
Material characteristic	transparent resin
Quantity	1

### Power Supply

Overall dimension	75mm(W) × 62mm(H) × 170mm(L)
Weight	410 g
Input Voltage	100VAC - 240VAC, 50/60Hz
Output Voltage	135V, 100V, 50V, 25V, 70V, 35V, 18V Constant peak voltage of 140V, and duty-control
Timer	Timer operation 0 - 99min, and continuous mode Temporary shutdown supported
Safety Switch	Micro-switches in the Power Supply Without safety lid, no output of Power
Fuse type	250V 2A type T Diameter=5mm Length=20mm
Memory Function	Automatic memory (the last used V and T)
Quantity	1

### Gel Tray -HR

Gel tray(small)	130mm(W) × 16.5mm(H) × 59.5mm(L)
Gel tray(large)	130mm(W) × 24mm(H) × 122mm(L)
Quantity	small: 2, large: 1

### Comb -HR

Multiple number of wells	13 - 26 Wells 13 wells: 9mm spacing 26 wells: 4.5mm spacing
Quantity	4 (supports making 13 or 26 wells)

### Gel Casting Stand -HR

Overall dimension	149mm(W) × 20mm(H) × 128mm(L)
Quantity	1

### Center Partition -HR

Overall dimension	135mm(W) × 16.5mm(H) × 3mm(T)
Quantity	1

## 9. Operating Environment for Power Supply

Use this product under the following conditions (limited as indoor use) :

Altitude	Up to 2000 meters
Operating Temperature	5°C to 40°C
Operating Humidity	maximum relative humidity 80% for temperatures up to 31°C decreasing linearly to 50% relative humidity at 40°C
MAINS Supply Voltage	100V to 240V with fluctuation up to ± 10% of the nominal voltage
Transient Overvoltage	Overvoltage category II
Pollution Degree	II

## 10. Please Note

Please request the check or the repair of this product to the dealer or manufacturer(ADVANCE Co.,Ltd.).

Before returning this product or any accessories back to your authorized distributor or service agency, please make sure that it has been properly decontaminated and is free of biological and chemical contaminants.