

TH

Tissue Homogenizer

User Manual

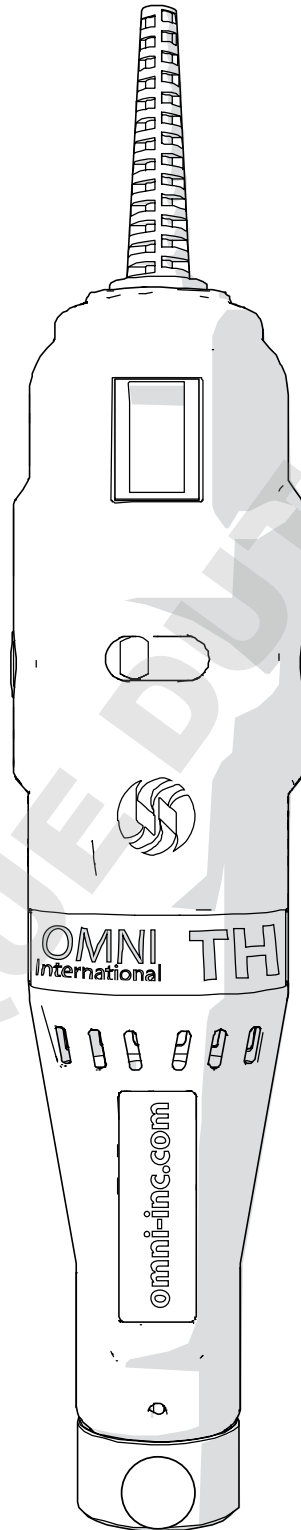

OMNI
International
The Homogenizer Company®

This manual is a guide for the use of the Omni International TH, Tissue Homogenizer and accessories.

Data herein has been verified and validated. It is believed adequate for the intended use of the instrument. If the instrument or procedures are used for purposes over and above the capabilities specified herein, confirmation of the validity and suitability should be obtained, otherwise Omni International does not guarantee results and assumes no obligation or liability. This publication is not a license to operate under, or a recommendation to infringe upon, any process patents. Notes, cautions, and warnings within the text of this manual are used to emphasize important and critical instructions.

This Omni International product is warranted to be free from defects in material and workmanship for a period of TWO YEAR from the date of delivery. Omni International will repair or replace and return free of charge any part which is returned to its factory within said period, transportation prepaid by user, and which is found upon inspection to have been defective in materials or workmanship. For the first 90 days, both parts and service are without charge. For the balance of the period, parts will be provided but service will be charged at established labor rates. This warranty does not include normal wear from use; it does not apply to any instrument or parts which have been altered by anyone other than an employee of Omni International nor to any instrument which has been damaged through accident, negligence, failure to follow operating instructions, the use of electric currents or circuits other than those specified on the plate affixed to the instrument, misuse, or abuse. Omni International reserves the right to change, alter, modify, or improve any of its instruments without any obligation whatsoever to make corresponding changes to any instrument previously sold or shipped.

THE FORGOING OBLIGATION IS IN LIEU OF ALL OBLIGATIONS AND LIABILITIES INCLUDING NEGLIGENCE AND ALL WARRANTIES OF MERCHANTABILITY OR OTHERWISE, EXPRESSED OR IMPLIED IN FACT OR BY LAW, AND STATE OUR ENTIRE AND EXCLUSIVE LIABILITY AND BUYERS EXCLUSIVE REMEDY FOR ANY CLAIM OF DAMAGES IN CONNECTION WITH THE SALE OR FURNISHING OF GOODS OR PARTS, THEIR DESIGN, SUITABILITY FOR USE, INSTALLATION, OR OPERATION. OMNI INTERNATIONAL WILL IN NO EVENT BE LIABLE FOR ANY SPECIAL OR CONSEQUENTIAL DAMAGES WHATSOEVER, AND THEIR LIABILITY UNDER NO CIRCUMSTANCES WILL EXCEED THE CONTRACT PRICE FOR THE GOODS FOR WHICH LIABILITY IS CLAIMED.

- READ ALL INSTRUCTIONS BEFORE USING.

The Omni TH has been engineered for economical functionality as well as safety; however, basic safety precautions and common sense must always be demonstrated when using any electrical product. DO NOT attempt to modify any part of the Omni TH. If you experience problems with or have questions about your Omni TH, contact your authorized dealer or call Omni International at 1-800-776-4431 or 1-770-421-0058.

- DO NOT allow the machine to be submerged in any liquid.
- DO NOT use in any setting other than an indoor laboratory.
- DO NOT plug power cord into an incorrect outlet.

To reduce the risk of burns, electrocution, fire, or injury:

- Use this product only for its intended purpose as described in this booklet. DO NOT use attachments not recommended by the manufacturer.
- DO NOT operate the product if it is damaged in any way.
- Keep this product away from heated surfaces.

WARNING: The tip of the saw tooth generator probe is sharp.

WARNING: Reduce the risk of unintentional starting; make sure that the power switch is in the OFF position prior to plugging in the unit.

WARNING: The Omni TH, Tissue Homogenizer has an internal speed control. An external speed control should never be used with this instrument.

WARNING: DO NOT process pathogenic material in an open container, since aerosols created during normal processing could be inhaled by the operator. Please call for assistance in processing pathogens or other material which require sealed enclosures.

WARNING: Keep all housings in place and in working order.

WARNING: Remove all tools from the generator probe before turning the motor on.

WARNING: DO NOT use the motor in a dangerous environment.

WARNING: Disconnect the motor before servicing, and when changing the generator probe.

WARNING: DO NOT modify the plug or cord that is provided. If the plug will not fit the outlet, have the proper outlet installed by a qualified electrician.

WARNING: Reduce the risk of unintentional starting; make sure the power switch is in the OFF position before plugging in the motor.

WARNING: Damaged or worn power cords should be repaired or replaced immediately by a qualified electrician.

WARNING: Improper connection of the equipment can result in a risk of electric shock.

DECONTAMINATION

Should an instrument or component that has been used with radioactive or pathogenic material require factory or field service, comply with the following procedure to ensure the safety of service personnel:

Clean the parts to be serviced of all encrusted material and decontaminate them. There must be no radioactivity detectable by survey equipment. Obtain a Decontamination Certificate from Omni International. Complete the certificate and attach to the instrument or parts being returned. If no Decontamination Certificate is attached, and a potential radioactive or biological hazard is detected or suspected by Omni International, the equipment will not be serviced until proper decontamination and certification is complete. The sender will be contacted for instructions as to the disposition of the equipment. Disposition costs will be borne by the sender.

WARNING: It is a violation of federal law to transport biologically hazardous or radioactive materials without proper packaging, labeling, and appropriate warnings.

Should this product ever require service, please contact
Omni International at 1-800-776-4431

Overview

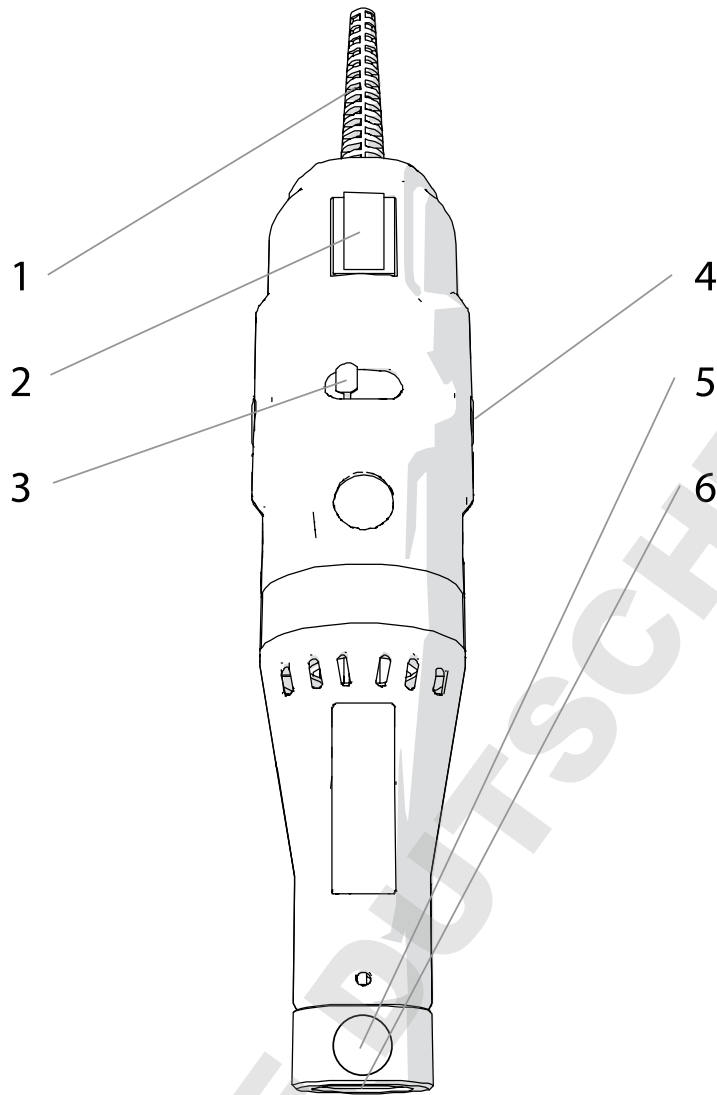

- 1. Power Cord
- 2. On/Off Switch
- 3. Variable Speed Control
- 4. Motor Brushes
- 5. Thumb Screw
- 6. Probe Coupling

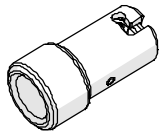

Adapter
12-120

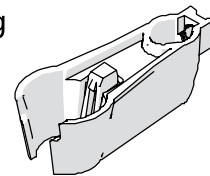

Clamp
12-118

The Omni TH consists of the following:

Description	Part Number	Quantity
Motor Drive Unit (110V)	TH-01	1
Or Motor Drive Unit (220V)	TH-02	1
Clamp	12-118	1
Tool Kit	T1001	1
Soft Tissue Omni Tip	(sample)	1
Hard Tissue Omni Tip	(sample)	1
Omni Tip Adapter	12-120	1
Instruction Manual	H258-TH	1

Optional Stand Available (sold separately) - Order No. S1000

Stand Mounting

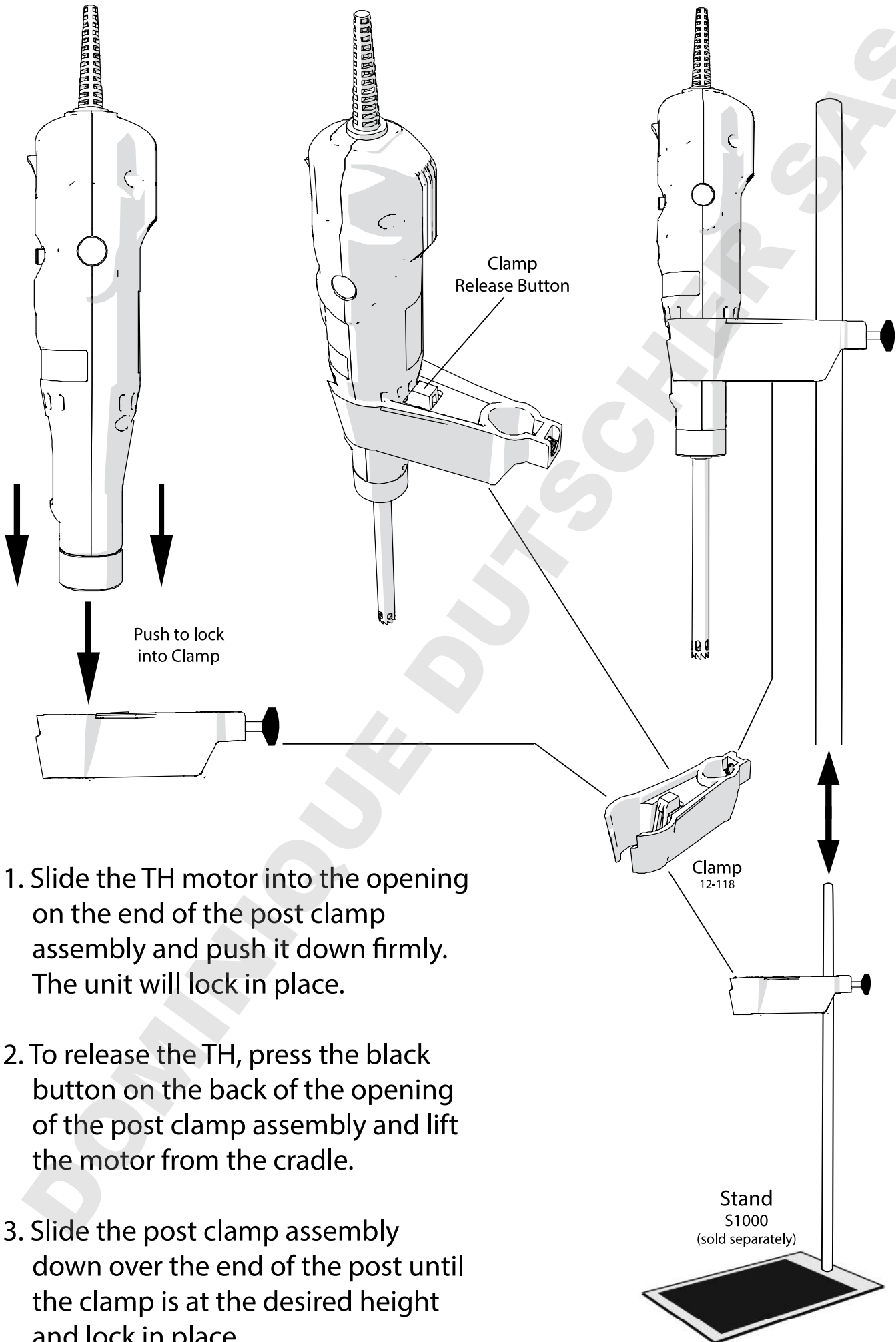

Accessories

Generator Probes

1. Insert Generator Probe into coupling

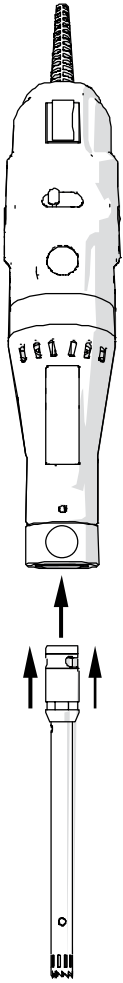

2. Quarter turn clockwise to lock

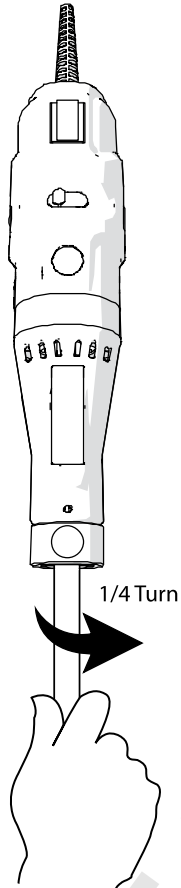

3. Tighten Thumbscrew

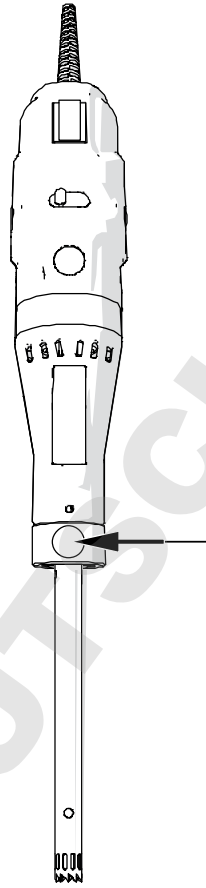

4. Ready to use
*always submerge probe in liquid before starting

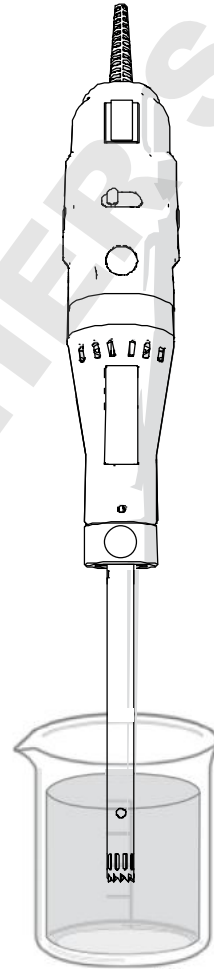

*Never run dry

Omni Tips™ and Adapter

1. Insert Adapter into coupling

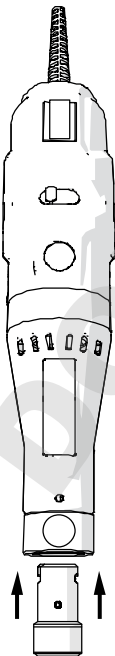

2. Tighten Thumbscrew

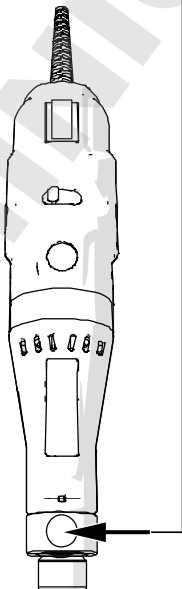

3. Insert Omni Tip™ into adapter

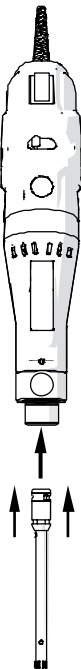

4. Quarter turn clockwise to lock

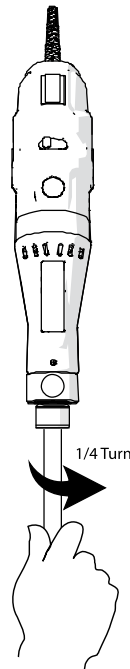

5. Ready to use
*always submerge probe in liquid before starting

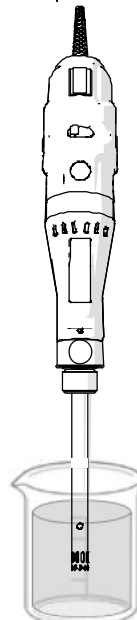

*Never run dry

Stainless Steel Generator Probes

Size	Processing Range	Type	Resulting Particle Size	Order No.
5 mm	.020 mL - 5 mL	Flat Bottom	Fine	G5-75
		Flat Bottom - Wide Window	Coarse	G5-75W
7 mm	.25 mL - 30 mL	Flat Bottom	Fine	G7-95
		Flat Bottom - Wide Window	Coarse	G7-95W
		Saw Tooth	Fine	G7-115ST
		Saw Tooth - Wide Window	Fine	G7-115STW
10 mm	1.5 mL - 100 mL	Saw Tooth	Fine	G10-115
		Saw Tooth - Wide Window	Coarse	G10-115W

Omni Tips®
Plastic
Disposable
Generator
Probes

Type	Size	Quantity	Order No.
Hard Tissue	7 mm x 110 mm	25 Pack	30750H
	7 mm x 110 mm	50 Pack	32750H
Soft Tissue	7 mm x 110 mm	25 Pack	30750
	7 mm x 110 mm	50 Pack	32750
	Adapter	1	A1000SB

(required for plastic probes)

Operation

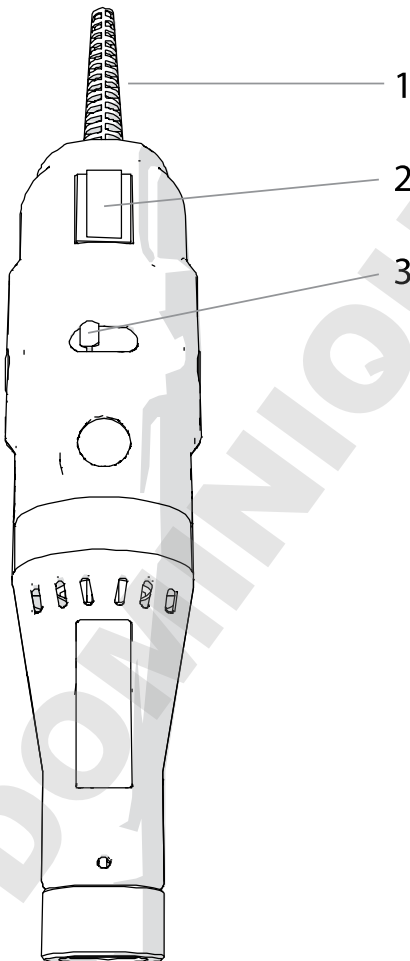

1. Power Cord
2. On/Off switch
3. Variable Speed Control

General Operation

Power

- Plug in the power cord

Start

- Move the On/Off switch on the front of the unit to the On position.

Set Speed

- Adjust speed using the variable speed control. To increase rpm, move control from left to right

Stop

- Move the On/Off switch on the front of the unit to the Off position.

Troubleshooting

PROBLEM	CORRECTIVE ACTION
The Omni TH is plugged in and turned on but is not functioning.	<ul style="list-style-type: none">- Check power cord connectors- Check wall socket for power to the outlet
Motor is turned ON and makes a "buzzing" sound, but is not working.	<ul style="list-style-type: none">- Check that the brushes are not worn and are correctly installed.
Motor unit operating speed declines, stalls intermittently, or stops completely	<ul style="list-style-type: none">- Check that the brushes are not worn and are correctly installed.
PTFE bearing wears quickly	<ul style="list-style-type: none">- Fluid level may be too low in the tube.- Immerse the probe deeper into the fluid.

DOMINIQUE DUTSCHER SAS

DOMINIQUE DUTSCHER SAS



OMNI
International

935C Cobb Place Blvd.
Kennesaw, GA 30144
800.776.4431 • 770.421.0058
www.omni-inc.com



PN: H258-TH Rev. D