



**Thermo Scientific
Microplates Guide**

superior performance
in virtually every application

DOMINIQUE DUTS

Thermo
SCIENTIFIC



sample integrity

Thermo Scientific microplates

The quality and breadth of the Thermo Scientific™ line of multi-dishes, microplates, microplate accessories and microplate sealers are unmatched in the industry. Researchers around the world rely on our 55 years of experience manufacturing Thermo Scientific™ Nunc™ microplates, and regard Nunc quality as the standard by which all microplates are measured. Whether you're culturing individual cell lines or scaling up for high-throughput screening, or anything in between – there's a Nunc microplate for your needs.

The range of Thermo Scientific adhesive seals, heat seals and heat sealers offers reliable options for maintaining the integrity of your plate contents, allowing you to store your samples confidently. For added assurance in tracking stored samples, rely on Nunc custom barcoding to simplify your tracking and inventory management.

With so many variables in your research, don't let consumables get in the way of progress. Choose only Thermo Scientific products – the most reliable microplates and accessories available.

For an online guide to help you select the best plate for your research, and to download complete specification drawings, visit: thermoscientific.com/plateguide

Download our app today to use your mobile device for a quick search, share information with colleagues and save your favorites in the “my lab” folder.

Visit the app store and search: *plate guide*.

Thermo Scientific Products:

| | | | |
|--|----|---|----|
| Assay Dishes/Multi dishes | | Nunc Microplate Lids | |
| Nunc BioAssay Dishes | 8 | Lids | 46 |
| Nunc Rectangular Dishes | 9 | | |
| Nunc Glass Bottom Dishes | 9 | Scanners/Storage Racks | |
| Nunc OmniTray | 10 | Nunc Barcode Scanners | 48 |
| Nunc Immuno TSP | 10 | Nalgene Storage Racks for Microplates | 49 |
| Nunc Multidishes | | Nunc Horizontal Microplate Plastic Storage Racks | 49 |
| Cell Culture Treated | 11 | Nunc Vertical Microplate Storage Racks | 50 |
| Nunc Sphera Surface | 12 | | |
| UpCell Surface | 13 | Washers/Replication System/Reservoirs | |
| Poly D-Lysine or Collagen I Coated | 14 | Nunc Immuno Washers | 51 |
| Nunc Vita Surface | 15 | Nunc Replication System | 52 |
| Bidite Products | 16 | Nalgene Disposable Polypropylene Robotic Reservoirs | 53 |
| Non-treated | 17 | | |
| 96-Well Plates | | Sealing | |
| Nunc Edge 96-Well Plates | 19 | 96-Well Cap Mats | 54 |
| Flat Bottom 96-Well Clear Polystyrene Plates | 20 | Nunc Adhesive Sealing Tapes | 55 |
| Flat Bottom 96-Well Black and White Polystyrene Plates | 22 | SuperSealer | 56 |
| Round Bottom 96-Well Clear Polystyrene Plates | 24 | ALPS25 Manual Heat Sealer | 57 |
| Conical Bottom 96-Well Clear Polystyrene Plates | 26 | ALPS50 VMicroplate Heat Sealer | 58 |
| 96-Well UV Plates | 27 | ALPS3000 Automated Microplate Heat Sealer | 59 |
| Nunc C96-Well Clear Polystyrene Microplates | 27 | Heat Seals | 60 |
| Nunc 96-Well Optical-Bottom Plates with Polymer Base | 28 | | |
| Nunc 96-Well Optical-Bottom Plates with Coverglass Base | 29 | | |
| 96-Well Polypropylene Plates | 30 | | |
| 96-DeepWell Polypropylene Plates | 32 | | |
| Nunc 96-DeepWell Polystyrene Plates | 34 | | |
| Nunc 96-Well Filter Plates | 35 | | |
| 384-Well Plates | | | |
| 384-Well Polystyrene Plates | 36 | | |
| Nunc 384-Well Shallow Well Standard Height Plates | 38 | | |
| Nunc 384-Well Optical Bottom Plates | 39 | | |
| 384-Well Polypropylene Plates | 40 | | |
| Nunc 384-ShallowWell Standard Height Polypropylene Microplates | 41 | | |
| Nunc DeepWell 384-Well Plates | 43 | | |
| 1536-Well Plates | | | |
| Nunc 1536-Well High Base Microplates | 44 | | |
| Nunc 1536-Well Microplates | 45 | | |

Surface Selection Guide for Cell Based Assays

To help ensure the most flexible, reproducible and reliable results across every stage of cell culture, we offer an extensive range of products spanning a variety of formats, sizes and surfaces. The following charts will help guide product selection, with specific cell types and desired cell culture ranges in mind.

Select Your Surface

| Thermo Scientific Cell Culture Surfaces | | Nunclon Delta | Nunclon Vita | Collagen I | Poly-D-Lysine | Nunclon Sphera | UpCell | Untreated Surface | |
|---|-------------------|---|--------------|------------|---------------|----------------|--------|-------------------|---|
| Cell Types | Hepatocytes | • | • | • | | | • | | |
| | Endothelial Cells | • | | • | | | • | | |
| | Neuronal Cells | Neuronal Cells | • | | | • | | • | |
| | | Neurosphere | | | | | • | | |
| | Epithelial Cells | • | • | • | | | • | | |
| | Tumor Cells | • | • | • | • | • | • | | |
| | Blood Cells | Macrophages, Dendritic Cells, Neutrophils | • | | | | | • | |
| | | Lymphocytes | • | | | | | | • |
| | | Platelet | • | | • | | | • | |
| | Stem Cells | MSC | • | • | | | | • | |
| HSC | | • | | | | | | | |
| ESC | | •* | •** | | | | | | |
| EB | | | | | | | | | |

* Requires matrix coating.

** Requires conditioned media from feeder cells and ROCK inhibitor.

Distinction is our legacy. For more than 50 years,

Thermo Scientific cell culture products have been a cornerstone of quality and dependability among researchers and scientists worldwide.

Today, our cell culture portfolio is built on a framework of innovative surface technologies and formats that achieve optimal consistency and growth across a variety of cell types – representing traditional as well as stem cell lines.



surface selection guide

| Thermo Scientific Cell Culture Surfaces | | Nunc Delta | Nunc Vita | Collagen I | Poly-D-Lysine | Sphera | UpCell | Untreated Surface | |
|---|--|------------|-----------|------------|---------------|--------|--------|-------------------|---|
| Multidishes and Microplates | 1.1-1.9/well Culture Area Range (cm ²) | 4-well | • | | | | | • | |
| | | 6-well | • | • | • | • | • | • | |
| | | 12-well | • | | | | • | • | • |
| | | 24-well | • | | | | • | • | • |
| | | 48-well | • | | | | • | • | • |
| | | 96-well | • | | • | • | • | • | • |

| Number of Wells | Throughput | Automation |
|----------------------------|--------------------|------------|
| 1, 4, 6, 8, 12, 16, 24, 48 | Low to medium | As needed |
| 96 | Moderate | Common |
| 384, 1536 | High to ultra-high | Necessary |

| Plate Type | Description | Material | Applications |
|----------------|--|--|---|
| Solid | Single molded plate, one piece with solid bottom | Polypropylene (PP) or Polystyrene (PS) | Cell culture, homogeneous assays, ELISA, fluorescence, luminescence, storage |
| Optical Bottom | Black or white upper structure with clear bottom | PS upper structure with polymer or glass base | Cell imaging and assays, fluorescence |
| Filter | 96 well 1 mL plate with filters or binding membranes | PP plate with Polyethylene (PE) frit or frit plus glass fiber membrane | Filtration of cell debris and genomic DNA. Purification of plasmid DNA and PCR products |

| Well Abbreviation | Bottom Shape | Advantages |
|-------------------|---------------------------------|--|
| F | Flat Bottom | Optical imaging, cell culture |
| C | Rounded Corners and Flat Bottom | Advantages of flat bottom with efficient washing |
| U | Round Bottom | Optimal washing, mixing, examination of pellet |
| V | Conical Bottom | Precipitation, centrifugation, small volume recovery |

| Plate Color | Key Application |
|-------------|--|
| Clear | Colorimetric Assays, Cell Culture, ELISA |
| Black | Fluorescent Assays |
| Natural | Storage |
| White | Luminescent Assays |
| Red | Available Choice |
| Blue | Available Choice |
| Yellow | Available Choice |

| Material | Chemical Resistance | Binding Capacity | Plastic Characteristics | Applications |
|--------------------|---------------------|---|-------------------------|---|
| Polystyrene (PS) | Low | Low to very high depending on surface treatment | Hard, clear | Homogeneous assays, ELISA, cell culture, fluorescence, luminescence |
| Polypropylene (PP) | High | Very low | Softer, more opaque | Storage, fluorescence, luminescence |

Mechanism of Action

Energy treatment

The energetic surface oxidation improves polystyrene surface hydrophilicity and results in generation of both hydroxyl and carboxyl functional groups. The presence of these hydrophilic groups facilitates the protein unfolding needed for cell attachment.

Extracellular matrix (ECM) coating

Passive adsorption of biological materials such as ECM facilitates the adhesion of finicky cells by mimicking the action of basal lamina substrates on cell culture surfaces.

Polymer graft

Covalent binding of polymers to polystyrene enables special functions to the cell culture surface (e.g. super-hydrophilic polymer prevents cells from adhering to Low Cell Binding and HydroCell surfaces; thermoresponsive polymer enables enzyme-free detachment of cells by reducing the external culture temperature).

Untreated polystyrene

The smooth and hydrophobic polystyrene surface allows non-adherent cell culture at low cost.

Choice of Surface



Surface for passive binding

Schematic representation of the types of biomacromolecules, which can be bound to the available modified surfaces. Eg. if a lipid is to be bound, the hydrophobic surface Thermo Scientific[™] Nunc[™] PolySorp[™] is most suitable. Based on the physiochemical characteristics of the biomolecule to be immobilized, a surface can be chosen which is appropriate for robust binding. Thermo Scientific[™] Nunc[™] MaxiSorp[™] has the widest breadth applications, as it is capable of binding the greatest range of molecules.

Surface characteristics:

- Adsorb larger biomolecules
- Different molecular orientations are possible
- A variety of surfaces are available for performance optimization



Covalent coupling surfaces

The diagram shows the available surface modifications for directed binding of target biomolecules. In the case of the Thermo Scientific[™] Immobilizer[™] Amino and Thermo Scientific[™] Covalink[™], a strong covalent bond is formed with the biomolecule being immobilized at the surface. The biomolecule must possess the correct functional group for covalent coupling.

The diagram shows the available surface modifications for directed binding of target biomolecules.



Affinity capture surfaces

The diagram shows the available surface modifications for directed binding of target biomolecules.

Thermo Scientific Nunc BioAssay Dishes Square



Thermo Scientific™ Nunc™ Square BioAssay Dishes are useful as incubation chambers for in-situ hybridization and suitable for agar diffusion assays.

Used for culturing bacteria, yeast and fungi. Also suitable as a moisture chamber for incubation of Thermo Scientific Nunc Microwell Plates.

details

- Optically-clear
- Large growth area
- Low profile design fits robotic instruments
- Designed for genomic screening and colony picking
- Untreated
- Sterile
- Supplied with lid

Nunc BioAssay Dishes

| Cat. No. | Description | Working Volume, mL | L x W x H mm | Working Vol., mL | Surface Area, cm ² | Nb. per Pack | Nb. per Case |
|----------|-------------------------------|--------------------|----------------|------------------|-------------------------------|--------------|--------------|
| 240835 | Standard Height BioAssay Dish | 225 | 245 x 245 x 25 | 225 | 500 | 4 | 16 |
| 240845 | Low Profile BioAssay Dish | 215 | 241 x 241 x 20 | 215 | 478 | 5 | 20 |

Thermo Scientific Nunc Rectangular Dishes



Nunc Rectangular Dishes have ANSI standard dimensions and are optimized for robotics.

The non-treated surface is ideal for molecular biology applications.

details

Rectangular Dishes 1-, 4- and 8-well

- 1-well dish is ideal for HTS Petri dish applications
- 4- and 8-well dishes are ideal for assay compartmentalization, probe multiple gene sub-set
- 4-well dish holds four glass slides for storage

1-Well Format

- Convenient plate format for cell culture
- HTS Petri dish applications

4- and 8-Well Formats

- Assay compartmentalization
- Probe multiple gene subsets
- Wash Western blot strips
- Useful in all areas of cell culture, including scale-up and cloning

Compliance: All Nunc microplates meet the recommendation of American National Standards Institute (ANSI).

Nunc Rectangular Dishes

| Cat. No. | Total Vol., μL | Wells | L x W, mm | Sterile | Lid | No. per Pack | No. Per Case |
|----------|---------------------------|-------|-----------|---------|-----|--------------|--------------|
| 267060 | 90 | 1 | 128 x 86 | Yes | Yes | 10 | 100 |
| 267061 | 22 | 4 | 128 x 86 | Yes | Yes | 10 | 100 |
| 267062 | 11 | 8 | 128 x 86 | Yes | Yes | 10 | 100 |

Thermo Scientific Nunc Glass Bottom Dishes

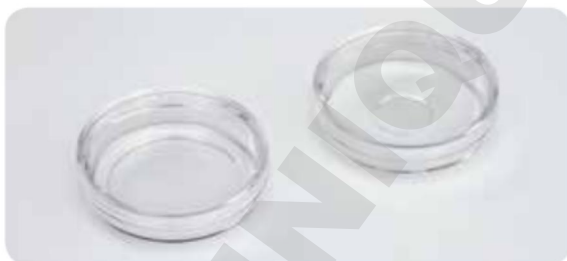

Nunc Glass Bottom Dishes give you the flexibility to convert your culture device into an imaging device. This means you keep the same seeding density, media volume and culture conditions.

The Nunc glass bottom dish combines the convenience of a standard 35 mm cell culture dish with the imaging benefits of coverglass to provide the optimum optical characteristics required for high-magnification microscopy and confocal image analysis.

details

Ideal for observation at high magnification:

- Fluorescence, phase contrast, and confocal microscopy
- Live cell imaging
- Differential interference contrast microscopy
- Fluorescence in situ hybridization (FISH)

Nunc Glass Bottom Dishes

| Cat. No. | Description | No./Pack | No./Case |
|----------|-------------------------------|----------|----------|
| 150680* | Nunc Glass Bottom Dish, 12 mm | 1 | 20 |
| 150682 | Nunc Glass Bottom Dish, 27 mm | 1 | 20 |

* Glass Bottom Dishes are not available in Japan

Thermo Scientific Nunc OmniTray



Nunc OmniTrays are ideal for screening libraries, DNA hybridization, standard petri dish techniques and bacterial growth.

details

- Clear polystyrene has excellent optical properties making it ideal for optical measurements and colony counting; can be frozen at -20°C
- Untreated polystyrene is hydrophobic and is suited for growth of suspension cultures that can proliferate and grow without attachment
- Untreated surfaces are ideal for adding coatings in your lab
- Cell Culture Treated: The Thermo Scientific™ Nunclon™ Delta cell culture treated surface is a hydrophilic surface that promotes cell attachment and growth
- Optical clarity makes colonies easy to see

Nunc OmniTray acts as:

- Holder for membrane when dot blotting; container for hybridization and washing steps; storage container for membranes

Recommended for: Dot blotting, denaturation/hybridization/washing, bacterial growth, membrane storage and microplate inoculation when used with TSP lid.

Compliance: All Nunc microplates meet the recommendation of American National Standards Institute (ANSI).

Nunc OmniTray

| Cat. No. | Surface | Well Design | Color | Total Vol., μ L | Working Vol., mL | Sterile | Lid | No. per Pack | No. per Case |
|----------|--------------|-------------|-------|---------------------|------------------|---------|-----|--------------|--------------|
| 140156* | Cell Culture | Rectangular | Clear | 90 | 35 | Yes | Yes | 10 | 90 |
| 165218 | Cell Culture | Rectangular | Clear | 90 | 35 | Yes | Yes | 10 | 60 |
| 242811 | Non-Treated | Rectangular | Clear | 90 | 35 | Yes | Yes | 10 | 60 |
| 264728 | Non-Treated | Rectangular | Clear | 90 | 35 | Yes | Yes | 10 | 90 |

* Enhanced rectangular area ideal for automated picking and viewing system



Thermo Scientific Nunc Immuno TSP

Thermo Scientific™ Nunc™ Immuno™ TSP lid is ideal for Hybridoma screening.

- Ideal for screening of hybridoma cultures for antibody production
- For Hybridoma screening mounted in the OmniTray
- Uniform adsorption properties
- 96 Pin lid for bacterial inoculations of 96-well plates

Nunc-Immuno TSP

| Cat No | Surface | Color | Total surface area, mm ² | Sterile | Lid | No. per Pack | No. per Case |
|--------|-------------|-------|-------------------------------------|---------|-----|--------------|--------------|
| 445497 | Non-treated | Clear | 95 | Yes | No | 1 | 50 |

Thermo Scientific Nunc Multidishes

Cell Culture Treated



Nunc Cell Culture Multidishes are Thermo Scientific™ Nunclon™ Delta treated.

This proprietary surface modification promotes maximum adhesion for a broad range of cell types and ensures optimum performance.

details

- Flat well bottom and stackable
- Raised well rims lower risk of cross contamination
- Excellent optical quality
- Alphanumeric codes for well identification
- Sterilized and certified to be non-pyrogenic

Round Well Styles

- Feature vented lids for gas exchange
- Recessed areas around wells act as a reservoir to reduce evaporation from wells
- Lids with notched corners allow for easy orientation and reduce cross contamination

Rectangular Well Styles

- Large culture area
- Accepts standard glass cover slips: 24 × 60 mm for 4-well plate; and 22 × 22 mm for 8-well plate

Certifications: Offered with certificate of traceability and quality (one certificate per case).

Nunc Multidishes

| Cat. No. | Surface Culture | No of Wells | O.D., mm | Well Shape | Culture Area, cm ² | Working Vol., mL | No. per Pack | No. per Case |
|----------|-----------------|-------------|----------|-------------|-------------------------------|------------------|--------------|--------------|
| 176740 | Nunclon Delta | 4 | 66 x 66 | Round | 1.9 | 1 | 4 | 120 |
| 167063 | Nunclon Delta | 4 | 128 x 86 | Rectangular | 21.8 | 5 | 10 | 100 |
| 140675 | Nunclon Delta | 6 | 128 x 86 | Round | 9.6 | 3 | 1 | 75 |
| 140685 | Nunclon Delta | 6 | 128 x 86 | Round | 9.6 | 3 | 5 | 85 |
| 167064 | Nunclon Delta | 8 | 128 x 86 | Rectangular | 10.5 | 3 | 10 | 100 |
| 150628 | Nunclon Delta | 12 | 128 x 86 | Round | 3.5 | 2 | 1 | 75 |
| 142475 | Nunclon Delta | 24 | 128 x 86 | Round | 1.8 | 1 | 1 | 75 |
| 142485 | Nunclon Delta | 24 | 128 x 86 | Round | 1.8 | 1 | 5 | 85 |
| 150687 | Nunclon Delta | 48 | 128 x 86 | Round | 1.1 | 0.5 | 1 | 75 |
| 152640 | Nunclon Delta | 48 | 128 x 86 | Round | 1.1 | 0.5 | 5 | 85 |

► To request certificates online, visit www.thermoscientific.com/certificates

Thermo Scientific Nunc Multidishes and Microplates

Nunclon™ Sphera™ Surface



Make your most valuable work your best work. Thermo Scientific™ Nunclon™ Sphera™ Microplates feature a superior cell culture surface with demonstrated performance that elevates stem cell and cell culture research. Offered in round and flat-bottom 96-well formats.

details

Optimizes spheroid formation

- Allows cells to grow in suspension with virtually no cell attachment
- Supports many different cell types and their ability to generate spheroids
- Enables consistent, repeatable cell growth

Ideal for growing 3D cancer cultures

- Minimizes variability and supports the consistent formation of cancer spheroids that simulate the 3D structures of tumor growth, providing a better model system for studying tumor cell progression and efficacy of anticancer agents *in vitro*

Promotes formation of embryoid bodies (EB)

- Demonstrates superior quality for embryoid body formation of pluripotent stem cells with minimal spontaneous differentiation
- Resultant cells able to differentiate into all three germ layers

Nunc Multidishes

| Cat. No. | Surface | Well Design | Color | Culture Area, cm ² | Sterile | Lid | No. per Pack | No. per Case |
|----------|---------|-------------|-------|-------------------------------|---------|-----|--------------|--------------|
| 174932 | Sphera | 6 F | Clear | 9.6 | Yes | Yes | 1 | 7 |
| 174931 | Sphera | 12 F | Clear | 3.5 | Yes | Yes | 1 | 7 |
| 174930 | Sphera | 24 F | Clear | 1.9 | Yes | Yes | 1 | 7 |
| 174925 | Sphera | 96 U | Clear | 0.36 | Yes | Yes | 1 | 8 |
| 174927 | Sphera | 96 F | Clear | 0.33 | Yes | Yes | 1 | 8 |
| 174929 | Sphera | 96 U | Clear | 0.36 | Yes | Yes | 5 | 50 |

Thermo Scientific Nunc Multidishes UpCell Surface



Nunc Multidishes with Thermo Scientific™ UpCell™ Surface feature a temperature-responsive surface that supports non-enzymatic harvesting of adherent cells for preservation of cell viability and surface proteins.

Simply transfer the culture to room temperature and cells can be collected in suspension or in the form of a “cell sheet”.

Traditional cell harvesting by enzymatic and mechanical methods often compromise the integrity of surface proteins and the viability of harvested cells. By contrast, the UpCell Surface allows cell harvesting by simply reducing the temperature of the cell culture to below 32°C without the need of enzymes, resulting in highly viable cells with intact cell surface proteins.

details

- No trypsinization – preserve cell surface proteins
- No physical force – get high cell viability
- Perfect for culture passaging, single-cell analyses and cell transplantation research
- 6-well multidish comes with supportive membranes that enable harvesting of cell sheets and creations of 3-D tissue models
- Minimal manual manipulation

Recommended for: Culture passaging, single-cell analyses, cell transplantation research, 3D tissue models.

Nunc Multidishes

| Cat. No. | Well Design | Supportive membrane (for harvesting “cell sheet”) | Color | Membrane | Culture Area, cm ² | Suggested Working Vol., mL | Sterile | Lid | No. per Pack | No. per Case |
|----------|-------------|---|-------|----------|-------------------------------|----------------------------|---------|-----|--------------|--------------|
| 174901 | 6 F | Included | Clear | Yes | 9.6 | 3 | Yes | Yes | 1 | 6 |
| 174900 | 12 F | Not Included | Clear | No | 3.5 | 2 | Yes | Yes | 1 | 6 |
| 174899 | 24 F | Not Included | Clear | No | 1.9 | 1 | Yes | Yes | 1 | 6 |
| 174898 | 48 F | Not Included | Clear | No | 1.1 | 0.5 | Yes | Yes | 1 | 6 |
| 174897 | 96 F | Not Included | Clear | No | 0.33 | 0.2 | Yes | Yes | 1 | 8 |

Thermo Scientific Nunc Multidishes
Poly-D-Lysine or Collagen I Coated



Nunc Multidishes with extracellular matrix coating enhance cell attachment to the culture surface. Ideal for culturing finicky cells.

details

- Ideal for culturing finicky cells that do not attach to regular cell culture treated surface
- Poly-D-Lysine is a chemically synthesized animal-free coating material
- Sterile and non-pyrogenic

Nunc Multidishes

| Cat. No. | Surface Coating | Working Vol., mL | Culture Area, cm ² | No. of Wells | No. per Pack | No. per Case |
|----------|----------------------|------------------|-------------------------------|--------------|--------------|--------------|
| 152035 | Poly-D-Lysine coated | 3 | 9.6 | 6 | 5 | 20 |
| 152034 | Collagen I, rat tail | 3 | 9.6 | 6 | 5 | 20 |

Thermo Scientific Nunc Multidish 6 Nunclon Vita



Thermo Scientific™ Nunclon™ Vita™ is a unique energy-treated surface that enables growth of stem cells and other temperamental cells without matrix coatings or feeder layers.

When combined with conditioned media, supplemented with a ROCK inhibitor, Nunclon Vita surface supports attachment and expansion of human pluripotent stem cells.

Nunclon Vita surface supports attachment and growth of finicky cells (e.g. HEK 293, MSC) in the absence of feeder layers and matrix coatings. In conditioned media, supplemented with ROCK inhibitor, human ESC can be cultured directly on the Nunclon Vita surface for more than 10 passages while maintaining normal karyotype and pluripotency.

details

- Animal component-free surface
- Consistent performance from lot to lot
- Supports attachment and growth of temperamental cells (e.g. HEK 293, MSC)
- Supports attachment and expansion of human pluripotent stem cells in conditioned media containing ROCK inhibitor
- Allows non-enzymatic dissociation of human pluripotent stem cells with removal of ROCK inhibitor

Nunc Multidish 6

| Cat. No. | Description | Working Vol., mL | Culture Area, cm ² /well | No. of Wells | Bottom Shape | Sterile | No. per Pack | No. per Case |
|----------|--------------------------|------------------|-------------------------------------|--------------|--------------|---------|--------------|--------------|
| 145380 | Nunclon Vita Multidish 6 | 3 | 9.6 | 6 | Flat | Yes | 1 | 4 |

Thermo Scientific Biolite Cell Culture Products



Thermo Scientific™ BioLite™ Cell Culture Products deliver economical performance for your general cell culture procedures.

BioLite Cell Culture products are designed for your general cell culture research, an ideal choice when economy and quality matter.

This product line includes a limited range of sterile flasks covering surface areas from 25 cm² to 175 cm²; dishes from 35 mm to 150 mm, and 6- to 96-well dishes.

BioLite products offer a cell-adherent surface and are non-pyrogenic and non-cytotoxic.

details

- Cell culture treated
- Sterile
- Non-pyrogenic
- USP Class VI and non-cytotoxic

Biolite Multidishes and Microwell Plate

| Cat. No. | Well Design | Well Dia., mm | Outer L x W mm | Color | Culture Area, cm ² /well | Suggested Working Vol., mL | Lid | Sterile | No. per Pack | No. per Case |
|----------|-------------|---------------|----------------|-------|-------------------------------------|----------------------------|-----|---------|--------------|--------------|
| 130184 | 6 | 35 | 127.6 x 85.4 | Clear | 9.6 | 3 | Yes | Yes | 1 | 50 |
| 130185 | 12 | 22.1 | 127.6 x 85.4 | Clear | 3.8 | 2 | Yes | Yes | 1 | 50 |
| 130186 | 24 | 15.6 | 127.6 x 85.4 | Clear | 1.9 | 1 | Yes | Yes | 1 | 50 |
| 130187 | 48 | 9.75 | 127.6 x 85.4 | Clear | 0.75 | 0.5 | Yes | Yes | 1 | 50 |
| 130188 | 96F | 6.4 | 127.6 x 85.4 | Clear | 0.32 | 0.2 | Yes | Yes | 1 | 50 |

Thermo Scientific Nunc Multidishes

Non-treated



Nunc Multidishes are non-treated and sterile for suspension of cell cultures and have excellent optical properties.

details

- Non-treated, sterile polystyrene multidishes for suspension cell culture
- Flat-bottom round wells, with lid
- Raised-well rims lower the risk of cross-contamination
- Lid with notched corners for good fit and easy orientation
- Non-pyrogenic

Includes: Lids

Nunc Multidishes

| Cat. No. | No. of Wells | Culture Area cm ² | Working Vol., mL | O.D., L x W, mm | No. per Pack | No. per Case |
|----------|--------------|------------------------------|------------------|-----------------|--------------|--------------|
| 179820 | 4 | 1.9 | 1 | 66 x 66 | 4 | 120 |
| 150239 | 6 | 9.6 | 3 | 128 x 86 | 1 | 75 |
| 150200 | 12 | 3.5 | 2 | 128 x 86 | 1 | 75 |
| 144530 | 24 | 1.9 | 1 | 128 x 86 | 1 | 75 |
| 150787 | 48 | 1.1 | 0.5 | 128 x 86 | 1 | 75 |

INNOVATIVE DESIGN MINIMIZES EVAPORATION

Protect Your Cells Against “Edge Effect”

Thermo Scientific Nunc Edge 96-Well Plates

Few options exist to minimize evaporation during extended culturing, which often most affects cells at the plate's outer edge. One common method is to leave perimeter wells unused – but that sacrifices almost 40% of the entire plate capacity.

Thermo Scientific™ Nunc™ Edge Plates have a built-in moat surrounding the perimeter wells that provides extra humidity and reduces evaporation from the entire plate.

▶ To learn more about the advantages of Nunc Edge Plates, visit www.thermoscientific.com/edgeplate

In a comparison to standard plates, Nunc Edge plates significantly reduced evaporation during 7-day and 14-day incubation trials:

STANDARD PLATE/7-DAY TRIAL

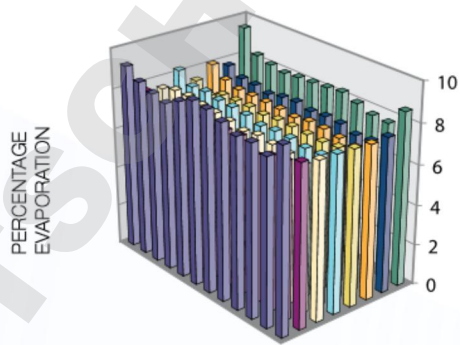

NUNC EDGE PLATE/7-DAY TRIAL



14-DAY COMPARISON



Thermo Scientific Nunc Edge 96-Well Plate

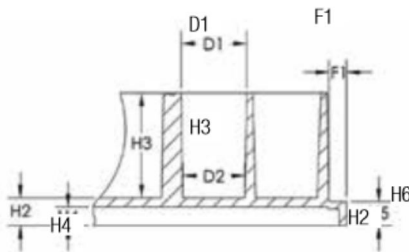
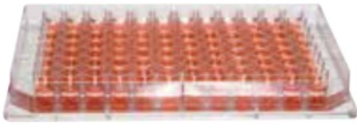

| | mm |
|---|-------------|
| Total height of plate | 14.4 |
| H2 Vertical distance from inside well bottom to resting plane | 3.0 |
| H3 Inside depth of well | 11.4 |
| H4 Vertical distance from external well bottom to resting plane | 2.0 |
| H5 Height of flange on the short side | 2.6 |
| D1 Well diameter, top | 7.1 |
| D2 Well diameter, bottom | 6.7 |
| F1 Depth of flange | 1.9 |



The Thermo Scientific™ Nunc™ Edge™ 96-Well Plate has a unique design that minimizes plate evaporation.

Fill each moat section with 1.7 mL sterile water or media; the large evaporation reservoirs eliminate well-to-well variability while dramatically reducing the overall evaporation rate to <2% after 7 days of incubation. In addition to the evaporation barrier, the Edge plate is engineered for optical superiority allowing your automated imaging systems to operate efficiently.

details

- Clear polystyrene has excellent optical properties making it ideal for optical measurements
- Untreated polystyrene is hydrophobic and is suited for growth of suspension cultures that can proliferate and grow without attachment.
- Untreated surfaces are ideal for adding coatings in your lab
- Cell Culture Treated: The Nunclon Delta cell culture treated surface is a hydrophilic surface that promotes cell attachment and growth
- Customized bar coding is available
- Working volume: 50-250 μL /well
- Total well volume: 400 μL

Reduced Edge Effect

- Virtually eliminates evaporation in lengthy incubations
- Use all 96 wells with fewer concerns of edge effect

Low Evaporation Permits Full-plate Results

- Unique design minimizes plate evaporation
- Large evaporative buffer zones eliminate well-to-well variability
- Overall plate evaporation rate reduced to <2% after seven days of incubation
- Perimeter moat can be filled with 1.7 mL sterile H_2O or media

Optical Properties are Critical

- Clear plates are engineered for optical superiority
- Low background fluorescence
- Extreme well flatness
- Ideal for image-based high content applications like measuring primary neuron cultures

Compliance: All Nunc microplates meet the recommendation of American National Standards Institute (ANSI).

Nunc Edge 96-Well Plate

| Cat. No. | Surface | Well Design | Color | Total Vol., μL | Sterile | Lid | No. per Pack | No. per Case |
|----------|--------------|-------------|-------|---------------------------|---------|-----|--------------|--------------|
| 167311 | Cell Culture | 96 F | Clear | 400 | Yes | No | 10 | 160 |
| 167314 | Cell Culture | 96 F | Clear | 400 | Yes | Yes | 1 | 50 |
| 267312 | Non-treated | 96 F | Clear | 400 | No | Yes | 10 | 160 |
| 267313 | Non-treated | 96 F | Clear | 400 | Yes | Yes | 1 | 50 |

Thermo Scientific Flat Bottom 96-well Clear Polystyrene Plates



Flat bottom 96-well Polystyrene Plates are optimized for robotics, automated readers and liquid handling systems.

Clear 96-well microplates are used for cell-based, binding and colorimetric assays. The flat bottom is ideal for microscopic and optical measurements. Our plates are high quality for consistent and reliable results

details

- Clear polystyrene has excellent optical properties making it ideal for optical measurements
- Untreated polystyrene is hydrophobic and is suited for growth of suspension cultures that can proliferate and grow without attachment
- Untreated surfaces are ideal for adding coatings in your lab
- Cell Culture Treated: The Nunclon Delta cell culture treated surface is a hydrophilic surface that promotes cell attachment and growth
- Plates are optimized for robotics, plate readers and liquid handlers
- Working volume: 50-250 μL /well

Compliance: All Thermo Scientific microplates meet the recommendation of American National Standards Institute (ANSI).

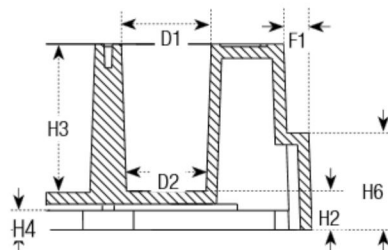

| | mm |
|---|-------------------|
| Total height of plate | 14.4 ± 0.2 |
| H2 Vertical distance from inside well bottom to resting plane | 3.0 |
| H3 Inside depth of well | 11.4 |
| H4 Vertical distance from external well bottom to resting plane | 1.9 |
| H5 Height of flange on the short side | 2.4 |
| H6 Height of flange on the long side | 7.4 |
| D1 Well diameter, top | 7.0 |
| D2 Well diameter, bottom | 6.2 |
| F1 Depth of flange | 1.7 |

Flat Bottom 96-well Clear Polystyrene Plates

| Cat. No. | Surface | Well Design | Color | Total Vol., μ L | Sterile | Lid | No. Per Pack | No. Per Case |
|-----------|----------------------------|------------------|-------|---------------------|---------|-----|--------------|--------------|
| 152038 | Collagen I | 96 F | Clear | 400 | --* | Yes | 5 | 20 |
| 152039 | Poly-D-Lysine | 96 F | Clear | 400 | --* | Yes | 5 | 20 |
| 156545** | Cell Culture | 96 F | Clear | 400 | Yes | Nb | 10 | 180 |
| 161093** | Cell Culture | 96 F | Clear | 400 | Yes | Yes | 10 | 160 |
| 167008** | Cell Culture | 96 F | Clear | 400 | Yes | Yes | 1 | 50 |
| 168055** | Cell Culture | 96 F | Clear | 400 | Yes | Nb | 1 | 50 |
| 174897 | LpCell | 96 F | Clear | 400 | Yes | Yes | 1 | 8 |
| 174927 | Sphera | 96 F | Clear | 400 | Yes | Yes | 1 | 8 |
| 243656 | Non-Treated | 96 F | Clear | 400 | Yes | Yes | 6 | 108 |
| 260836 | Non-Treated | 96 F | Clear | 400 | Nb | Nb | 10 | 180 |
| 260844* | Non-Treated | 96 F | Clear | 400 | Nb | Nb | 10 | 180 |
| 260860 | Non-Treated | 96 F | Clear | 400 | Yes | Yes | 10 | 160 |
| 260887* | Non-Treated | 96 F | Clear | 400 | Yes | Yes | 10 | 160 |
| 260895 | Non-Treated | 96 F | Clear | 400 | Nb | Yes | 10 | 160 |
| 266120 | Non-Treated | 96 F | Clear | 400 | Yes | Yes | 25 | 100 |
| 269620 | Non-Treated | 96 F | Clear | 400 | Nb | Nb | 5 | 60 |
| 269787 | Non-Treated | 96 F | Clear | 400 | Yes | Nb | 1 | 50 |
| 9205 | Non-Treated | 96 F-Square Well | Clear | 330 | Nb | Nb | 50 | 50 |
| 3355 | Immulon 1 B | 96 F | Clear | 330 | Nb | Nb | 10 | 50 |
| 3455 | Immulon 2 HB | 96 F | Clear | 330 | Nb | Nb | 10 | 50 |
| 3855** | Immulon 4 HBX | 96 F | Clear | 330 | Nb | Nb | 10 | 50 |
| 436006 | Immobilizer Amino | 96 F | Clear | 400 | Nb | Nb | 5 | 30 |
| 436014 | Immobilizer Streptavidin | 96 F | Clear | 400 | Nb | Nb | 1 | 15 |
| 436024 | Immobilizer Nickel-Chelate | 96 F | Clear | 400 | Nb | Nb | 1 | 15 |
| 436032 | Immobilizer Gultathione | 96 F | Clear | 400 | Nb | Nb | 1 | 15 |
| 439454** | MaxiSorp | 96 F | Clear | 400 | Nb | Nb | 5 | 60 |
| 442404 | MaxiSorp | 96 F | Clear | 400 | Nb | Nb | 5 | 60 |
| 456529 | PolySorp | 96 F | Clear | 400 | Nb | Nb | 10 | 180 |
| 456537** | MaxiSorp | 96 F | Clear | 400 | Nb | Nb | 10 | 180 |
| 460984/** | MaxiSorp | 96 F | Clear | 400 | Nb | Nb | 10 | 180 |
| 467320 | MediSorp | 96 F | Clear | 400 | Nb | Nb | 5 | 60 |
| 467340 | MultiSorp | 96 F | Clear | 400 | Nb | Nb | 5 | 60 |
| 475094 | PolySorp | 96 F | Clear | 400 | Nb | Nb | 5 | 60 |
| 9502227 | Universal Binding | 96 F | Clear | 450 | Nb | Nb | 25 | 50 |
| 95029330 | Enhanced Binding | 96 F | Clear | 450 | Nb | Nb | 25 | 50 |
| 95029780 | Universal Binding | 96 F | Clear | 450 | Yes | Yes | 1 | 40 |

* Produced in a clean environment + Barcoded, 7-digit Code, 39 alphanumeric label, short left side ** Certified

u For custom barcoded plates, visit
www.thermoscientific.com/barcodeconfigurator

Thermo Scientific Flat Bottom 96-well Black and White Polystyrene Plates



Flat-bottom 96-well Black and White Polystyrene Plates are optimized for robotics, plate readers and liquid handling systems.

Our plates are high quality for consistent and reliable results.

details

- Background, autofluorescence and crosstalk are reduced when you use Nunc Black or White microplates
- Black microplates are recommended for fluorescence measurements with minimum back-scattered light and background fluorescence
- White microplates are recommended for luminescence measurements with maximum reflection and minimal autoluminescence
- Cell Culture Treated: The Nunclon Delta Cell Culture treated surface is a hydrophilic surface that promotes cell attachment and growth
- Working volume range: 50 to 250 μL /well

Compliance: All Thermo Scientific microplates meet the recommendation of American National Standards Institute (ANSI), (ANSI/SBS 1-2004).

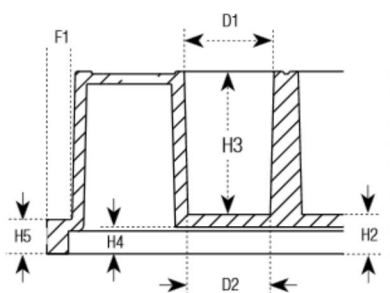

| | mm |
|---|-------------------|
| Total height of plate | 14.5 ± 0.3 |
| H2 Vertical distance from inside well bottom to resting plane | 3.6 |
| H3 Inside depth of well | 11.2 |
| H4 Vertical distance from external well bottom to resting plane | 2.1 |
| H5 Height of flange | 2.7 |
| D1 Well diameter, top | 7.05 |
| D2 Well diameter, bottom | 6.55 ± -0.1 |
| F1 Depth of flange | 2.0 |

Flat Bottom 96-well Black and White Polystyrene Plates

| Cat. No. | Surface | Well Design | Color | Total Vol., μL | Sterile | Lid | No. per Pack | No. Per Case |
|----------|--------------|-------------|-------|---------------------------|---------|-----|--------------|--------------|
| 136101** | Cell Culture | 96 F | White | 400 | Yes | Yes | 1 | 50 |
| 136102** | Cell Culture | 96 F | White | 400 | Yes | Yes | 10 | 160 |
| 137101** | Cell Culture | 96 F | Black | 400 | Yes | Yes | 1 | 50 |
| 137103** | Cell Culture | 96 F | Black | 400 | Yes | Yes | 10 | 160 |
| 236105 | Non-Treated | 96 F | White | 400 | Yes | Yes | 1 | 50 |
| 236107 | Non-Treated | 96 F | White | 400 | Yes | Yes | 10 | 160 |
| 236108 | Non-Treated | 96 F | White | 400 | No | No | 10 | 180 |
| 237105 | Non-Treated | 96 F | Black | 400 | Yes | Yes | 1 | 50 |
| 237107 | Non-Treated | 96 F | Black | 400 | Yes | Yes | 10 | 160 |
| 237108 | Non-Treated | 96 F | Black | 400 | No | No | 10 | 180 |

** Certified

| Cat. No. | Surface | Well Design | Color | Total volume, μL/well | Sterile | Lid | No. per Pack | No. per Case |
|----------|----------------------------|-------------|-------|--------------------------|---------|-----|--------------|--------------|
| 436007 | Immobilizer Amino | 96 F | White | 400 | Nb | Nb | 5 | 30 |
| 436008 | Immobilizer Amino | 96 F | Black | 400 | Nb | Nb | 5 | 30 |
| 436015 | Immobilizer Streptavidin | 96 F | White | 400 | Nb | Nb | 1 | 15 |
| 436016 | Immobilizer Streptavidin | 96 F | Black | 400 | Nb | Nb | 1 | 15 |
| 436027 | Immobilizer Nickel-Chelate | 96 F | Black | 400 | Nb | Nb | 1 | 15 |
| 436033 | Immobilizer Gutathione | 96 F | White | 400 | Nb | Nb | 1 | 15 |
| 436034 | Immobilizer Gutathione | 96 F | Black | 400 | Nb | Nb | 1 | 15 |
| 436110 | MaxiSorp | 96 F | White | 400 | Nb | Nb | 10 | 80 |
| 436111 | PolySorp | 96 F | White | 400 | Nb | Nb | 10 | 80 |
| 437111 | MaxiSorp | 96 F | Black | 400 | Nb | Nb | 10 | 80 |
| 437112 | PolySorp | 96 F | Black | 400 | Nb | Nb | 10 | 80 |
| 7571 | Microtite 1+ | 96 F | White | 330 | Nb | Nb | 10 | 50 |
| 7572 | Microtite 2+ | 96 F | White | 330 | Nb | Nb | 10 | 50 |
| 7417-12 | Microtite 2+ | 96 F | White | 330 | Nb | Nb | 50 | 50 |
| 7605 | Microfluor 1 | 96 F | Black | 330 | Nb | Nb | 10 | 50 |
| 7705 | Microfluor 1 | 96 F | White | 330 | Nb | Nb | 10 | 50 |
| 7805 | Microfluor 2 | 96 F | Black | 330 | Nb | Nb | 10 | 50 |
| 7905 | Microfluor 2 | 96 F | White | 330 | Nb | Nb | 10 | 50 |
| 9502867 | Universal Binding | 96 F | Black | 450 | Nb | Nb | 25 | 50 |
| 9502887 | Universal Binding | 96 F | White | 450 | Nb | Nb | 25 | 50 |

To request certificates online, visit
www.thermoscientific.com/certificates

Thermo Scientific Round Bottom 96-well Polystyrene Plates



Round Bottom (U) 96-well Polystyrene Plates are optimized for robotics, automated readers and liquid handling systems.

96-well round (U) bottom microplates are ideal for agglutination assays.

details

- Clear polystyrene has excellent optical properties making it ideal for optical measurements
- Untreated polystyrene is hydrophobic and is suited for growth of suspension cultures that can proliferate and grow without attachment
- Untreated surfaces are ideal for adding coatings in your lab
- Cell Culture Treated: The Nunclon Delta cell culture treated surface is a hydrophilic surface that promotes cell attachment and growth
- Plates are optimized for robotics, plate readers and liquid handlers
- Working volume: 50 to 250 μL /well

Compliance: All Thermo Scientific microplates meet the recommendation of American National Standards Institute (ANSI).

| | mm |
|---|----------------------------------|
| Total height of plate | 14.5 \pm 0.1 |
| H2 Vertical distance from inside well bottom to resting plane | 4.2 |
| H3 Inside depth of well | 10.2 |
| H4 Vertical distance from external well bottom to resting plane | 2.8 |
| H5 Height of flange on the short side | 2.4 |
| H6 Height of flange on the long side | 7.5 |
| D1 Well diameter, top | 7.1 |
| D2 Well diameter, bottom | Round bottom |
| F1 Depth of flange | 1.7 |

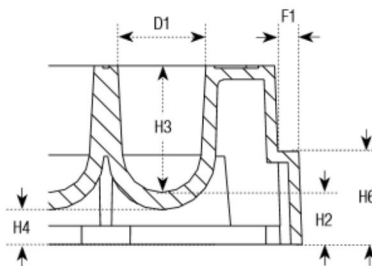

Round Bottom 96-well Polystyrene Plates

| Cat. No. | Surface | Well Design | Color | Total Vol. μ L/well | Sterile | Lid | Nb. per Pack | Nb. per Case |
|----------|--------------|------------------|-------|-------------------------|---------|-----|--------------|--------------|
| 3555 | Immulon 1 B | 96 U | Clear | 280 | Nb | Nb | 10 | 50 |
| 3655 | Immulon 2 HB | 96 U | Clear | 280 | Nb | Nb | 10 | 50 |
| 449824 | MaxiSorp | 96 U | Clear | 300 | Nb | Nb | 5 | 60 |
| 475434 | PolySorp | 96 U | Clear | 300 | Nb | Nb | 5 | 60 |
| 143761** | Cell Culture | 96 U | Clear | 300 | Yes | Nb | 1 | 50 |
| 163320 | Cell Culture | 96 U | Clear | 300 | Yes | Yes | 1 | 50 |
| 168136** | Cell Culture | 96 U | Clear | 300 | Yes | Yes | 10 | 160 |
| 174925 | Sphera | 96 U | Clear | 300 | Yes | Yes | 1 | 8 |
| 262146 | Non-Treated | 96 U | Clear | 300 | Nb | Nb | 135 | 135 |
| 262162 | Non-Treated | 96 U | Clear | 300 | Yes | Nb | 1 | 50 |
| 268152 | Non-Treated | 96 U | Clear | 300 | Nb | Nb | 10 | 180 |
| 268200 | Non-Treated | 96 U | Clear | 300 | Yes | Yes | 10 | 160 |
| 2205 | Non-Treated | 96 U-Square Well | Clear | 400 | Nb | Nb | 50 | 50 |
| 174929 | Sphera | 96 U | Clear | 300 | Yes | Yes | 5 | 50 |

**Certified



Thermo Scientific Conical Bottom 96-well Polystyrene Plates



Nunc V96 Well Clear Polystyrene Microplates are optimized for robotics, automated readers and liquid handling systems.

Conical bottom (V) 96-well microplates are ideal for sample recovery. Applications include: antibiotic screens, serological tests, storing, screening compounds and DNA libraries

details

- Clear polystyrene has excellent optical properties making it ideal for optical measurements
- Plates are optimized for robotics, plate readers and liquid handlers
- Customized bar coding is available
- Working volume range: 50 to 250 μL /well

Compliance: All Thermo Scientific microplates meet the recommendation of American National Standards (ANSI).



| | mm |
|---|----------------------------------|
| Total height of plate | 14.4 \pm 0.1 |
| H2 Vertical distance from inside well bottom to resting plane | 4.6 |
| H3 Inside depth of well | 9.8 |
| H4 Vertical distance from external well bottom to resting plane | 2.8 |
| H5 Height of flange | 2.7 |
| D1 Well diameter, top | 6.8 |
| D2 Well diameter, bottom | V-shaped |
| F1 Depth of flange | 1.2 |

Conical Bottom 96-well Polystyrene Plates

| Cat. No. | Surface | Well Design | Color | Total Vol., μL | Sterile | Lid | No. per Pack | No. per Case |
|----------|-------------|------------------|-------|---------------------------|---------|-----|--------------|--------------|
| 249570 | Non-Treated | 96 V | Clear | 300 | No | No | 10 | 180 |
| 249662 | Non-Treated | 96 V | Clear | 300 | Yes | No | 1 | 50 |
| 249935 | Non-Treated | 96 V | Clear | 300 | Yes | Yes | 10 | 80 |
| 249940 | Non-Treated | 96 V | Clear | 300 | Yes | No | 10 | 80 |
| 249952 | Non-Treated | 96 V | Clear | 300 | Yes | Yes | 10 | 160 |
| 277143* | Non-Treated | 96 V | Clear | 300 | Yes | Yes | 1 | 50 |
| 2605 | Non-Treated | 96 V-Square Well | Clear | 280 | No | No | 50 | 50 |

* Not available in the Americas

► For custom barcoded plates, visit
www.thermoscientific.com/barcodeconfigurator

Thermo Scientific 96-well UV Plates



UV-transparent 96-well microplates are ideal for DNA and protein quantitation in the 260 nm and 280 nm range.

The 96-well format allows a higher throughput of sample screening compared to cuvettes.

details

- Certified RNase and DNase free; non-pyrogenic
- Low background absorbance
- Measure protein concentrations at 280 nm
- Temperature range: -80°C to +40°C
- Working volume: 25 to 340 μL /well

Compliance: This Thermo Scientific microplate meets the recommendation of American National Standards Institute (ANSI).

96-Well UV Plates

| Cat. No. | Surface | Well Design | Color | Total Vol., μL | Sterile | Lid | No. per Pack | No. per Case |
|----------|---------|-------------|-------|---------------------------|---------|-----|--------------|--------------|
| 8404 | UV | 96 F | Clear | 392 | No | No | 10 | 40 |

Thermo Scientific Nunc C96-Well Clear Polystyrene Microplates



Nunc C96-well Polystyrene Plates offer the advantage of a flat-bottom well with the optimal washing of a U bottom plate.

The 96-well format allows a higher throughput of sample screening compared to cuvettes.

details

- Clear polystyrene has excellent optical properties making it ideal for optical measurements
- Plates are optimized for robotics, plate readers and liquid handlers
- Customized bar coding is available
- Working volume range: 50 to 250 μL /well

Compliance: All Nunc microplates meet the recommendation of American National Standards (ANSI).

| | mm |
|------------------------------|----------------------------------|
| Total height of plate | 14.4 \pm 0.1 |
| M Bottom of Well Distance | 3.4 |
| L Depth of Well | 11 |
| G1 Well diameter, top | 06.6 |
| G2 Well diameter, bottom | 06.1 |
| N Flange Short side | 2.7 |

Nunc C96-Well Clear/White Polystyrene Microplates

| Cat. No. | Surface | Well Design | Color | Total Vol., μL | Sterile | Lid | No. per Pack | No. per Case |
|----------|-------------------------------|-------------|-------|---------------------------|---------|-----|--------------|--------------|
| 236001 | Passively Coated Streptavidin | 96 C | Clear | 350 | No | No | 1 | 15 |
| 430341 | MaxiSorp | 96 C | Clear | 350 | No | No | 5 | 60 |
| 437796** | MaxiSorp | 96 C | White | 350 | No | No | 5 | 60 |
| 446140 | PolySorp | 96 C | Clear | 350 | No | No | 5 | 60 |
| 446612** | MaxiSorp | 96 C | Clear | 350 | No | No | 5 | 60 |

**Certified

Thermo Scientific Nunc MicroWell 96-well Optical-Bottom Plates with Polymer Base



Thermo Scientific™ Nunc™ MicroWell™ 96-well Optical-Bottom Plates have an opaque polystyrene black or white upper structure with a polystyrene film on the bottom of the plate.

The plates are optimized for fluorescence and luminescence in cell culture and microscopic applications.

White or black polystyrene upper structure with polymer bottom plates combine the optical clarity of virgin crystalline polystyrene with optimal surface for a wide range of HTS applications.

details

- Black microplates are recommended for fluorescence measurements with minimum crosstalk and background fluorescence
- White microplates are recommended for luminescence measurements with maximum reflection and minimal autoluminescence
- Polymer base plate
- Working range, 50-200 µL/well
- Customized bar coding is available

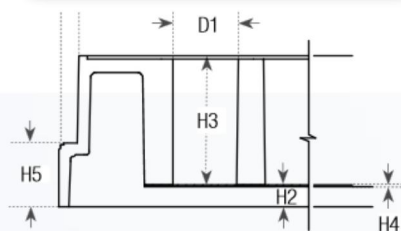

| | mm |
|---|-------------|
| Total height of plate | 14.9 |
| H2 Vertical distance from inside well bottom to resting plane | 2.2 |
| H3 Inside depth of well | 12.1 |
| H4 Polystyrene film | 0.25 |
| H5 Height of flange | 6.2 |
| D1 Well diameter | 6.5 |

Compliance: All Nunc microplates meet the recommendation of American National Standards Institute (ANSI).

Nunc MicroWell 96-Well Optical-Bottom Plates with Polymer Base

| Cat. No. | Surface | Well Design | Color | Bottom Plate | Total Vol., µL | Sterile | Lid | No. per Pack | No. per Case |
|----------|---------------|-------------|-------|--------------|----------------|---------|-----|--------------|--------------|
| 152028* | Poly-D-Lysine | 96 F | White | Polymer | 400 | --* | Yes | 5 | 20 |
| 152036* | Collagen I | 96 F | Black | Polymer | 400 | --* | Yes | 5 | 20 |
| 152037* | Poly-D-Lysine | 96 F | Black | Polymer | 400 | --* | Yes | 5 | 20 |
| 152040* | Collagen I | 96 F | White | Polymer | 400 | --* | Yes | 5 | 20 |
| 165305** | Cell Culture | 96 F | Black | Polymer | 400 | Yes | Yes | 10 | 30 |
| 165306** | Cell Culture | 96 F | White | Polymer | 400 | Yes | Yes | 10 | 30 |
| 265301 | Non-treated | 96 F | Black | Polymer | 400 | No | No | 10 | 30 |
| 265302 | Non-treated | 96 F | White | Polymer | 400 | No | No | 10 | 30 |

* Produced in a clean environment ** Certified

Thermo Scientific Nunc MicroWell 96-well Optical-Bottom Plates with Coverglass Base

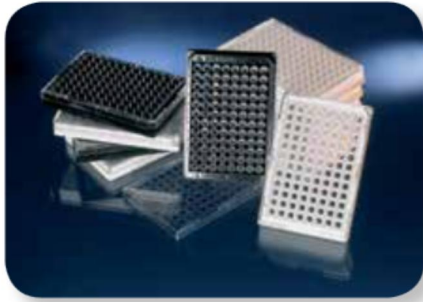

Nunc Optical Bottom Plates have an opaque polystyrene black or white upper structure with a coverglass plate bottom.

The plates are optimized for fluorescence and luminescence in cell culture and microscopic applications. The coverglass bottom has minimum light scatter and low autofluorescence, ensuring accurate results due to higher signal-to-noise ratio.

details

- Black microplates are recommended for fluorescence measurements; with minimum crosstalk and background fluorescence
- White microplates are recommended for luminescence measurements; with maximum reflection and minimal autoluminescence
- Culture area, 0.32 cm²
- Cell culture surface is ideal for cell-based assays
- CC² surface modification closely mimics Poly-D-Lysine and is superior for attachment and growth of fastidious cells

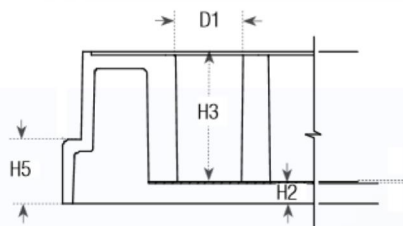

| | mm |
|---|-------------|
| Total height of plate | 14.9 |
| H2 Vertical distance from inside well bottom to resting plane | 2.2 |
| H3 Inside depth of well | 12.1 |
| H5 Height of flange | 6.2 |
| D1 Well diameter | 6.5 |

Compliance: All Nunc microplates meet the recommendation of American National Standards Institute (ANSI).

Nunc MicroWell 96-Well Optical-Bottom Plates with Coverglass Base

| Cat. No. | Surface | Well Design | Color | Bottom Plate | Sterile | Lid | No. per Pack | No. Per Case |
|----------|-----------------|-------------|-------|--------------------|---------|-----|--------------|--------------|
| 160376 | CC ² | 96 F | Black | No. 1.5 Coverglass | Yes | Yes | 6 | 30 |
| 164588 | Cell Culture | 96 F | Black | No. 1.5 Coverglass | Yes | Yes | 6 | 30 |
| 164590 | Cell Culture | 96 F | White | No. 1.5 Coverglass | Yes | Yes | 6 | 30 |
| 265300 | Non-treated | 96 F | Black | No. 1.5 Coverglass | No | No | 5 | 30 |

Thermo Scientific 96-well Polypropylene Plates



96-well Polypropylene Plates are the ideal storage plate. Polypropylene has low binding characteristics, allowing complete sample recovery.

Withstands temperatures from -80°C to $+121^{\circ}\text{C}$; available in a variety of colors for quick identification of your storage plates.

Nunc microplates have shared-wall technology, which increases well volume and widens cells to improve mixing.

details

- Wider wells and rounded bottom improve mixing
- Conical bottom wells for optimal sample recovery
- Excellent chemical resistance
- Black and white plates are available for fluorescent- and luminescent-based applications
- Low-binding for homogeneous assays and storage
- Ideal collection plate for Nunc Filter Plates
- U96-well plates – working volume range: 20 to 450 μL /well
- V96-well plates – working volume range: 10 to 400 μL /well
- Certified RNase/DNase-free

Compliance: All Thermo Scientific microplates meet the recommendation of the American National Standards Institute (ANSI).



| | mm |
|---|------------|
| Total height of plate | 14.5 ± 0.3 |
| H2 Vertical distance from inside well bottom to resting plane | 3.1 |
| HB Inside depth of well | 11.2 |
| H4 Vertical distance from external well bottom to resting plane | 2.0 |
| H5 Height of flange on the short side | 2.4 |
| D1 Well diameter, top | 8.5 |
| F1 Depth of flange | 1.7 |

| | mm |
|---|------------|
| Total height of plate | 14.4 ± 0.1 |
| H2 Vertical distance from inside well bottom to resting plane | 3.4 |
| HB Inside depth of well | 11.0 |
| H4 Vertical distance from external well bottom to resting plane | 2.5 |
| H5 Height of flange on the short side | 2.3 |
| H6 Height of flange on the long side | 7.5 |
| D1 Well diameter, top | 8.5 |
| D2 Well diameter, bottom | V-bottom |
| F1 Depth of flange | 1.7 |

96-Well Polypropylene MicroWell Plates

| Cat. No. | Surface | Well Design | Color | Total Vol., μL | Sterile | Lid | No. per Pack | Nb. per Case |
|----------|-------------|-------------|---------|---------------------------|---------|-----|--------------|--------------|
| 249943 | Non-Treated | 96 V | Red | 450 | Nb | Nb | 20 | 120 |
| 249944 | Non-Treated | 96 V | Natural | 450 | Nb | Nb | 20 | 120 |
| 249945 | Non-Treated | 96 V | Black | 450 | Nb | Nb | 20 | 120 |
| 249946 | Non-Treated | 96 V | Natural | 450 | Yes | Nb | 20 | 120 |
| 249947 | Non-Treated | 96 V | Yellow | 450 | Nb | Nb | 20 | 120 |
| 249949 | Non-Treated | 96 V | White | 450 | Nb | Nb | 20 | 120 |
| 249950 | Non-Treated | 96 V | Blue | 450 | Nb | Nb | 20 | 120 |
| 442587* | Non-Treated | 96 V | Natural | 300 | Nb | Nb | 5 | 60 |
| 267245 | Non-Treated | 96 U | Natural | 500 | Nb | Nb | 10 | 120 |
| 267334 | Non-Treated | 96 U | Natural | 500 | Yes | Nb | 10 | 120 |
| 267342 | Non-Treated | 96 U | Black | 500 | Nb | Nb | 10 | 120 |
| 267350 | Non-Treated | 96 U | White | 500 | Nb | Nb | 10 | 120 |
| 267369 | Non-Treated | 96 U | Red | 500 | Nb | Nb | 10 | 120 |
| 267385 | Non-Treated | 96 U | Blue | 500 | Nb | Nb | 10 | 120 |
| 267407 | Non-Treated | 96 U | Yellow | 500 | Nb | Nb | 10 | 120 |
| 95040410 | Non-Treated | 96 Square | Natural | 500 | Nb | Nb | 5 | 50 |

* Finch bar design; does not meet ANSI standard.

Thermo Scientific 96-DeepWell Polypropylene Plates



Nunc round-well plates



Square-well plates

DeepWell plates with shared-wall technology are ideal for sample collection, storage, combinatorial chemistry and library applications, and are resistant to most chemicals used in combinatorial chemistry.

Nunc shared-wall technology provides increased well volume optimizing storage capacity and improved mixing.

details

- Ideal as a collection plate for Nunc Filter Plates
- Storage plate for compounds, samples or biomolecules
- Optimized for bacterial and yeast growth
- Round-bottom wells reduce liquid retention
- Widely used for bacteria and yeast growth
- Resistant to most chemicals, solvents and alcohols used in combinatorial chemistry
- Certified RNase-free

Working volumes

- 1.0 mL polypropylene plates: 50-1000 μL /well
- 2.0 mL polypropylene plates: 50-2000 μL /well

Recommended for: Sample collection; storage; combinatorial chemistry; library applications; bacterial and yeast growth; collection plates for Nunc Filter Plates.

Compliance: All Thermo Scientific microplates meet the recommendation of American National Standards Institute (ANSI).

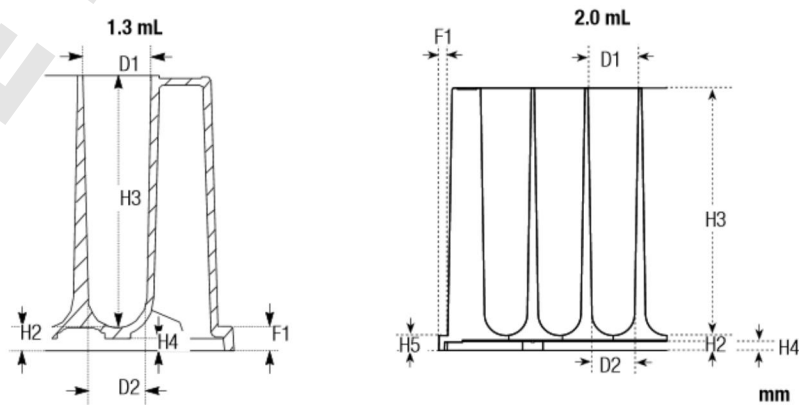

| | mm | | mm |
|---|-------------|---|-------------|
| Total height of plate | 31.6 | Total height of plate | 44.0 |
| H2 Vertical distance from inside well bottom to resting plane | 2.5 | H2 Vertical distance from inside well bottom to resting plane | 2.5 |
| H3 Inside depth of well | 29.1 | H3 Inside depth of well | 41.5 |
| H4 Vertical distance from external well bottom to resting plane | 1.4 | H4 Vertical distance from external well bottom to resting plane | 1.5 |
| D1 Well diameter, top | 8.5 | H5 Height of flange | 2.5 |
| D2 Well diameter, bottom | 8.4 | D1 Well diameter, top | 8.5 |
| F1 Depth of flange | 2.5 | D2 Well diameter, bottom | 6.0 |
| | | F1 Depth of flange | 1.5 |

1.3 and 2.0 mL DeepWell Plates

| Cat. No. | Surface | Well Design | Color | Total Vol., mL | Sterile | Lid | Nb. per Pack | Nb. per Case |
|----------|-------------|-------------|---------|----------------|---------|-----|--------------|--------------|
| 260251* | Non-treated | 96 U | Natural | 1.3 | Yes | No | 5 | 50 |
| 260252* | Non-treated | 96 U | Natural | 1.3 | No | No | 5 | 50 |
| 278743* | Non-treated | 96 U | Natural | 2.0 | Yes | No | 1 | 60 |
| 278752* | Non-treated | 96 U | Natural | 2.0 | No | No | 5 | 60 |
| 95040452 | Non-treated | 96 Square | Natural | 2 | No | No | 5 | 50 |
| 95040462 | Non-treated | 96 Square | Natural | 2 | Yes | No | 1 | 50 |

* Shared Well Technology

DeepWell Plates with Square Well Upper Structure

| Cat. No. | Surface | Well Design | Color | Total Vol., mL | Sterile | Lid | Nb. per Pack | Nb. per Case |
|----------|-------------|-------------|---------|----------------|---------|-----|--------------|--------------|
| 4211-11 | Non-treated | 96 U | Natural | 1.0 | No | No | 40 | 40 |
| 4212-11 | Non-treated | 96 U | Natural | 1.0 | Yes | No | 1 | 40 |
| 4221 | Non-treated | 96 U | Natural | 2.0 | No | No | 40 | 40 |
| 4222 | Non-treated | 96 U | Natural | 2.0 | Yes | No | 1 | 40 |

u Please see page 54 for Cap Mats



Thermo Scientific Nunc 96-DeepWell Polystyrene Plates



The untreated surface of Nunc 96-DeepWell Polystyrene Plates provides uniform surface properties, making them ideal for cloning and replication assays.

The round bottom is ideal for agglutination assays and sample collection.

details

- Optimized for robotics and liquid handling systems
- Round-bottom wells for optimal sample recovery
- Sealable with well caps and sealing tape
- Working range: 50 to 900 μL /well

Compliance: All Nunc microplates meet the recommendation of American National Standards Institute (ANSI).

Nunc 96-DeepWell Polystyrene Plates

| Cat. No. | Surface | Well Design | Color | Total Vol., μL | Sterile | No. per Pack | No. Per Case |
|----------|-------------|-------------|-------|---------------------------|---------|--------------|--------------|
| 278605 | Non-Treated | 96 U | Clear | 1.0 | No | 4 | 32 |
| 278606 | Non-Treated | 96 U | Clear | 1.0 | Yes | 4 | 32 |

Thermo Scientific Nunc 96-well Filter Plates



Nunc Filter Plates are optimized for efficient purification of high-quality plasmid DNA or PCR products.

Designed specifically for high-throughput sample processing, these 96-well filter plates are made of polypropylene, offering chemical resistance and mechanical strength. They are ideal for DNA plasmid preparations and PCR cleanups.

details

- Designed specifically for high-throughput sample processing
- Suitable for vacuum, filtration, centrifugation or positive pressure techniques
- Polyethylene terephthalate (PET) frit in fritted plate has 20 μm pore size
- Shared wall configuration gives reduced plate height, wider wells for faster processing, higher yields and less clogging
- Purified DNA is suitable for downstream applications such as sequencing and restriction digestion
- Glass Fiber plate has PET frit and two layers of glass fiber membrane for binding DNA

Recommended for: Protein purification, lysate clarification, general filtration.

Compliance: All Nunc microplates meet the recommendation of American National Standards Institute (ANSI).

Flow diagram for plasmid DNA purification

Procedure:

Figure 1.
Procedure on
how to use
Nunc Filter
Plates for cost
effective DNA
purification.

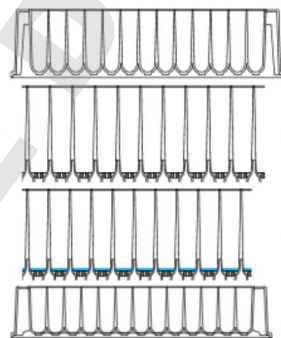

Grow E. Coli cells in a sterile 2 mL DeepWell Plate (Cat. No. 278743). (overnight)
Lyse bacteria and neutralize lysate. (15 min.)

Clarify plasmid DNA with Fritted Filter Plate (Cat. No. 278011). (1 min.)

Bind plasmid DNA to Glass Fiber Filter Plate (Cat. No. 278010). (3 min.)
Wash and dry membrane. (8 min.)

Elute pure plasmid DNA with TE into 1 mL reception DeepWell Plate (Cat. No. 260252). (12 min.)

Nunc 96-well Filter Plates

| Cat. No. | Surface | Well Design | Color | Total Vol., μL | Working Vol., μL | Frit Size, μm | Sterile | No. per Pack | No. Per Case |
|----------|-------------|--|---------|---------------------------|-----------------------------|--------------------------|---------|--------------|--------------|
| 278010 | Non-Treated | 96-well Glass Fiber Filter (Binding) Plate | Natural | 1.3 | 1.0 | 20* | No | 5 | 50 |
| 278011 | Non-Treated | 96-Fritted Well Deep Well Plate | Natural | 1.3 | 1.0 | 20 | No | 5 | 50 |
| 278012 | Non-Treated | 96-Unfritted well Deep Well Plate | Natural | 1.3 | 1.0 | | No | 5 | 50 |

* Features two layers of glass fiber membrane on top of PET frit

Thermo Scientific 384-well Polystyrene Plates

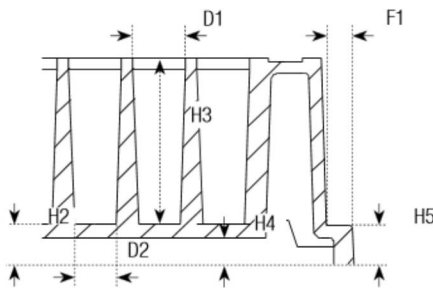
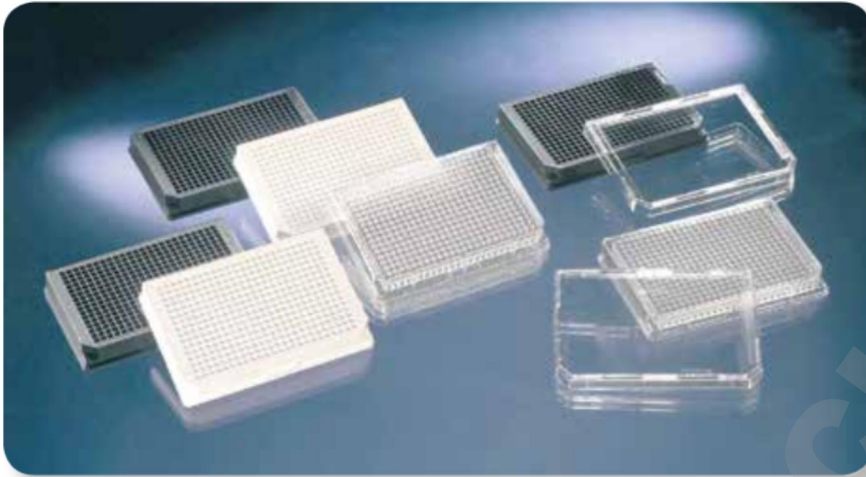

384-well Polystyrene Plates are optimized for robotics, plate readers and liquid handling systems. 384-well plates allow sample and reagent volume reduction, providing cost savings and allowing more samples to be screened.

Nunc 384-well Polystyrene Plates have rounded square-well geometry, eliminating wicking.

details

- Clear polystyrene has excellent optical properties, making it ideal for optical measurements
- Untreated polystyrene is hydrophobic and is suited for the growth of suspension cultures that can proliferate and grow without attachment
- Untreated surfaces are ideal for adding coatings in your lab
- Cell Culture Treated: The Nunclon Delta cell culture treated surface is a hydrophilic surface that promotes cell attachment and growth
- Flexible working volumes: 10-100 μL

Compliance: Thermo Scientific microplates meet the recommendation of American National Standards Institute (ANSI).

| | mm |
|---|-----------------------------------|
| Total height of plate | 14.4 \pm 0.25 |
| H2 Vertical distance from inside well bottom to resting plane | 2.6 |
| H3 Inside depth of well | 11.7 |
| H4 Vertical distance from external well bottom to resting plane | 1.7 |
| H5 Height of flange | 2.7 |
| D1 Well diameter, top | 3.7 |
| D2 Well diameter, bottom | 2.7 |
| F1 Depth of flange | 1.9 |



384-well Polystyrene Plates

| Cat. No. | Surface | Well Design | Color | Total Vol., μ L | Sterile | Lid | No. per Pack | No. Per Case |
|----------|--------------|--------------|-------|---------------------|---------|-----|--------------|--------------|
| 164610 | Cell culture | 384 F | White | 120 | Yes | Yes | 10 | 30 |
| 164564 | Cell culture | 384 F | Black | 120 | Yes | Yes | 10 | 30 |
| 164555 | Cell culture | 384 F | Clear | 120 | Yes | No | 25 | 100 |
| 164688 | Cell culture | 384 F | Clear | 120 | Yes | Yes | 10 | 30 |
| 242757 | Non-treated | 384 F | Clear | 120 | Yes | Yes | 10 | 30 |
| 242765 | Non-treated | 384 F | Clear | 120 | Yes | Yes | 1 | 30 |
| 262160 | Non-treated | 384 F | Clear | 120 | No | No | 25 | 100 |
| 262260 | Non-treated | 384 F | Black | 120 | No | No | 25 | 100 |
| 262360 | Non-treated | 384 F | White | 120 | No | No | 25 | 100 |
| 265202 | Non-treated | 384 F | Clear | 120 | Yes | Yes | 25 | 100 |
| 265203 | Non-treated | 384 F | Clear | 120 | Yes | No | 25 | 100 |
| 165195 | Cell culture | 384 F | White | 120 | Yes | No | 25 | 100 |
| 95040000 | Non-Treated | 384 C-Square | Clear | 70 | No | No | 1 | 50 |
| 95040330 | Non-Treated | 384 C-Square | Black | 70 | Yes | Yes | 1 | 40 |
| 460372 | Maxisorp | 384 F | White | 120 | No | No | 10 | 30 |
| 460518 | Maxisorp | 384 F | Black | 120 | No | No | 10 | 30 |
| 464718 | Maxisorp | 384 F | Clear | 120 | No | No | 10 | 30 |
| 8755 | Immulon 4HBX | 384 F | Clear | 120 | No | No | 1 | 50 |
| 436009 | Amino | 384 F | Clear | 120 | No | No | 5 | 30 |
| 436012 | Amino | 384 F | Black | 120 | No | No | 5 | 30 |
| 436018 | Streptaidin | 384 F | White | 120 | No | No | 1 | 15 |

† Not Available in the Americas

Thermo Scientific Nunc 384 Shallow Well Standard Height Plates

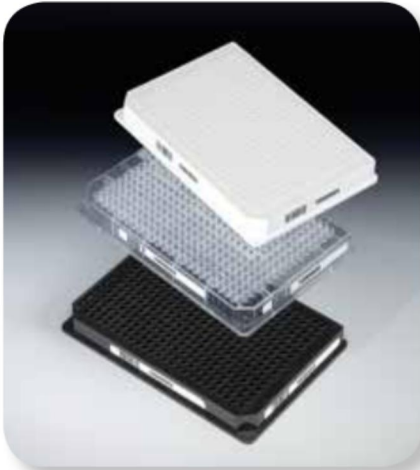

Nunc 384-well shallow well standard height clear plates

Nunc 384-well Shallow Well Standard Height Plates provide cost savings in samples and reagents by reducing the total well volume to 25 μL .

The standard height of the plate allows the use of automation without making adjustments to robotics, plate readers or liquid handlers.

details

- Untreated polystyrene is hydrophobic and suited for growth of suspension cultures that can proliferate and grow without attachment
- Untreated surfaces are ideal for adding coatings in your lab
- Working volume: 2–20 μL /well
- 25 μL total volume saves reagents
- Clear polystyrene has excellent optical properties making it ideal for optical measurements
- Black microplates are recommended for fluorescence measurements with minimum crosstalk and background fluorescence
- White microplates are recommended for luminescence measurements with maximum reflection and minimal autoluminescence

Compliance: Nunc plates meet the recommendation of American National Standards Institute (ANSI).

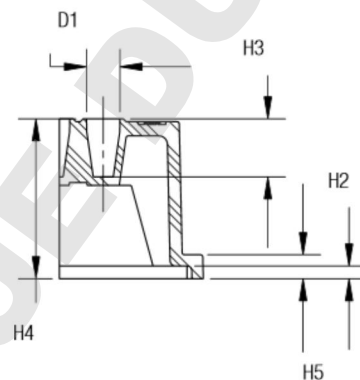

| | mm |
|---|--------------|
| Total height of plate: | 14.35 |
| H2 vertical distance from stacking rim to resting plane | 1.14 |
| H3 Inside depth of well | 5.21 |
| H4 Vertical distance from external well bottom to resting plane | 8.4 |
| 5 Height of flange | 2.16 |
| D1 Well diameter, top | 0.3 |

Nunc 384-Well ShallowWell Standard Height Plates; Round Upper Structure, Flat bottom.

| Cat. No. | Surface | Well Design | Color | Total Vol., μL | Sterile | Lid | No. per Pack | No. Per Case |
|----------|-------------|-------------|-------|---------------------------|---------|-----|--------------|--------------|
| 264704 | Non-treated | 384 F | Clear | 25 | No | No | 25 | 100 |
| 264705 | Non-treated | 384 F | Black | 25 | No | No | 25 | 100 |
| 264706 | Non-treated | 384 F | White | 25 | No | No | 25 | 100 |

Thermo Scientific Nunc 384-well Optical Bottom Plates

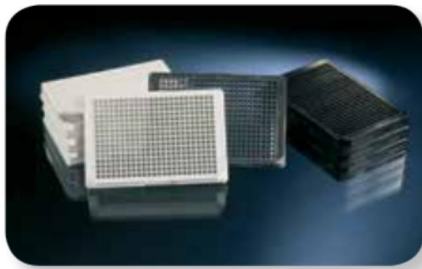

Nunc 384-well Optical Bottom Plates are ideal for microscopic applications.

The black microplates are recommended for fluorescence measurements with minimum crosstalk and background fluorescence. White microplates are recommended for luminescence measurements, offering maximum reflection and minimal autoluminescence.

Rounded-square wells provide maximum access for dispensers and readers.

details

- Poly-D-Lysine and Collagen coatings are ideal for cells with low adherence or growth; the uniform coating creates a positive charge on the surface that ensures cell attachment, growth and differentiation
- Cell Culture Treated: The Nunclon Delta cell culture treated surface is a hydrophilic surface that promotes cell attachment and growth
- Untreated polystyrene is hydrophobic and is suited for the growth of suspension cultures that can proliferate and grow without attachment and are ideal for adding coating in your own lab
- Polystyrene upper structure (available in black or white) with either a #1.5 cover glass or polystyrene base
- Working volume: 10 to 120 μL /well

Compliance: All Nunc microplates meet the recommendation of American National Standards Institute (ANSI).

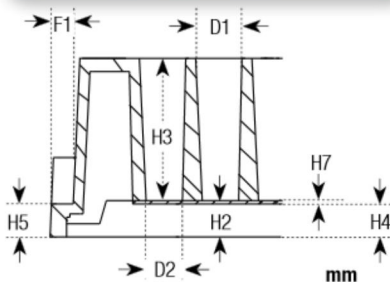

| | mm |
|---|--------------------|
| Total height of plate | 14.4 ± 0.25 |
| H2 Vertical distance from inside well bottom to resting plane | 2.7 |
| H3 Inside depth of well | 11.6 |
| H4 Vertical distance from external well bottom to resting plane | 2.5 |
| H5 Height of flange | 2.7 |
| H7 Bottom thickness | 0.3 |
| D1 Well diameter, top | 3.7 x 3.7 |
| D2 Well diameter, bottom | 2.9 x 2.9 |
| F1 Depth of flange | 1.8 |

Nunc 384-Well Optical Bottom Plates

| Cat. No. | Surface | Well Design | Color | Total Vol., μL | Sterile | Lid | No. per Pack | No. Per Case |
|----------|--------------------------------|-------------|-------|---------------------------|---------|-----|--------------|--------------|
| 142761** | Cell Culture | 384 F | Black | 120 | Yes | Yes | 10 | 30 |
| 142762** | Cell Culture | 384 F | White | 120 | Yes | Yes | 10 | 30 |
| 152029 | Poly-D-Lysine | 384 F | Black | 120 | No | Yes | 10 | 30 |
| 152041 | Collagen I | 384 F | Black | 120 | No | Yes | 10 | 30 |
| 164586* | Cell Culture-Coverglass bottom | 384 F | Black | 120 | Yes | No | 6 | 30 |
| 164730** | Cell Culture | 384 F | Black | 120 | Yes | No | 10 | 30 |
| 240074* | Non-Treated Coverglass | 384 F | Black | 120 | No | No | 5 | 30 |
| 242763 | Non-Treated | 384 F | White | 120 | No | No | 10 | 30 |
| 242764 | Non-Treated | 384 F | Black | 120 | No | No | 10 | 30 |

* 1.5 Coverglass ** Certified

Thermo Scientific 384-well Polypropylene Plates



Nunc 384-well Polypropylene Plates provide cost savings when storing compounds for small volume applications.

Polypropylene is the ideal storage plate because it has a lower binding capacity so proteins or DNA will not bind, allowing complete sample recovery. Withstands temperatures from -80°C to +121°C. Offered in a variety of colors for quick identification of your storage plates.

details

- Conical wells offer optimal sample recovery
- Rounded square wells minimize wicking (capillary action)
- The variety of colors is for quick identification of storage plates
- Chemically resistant to DMSO
- Round bottom improves mixing
- U384-well plates working volume range: 10-100 μL /well
- V384-well plates working volume range: 4-120 μL /well
- Certified RNase-free

Compliance: All Thermo Scientific microplates meet the recommendation of American National Standards Institute (ANSI).

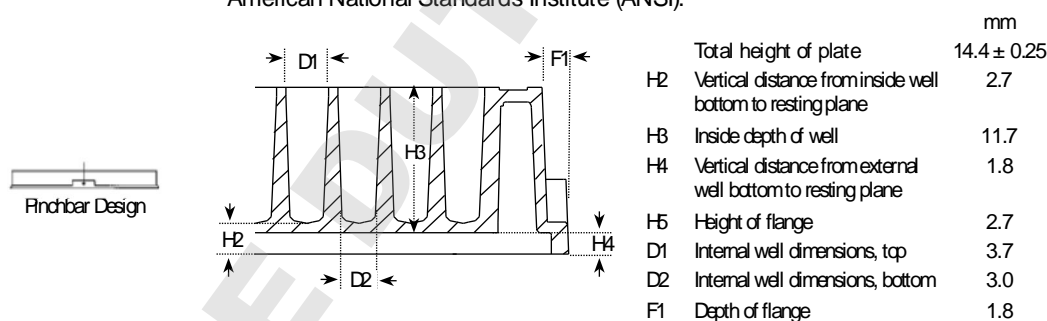

384-Well Conical Bottom Polypropylene Plates

| Cat. No | Well Design | Color | Total Vol., μL | Sterile | Lid | No. per Pack | No. Per Case |
|---------|-------------|---------|---------------------------|---------|-----|--------------|--------------|
| 264573 | 384 U | Natural | 120 | No | No | 20 | 120 |
| 264574 | 384 U | Natural | 120 | Yes | No | 20 | 120 |
| 264575 | 384 U | White | 120 | No | No | 20 | 120 |
| 264576 | 384 U | Black | 120 | No | No | 20 | 120 |
| 264579 | 384 U | Blue | 120 | No | No | 20 | 120 |
| 264675* | 384 U | White | 120 | No | No | 20 | 120 |
| 4305 | 384 V | White | 145 | Yes | No | 10 | 80 |
| 4306 | 384 V | Black | 145 | Yes | No | 10 | 80 |
| 4307 | 384 V | White | 145 | No | No | 10 | 80 |
| 4308 | 384 V | Black | 145 | Yes | No | 10 | 80 |
| 4309 | 384 V | Natural | 145 | Yes | No | 10 | 80 |
| 4312 | 384 V | Natural | 145 | No | No | 10 | 80 |

* Low cross-talk

Thermo Scientific Nunc 384-well ShallowWell Standard Height Polypropylene Plates

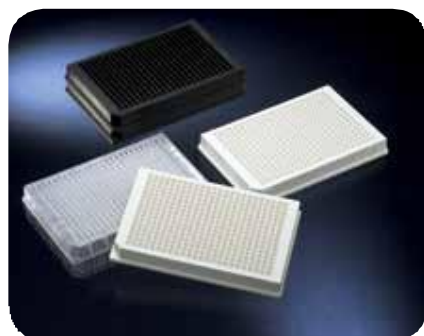

Nunc 384-well ShallowWell Standard Height Polypropylene Plates provide cost savings when storing compounds for small volume applications.

Polypropylene is ideal for storage plates because of its lower binding capacity so proteins or DNA will not bind and allows complete sample recovery. It withstands temperatures from -80°C to +121°C and is offered in a variety of colors to allow quick identification of your storage plates.

Polypropylene is a low-binding and chemically resistant surface making this plate ideal for storage.

details

- Rounded well bottoms are optimized for mixing and sample recovery
- Chemical resistant to DMSO
- Rounded Square wells minimize wicking (capillary action)
- Natural plates for storage or colorimetric assays
- White plates for storage identification of luminescent assays
- Black plates for storage or fluorescent assays
- Working volume range: 2-35 µ/well
- Certified RNase-free

Compliance: All Nunc microplates meet the recommendation of American National Standards Institute (ANSI).

Nunc 384-ShallowWell Standard Height Polypropylene Plates

| Cat. No. | Surface | Well Design | Color | Total Vol., µL | Sterile | Lid | No. per Pack | No. Per Case |
|----------|-------------|-------------|---------|----------------|---------|-----|--------------|--------------|
| 267459 | Non-Treated | 384 U | Natural | 58 | No | No | 25 | 100 |
| 267460 | Non-Treated | 384 U | Natural | 58 | Yes | No | 25 | 100 |
| 267461 | Non-Treated | 384 U | Black | 58 | No | No | 25 | 100 |
| 267462 | Non-Treated | 384 U | White | 58 | No | No | 25 | 100 |

u For custom barcoded plates, visit www.thermoscientific.com/barcodeconfigurator

Thermo Scientific Nunc DeepWell Plates:

Delivering the low-bind performance of specialty microplates at lower cost

Microplates offer a convenient solution for manipulating and storing large numbers of samples. To prevent sample loss caused by the non-specific binding of biomolecules, polypropylene plates with low-binding characteristics are essential.

Expensive specialty storage plates offer a solution. But testing* has shown that Thermo Scientific™ Nunc™ DeepWell plates offer the same level of high performance more economically, including low binding and a high centrifugation RCF rating.

*Tested for centrifugation applications in a Thermo Scientific™ Lynx™ 6000 centrifuge, using the BioFlex HC rotor and microplate adapter. All plates reached the RCF of 7,068 xg at the maximum speed of the rotor.

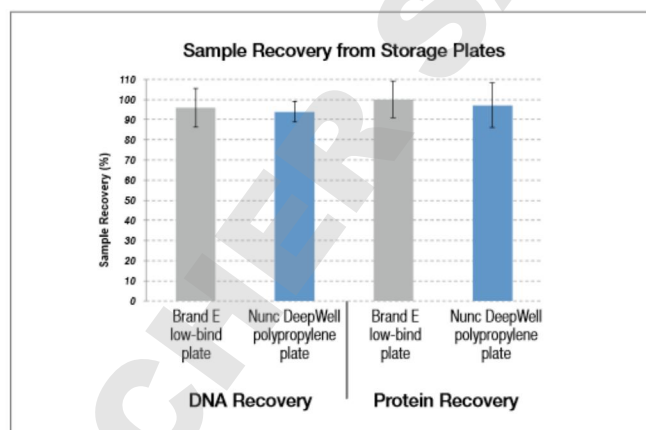

Percent recovery of DNA and protein samples stored in polypropylene deepwell microplates. Error bars represent one standard deviation.



For more information, visit www.thermoscientific.com/plateguide

Thermo Scientific Nunc 384 DeepWell Polypropylene Plates



Nunc 384 DeepWell Plates are ideal for compound library storage. The deep well design accommodates larger working volumes, and the rounded square well minimizes wicking (capillary action).

Polypropylene is the ideal storage plate material, with a lower binding capacity so proteins or DNA will not bind. Allows complete sample recovery.

Polypropylene is a low-bind and chemically resistant surface, making this plate ideal for storage.

details

- Raised rims around each well are ideal for heat or adhesive sealing
- Rounded wells are optimized for mixing
- Compatible with robotics and automation
- Optimized for liquid handling systems
- Working volume range: 5-240 μL /well
- Certified RNase-free

Compliance: All Nunc microplates meet the recommendation of American National Standards Institute (ANSI).

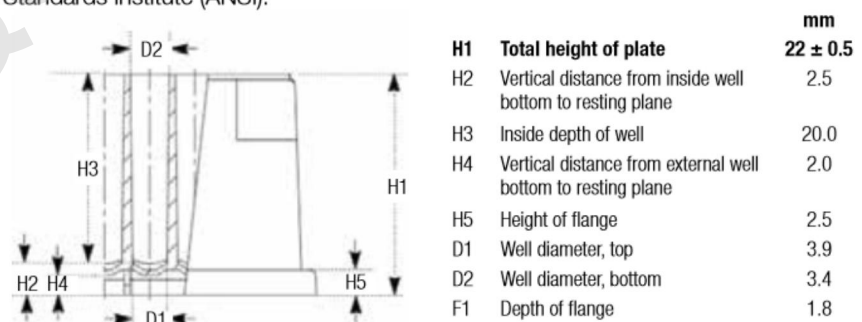

Nunc DeepWell 384-Well Plate

| Cat. No. | Surface | Well Design | Color | Total Vol., μL | Sterile | Lid | No. per Pack | No. Per Case |
|----------|-------------|-------------|---------|---------------------------|---------|-----|--------------|--------------|
| 269390 | Non-Treated | 384 U | Natural | 252 | No | No | 5 | 60 |

Thermo Scientific Nunc 1536-well Polystyrene High Base Microplates



Nunc 1536-well Polystyrene High Base Microplates are ideal for high-throughput screening. The skirted design around the base of the plate is optimal for robotic handling.

Work with small volumes and screen four times as many samples in one plate.

details

- Black plates are recommended for fluorescence measurements with minimum crosstalk and background fluorescence
- White microplates are recommended for luminescence measurements with maximum reflection and minimal autoluminescence
- Cell Culture Treated: The Nunclon Delta cell culture treated surface is a hydrophilic surface that promotes cell attachment and growth.
- Working range: 2-10 μL /well

Compliance: All Nunc microplates meet the recommendation of American National Standards Institute (ANSI).

Nunc 1536-Well High Base Microplates

| Cat. No. | Surface | Well Design | Color | Total Vol., μL | Sterile | Lid | Nb. per Pack | Nb. per Case |
|----------|--------------|-------------|-------|---------------------------|---------|-----|--------------|--------------|
| 164707 | Cell Culture | 1536 F | Clear | 13.4 | Yes | Yes | 25 | 100 |
| 164708 | Cell Culture | 1536 F | Black | 13.4 | Yes | Yes | 25 | 100 |
| 164709 | Cell Culture | 1536 F | White | 13.4 | Yes | Yes | 25 | 100 |
| 264710 | Non-Treated | 1536 F | Clear | 13.4 | Nb | Nb | 25 | 100 |
| 264711 | Non-Treated | 1536 F | Black | 13.4 | Nb | Nb | 25 | 100 |
| 264712 | Non-Treated | 1536 F | White | 13.4 | Nb | Nb | 25 | 100 |

Thermo Scientific Nunc 1536-well Polystyrene Microplates

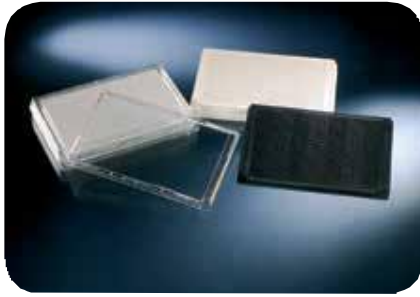

Nunc 1536-well Polystyrene Microplates are ideal for high-throughput screening.

Work with small volumes and screen four times as many samples in one plate.

details

- Low plate height is optimized for stacking
- Black microplates are recommended for fluorescence measurements with minimum crosstalk and background fluorescence
- White microplates are recommended for luminescence measurements with maximum reflection and minimal autoluminescence
- Working well volume: 1-10 μL /well

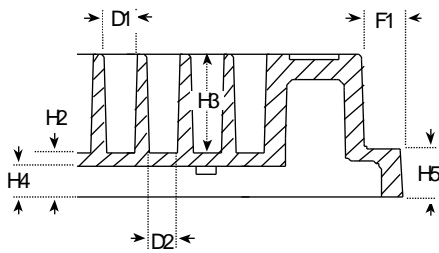

Compliance: All Nunc microplates meet the recommendation of American National Standards Institute (ANSI).

| | mm |
|---|-----|
| Total height of plate | 7.4 |
| H2 Vertical distance from inside well bottom to resting plane | 2.4 |
| H3 Inside depth of well | 5.0 |
| H4 Vertical distance from external well bottom to resting plane | 1.5 |
| H5 Height of flange | 2.5 |
| D1 Well diameter, top | 1.7 |
| D2 Well diameter, bottom | 1.5 |
| F1 Depth of flange | 1.8 |

Nunc 1536-Well Microplates Plates

| Cat. No. | Surface | Well Design | Color | Total Vol., μL | Sterile | Lid | No. per Pack | No. Per Case |
|----------|-------------|-------------|-------|---------------------------|---------|-----|--------------|--------------|
| 253601 | Non-Treated | 1536 F | Black | 13.4 | Nb | Nb | 30 | 90 |
| 253607 | Non-Treated | 1536 F | White | 13.4 | Nb | Nb | 30 | 90 |
| 253614 | Non-Treated | 1536 F | Clear | 13.4 | Nb | Nb | 30 | 90 |

u For custom barcoded plates, visit www.thermoscientific.com/barcodeconfigurator

Thermo Scientific Microplate Lids

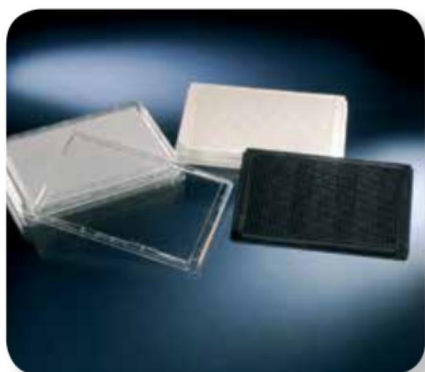

Microplate Lids protect samples from contamination and evaporation during assay processing, incubation or storage.

details

- 96-well lids with individual condensation rings
- Lids have notches for quick orientation
- Universal lids can be used on any standard height plate on the market

Nunc Microplate Lids

| Cat. No. | Height, without stacking holders, mm | Cut-off Corners | Condensation Rings | Evaporation Barrier | Color | Sterile | No. per Pack | No. Per Case |
|--|--------------------------------------|-----------------|--------------------|---------------------|-------|---------|--------------|--------------|
| Standard Lids, for 96-MicroWell Plates | | | | | | | | |
| With condensation rings and evaporation rim; Polystyrene; External dimensions 127 x 85 mm | | | | | | | | |
| 263339 | Standard, 7.9 | Long Side | Yes | Yes | Clear | No | 5 | 100 |
| 264122 | Standard, 7.9 | Long Side | Yes | Yes | Clear | Yes | 1 | 50 |
| 264623 | Standard, 7.9 | Long Side | Yes | Yes | Clear | Yes | 20 | 60 |
| Standard Lids for 384-well Plates | | | | | | | | |
| With evaporation rim; Polystyrene; External dimensions 127 x 85 mm | | | | | | | | |
| 264611 | Standard, 7.9 | Long side | No | Yes | Clear | Yes | 1 | 60 |
| 264612 | Standard, 7.9 | Long side | No | Yes | Clear | No | 20 | 180 |
| 264616 | Standard, 7.9 | Long side | No | Yes | Clear | Yes | 20 | 180 |
| White Lid, for 384- and 1536-well Plates and OmniTrays | | | | | | | | |
| Polystyrene; External dimensions 127 x 85 mm | | | | | | | | |
| 448143 | Standard, 7.9 | Long side | No | No | White | No | 20 | 120 |
| Universal Lid for 384- and 1536-well Plates | | | | | | | | |
| With side cut-out and evaporation rim; Polystyrene; External dimensions 127 x 85 mm | | | | | | | | |
| 250002 | Standard, 8.34 | No | No | No | Clear | Yes | 20 | 60 |
| 250003 | Standard, 8.34 | No | No | No | Clear | No | 20 | 60 |
| 250005 | Standard, 8.34 | No | No | No | Clear | No | 20 | 180 |
| LowBot Lids, Universal Version for 384- and 1536-well Plates | | | | | | | | |
| With condensation rings and evaporation rim; Polystyrene; External dimensions 127 x 85 mm | | | | | | | | |
| 253623 | Low profile, 4.6 | No | No | Yes | Clear | No | 25 | 100 |
| 253624 | Low profile, 4.6 | No | No | Yes | Clear | Yes | 25 | 100 |
| Automation Friendly Lids; External dimensions 127 x 85 mm | | | | | | | | |
| 4954 | Automation Friendly, 8.9 | No | No | Yes | Clear | Yes | 10 | 80 |
| 4955 | Automation Friendly, 8.9 | No | No | Yes | Black | Yes | 10 | 80 |

barcode configurator



Simplify sample tracking using Thermo Scientific™ Nunc™ Microplates with custom barcodes created by the Nunc Barcode Configurator.

Barcodes provide a tool for managing large quantities of data and establishing historical identification of plate content at any point in an assay or method. Creating a customized barcode is fast and easy using our simple step-by-step interface. Bring the power of bar coding to your process:

- Choose from 5 code types to best meet your application needs
- Select your label location – apply to one or more plate sides
- No repeats – guaranteed!
- Human-readable option, including positions and highlight color
- Sequences archived for data management
- Print a sample barcode to ensure compatibility with your reader

To create your own custom barcodes, go to
www.thermoscientific.com/barcodeconfigurator

Thermo Scientific Nunc Barcode Scanners



Nunc Barcode Scanners with “Plug and Play” functionality play a critical role in sample tracking.

The scanner can automatically switch to read codes: 128A, 128B, 128C, 39 and Interleave 2/5. Convenient and simple to use with a Microsoft® Excel® spreadsheet.

Durable, low cost, and easy to use – simply plug into a USB or keyboard port.

details

- Scanners automatically switch between Code 128, Code 39, Interleave 2 of 5 and several other barcodes
- Must be in contact with the barcode to read

Nunc Barcode Scanners

| Cat. No. | For Use with |
|----------|---|
| 330040 | Nunc Bar Code Scanner; designed to plug into any keyboard |
| 330050 | Nunc Bar Code Scanner; designed to plug into any USB port |



Thermo Scientific Nalgene Horizontal Storage Racks for Microplates



Thermo Scientific™ Nalgene™ Horizontal Storage Racks provide a secure, convenient storage system and allow transport of samples in standard and deepwell plates.

These racks are ideal for genome library storage, DNA and RNA libraries, and storage of compounds for high-throughput screening.

details

- Horizontal design fits most refrigerators and freezers
- Retainer clip on each compartment holds plates securely in place
- Handles on tops and sides for easy transport
- Label holder for easy identification of rack contents

Nalgene Horizontal Storage Racks for Microplates

| Cat. No. | Array | Capacity | Holds | L x W x H, cm (in.) | No. per Case |
|-----------|-------|--|-----------------------------------|-------------------------------------|--------------|
| 5039-0048 | 4 x 4 | 80 Low profile, 48 Standard, 16 Deep well | 48 standard plates (16 deep well) | 38.7 x 13.9 x 21.6 (15 x 5.5 x 8.5) | 1 |
| 5039-0072 | 4 x 6 | 120 Low Profile, 72 standard, 24 Deep well | 72 standard plates (24 deep well) | 57.9 x 13.9 x 12.6 (23 x 5.5 x 8.5) | 1 |

Thermo Scientific Nunc Microplate Plastic Storage Racks

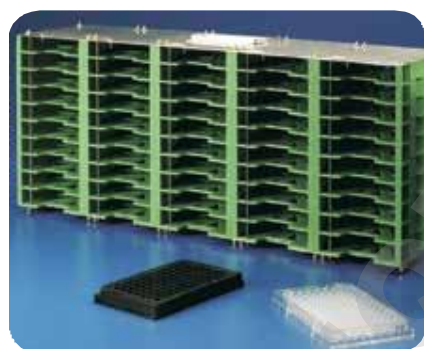

Nunc Plastic Storage Racks provide a secure, convenient storage system and allow transport of samples in standard and deepwell plates.

These racks are ideal for genome library storage, DNA and RNA libraries, and storage of compounds for high-throughput screening.

details

- Horizontal design fits chest, upright freezers and incubator
- Retainer clip holds plates securely in place
- Handles on top and side for easy transport
- Locking bar keeps plates secure
- Handle allows convenient transport
- Freezer compatible down to -80°C
- Not for use in liquid/vapor nitrogen

Nunc Microplate Plastic Storage Racks

| Cat. No. | Type | Style | L x W x H, cm (in.) | Shelf Height, cm (in.) | Color |
|----------|-----------------|------------------|-----------------------------------|------------------------|-------|
| 344260 | Standard Height | 10 Tall | 23 x 10 x 14 (9.05 x 3.94 x 5.5) | 2 (3/4) | Green |
| 344280 | Standard Height | 10 Tall x 5 Wide | 25 x 51 x 14 (9.88 x 20.13 x 5.5) | 2 (3/4) | Green |
| 344380 | DeepWell | 5 Tall x 15 Wide | 25 x 51 x 14 (9.88 x 20.13 x 5.5) | 5 (2) | Green |

Thermo Scientific Nunc Vertical Microplate Storage Racks



Nunc Vertical Microplate Storage Racks provide a secure, convenient storage system and allow transport of samples in standard and deepwell plates.

These racks ideal for genome library storage, DNA and RNA libraries, and storage of compounds for high-throughput screening.

details

- Adjustable shelves to fit any plate
- Vertical design optimizes room in chest and upright freezers
- Retainer clip holds plates securely in place
- Handles on tops for easy transport
- Alignment rod on the front side secures plates and allows barcode reading
- Aluminum
- Autoclavable

Accommodates:

- 18 Low Profile Microplates
- 10 Standard Height Microplates
- (6) 1 mL Deep Well Plates
- (5) 2 mL Deep Well Plates

Nunc Vertical Microplate Storage Racks

| Cat. No. | Color | Material | L x W cm (in.) | No. per Case |
|----------|---------|----------|--------------------------|--------------|
| 367002 | Natural | Aluminum | 13.5 x 9.5 (5.31 x 3.74) | 1 |

Thermo Scientific Nunc-Immuno Washers



Nunc-Immuno Washers allow flexible washing procedures and are ideal for low-throughput labs that do not have microplate washers.

The Nunc Immuno Washer is available in 8- and 12-channel versions to fit all 96-well plates.

Adjustable to all well shapes. No electrical connections required.

details

- Uniform and efficient washing
- Simple and easy to use
- Can be autoclaved for sterilization
- Design eliminates overfilling and cross-contamination
- Autoclavable at 121°C (250°F) for sterilization of immuno washer

Ordering Information: Dimensions: 10.25 L x 4.5W x 3.75 in. D (26 x 11.5 x 9.5 cm).

Includes: Two thumbscrews and one ruler for required adjustments for washing alternative well types; rack for secure storage support; spare parts kit for routine maintenance and cleaning wire. Spare parts kit includes five different O-rings and one spring.

Nunc-Immuno Washers

| Cat. No. | Description | Includes |
|----------|-------------------|---------------------------------|
| 470174 | 8-Channel Washer | Spare parts kit, ruler and rack |
| 470175 | 12-Channel Washer | Spare parts kit, ruler and rack |

Thermo Scientific Nunc Replication System

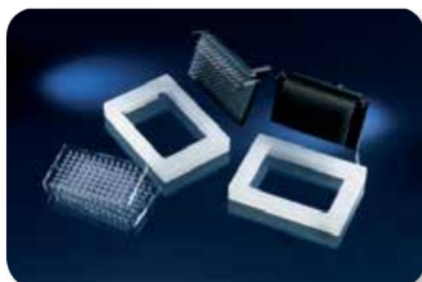

Nunc Replication Systems are designed for the replication of DNA libraries and are ideal for transferring small volumes from plate to plate.

These replication systems work with Nunc 96- and 384-well microplates.

Ideal for transferring small volumes of inoculum from plate to plate or membrane.

details

- Pins transfer 1.0 μL of liquid or 0.1 μL to solid supports
- Pins are flame-proof stainless steel for sterilization
- MicroWell copier alignment device simplifies conversion of 96-MicroWell plates to 384-well format
- Flame-proof stainless steel pins on 96- and 384-Pin Replicator
- For use with 96- and 384-well Plate and OmniTray

Nunc Replication System

| Cat. No. | Description | Fits | L x W x H, mm | Material | Volume, μL |
|----------|-------------|-----------|----------------------|---|-----------------------|
| 250393 | Replicator | 384-wells | 121.6 x 83.3 x 135.4 | Anodized aluminum with stainless steel pins | 1 \pm 0.1 |
| 250520 | Replicator | 96-wells | 121.6 x 83.3 x 135.4 | Anodized aluminum with stainless steel pins | 1 \pm 0.1 |

Thermo Scientific Nalgene Disposable Polypropylene Robotic Reservoirs



Nalgene Disposable Polypropylene Robotic Reservoirs with a standard microplate format and 300 mL volume offer greater walk-away time and assay efficiency.

The convoluted design minimizes dead volume and has baffles to reduce splashing. The flat bottom version is designed to meet a variety of assay needs in both manual and automated environments.

details

- Convoluted bottom design is most effective with a 96-well format
- Flat Bottom design can be used with single, 6-, 12-, 96-, 384- and 1536-well formats
- Polypropylene construction withstands robotic liquid handling, making it easier to run automated assays and increasing walk-away time
- Compatible with most robotic arms, plate stackers (hotels), plate cranes and platform configurations
- Reservoir volume is 300 mL (345 mL brim capacity), with molded-in graduations every 100 mL
- Nestable, for easy automated stacking and handling

Dimensions: 3.4 L × 5 W × 1.75 in. H (86 × 128 × 43 mm)

Compliance: Meets the recommendation of American National Standards Institute (ANSI).

Nalgene Disposable Polypropylene Robotic Reservoirs

| Cat. No. | Bottom Shape | Total Vol., μ L | Sterile | No. per Pack | No. Per Case |
|-----------|--------------|---------------------|---------|--------------|--------------|
| 1200-1300 | Flat | 300 | No | 4 | 40 |
| 1200-1301 | Flat | 300 | Sterile | 4 | 40 |
| 1200-2300 | Convoluted | 300 | Sterile | 4 | 40 |
| 1200-2301 | Convoluted | 300 | No | 4 | 40 |

Thermo Scientific Nunc 96-well Cap Mats



Nunc 96-well Cap Mats for polypropylene plates will protect well contents during short-term or long-term storage of chemicals or compounds.

details

- Chemically resistant and pierceable; withstand low temperature to -80°C
- Pre-slit silicone well caps permit a pipette tip or probe to enter the well without damage to the cap
- The variety of colors for quick identification of storage plates
- Silicone caps with pre-slit are solvent resistant; should not be subjected to 100% DMSO

Notes: Capmats fit both 96-well Polypropylene DeepWell and Standard Height Shared Wall Plates. Cat. No. 276011 preslit silicone caps can be pierced repeatedly. Do not use pre-slit silicone with 100% DMSO.

Nunc 96-Well Cap Mats

| Cat. No. | Well | Under Well Shape | Pierceable | Slit | Color | Sterile | No. per Pack | No. Per Case |
|----------|------|------------------|-------------|------------------------------------|---------|---------|--------------|--------------|
| 276000** | 96 | Round | Pierceable* | Not preslit | Natural | Yes | 1 | 50 |
| 276002** | 96 | Round | Pierceable* | Not preslit | Natural | No | 5 | 50 |
| 276003** | 96 | Round | Pierceable* | Not preslit | Yellow | No | 5 | 50 |
| 276004** | 96 | Round | Pierceable* | Not preslit | Red | No | 5 | 50 |
| 276005** | 96 | Round | Pierceable* | Not preslit | Blue | No | 5 | 50 |
| 276011** | 96 | Round | Pierceable* | Preslit can be pierced repeatedly. | Natural | No | 10 | 50 |
| 4410 | 96 | Round | No | Not preslit | Natural | No | 100 | 100 |
| 4411-11 | 96 | Round | No | Not preslit | Natural | No | 10 | 10 |
| 4412-11 | 96 | Round | No | Not preslit | Natural | Yes | 10 | 10 |
| 4413-11 | 96 | Round | No | Not preslit | Natural | No | 240 | 240 |
| 4414-11 | 96 | Round | No | Not preslit | Natural | Yes | 240 | 240 |
| 4415 | 96 | Round | No | Not preslit | Natural | No | 240 | 240 |
| 4416 | 96 | Round | No | Not preslit | Natural | Yes | 240 | 240 |
| 4420 | 96 | Square | No | Not preslit | Natural | No | 100 | 100 |
| 4421 | 96 | Square | No | Not preslit | Natural | No | 10 | 10 |
| 4422 | 96 | Square | No | Not preslit | Natural | Yes | 10 | 10 |
| 4430-11 | 96 | Round | No | Not preslit | Natural | No | 100 | 100 |
| 4431-11 | 96 | Round | No | Not preslit | Natural | No | 10 | 10 |
| 4432-11 | 96 | Round | No | Not preslit | Natural | Yes | 10 | 10 |
| 9503230 | 96 | Square | Pierceable* | Not preslit | Natural | No | 5 | 50 |
| 9503233 | 96 | Square | Pierceable* | Not preslit | Natural | Yes | 1 | 25 |

* Pierceable by hypodermic ** For shared-wall plates * Not available in Americas * Only available in Americas

Thermo Scientific Nunc Sealing Tapes



Nunc Sealing Tapes minimize evaporation and protect samples from contamination and spilling.

Adhesive seals are ideal for all assay applications.

details

- Wide range of adhesive seals for every assay
- Adhesive seals effectively seal all microplate formats
- Pressure-sensitive adhesive is not tacky to touch, but forms a strong bond to the plate upon application of pressure
- Thin, lightweight tapes seal onto the plate with a convenient, handheld applicator (available separately, Cat. No. 250050)



Cat. No. 250050

Nunc Sealing Tapes

| Cat. No. | Material/Adhesive | Application | Color | Sterile | Pierceable | Certified RNase/DNase-free | Temperature Range | No. per Pack | No. Per Case |
|----------|-----------------------|---|--------|---------|------------|----------------------------|-------------------|--------------|--------------|
| 232698 | Aluminum/Acrylate | PCR and storage in 96-well plates | Silver | No | Yes | Yes | -80° to +150°C | 100 | 100 |
| 232699 | Aluminum/Acrylate | PCR and storage in 384-well plates | Silver | No | Yes | Yes | -80° to +150°C | 100 | 100 |
| 232701 | Polyolefin/Acrylate | Low autofluorescence; DMSO compatible; microscopy | Clear | No | No | No | -70° to +100°C | 100 | 100 |
| 232702 | Polyolefin/Acrylate | PCR; fluorescence assays; microscopy | Clear | No | No | Yes | -70° to +100°C | 100 | 100 |
| 235306 | Polyethylene/Silicone | Repeated piercing; low autofluorescence | Clear | No | Yes | No | -40° to +90°C | 100 | 100 |
| 235307 | Polyolefin/Silicone | Q-PCR; microscopy, lowest fluorescence | Clear | No | No | No | -70° to +100°C | 100 | 100 |
| 236269* | Polyester/Acrylate | Stiffer than polyolefin; general purpose | Clear | No | No | No | -20° to +100°C | 200 | 800 |
| 236272 | Polyester/Acrylate | Opaque; luminescence assay; bottom of plate | White | No | No | No | -40° to +80°C | 50 | 50 |
| 236366 | Polyester/Acrylic | Cell culture; sterile applications | Clear | Yes | No | No | -70° to +100°C | 200 | 800 |
| 236370* | Polyester/Silicone | General purpose; sample protection | Clear | No | No | No | -70° to +100°C | 100 | 100 |
| 236703 | Vinyl/Acrylate | For plate top or bottom; photo-sensitive samples | Black | No | No | No | -40° to +80°C | 50 | 50 |
| 236707 | Polyester/Acrylic | Convenient roll dispenser; general purpose | Clear | No | No | Yes | -20° to +100°C | 1000 | 1000 |
| 241205 | Rayon/Acrylate | Breathable; cell culture | White | Yes | Yes | No | -20° to +80°C | 20 | 50 |
| 249720 | Rayon/Acrylate | Breathable | White | No | No | Yes | -20° to +80°C | 50 | 50 |
| 276014 | Aluminum/Silicone | General use, PCR, photo-sensitive samples | Silver | No | Yes | Yes | -80° to +120°C | 100 | 100 |
| 250050 | | Hand held applicator promotes consistent seal | Gold | | No | No | | 2 | 2 |

+ Only available in the Americas * NOT available in the Americas

Thermo Scientific SuperSealer



Ensure a proper seal on plates, blocks and storage tube racks with the Thermo Scientific™ SuperSealer™.

Choose individual sealing options such as Thermo Scientific™ Matrix™ SepraSeal™ mats for liquid handling and single tube accessibility – or seal entire plates and blocks for storage with Thermo Scientific Nunc CapMats. Effectively apply adhesive tape seals and ensure a tight seal with the included SuperSealer Adhesive Seal Mat.

details

Sealing Simplicity

- Simplifies the sealing of plates, blocks and tube racks of virtually any height, with no adjustments needed, ensuring a secure and consistent seal
- Once the seal along with the plate, block or tube rack are placed into the drawer, simply close the door to initiate sealing

Sealing Flexibility

- Designed to work with Thermo Scientific Matrix SepraSeal mats, any CapMats or any pre-cut adhesive tape seal – you can be assured of getting a proper seal regardless of sealing option

Includes: Automatic cap, tape and SepraSeal mat applicator

Warranty: 1-Year, in-factory warranty on parts and labor

Certifications: CE Marked



| Specifications | |
|----------------------|--|
| Speed | 10-15 seconds/plate, block or rack of tubes |
| Dimensions W x D x H | 165 x 317.5 x 343 mm (6.5 x 12.5 x 13.5 in.) |
| Weight | 13.5 kg (30 lbs.) |
| Power Supply | 110-240V |

**The SuperSealer is designed to only work with full racks of tubes*

SuperSealer

| Cat. No. | Description |
|----------|---|
| 4110-11 | Thermo Scientific Super Sealer |
| 4423 | Mat for Adhesive Seal Application with Super Sealer |

Thermo Scientific ALPS 25 Manual Heat Sealer



Certifications: CE marked.

Unit includes Cat. No. AB-0563/1000.



The ALPS 25 Manual Heat Sealer is a simple-to-use, hand-operated sealer designed for low-throughput labs.

Heat sealing offers superior sample protection of storage and reaction plates in applications that include compound storage, sample archiving and PCR applications.

details

Sealing Flexibility

- Compatible with virtually any height microplate or block, including PCR plates
- Choose from a wide range of heat seals for any application, including piercable, optically-clear and permanent

Safe, Compact Design

- Built-in thermostat controls trigger automatic system shutoff to prevent overheating of the ALPS 25 sealer
- Lightweight with small footprint for ease of placement and relocation

Compatible Products: The ALPS 25 sealer is part of a complete line of microplate heat sealing instruments. For enhanced ergonomics, and variable time and temperature settings, consider the semi-automated Thermo Scientific ALPS 50 V microplate heat sealer. For automated microplate sealing, see the Thermo Scientific ALPS 3000.

Warranty: 1-year, in-factory warranty on parts and labor.

| Specifications | |
|-----------------------------|---|
| Operating Temperature Range | 10° to 35°C |
| Sealing Temperature Range | Ambient to 220°C |
| Operating Humidity Range | 10 to 80% |
| Fuse | 5A/110V/500W |
| Power Supply | 5A (AB-0384/110); 3.15A (AB-0384/220) |
| Dimensions W x D x H | 140 x 330 x 150 mm (5.5 x 13 x 5.9 in.) |
| Weight | 3.4 kg (7.5 lbs.) |

ALPS 25 Manual Heat Sealer

| Cat. No. | Description | No. per Case |
|-------------|--------------------------------------|--------------|
| AB-0384/110 | ALPS 25 Manual Heat Sealer, 100 Volt | 1 |
| AB-0384/220 | ALPS 25 Manual Heat Sealer, 220 Volt | 1 |

ALPS Heat Sealer Accessories

| Cat. No. | Description | No. per Case |
|--------------|---|--------------|
| AB-0563/1000 | 96Well PCR Plate Carrier | 1 |
| AB-0592 | Foil Stripper | 1 |
| AB-0724 | 384Well PCR Plate Carrier | 1 |
| AB-0827 | Standard Microplate Carrier | 1 |
| AB-1118 | 96Well (V) Conical Bottom Storage Plate Carrier | 1 |

Thermo Scientific ALPS 50 V Microplate Heat Sealer



The semi-automated ALPS 50 V Microplate Heat Sealer is designed to provide sealing consistency in low- to medium-throughput labs.

Heat sealing offers superior sample protection of storage and reaction plates in applications that include compound storage, sample archiving and PCR.

With the semi-automated ALPS 50 V microplate heat sealer, secure tight seals around individual wells eliminate sample loss through evaporation and cross contamination between wells. Choose from a wide range of heat seals, including pierceable, optically-clear and permanent, for any application.

details

Application Flexibility

- Simple on-board touch pad controls adjust sealing temperature and time for reproducible results
- Audible alarm indicates sealing completion

Ergonomic Design

- Compact footprint conserves bench space
- Counter lever handle design provides minimal strain when operating the instrument
- Lightweight, at only 7.2kg (15.9 lbs.) for easy relocation

Warranty: 1-year, in-factory warranty on parts and labor

Certifications: CE marked

Unit includes Cat. Nos. AB-0563/1000 and AB-0827.



| Specifications | |
|-----------------------------|---|
| Temperature Setpoint Range | 125° to 200°C in 1°C increments |
| Time Set Point Range | 1 to 9 seconds in 0.5 second increments |
| Operating Temperature Range | 18° to 30°C |
| Humidity Control | 20-80% noncondensing |
| Power Rating | 100-130V – T3.15A (IEC 127) or 220-240V – T1.6A (IEC 127) |
| Power Supply | 100-130 VAC, 50-60Hz or 220-240 VAC, 50-60Hz, 350W fuse |
| Fuse | 350W |
| Mains Input Connector | IEC 320 |
| Dimensions W x D x H | 220 x 321x 425 mm (8.7 x 12.6 x 16.7 in.) |
| Weight | 7.2 kg (15.9 lbs.) |

ALPS 50 V Microplate Heat Sealer

| Cat. No. | Description | No. per Case |
|----------|---|--------------|
| AB-1443A | ALPS 50 V Semi automated Microplate Heat Sealer | 1 |

ALPS Heat Sealer Accessories

| Cat. No. | Description | No. per Case |
|--------------|---|--------------|
| AB-0563/1000 | 96Well PCR Plate Carrier | 1 |
| AB-0592 | Foil Stripper | 1 |
| AB-0724 | 384-Well PCR Plate Carrier | 1 |
| AB-0827 | Standard Microplate Carrier | 1 |
| AB-1118 | 96Well (V) Conical Bottom Storage Plate Carrier | 1 |

Thermo Scientific ALPS 3000 Automated Microplate Heat Sealer



ALPS 3000 Automated Microplate Heat Sealer is a fast, compact heat sealer created for optimal robotic integration in high-throughput labs, yet allows manual, benchtop control.

details

- Compact footprint (165 x 405 mm) to conserve bench space
- Top-loaded seals are easily accessible

Fast, Easy-to-use

- Light (11.8kg / 26 lbs.)
- Seals are top-loading and easily accessible
- Rapid plate sealing action (6 seconds/plate) in either high-throughput robotic applications or benchtop, hand-fed operations
- Available with a variety of available heat seals to meet any laboratory application, including PCR, colorimetric, fluorescence, long-term storage, low temperature storage, piercing and resealing
- On-board touch screen operation for benchtop use and RS232 port with included ASCII programming parameters for robotic integration

Safe and Secure

- Sensors detect the presence of sealing tape and plate
- Air input allows automatic system shutoff to eliminate product waste, system hold-ups and potential injury

Sealing Flexibility

- Compatible with virtually any height microplate or block, including PCR plates

Warranty: 1-Year, in-factory warranty on parts and labor

The ALPS 3000 comes with 3 adapters to support a variety of standard microplates with various height skirts (2, 2.5, and 3 mm) and the 96-well PCR plate adapter (Cat. No. AB-0563/1000).

Certifications: CE Marked

ALPS 3000 Automated Microplate Heat Sealer

| Specifications | |
|--------------------------------|---|
| Dimensions W x D x H | 414 x 185 x 350 mm (16.3 x 7.3 x 13.8 in.) |
| Weight | 12 kg (26.5 lbs.) |
| Speed | 6 to 12 seconds per plate |
| Power Supply | 110-240 VAC, 50-60 Hz |
| Air Requirements | 50 liters per minute |
| Air Input Pressure | 5.5 bar (80psi) to 5.7 bar (87psi) |
| Sealing Temperature Range | Ambient to 200°C |
| Operating Temperature Range | 15° to 40°C |
| Sealing Plate Height, mm | 8 to 46 |

| Cat. No. | Description | No. per Case |
|----------|--|--------------|
| AB-3000 | ALPS 3000 Automated Microplate Heat Sealer | 1 |
| AB-0592 | Foil Stripper | 1 |

ALPS 3000 Automated Heat Sealer Accessories

| Cat. No. | Description | No. per Case |
|--------------|---------------------------|--------------|
| AB-0563/1000 | 96-well PCR plate adapter | 1 |

Thermo Scientific Heat Seals



Heat-sealed microplates are ideal for storage applications.

Advantages over other plate sealing methods include time and cost savings and sealing integrity. When heat sealing, the sealing material is first placed in position over the plate, which must have a raised rim around each well. Heat is applied evenly for several seconds, resulting in binding of the sealing material to the raised rim to achieve a complete seal. Heat sealing offers the capability of retrieving samples and then re-sealing the plate.

details

See table below for detailed description of each seal

Thermo Scientific Heat Seals are:

- Fast
- Safe for temperature-sensitive samples
- Designed for reliable performance with Thermo Scientific ALPS instruments, including the ALPS 3000, ALPS 25 and ALPS 50 V

For compatible heat sealers used with these products, see ALPS 25, ALPS 50 and ALPS 3000 Heat Sealers.

Heat Seals, Single Sheets

| Cat. No. | Plate Material Types | Description | Compatible with: | Dimensions, mm | Packaging |
|----------|----------------------|---|------------------|----------------|------------|
| AB-0559 | PP | Thermo Seal: Foil laminate; Very strong seal; Excellent chemical resistance; Recommended for use with DMSO The robust sealing option | ALPS 25 and 50V | 85 x 135 | 100 sheets |
| AB-0685 | PP | Clear Seal: Strong Clear polyester-polypropylene seal cannot be peeled or pierced; Optically transparent for sample inspection | ALPS 25 and 50V | 85 x 135 | 100 sheets |
| AB-0745 | PP, PE & CCC | Easy Peel: Foil laminate for long-term storage; good for low temperatures to -200°F | ALPS 25 and 50V | 85 x 135 | 100 sheets |
| AB-0757 | PP & PE | Easy Pierce: Easily pierced foil material for PP, PE and PCR; Accepts secondary foil application for re-sealing; Good chemical compatibility; Ideal for use with DMSO | ALPS 25 and 50V | 85 x 135 | 100 sheets |
| AB-0812 | PP, PS, PE & CCC | Diamond Seal: Clear polymer seal | ALPS 25 and 50V | 85 x 135 | 100 sheets |
| AB-1720 | PP & PE | Easy Pierce: 20 µm Thin foil for excellent pierceability, including multiple seals for repeated sealing; 85 X 135 mm sheets; For use with the ALPS 25 and ALPS 50V | ALPS 25 and 50V | 85 x 135 | 100 sheets |
| AB-1797 | PP, PS, & PE | Clear Seal: Thin, clear polymer seal; Pierceable; Non-conductive | ALPS 25 and 50V | 85 x 135 | 100 sheets |

Heat Seals, Rolls

| Cat. No. | Plate Material Types | Description | Compatible with: | Dimensions, mm x m | Packaging |
|----------|----------------------|---|------------------|--------------------|-----------|
| AB-3559 | PP | Thermo Seal: Foil laminate; Very strong seal; Excellent chemical resistance; Recommended for use with DMSO, the robust sealing option | ALPS 3000 | 78 x 370 | 1 roll |
| AB-3686 | PP | Clear Seal: Strong, clear polyester-polypropylene seal cannot be peeled or pierced; Optically transparent for sample inspection | ALPS 3000 | 78 x 610 | 1 roll |
| AB-3720 | PP & PE | Easy Pierce: 20 µm Thin foil for excellent pierceability, including multiple seals for repeated sealing | ALPS 3000 | 78 x 610 | 1 roll |
| AB-3738 | PP & PE | Easy Pierce: Easily pierced foil material for PP, PE and PCR; Accepts secondary foil application for re-sealing; Good chemical compatibility; Ideal for use with DMSO | ALPS 3000 | 78 x 610 | 1 roll |
| AB-3739 | PP, PE & CCC | Easy Peel: Foil laminate for long-term storage; Good for low temperatures to -200°F; Can be easily removed and a new seal applied | ALPS 3000 | 78 x 610 | 1 roll |
| AB-3797 | PP, PS, & PE | Clear Seal: Thin, clear polymer seal; Pierceable; Non-conductive; For Use with the ALPS 3000; 78 mm x 610 mm roll | ALPS 3000 | 78 x 610 | 1 roll |
| AB-3799 | PP, PS, PE & CCC | Diamond Seal: Clear polymer seal; Peelable seal with excellent optical clarity | ALPS 3000 | 78 x 370 | 1 roll |

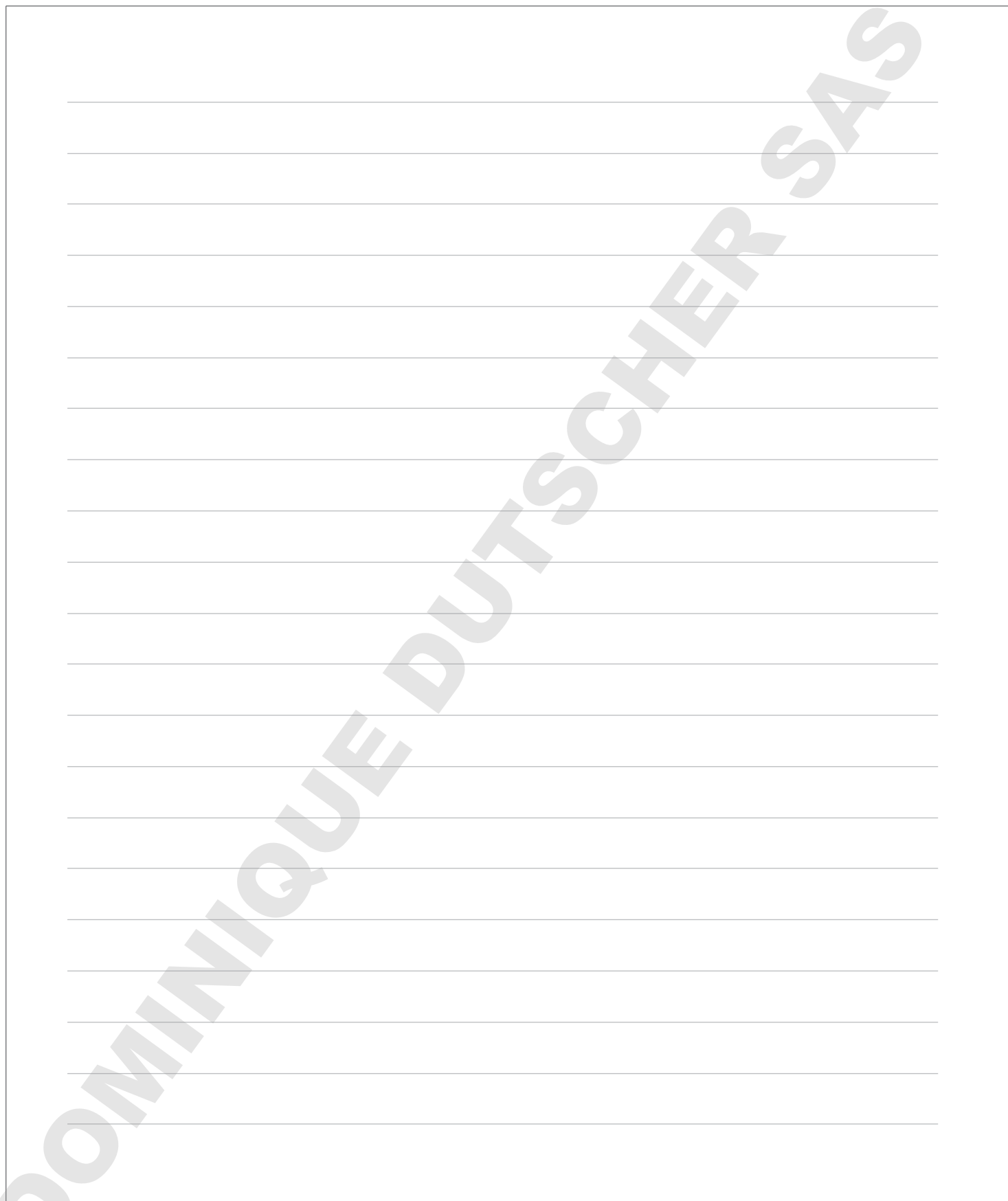

DOMINIQUE DUTSCHER SAS

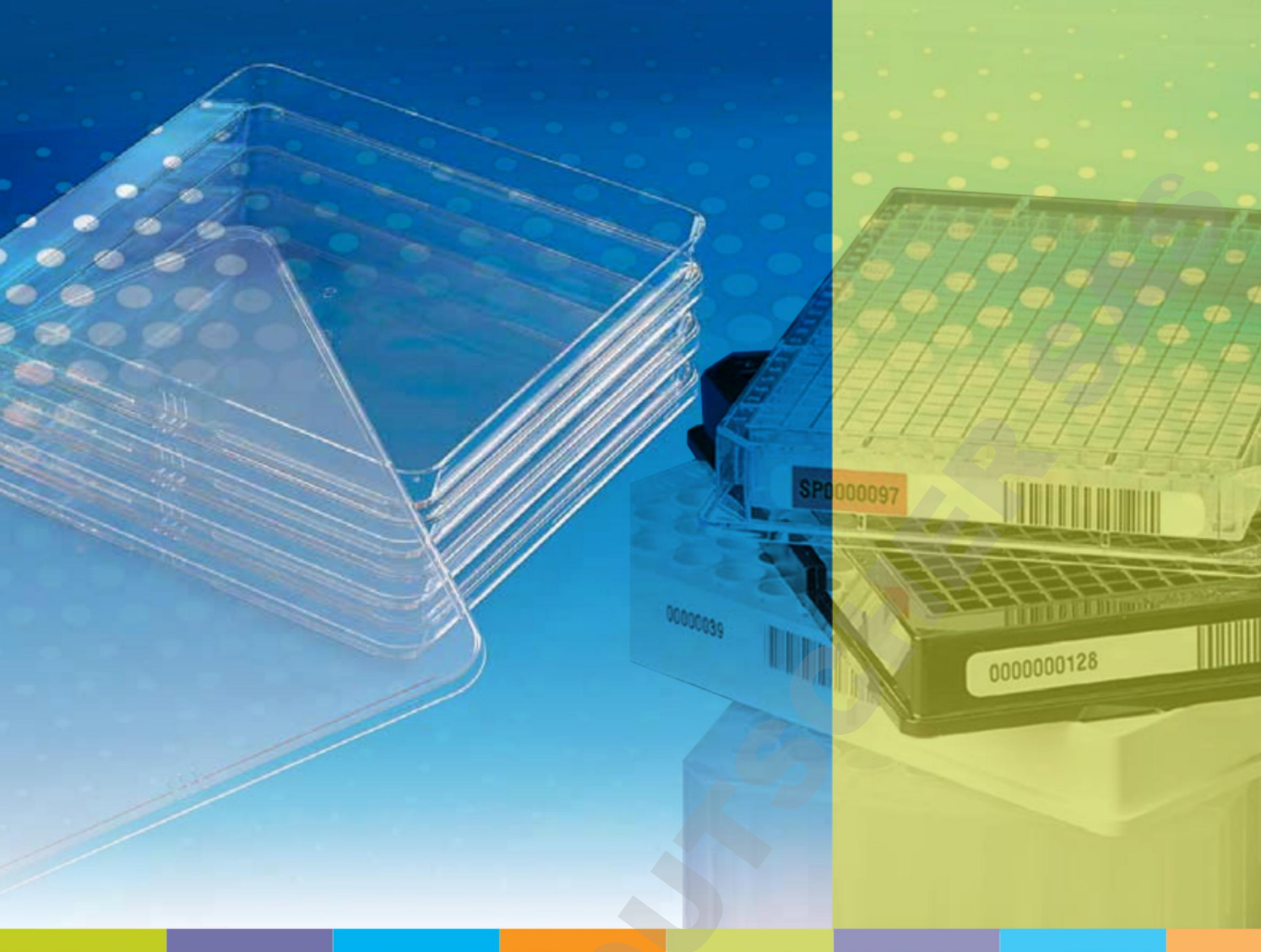

© 2014 Thermo Fisher Scientific Inc. All rights reserved. Excel and Microsoft are registered trademarks of Microsoft Corp. All other trademarks are the property of Thermo Fisher Scientific Inc. and its subsidiaries.

www.thermoscientific.com

ANZ: Australia: +61 1300 735 292; New Zealand: +64 0800 933 966

Asia: China: +86 400 650 5118; India: +91 22 6716 2200; India Toll-free: 800 22 8374

Japan: +81 3 5826 1616; Other Asian countries: +65 68729717

Europe: Austria: +43 1 801 40 0; Belgium: +32 53 73 42 41; Denmark: +45 4631 2000; France: +33 2 2803 2180

Germany: +49 6184 90 6940; Germany Toll-free: 08001 536 376; Italy: +39 02 02 95059 or +39 434 254 375

Netherlands: +31 76 571 4440; Nordic/Baltic countries: +358 9 329 100; Russia/CIS: +7 812 703 42 15

Spain/Portugal: +34 93 223 09 18; Switzerland: +41 44 454 12 12; UK/Ireland: +44 870 609 9203

North America: USA/Canada +1 585 586 8800; USA Toll-free: +1 800 625 4327

South America: USA sales support: +1 585 899 7198

Countries not listed: +49 6184 90 6940 or +33 2 2803 2180

CTLSPPPLATEGUIDE 0914

Thermo
SCIENTIFIC

Part of Thermo Fisher Scientific