



**Thermo Scientific  
Microplates Guide**

**superior performance**  
in virtually every application

DOMINIQUE DUTS

**Thermo**  
SCIENTIFIC



# sample integrity

## Thermo Scientific microplates

The quality and breadth of the Thermo Scientific™ line of multi-dishes, microplates, microplate accessories and microplate sealers are unmatched in the industry. Researchers around the world rely on our 55 years of experience manufacturing Thermo Scientific™ Nunc™ microplates, and regard Nunc quality as the standard by which all microplates are measured. Whether you're culturing individual cell lines or scaling up for high-throughput screening, or anything in between – there's a Nunc microplate for your needs.

The range of Thermo Scientific adhesive seals, heat seals and heat sealers offers reliable options for maintaining the integrity of your plate contents, allowing you to store your samples confidently. For added assurance in tracking stored samples, rely on Nunc custom barcoding to simplify your tracking and inventory management.

With so many variables in your research, don't let consumables get in the way of progress. Choose only Thermo Scientific products – the most reliable microplates and accessories available.

**For an online guide to help you select the best plate for your research, and to download complete specification drawings, visit: [thermoscientific.com/plateguide](http://thermoscientific.com/plateguide)**

**Download our app today to use your mobile device for a quick search, share information with colleagues and save your favorites in the “my lab” folder.**

**Visit the app store and search: *plate guide*.**

## Thermo Scientific Products:

<b>Assay Dishes/Multi dishes</b>		<b>Nunc Microplate Lids</b>	
Nunc BioAssay Dishes	8	Lids	46
Nunc Rectangular Dishes	9		
Nunc Glass Bottom Dishes	9	<b>Scanners/Storage Racks</b>	
Nunc OmniTray	10	Nunc Barcode Scanners	48
Nunc Immuno TSP	10	Nalgene Storage Racks for Microplates	49
<b>Nunc Multidishes</b>		Nunc Horizontal Microplate Plastic Storage Racks	49
Cell Culture Treated	11	Nunc Vertical Microplate Storage Racks	50
Nunclon Sphera Surface	12		
UpCell Surface	13	<b>Washers/Replication System/Reservoirs</b>	
Poly D-Lysine or Collagen I Coated	14	Nunc-Immuno Washers	51
Nunclon Vita Surface	15	Nunc Replication System	52
Bidite Products	16	Nalgene Disposable Polypropylene Robotic Reservoirs	53
Non-treated	17		
<b>96-Well Plates</b>		<b>Sealing</b>	
Nunc Edge 96-Well Plates	19	96-Well Cap Mats	54
Flat Bottom 96-Well Clear Polystyrene Plates	20	Nunc Adhesive Sealing Tapes	55
Flat Bottom 96-Well Black and White Polystyrene Plates	22	SuperSealer	56
Round Bottom 96-Well Clear Polystyrene Plates	24	ALPS25 Manual Heat Sealer	57
Conical Bottom 96-Well Clear Polystyrene Plates	26	ALPS50 VMicroplate Heat Sealer	58
96-Well UV Plates	27	ALPS3000 Automated Microplate Heat Sealer	59
Nunc C96-Well Clear Polystyrene Microplates	27	Heat Seals	60
Nunc 96-Well Optical-Bottom Plates with Polymer Base	28		
Nunc 96-Well Optical-Bottom Plates with Coverglass Base	29		
96-Well Polypropylene Plates	30		
96-DeepWell Polypropylene Plates	32		
Nunc 96-DeepWell Polystyrene Plates	34		
Nunc 96-Well Filter Plates	35		
<b>384-Well Plates</b>			
384-Well Polystyrene Plates	36		
Nunc 384-Well Shallow Well Standard Height Plates	38		
Nunc 384-Well Optical Bottom Plates	39		
384-Well Polypropylene Plates	40		
Nunc 384-ShallowWell Standard Height Polypropylene Microplates	41		
Nunc DeepWell 384-Well Plates	43		
<b>1536-Well Plates</b>			
Nunc 1536-Well High Base Microplates	44		
Nunc 1536-Well Microplates	45		

## Surface Selection Guide for Cell Based Assays

To help ensure the most flexible, reproducible and reliable results across every stage of cell culture, we offer an extensive range of products spanning a variety of formats, sizes and surfaces. The following charts will help guide product selection, with specific cell types and desired cell culture ranges in mind.

### Select Your Surface

Thermo Scientific Cell Culture Surfaces		Nunclon Delta	Nunclon Vita	Collagen I	Poly-D-Lysine	Nunclon Sphera	UpCell	Untreated Surface	
Cell Types	Hepatocytes	•	•	•			•		
	Endothelial Cells	•		•			•		
	Neuronal Cells	Neuronal Cells	•			•		•	
		Neurosphere					•		
	Epithelial Cells	•	•	•			•		
	Tumor Cells	•	•	•	•	•	•		
	Blood Cells	Macrophages, Dendritic Cells, Neutrophils	•					•	
		Lymphocytes	•						•
		Platelet	•		•			•	
	Stem Cells	MSC	•	•				•	
		HSC	•						
		ESC	•*	•**					
		EB							

\* Requires matrix coating.

\*\* Requires conditioned media from feeder cells and ROCK inhibitor.

### Distinction is our legacy. For more than 50 years,

Thermo Scientific cell culture products have been a cornerstone of quality and dependability among researchers and scientists worldwide.

Today, our cell culture portfolio is built on a framework of innovative surface technologies and formats that achieve optimal consistency and growth across a variety of cell types – representing traditional as well as stem cell lines.



# surface selection guide

Thermo Scientific Cell Culture Surfaces		Nunclon Delta	Nunclon Vita	Collagen I	Poly-D-Lysine	Sphera	UpCell	Untreated Surface	
Multidishes and Microplates	1.1-1.9/well Culture Area Range (cm <sup>2</sup> )	4-well	•					•	
		6-well	•	•	•	•	•	•	
		12-well	•				•	•	•
		24-well	•				•	•	•
		48-well	•				•	•	•
		96-well	•		•	•	•	•	•

Number of Wells	Throughput	Automation
1, 4, 6, 8, 12, 16, 24, 48	Low to medium	As needed
96	Moderate	Common
384, 1536	High to ultra-high	Necessary

Plate Type	Description	Material	Applications
Solid	Single molded plate, one piece with solid bottom	Polypropylene (PP) or Polystyrene (PS)	Cell culture, homogeneous assays, ELISA, fluorescence, luminescence, storage
Optical Bottom	Black or white upper structure with clear bottom	PS upper structure with polymer or glass base	Cell imaging and assays, fluorescence
Filter	96 well 1 mL plate with filters or binding membranes	PP plate with Polyethylene (PET) frit or frit plus glass fiber membrane	Filtration of cell debris and genomic DNA. Purification of plasmid DNA and PCR products

Well Abbreviation	Bottom Shape	Advantages
F	Flat Bottom	Optical imaging, cell culture
C	Rounded Corners and Flat Bottom	Advantages of flat bottom with efficient washing
U	Round Bottom	Optimal washing, mixing, examination of pellet
V	Conical Bottom	Precipitation, centrifugation, small volume recovery

Plate Color	Key Application
Clear	Colorimetric Assays, Cell Culture, ELISA
Black	Fluorescent Assays
Natural	Storage
White	Luminescent Assays
Red	Available Choice
Blue	Available Choice
Yellow	Available Choice

Material	Chemical Resistance	Binding Capacity	Plastic Characteristics	Applications
Polystyrene (PS)	Low	Low to very high depending on surface treatment	Hard, clear	Homogeneous assays, ELISA, cell culture, fluorescence, luminescence
Polypropylene (PP)	High	Very low	Softer, more opaque	Storage, fluorescence, luminescence

## Mechanism of Action

### Energy treatment

The energetic surface oxidation improves polystyrene surface hydrophilicity and results in generation of both hydroxyl and carboxyl functional groups. The presence of these hydrophilic groups facilitates the protein unfolding needed for cell attachment.

### Extracellular matrix (ECM) coating

Passive adsorption of biological materials such as ECM facilitates the adhesion of finicky cells by mimicking the action of basal lamina substrates on cell culture surfaces.

### Polymer graft

Covalent binding of polymers to polystyrene enables special functions to the cell culture surface (e.g. super-hydrophilic polymer prevents cells from adhering to Low Cell Binding and HydroCell surfaces; thermoresponsive polymer enables enzyme-free detachment of cells by reducing the external culture temperature).

### Untreated polystyrene

The smooth and hydrophobic polystyrene surface allows non-adherent cell culture at low cost.

## Choice of Surface



### Surface for passive binding

Schematic representation of the types of biomacromolecules, which can be bound to the available modified surfaces. Eg. if a lipid is to be bound, the hydrophobic surface Thermo Scientific<sup>™</sup> Nunc<sup>™</sup> PolySorp<sup>™</sup> is most suitable. Based on the physiochemical characteristics of the biomolecule to be immobilized, a surface can be chosen which is appropriate for robust binding. Thermo Scientific<sup>™</sup> Nunc<sup>™</sup> MaxiSorp<sup>™</sup> has the widest breadth applications, as it is capable of binding the greatest range of molecules.

#### Surface characteristics:

- Adsorb larger biomolecules
- Different molecular orientations are possible
- A variety of surfaces are available for performance optimization



### Covalent coupling surfaces

The diagram shows the available surface modifications for directed binding of target biomolecules. In the case of the Thermo Scientific<sup>™</sup> Immobilizer<sup>™</sup> Amino and Thermo Scientific<sup>™</sup> Covalink<sup>™</sup>, a strong covalent bond is formed with the biomolecule being immobilized at the surface. The biomolecule must possess the correct functional group for covalent coupling.

The diagram shows the available surface modifications for directed binding of target biomolecules.



### Affinity capture surfaces

The diagram shows the available surface modifications for directed binding of target biomolecules.

## Thermo Scientific Nunc BioAssay Dishes Square



Thermo Scientific™ Nunc™ Square BioAssay Dishes are useful as incubation chambers for in-situ hybridization and suitable for agar diffusion assays.

Used for culturing bacteria, yeast and fungi. Also suitable as a moisture chamber for incubation of Thermo Scientific Nunc Microwell Plates.

### details

- Optically-clear
- Large growth area
- Low profile design fits robotic instruments
- Designed for genomic screening and colony picking
- Untreated
- Sterile
- Supplied with lid

### Nunc BioAssay Dishes

Cat. No.	Description	Working Volume, mL	L x W x H mm	Working Vol., mL	Surface Area, cm <sup>2</sup>	Nb. per Pack	Nb. per Case
240835	Standard Height BioAssay Dish	225	245 x 245 x 25	225	500	4	16
240845	Low Profile BioAssay Dish	215	241 x 241 x 20	215	478	5	20



## Thermo Scientific Nunc Rectangular Dishes



Nunc Rectangular Dishes have ANSI standard dimensions and are optimized for robotics.

The non-treated surface is ideal for molecular biology applications.

### details

#### Rectangular Dishes 1-, 4- and 8-well

- 1-well dish is ideal for HTS Petri dish applications
- 4- and 8-well dishes are ideal for assay compartmentalization, probe multiple gene sub-set
- 4-well dish holds four glass slides for storage

#### 1-Well Format

- Convenient plate format for cell culture
- HTS Petri dish applications

#### 4- and 8-Well Formats

- Assay compartmentalization
- Probe multiple gene subsets
- Wash Western blot strips
- Useful in all areas of cell culture, including scale-up and cloning

**Compliance:** All Nunc microplates meet the recommendation of American National Standards Institute (ANSI).

### Nunc Rectangular Dishes

Cat. No.	Total Vol., $\mu\text{L}$	Wells	L x W, mm	Sterile	Lid	No. per Pack	No. Per Case
267060	90	1	128 x 86	Yes	Yes	10	100
267061	22	4	128 x 86	Yes	Yes	10	100
267062	11	8	128 x 86	Yes	Yes	10	100

## Thermo Scientific Nunc Glass Bottom Dishes



Nunc Glass Bottom Dishes give you the flexibility to convert your culture device into an imaging device. This means you keep the same seeding density, media volume and culture conditions.

The Nunc glass bottom dish combines the convenience of a standard 35 mm cell culture dish with the imaging benefits of coverglass to provide the optimum optical characteristics required for high-magnification microscopy and confocal image analysis.

### details

Ideal for observation at high magnification:

- Fluorescence, phase contrast, and confocal microscopy
- Live cell imaging
- Differential interference contrast microscopy
- Fluorescence in situ hybridization (FISH)

### Nunc Glass Bottom Dishes

Cat. No.	Description	No./Pack	No./Case
150680*	Nunc Glass Bottom Dish, 12 mm	1	20
150682	Nunc Glass Bottom Dish, 27 mm	1	20

\* Glass Bottom Dishes are not available in Japan

## Thermo Scientific Nunc OmniTray



Nunc OmniTrays are ideal for screening libraries, DNA hybridization, standard petri dish techniques and bacterial growth.

### details

- Clear polystyrene has excellent optical properties making it ideal for optical measurements and colony counting; can be frozen at -20°C
- Untreated polystyrene is hydrophobic and is suited for growth of suspension cultures that can proliferate and grow without attachment
- Untreated surfaces are ideal for adding coatings in your lab
- Cell Culture Treated: The Thermo Scientific™ Nunclon™ Delta cell culture treated surface is a hydrophilic surface that promotes cell attachment and growth
- Optical clarity makes colonies easy to see

### Nunc OmniTray acts as:

- Holder for membrane when dot blotting; container for hybridization and washing steps; storage container for membranes

**Recommended for:** Dot blotting, denaturation/hybridization/washing, bacterial growth, membrane storage and microplate inoculation when used with TSP lid.

**Compliance:** All Nunc microplates meet the recommendation of American National Standards Institute (ANSI).

### Nunc OmniTray

Cat. No.	Surface	Well Design	Color	Total Vol., $\mu\text{L}$	Working Vol., mL	Sterile	Lid	No. per Pack	No. per Case
140156*	Cell Culture	Rectangular	Clear	90	35	Yes	Yes	10	90
165218	Cell Culture	Rectangular	Clear	90	35	Yes	Yes	10	60
242811	Non-Treated	Rectangular	Clear	90	35	Yes	Yes	10	60
264728	Non-Treated	Rectangular	Clear	90	35	Yes	Yes	10	90

\* Enhanced rectangular area ideal for automated picking and viewing system



## Thermo Scientific Nunc Immuno TSP

Thermo Scientific™ Nunc™ Immuno™ TSP lid is ideal for Hybridoma screening.

- Ideal for screening of hybridoma cultures for antibody production
- For Hybridoma screening mounted in the OmniTray
- Uniform adsorption properties
- 96 Pin lid for bacterial inoculations of 96-well plates

### Nunc-Immuno TSP

Cat No	Surface	Color	Total surface area, $\text{mm}^2$	Sterile	Lid	No. per Pack	No. per Case
445497	Non-treated	Clear	95	Yes	No	1	50

## Thermo Scientific Nunc Multidishes

### Cell Culture Treated



Nunc Cell Culture Multidishes are Thermo Scientific™ Nunclon™ Delta treated.

This proprietary surface modification promotes maximum adhesion for a broad range of cell types and ensures optimum performance.

#### details

- Flat well bottom and stackable
- Raised well rims lower risk of cross contamination
- Excellent optical quality
- Alphanumeric codes for well identification
- Sterilized and certified to be non-pyrogenic

#### Round Well Styles

- Feature vented lids for gas exchange
- Recessed areas around wells act as a reservoir to reduce evaporation from wells
- Lids with notched corners allow for easy orientation and reduce cross contamination

#### Rectangular Well Styles

- Large culture area
- Accepts standard glass cover slips: 24 × 60 mm for 4-well plate; and 22 × 22 mm for 8-well plate

**Certifications:** Offered with certificate of traceability and quality (one certificate per case).

#### Nunc Multidishes

Cat. No.	Surface Culture	No of Wells	O.D., mm	Well Shape	Culture Area, cm <sup>2</sup>	Working Vol., mL	No. per Pack	No. per Case
176740	Nunclon Delta	4	66 x 66	Round	1.9	1	4	120
167063	Nunclon Delta	4	128 x 86	Rectangular	21.8	5	10	100
140675	Nunclon Delta	6	128 x 86	Round	9.6	3	1	75
140685	Nunclon Delta	6	128 x 86	Round	9.6	3	5	85
167064	Nunclon Delta	8	128 x 86	Rectangular	10.5	3	10	100
150628	Nunclon Delta	12	128 x 86	Round	3.5	2	1	75
142475	Nunclon Delta	24	128 x 86	Round	1.8	1	1	75
142485	Nunclon Delta	24	128 x 86	Round	1.8	1	5	85
150687	Nunclon Delta	48	128 x 86	Round	1.1	0.5	1	75
152640	Nunclon Delta	48	128 x 86	Round	1.1	0.5	5	85

► To request certificates online, visit [www.thermoscientific.com/certificates](http://www.thermoscientific.com/certificates)

## Thermo Scientific Nunc Multidishes and Microplates Nunclon™ Sphera™ Surface



Make your most valuable work your best work. Thermo Scientific™ Nunclon™ Sphera™ Microplates feature a superior cell culture surface with demonstrated performance that elevates stem cell and cell culture research. Offered in round and flat-bottom 96-well formats.

### details

#### Optimizes spheroid formation

- Allows cells to grow in suspension with virtually no cell attachment
- Supports many different cell types and their ability to generate spheroids
- Enables consistent, repeatable cell growth

#### Ideal for growing 3D cancer cultures

- Minimizes variability and supports the consistent formation of cancer spheroids that simulate the 3D structures of tumor growth, providing a better model system for studying tumor cell progression and efficacy of anticancer agents *in vitro*

#### Promotes formation of embryoid bodies (EB)

- Demonstrates superior quality for embryoid body formation of pluripotent stem cells with minimal spontaneous differentiation
- Resultant cells able to differentiate into all three germ layers

### Nunc Multidishes

Cat. No.	Surface	Well Design	Color	Culture Area, cm <sup>2</sup>	Sterile	Lid	No. per Pack	No. per Case
174932	Sphera	6 F	Clear	9.6	Yes	Yes	1	7
174931	Sphera	12 F	Clear	3.5	Yes	Yes	1	7
174930	Sphera	24 F	Clear	1.9	Yes	Yes	1	7
174925	Sphera	96 U	Clear	0.36	Yes	Yes	1	8
174927	Sphera	96 F	Clear	0.33	Yes	Yes	1	8
174929	Sphera	96 U	Clear	0.36	Yes	Yes	5	50

## Thermo Scientific Nunc Multidishes UpCell Surface



Nunc Multidishes with Thermo Scientific™ UpCell™ Surface feature a temperature-responsive surface that supports non-enzymatic harvesting of adherent cells for preservation of cell viability and surface proteins.

Simply transfer the culture to room temperature and cells can be collected in suspension or in the form of a “cell sheet”.

Traditional cell harvesting by enzymatic and mechanical methods often compromise the integrity of surface proteins and the viability of harvested cells.

By contrast, the UpCell Surface allows cell harvesting by simply reducing the temperature of the cell culture to below 32°C without the need of enzymes, resulting in highly viable cells with intact cell surface proteins.

### details

- No trypsinization – preserve cell surface proteins
- No physical force – get high cell viability
- Perfect for culture passaging, single-cell analyses and cell transplantation research
- 6-well multidish comes with supportive membranes that enable harvesting of cell sheets and creations of 3-D tissue models
- Minimal manual manipulation

**Recommended for:** Culture passaging, single-cell analyses, cell transplantation research, 3D tissue models.

### Nunc Multidishes

Cat. No.	Well Design	Supportive membrane (for harvesting “cell sheet”)	Color	Membrane	Culture Area, cm <sup>2</sup>	Suggested Working Vol., mL	Sterile	Lid	No. per Pack	No. per Case
174901	6 F	Included	Clear	Yes	9.6	3	Yes	Yes	1	6
174900	12 F	Not Included	Clear	No	3.5	2	Yes	Yes	1	6
174899	24 F	Not Included	Clear	No	1.9	1	Yes	Yes	1	6
174898	48 F	Not Included	Clear	No	1.1	0.5	Yes	Yes	1	6
174897	96 F	Not Included	Clear	No	0.33	0.2	Yes	Yes	1	8

Thermo Scientific Nunc Multidishes  
Poly-D-Lysine or Collagen I Coated



Nunc Multidishes with extracellular matrix coating enhance cell attachment to the culture surface. Ideal for culturing finicky cells.

details

- Ideal for culturing finicky cells that do not attach to regular cell culture treated surface
- Poly-D-Lysine is a chemically synthesized animal-free coating material
- Sterile and non-pyrogenic

Nunc Multidishes

Cat. No.	Surface Coating	Working Vol., mL	Culture Area, cm <sup>2</sup>	No. of Wells	No. per Pack	No. per Case
152035	Poly-D-Lysine coated	3	9.6	6	5	20
152034	Collagen I, rat tail	3	9.6	6	5	20

## Thermo Scientific Nunc Multidish 6 Nunclon Vita



Thermo Scientific™ Nunclon™ Vita™ is a unique energy-treated surface that enables growth of stem cells and other temperamental cells without matrix coatings or feeder layers.

When combined with conditioned media, supplemented with a ROCK inhibitor, Nunclon Vita surface supports attachment and expansion of human pluripotent stem cells.

Nunclon Vita surface supports attachment and growth of finicky cells (e.g. HEK 293, MSC) in the absence of feeder layers and matrix coatings. In conditioned media, supplemented with ROCK inhibitor, human ESC can be cultured directly on the Nunclon Vita surface for more than 10 passages while maintaining normal karyotype and pluripotency.

### details

- Animal component-free surface
- Consistent performance from lot to lot
- Supports attachment and growth of temperamental cells (e.g. HEK 293, MSC)
- Supports attachment and expansion of human pluripotent stem cells in conditioned media containing ROCK inhibitor
- Allows non-enzymatic dissociation of human pluripotent stem cells with removal of ROCK inhibitor

### Nunc Multidish 6

Cat. No.	Description	Working Vol., mL	Culture Area, cm <sup>2</sup> /well	No. of Wells	Bottom Shape	Sterile	No. per Pack	No. per Case
145380	Nunclon Vita Multidish 6	3	9.6	6	Flat	Yes	1	4

## Thermo Scientific Biolite Cell Culture Products



Thermo Scientific™ BioLite™ Cell Culture Products deliver economical performance for your general cell culture procedures.

BioLite Cell Culture products are designed for your general cell culture research, an ideal choice when economy and quality matter.

This product line includes a limited range of sterile flasks covering surface areas from 25 cm<sup>2</sup> to 175 cm<sup>2</sup>; dishes from 35 mm to 150 mm, and 6- to 96-well dishes.

BioLite products offer a cell-adherent surface and are non-pyrogenic and non-cytotoxic.

### details

- Cell culture treated
- Sterile
- Non-pyrogenic
- USP Class VI and non-cytotoxic

Biolite Multidishes and Microwell Plate

Cat. No.	Well Design	Well Dia., mm	Outer L x W mm	Color	Culture Area, cm <sup>2</sup> /well	Suggested Working Vol., mL	Lid	Sterile	No. per Pack	No. per Case
130184	6	35	127.6 x 85.4	Clear	9.6	3	Yes	Yes	1	50
130185	12	22.1	127.6 x 85.4	Clear	3.8	2	Yes	Yes	1	50
130186	24	15.6	127.6 x 85.4	Clear	1.9	1	Yes	Yes	1	50
130187	48	9.75	127.6 x 85.4	Clear	0.75	0.5	Yes	Yes	1	50
130188	96F	6.4	127.6 x 85.4	Clear	0.32	0.2	Yes	Yes	1	50



## Thermo Scientific Nunc Multidishes

Non-treated



Nunc Multidishes are non-treated and sterile for suspension of cell cultures and have excellent optical properties.

### details

- Non-treated, sterile polystyrene multidishes for suspension cell culture
- Flat-bottom round wells, with lid
- Raised-well rims lower the risk of cross-contamination
- Lid with notched corners for good fit and easy orientation
- Non-pyrogenic

**Includes:** Lids

### Nunc Multidishes

Cat. No.	No. of Wells	Culture Area cm <sup>2</sup>	Working Vol., mL	O.D., L x W, mm	No. per Pack	No. per Case
179820	4	1.9	1	66 x 66	4	120
150239	6	9.6	3	128 x 86	1	75
150200	12	3.5	2	128 x 86	1	75
144530	24	1.9	1	128 x 86	1	75
150787	48	1.1	0.5	128 x 86	1	75

## INNOVATIVE DESIGN MINIMIZES EVAPORATION

# Protect Your Cells Against “Edge Effect”

## Thermo Scientific Nunc Edge 96-Well Plates

Few options exist to minimize evaporation during extended culturing, which often most affects cells at the plate's outer edge. One common method is to leave perimeter wells unused – but that sacrifices almost 40% of the entire plate capacity.

Thermo Scientific™ Nunc™ Edge Plates have a built-in moat surrounding the perimeter wells that provides extra humidity and reduces evaporation from the entire plate.

▶ To learn more about the advantages of Nunc Edge Plates, visit [www.thermoscientific.com/edgeplate](http://www.thermoscientific.com/edgeplate)

In a comparison to standard plates, Nunc Edge plates significantly reduced evaporation during 7-day and 14-day incubation trials:

### STANDARD PLATE/7-DAY TRIAL



### NUNC EDGE PLATE/7-DAY TRIAL



### 14-DAY COMPARISON



## Thermo Scientific Nunc Edge 96-Well Plate



	mm
<b>Total height of plate</b>	<b>14.4</b>
H2 Vertical distance from inside well bottom to resting plane	3.0
H3 Inside depth of well	11.4
H4 Vertical distance from external well bottom to resting plane	2.0
H5 Height of flange on the short side	2.6
D1 Well diameter, top	7.1
D2 Well diameter, bottom	6.7
F1 Depth of flange	1.9



The Thermo Scientific™ Nunc™ Edge™ 96-Well Plate has a unique design that minimizes plate evaporation.

Fill each moat section with 1.7 mL sterile water or media; the large evaporation reservoirs eliminate well-to-well variability while dramatically reducing the overall evaporation rate to <2% after 7 days of incubation. In addition to the evaporation barrier, the Edge plate is engineered for optical superiority allowing your automated imaging systems to operate efficiently.

### details

- Clear polystyrene has excellent optical properties making it ideal for optical measurements
- Untreated polystyrene is hydrophobic and is suited for growth of suspension cultures that can proliferate and grow without attachment.
- Untreated surfaces are ideal for adding coatings in your lab
- Cell Culture Treated: The Nunclon Delta cell culture treated surface is a hydrophilic surface that promotes cell attachment and growth
- Customized bar coding is available
- Working volume: 50-250  $\mu\text{L}$ /well
- Total well volume: 400  $\mu\text{L}$

### Reduced Edge Effect

- Virtually eliminates evaporation in lengthy incubations
- Use all 96 wells with fewer concerns of edge effect

### Low Evaporation Permits Full-plate Results

- Unique design minimizes plate evaporation
- Large evaporative buffer zones eliminate well-to-well variability
- Overall plate evaporation rate reduced to <2% after seven days of incubation
- Perimeter moat can be filled with 1.7 mL sterile  $\text{H}_2\text{O}$  or media

### Optical Properties are Critical

- Clear plates are engineered for optical superiority
- Low background fluorescence
- Extreme well flatness
- Ideal for image-based high content applications like measuring primary neuron cultures

**Compliance:** All Nunc microplates meet the recommendation of American National Standards Institute (ANSI).

### Nunc Edge 96-Well Plate

Cat. No.	Surface	Well Design	Color	Total Vol., $\mu\text{L}$	Sterile	Lid	No. per Pack	No. per Case
167311	Cell Culture	96 F	Clear	400	Yes	No	10	160
167314	Cell Culture	96 F	Clear	400	Yes	Yes	1	50
267312	Non-treated	96 F	Clear	400	No	Yes	10	160
267313	Non-treated	96 F	Clear	400	Yes	Yes	1	50

## Thermo Scientific Flat Bottom 96-well Clear Polystyrene Plates



Flat bottom 96-well Polystyrene Plates are optimized for robotics, automated readers and liquid handling systems.

Clear 96-well microplates are used for cell-based, binding and colorimetric assays. The flat bottom is ideal for microscopic and optical measurements. Our plates are high quality for consistent and reliable results

### details

- Clear polystyrene has excellent optical properties making it ideal for optical measurements
- Untreated polystyrene is hydrophobic and is suited for growth of suspension cultures that can proliferate and grow without attachment
- Untreated surfaces are ideal for adding coatings in your lab
- Cell Culture Treated: The Nunclon Delta cell culture treated surface is a hydrophilic surface that promotes cell attachment and growth
- Plates are optimized for robotics, plate readers and liquid handlers
- Working volume: 50-250  $\mu\text{L}$ /well

**Compliance:** All Thermo Scientific microplates meet the recommendation of American National Standards Institute (ANSI).

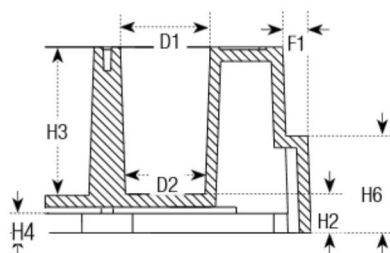

	mm
<b>Total height of plate</b>	<b>14.4 ± 0.2</b>
H2 Vertical distance from inside well bottom to resting plane	3.0
H3 Inside depth of well	11.4
H4 Vertical distance from external well bottom to resting plane	1.9
H5 Height of flange on the short side	2.4
H6 Height of flange on the long side	7.4
D1 Well diameter, top	7.0
D2 Well diameter, bottom	6.2
F1 Depth of flange	1.7

## Flat Bottom 96-well Clear Polystyrene Plates

Cat. No.	Surface	Well Design	Color	Total Vol., $\mu$ L	Sterile	Lid	No. Per Pack	No. Per Case
152038	Collagen I	96 F	Clear	400	--*	Yes	5	20
152039	Poly-D-Lysine	96 F	Clear	400	--*	Yes	5	20
156545**	Cell Culture	96 F	Clear	400	Yes	Nb	10	180
161093**	Cell Culture	96 F	Clear	400	Yes	Yes	10	160
167008**	Cell Culture	96 F	Clear	400	Yes	Yes	1	50
168055**	Cell Culture	96 F	Clear	400	Yes	Nb	1	50
174897	LpCell	96 F	Clear	400	Yes	Yes	1	8
174927	Sphera	96 F	Clear	400	Yes	Yes	1	8
243656	Non-Treated	96 F	Clear	400	Yes	Yes	6	108
260836	Non-Treated	96 F	Clear	400	Nb	Nb	10	180
260844*	Non-Treated	96 F	Clear	400	Nb	Nb	10	180
260860	Non-Treated	96 F	Clear	400	Yes	Yes	10	160
260887*	Non-Treated	96 F	Clear	400	Yes	Yes	10	160
260895	Non-Treated	96 F	Clear	400	Nb	Yes	10	160
266120	Non-Treated	96 F	Clear	400	Yes	Yes	25	100
269620	Non-Treated	96 F	Clear	400	Nb	Nb	5	60
269787	Non-Treated	96 F	Clear	400	Yes	Nb	1	50
9205	Non-Treated	96 F-Square Well	Clear	330	Nb	Nb	50	50
3355	Immulon 1 B	96 F	Clear	330	Nb	Nb	10	50
3455	Immulon 2 HB	96 F	Clear	330	Nb	Nb	10	50
3855**	Immulon 4 HBX	96 F	Clear	330	Nb	Nb	10	50
436006	Immobilizer Amino	96 F	Clear	400	Nb	Nb	5	30
436014	Immobilizer Streptavidin	96 F	Clear	400	Nb	Nb	1	15
436024	Immobilizer Nickel-Chelate	96 F	Clear	400	Nb	Nb	1	15
436032	Immobilizer Gultathione	96 F	Clear	400	Nb	Nb	1	15
439454**	MaxiSorp	96 F	Clear	400	Nb	Nb	5	60
442404	MaxiSorp	96 F	Clear	400	Nb	Nb	5	60
456529	PolySorp	96 F	Clear	400	Nb	Nb	10	180
456537**	MaxiSorp	96 F	Clear	400	Nb	Nb	10	180
460984/**	MaxiSorp	96 F	Clear	400	Nb	Nb	10	180
467320	MediSorp	96 F	Clear	400	Nb	Nb	5	60
467340	MultiSorp	96 F	Clear	400	Nb	Nb	5	60
475094	PolySorp	96 F	Clear	400	Nb	Nb	5	60
9502227	Universal Binding	96 F	Clear	450	Nb	Nb	25	50
95029330	Enhanced Binding	96 F	Clear	450	Nb	Nb	25	50
95029780	Universal Binding	96 F	Clear	450	Yes	Yes	1	40

\* Produced in a clean environment + Barcoded, 7-digit Code, 39 alphanumeric label, short left side \*\* Certified

u For custom barcoded plates, visit  
[www.thermoscientific.com/barcodeconfigurator](http://www.thermoscientific.com/barcodeconfigurator)

## Thermo Scientific Flat Bottom 96-well Black and White Polystyrene Plates



Flat-bottom 96-well Black and White Polystyrene Plates are optimized for robotics, plate readers and liquid handling systems.

Our plates are high quality for consistent and reliable results.

### details

- Background, autofluorescence and crosstalk are reduced when you use Nunc Black or White microplates
- Black microplates are recommended for fluorescence measurements with minimum back-scattered light and background fluorescence
- White microplates are recommended for luminescence measurements with maximum reflection and minimal autoluminescence
- Cell Culture Treated: The Nunclon Delta Cell Culture treated surface is a hydrophilic surface that promotes cell attachment and growth
- Working volume range: 50 to 250  $\mu\text{L}$ /well

**Compliance:** All Thermo Scientific microplates meet the recommendation of American National Standards Institute (ANSI), (ANSI/SBS 1-2004).

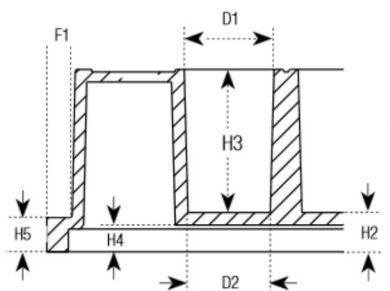

	mm
<b>Total height of plate</b>	<b>14.5 ± 0.3</b>
H2 Vertical distance from inside well bottom to resting plane	3.6
H3 Inside depth of well	11.2
H4 Vertical distance from external well bottom to resting plane	2.1
H5 Height of flange	2.7
D1 Well diameter, top	7.05
D2 Well diameter, bottom	6.55 ± -0.1
F1 Depth of flange	2.0

### Flat Bottom 96-well Black and White Polystyrene Plates

Cat. No.	Surface	Well Design	Color	Total Vol., $\mu\text{L}$	Sterile	Lid	No. per Pack	No. Per Case
136101**	Cell Culture	96 F	White	400	Yes	Yes	1	50
136102**	Cell Culture	96 F	White	400	Yes	Yes	10	160
137101**	Cell Culture	96 F	Black	400	Yes	Yes	1	50
137103**	Cell Culture	96 F	Black	400	Yes	Yes	10	160
236105	Non-Treated	96 F	White	400	Yes	Yes	1	50
236107	Non-Treated	96 F	White	400	Yes	Yes	10	160
236108	Non-Treated	96 F	White	400	No	No	10	180
237105	Non-Treated	96 F	Black	400	Yes	Yes	1	50
237107	Non-Treated	96 F	Black	400	Yes	Yes	10	160
237108	Non-Treated	96 F	Black	400	No	No	10	180

\*\* Certified

Cat. No.	Surface	Well Design	Color	Total volume, μL/well	Sterile	Lid	No. per Pack	No. per Case
436007	Immobilizer Amino	96 F	White	400	Nb	Nb	5	30
436008	Immobilizer Amino	96 F	Black	400	Nb	Nb	5	30
436015	Immobilizer Streptavidin	96 F	White	400	Nb	Nb	1	15
436016	Immobilizer Streptavidin	96 F	Black	400	Nb	Nb	1	15
436027	Immobilizer Nickel-Chelate	96 F	Black	400	Nb	Nb	1	15
436033	Immobilizer Gutathione	96 F	White	400	Nb	Nb	1	15
436034	Immobilizer Gutathione	96 F	Black	400	Nb	Nb	1	15
436110	MaxiSorp	96 F	White	400	Nb	Nb	10	80
436111	PolySorp	96 F	White	400	Nb	Nb	10	80
437111	MaxiSorp	96 F	Black	400	Nb	Nb	10	80
437112	PolySorp	96 F	Black	400	Nb	Nb	10	80
7571	Microtite 1+	96 F	White	330	Nb	Nb	10	50
7572	Microtite 2+	96 F	White	330	Nb	Nb	10	50
7417-12	Microtite 2+	96 F	White	330	Nb	Nb	50	50
7605	Microfluor 1	96 F	Black	330	Nb	Nb	10	50
7705	Microfluor 1	96 F	White	330	Nb	Nb	10	50
7805	Microfluor 2	96 F	Black	330	Nb	Nb	10	50
7905	Microfluor 2	96 F	White	330	Nb	Nb	10	50
9502867	Universal Binding	96 F	Black	450	Nb	Nb	25	50
9502887	Universal Binding	96 F	White	450	Nb	Nb	25	50

To request certificates online, visit  
[www.thermoscientific.com/certificates](http://www.thermoscientific.com/certificates)

## Thermo Scientific Round Bottom 96-well Polystyrene Plates



Round Bottom (U) 96-well Polystyrene Plates are optimized for robotics, automated readers and liquid handling systems.

96-well round (U) bottom microplates are ideal for agglutination assays.

### details

- Clear polystyrene has excellent optical properties making it ideal for optical measurements
- Untreated polystyrene is hydrophobic and is suited for growth of suspension cultures that can proliferate and grow without attachment
- Untreated surfaces are ideal for adding coatings in your lab
- Cell Culture Treated: The Nunclon Delta cell culture treated surface is a hydrophilic surface that promotes cell attachment and growth
- Plates are optimized for robotics, plate readers and liquid handlers
- Working volume: 50 to 250  $\mu\text{L}$ /well

**Compliance:** All Thermo Scientific microplates meet the recommendation of American National Standards Institute (ANSI).

	mm
<b>Total height of plate</b>	<b>14.5 <math>\pm</math> 0.1</b>
H2 Vertical distance from inside well bottom to resting plane	4.2
H3 Inside depth of well	10.2
H4 Vertical distance from external well bottom to resting plane	2.8
H5 Height of flange on the short side	2.4
H6 Height of flange on the long side	7.5
D1 Well diameter, top	7.1
D2 Well diameter, bottom	Round bottom
F1 Depth of flange	1.7





## Round Bottom 96-well Polystyrene Plates

Cat. No.	Surface	Well Design	Color	Total Vol. $\mu$ L/well	Sterile	Lid	Nb. per Pack	Nb. per Case
3555	Immulon 1 B	96 U	Clear	280	Nb	Nb	10	50
3655	Immulon 2 HB	96 U	Clear	280	Nb	Nb	10	50
449824	MaxiSorp	96 U	Clear	300	Nb	Nb	5	60
475434	PolySorp	96 U	Clear	300	Nb	Nb	5	60
143761**	Cell Culture	96 U	Clear	300	Yes	Nb	1	50
163320	Cell Culture	96 U	Clear	300	Yes	Yes	1	50
168136**	Cell Culture	96 U	Clear	300	Yes	Yes	10	160
174925	Sphera	96 U	Clear	300	Yes	Yes	1	8
262146	Non-Treated	96 U	Clear	300	Nb	Nb	135	135
262162	Non-Treated	96 U	Clear	300	Yes	Nb	1	50
268152	Non-Treated	96 U	Clear	300	Nb	Nb	10	180
268200	Non-Treated	96 U	Clear	300	Yes	Yes	10	160
2205	Non-Treated	96 U-Square Well	Clear	400	Nb	Nb	50	50
174929	Sphera	96 U	Clear	300	Yes	Yes	5	50

\*\*Certified



## Thermo Scientific Conical Bottom 96-well Polystyrene Plates



Nunc V96 Well Clear Polystyrene Microplates are optimized for robotics, automated readers and liquid handling systems.

Conical bottom (V) 96-well microplates are ideal for sample recovery. Applications include: antibiotic screens, serological tests, storing, screening compounds and DNA libraries

### details

- Clear polystyrene has excellent optical properties making it ideal for optical measurements
- Plates are optimized for robotics, plate readers and liquid handlers
- Customized bar coding is available
- Working volume range: 50 to 250  $\mu\text{L}$ /well

**Compliance:** All Thermo Scientific microplates meet the recommendation of American National Standards (ANSI).



	mm
<b>Total height of plate</b>	<b>14.4 <math>\pm</math> 0.1</b>
H2 Vertical distance from inside well bottom to resting plane	4.6
H3 Inside depth of well	9.8
H4 Vertical distance from external well bottom to resting plane	2.8
H5 Height of flange	2.7
D1 Well diameter, top	6.8
D2 Well diameter, bottom	V-shaped
F1 Depth of flange	1.2

### Conical Bottom 96-well Polystyrene Plates

Cat. No.	Surface	Well Design	Color	Total Vol., $\mu\text{L}$	Sterile	Lid	No. per Pack	No. per Case
249570	Non-Treated	96 V	Clear	300	No	No	10	180
249662	Non-Treated	96 V	Clear	300	Yes	No	1	50
249935	Non-Treated	96 V	Clear	300	Yes	Yes	10	80
249940	Non-Treated	96 V	Clear	300	Yes	No	10	80
249952	Non-Treated	96 V	Clear	300	Yes	Yes	10	160
277143*	Non-Treated	96 V	Clear	300	Yes	Yes	1	50
2605	Non-Treated	96 V-Square Well	Clear	280	No	No	50	50

\* Not available in the Americas

► For custom barcoded plates, visit  
[www.thermoscientific.com/barcodeconfigurator](http://www.thermoscientific.com/barcodeconfigurator)

## Thermo Scientific 96-well UV Plates



UV-transparent 96-well microplates are ideal for DNA and protein quantitation in the 260 nm and 280 nm range.

The 96-well format allows a higher throughput of sample screening compared to cuvettes.

### details

- Certified RNase and DNase free; non-pyrogenic
- Low background absorbance
- Measure protein concentrations at 280 nm
- Temperature range: -80°C to +40°C
- Working volume: 25 to 340 µL/well

**Compliance:** This Thermo Scientific microplate meets the recommendation of American National Standards Institute (ANSI).

### 96-Well UV Plates

Cat. No.	Surface	Well Design	Color	Total Vol., µL	Sterile	Lid	No. per Pack	No. per Case
8404	UV	96 F	Clear	392	No	No	10	40

## Thermo Scientific Nunc C96-Well Clear Polystyrene Microplates

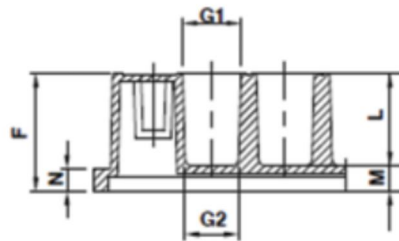

Nunc C96-well Polystyrene Plates offer the advantage of a flat-bottom well with the optimal washing of a U bottom plate.

The 96-well format allows a higher throughput of sample screening compared to cuvettes.

### details

- Clear polystyrene has excellent optical properties making it ideal for optical measurements
- Plates are optimized for robotics, plate readers and liquid handlers
- Customized bar coding is available
- Working volume range: 50 to 250 µL/well

**Compliance:** All Nunc microplates meet the recommendation of American National Standards (ANSI).

	mm
<b>Total height of plate</b>	<b>14.4 ± 0.1</b>
M Bottom of Well Distance	3.4
L Depth of Well	11
G1 Well diameter, top	06.6
G2 Well diameter, bottom	06.1
N Flange Short side	2.7

### Nunc C96-Well Clear/White Polystyrene Microplates

Cat. No.	Surface	Well Design	Color	Total Vol., µL	Sterile	Lid	No. per Pack	No. per Case
236001	Passively Coated Streptavidin	96 C	Clear	350	No	No	1	15
430341	MaxiSorp	96 C	Clear	350	No	No	5	60
437796**	MaxiSorp	96 C	White	350	No	No	5	60
446140	PolySorp	96 C	Clear	350	No	No	5	60
446612**	MaxiSorp	96 C	Clear	350	No	No	5	60

\*\*Certified

## Thermo Scientific Nunc MicroWell 96-well Optical-Bottom Plates with Polymer Base



Thermo Scientific™ Nunc™ MicroWell™ 96-well Optical-Bottom Plates have an opaque polystyrene black or white upper structure with a polystyrene film on the bottom of the plate.

The plates are optimized for fluorescence and luminescence in cell culture and microscopic applications.

White or black polystyrene upper structure with polymer bottom plates combine the optical clarity of virgin crystalline polystyrene with optimal surface for a wide range of HTS applications.

### details

- Black microplates are recommended for fluorescence measurements with minimum crosstalk and background fluorescence
- White microplates are recommended for luminescence measurements with maximum reflection and minimal autoluminescence
- Polymer base plate
- Working range, 50-200  $\mu\text{L}$ /well
- Customized bar coding is available

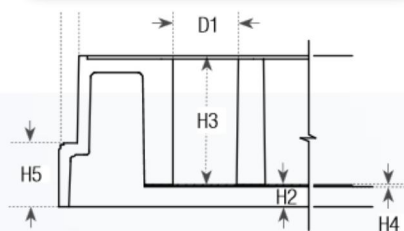

	mm
<b>Total height of plate</b>	<b>14.9</b>
H2 Vertical distance from inside well bottom to resting plane	2.2
H3 Inside depth of well	12.1
H4 Polystyrene film	0.25
H5 Height of flange	6.2
D1 Well diameter	6.5

**Compliance:** All Nunc microplates meet the recommendation of American National Standards Institute (ANSI).

### Nunc MicroWell 96-Well Optical-Bottom Plates with Polymer Base

Cat. No.	Surface	Well Design	Color	Bottom Plate	Total Vol., $\mu\text{L}$	Sterile	Lid	No. per Pack	No. per Case
152028*	Poly-D-Lysine	96 F	White	Polymer	400	--*	Yes	5	20
152036*	Collagen I	96 F	Black	Polymer	400	--*	Yes	5	20
152037*	Poly-D-Lysine	96 F	Black	Polymer	400	--*	Yes	5	20
152040*	Collagen I	96 F	White	Polymer	400	--*	Yes	5	20
165305**	Cell Culture	96 F	Black	Polymer	400	Yes	Yes	10	30
165306**	Cell Culture	96 F	White	Polymer	400	Yes	Yes	10	30
265301	Non-treated	96 F	Black	Polymer	400	No	No	10	30
265302	Non-treated	96 F	White	Polymer	400	No	No	10	30

\* Produced in a clean environment \*\* Certified

## Thermo Scientific Nunc MicroWell 96-well Optical-Bottom Plates with Coverglass Base



Nunc Optical Bottom Plates have an opaque polystyrene black or white upper structure with a coverglass plate bottom.

The plates are optimized for fluorescence and luminescence in cell culture and microscopic applications. The coverglass bottom has minimum light scatter and low autofluorescence, ensuring accurate results due to higher signal-to-noise ratio.

### details

- Black microplates are recommended for fluorescence measurements; with minimum crosstalk and background fluorescence
- White microplates are recommended for luminescence measurements; with maximum reflection and minimal autoluminescence
- Culture area, 0.32 cm<sup>2</sup>
- Cell culture surface is ideal for cell-based assays
- CC<sup>2</sup> surface modification closely mimics Poly-D-Lysine and is superior for attachment and growth of fastidious cells

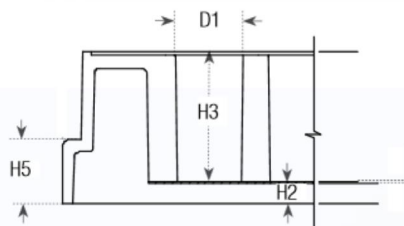

	mm
<b>Total height of plate</b>	<b>14.9</b>
H2 Vertical distance from inside well bottom to resting plane	2.2
H3 Inside depth of well	12.1
H5 Height of flange	6.2
D1 Well diameter	6.5

**Compliance:** All Nunc microplates meet the recommendation of American National Standards Institute (ANSI).

### Nunc MicroWell 96-Well Optical-Bottom Plates with Coverglass Base

Cat. No.	Surface	Well Design	Color	Bottom Plate	Sterile	Lid	No. per Pack	No. Per Case
160376	CC <sup>2</sup>	96 F	Black	No. 1.5 Coverglass	Yes	Yes	6	30
164588	Cell Culture	96 F	Black	No. 1.5 Coverglass	Yes	Yes	6	30
164590	Cell Culture	96 F	White	No. 1.5 Coverglass	Yes	Yes	6	30
265300	Non-treated	96 F	Black	No. 1.5 Coverglass	No	No	5	30

## Thermo Scientific 96-well Polypropylene Plates



**96-well Polypropylene Plates are the ideal storage plate. Polypropylene has low binding characteristics, allowing complete sample recovery.**

Withstands temperatures from  $-80^{\circ}\text{C}$  to  $+121^{\circ}\text{C}$ ; available in a variety of colors for quick identification of your storage plates.

Nunc microplates have shared-wall technology, which increases well volume and widens cells to improve mixing.

### details

- Wider wells and rounded bottom improve mixing
- Conical bottom wells for optimal sample recovery
- Excellent chemical resistance
- Black and white plates are available for fluorescent- and luminescent-based applications
- Low-binding for homogeneous assays and storage
- Ideal collection plate for Nunc Filter Plates
- U96-well plates – working volume range: 20 to 450  $\mu\text{L}$ /well
- V96-well plates – working volume range: 10 to 400  $\mu\text{L}$ /well
- Certified RNase/DNase-free

**Compliance:** All Thermo Scientific microplates meet the recommendation of the American National Standards Institute (ANSI).

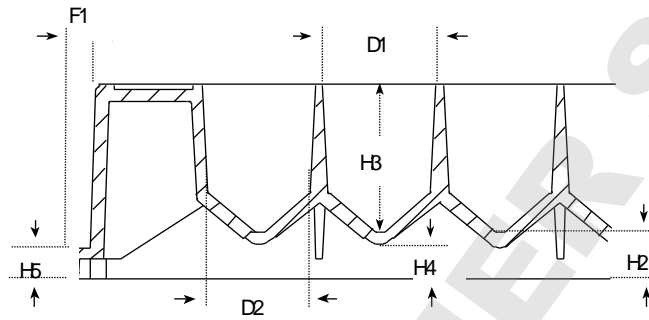

	mm
Total height of plate	14.5 ± 0.3
H2 Vertical distance from inside well bottom to resting plane	3.1
HB Inside depth of well	11.2
H4 Vertical distance from external well bottom to resting plane	2.0
H5 Height of flange on the short side	2.4
D1 Well diameter, top	8.5
F1 Depth of flange	1.7

	mm
Total height of plate	14.4 ± 0.1
H2 Vertical distance from inside well bottom to resting plane	3.4
HB Inside depth of well	11.0
H4 Vertical distance from external well bottom to resting plane	2.5
H5 Height of flange on the short side	2.3
H6 Height of flange on the long side	7.5
D1 Well diameter, top	8.5
D2 Well diameter, bottom	V-bottom
F1 Depth of flange	1.7

## 96-Well Polypropylene MicroWell Plates

Cat. No.	Surface	Well Design	Color	Total Vol., $\mu\text{L}$	Sterile	Lid	No. per Pack	No. per Case
249943	Non-Treated	96 V	Red	450	Nb	Nb	20	120
249944	Non-Treated	96 V	Natural	450	Nb	Nb	20	120
249945	Non-Treated	96 V	Black	450	Nb	Nb	20	120
249946	Non-Treated	96 V	Natural	450	Yes	Nb	20	120
249947	Non-Treated	96 V	Yellow	450	Nb	Nb	20	120
249949	Non-Treated	96 V	White	450	Nb	Nb	20	120
249950	Non-Treated	96 V	Blue	450	Nb	Nb	20	120
442587*	Non-Treated	96 V	Natural	300	Nb	Nb	5	60
267245	Non-Treated	96 U	Natural	500	Nb	Nb	10	120
267334	Non-Treated	96 U	Natural	500	Yes	Nb	10	120
267342	Non-Treated	96 U	Black	500	Nb	Nb	10	120
267350	Non-Treated	96 U	White	500	Nb	Nb	10	120
267369	Non-Treated	96 U	Red	500	Nb	Nb	10	120
267385	Non-Treated	96 U	Blue	500	Nb	Nb	10	120
267407	Non-Treated	96 U	Yellow	500	Nb	Nb	10	120
95040410	Non-Treated	96 Square	Natural	500	Nb	Nb	5	50

\* Finch bar design; does not meet ANSI standard.

## Thermo Scientific 96-DeepWell Polypropylene Plates



Nunc round-well plates



Square-well plates

DeepWell plates with shared-wall technology are ideal for sample collection, storage, combinatorial chemistry and library applications, and are resistant to most chemicals used in combinatorial chemistry.

Nunc shared-wall technology provides increased well volume optimizing storage capacity and improved mixing.

### details

- Ideal as a collection plate for Nunc Filter Plates
- Storage plate for compounds, samples or biomolecules
- Optimized for bacterial and yeast growth
- Round-bottom wells reduce liquid retention
- Widely used for bacteria and yeast growth
- Resistant to most chemicals, solvents and alcohols used in combinatorial chemistry
- Certified RNase-free

### Working volumes

- 1.0 mL polypropylene plates: 50-1000  $\mu\text{L}$ /well
- 2.0 mL polypropylene plates: 50-2000  $\mu\text{L}$ /well

**Recommended for:** Sample collection; storage; combinatorial chemistry; library applications; bacterial and yeast growth; collection plates for Nunc Filter Plates.

**Compliance:** All Thermo Scientific microplates meet the recommendation of American National Standards Institute (ANSI).



	mm		mm
<b>Total height of plate</b>	<b>31.6</b>	<b>Total height of plate</b>	<b>44.0</b>
H2 Vertical distance from inside well bottom to resting plane	2.5	H2 Vertical distance from inside well bottom to resting plane	2.5
H3 Inside depth of well	29.1	H3 Inside depth of well	41.5
H4 Vertical distance from external well bottom to resting plane	1.4	H4 Vertical distance from external well bottom to resting plane	1.5
D1 Well diameter, top	8.5	H5 Height of flange	2.5
D2 Well diameter, bottom	8.4	D1 Well diameter, top	8.5
F1 Depth of flange	2.5	D2 Well diameter, bottom	6.0
		F1 Depth of flange	1.5



## 1.3 and 2.0 mL DeepWell Plates

Cat. No.	Surface	Well Design	Color	Total Vol., mL	Sterile	Lid	Nb. per Pack	Nb. per Case
260251*	Non-treated	96 U	Natural	1.3	Yes	No	5	50
260252*	Non-treated	96 U	Natural	1.3	No	No	5	50
278743*	Non-treated	96 U	Natural	2.0	Yes	No	1	60
278752*	Non-treated	96 U	Natural	2.0	No	No	5	60
95040452	Non-treated	96 Square	Natural	2	No	No	5	50
95040462	Non-treated	96 Square	Natural	2	Yes	No	1	50

\* Shared Well Technology

## DeepWell Plates with Square Well Upper Structure

Cat. No.	Surface	Well Design	Color	Total Vol., mL	Sterile	Lid	Nb. per Pack	Nb. per Case
4211-11	Non-treated	96 U	Natural	1.0	No	No	40	40
4212-11	Non-treated	96 U	Natural	1.0	Yes	No	1	40
4221	Non-treated	96 U	Natural	2.0	No	No	40	40
4222	Non-treated	96 U	Natural	2.0	Yes	No	1	40

u Please see page 54 for Cap Mats



## Thermo Scientific Nunc 96-DeepWell Polystyrene Plates



The untreated surface of Nunc 96-DeepWell Polystyrene Plates provides uniform surface properties, making them ideal for cloning and replication assays.

The round bottom is ideal for agglutination assays and sample collection.

### details

- Optimized for robotics and liquid handling systems
- Round-bottom wells for optimal sample recovery
- Sealable with well caps and sealing tape
- Working range: 50 to 900  $\mu\text{L}$ /well

**Compliance:** All Nunc microplates meet the recommendation of American National Standards Institute (ANSI).

### Nunc 96-DeepWell Polystyrene Plates

Cat. No.	Surface	Well Design	Color	Total Vol., $\mu\text{L}$	Sterile	No. per Pack	No. Per Case
278605	Non-Treated	96 U	Clear	1.0	No	4	32
278606	Non-Treated	96 U	Clear	1.0	Yes	4	32

## Thermo Scientific Nunc 96-well Filter Plates



Nunc Filter Plates are optimized for efficient purification of high-quality plasmid DNA or PCR products.

Designed specifically for high-throughput sample processing, these 96-well filter plates are made of polypropylene, offering chemical resistance and mechanical strength. They are ideal for DNA plasmid preparations and PCR cleanups.

### details

- Designed specifically for high-throughput sample processing
- Suitable for vacuum, filtration, centrifugation or positive pressure techniques
- Polyethylene terephthalate (PET) frit in fritted plate has 20  $\mu\text{m}$  pore size
- Shared wall configuration gives reduced plate height, wider wells for faster processing, higher yields and less clogging
- Purified DNA is suitable for downstream applications such as sequencing and restriction digestion
- Glass Fiber plate has PET frit and two layers of glass fiber membrane for binding DNA

**Recommended for:** Protein purification, lysate clarification, general filtration.

**Compliance:** All Nunc microplates meet the recommendation of American National Standards Institute (ANSI).

### Flow diagram for plasmid DNA purification

#### Procedure:

Figure 1.  
Procedure on  
how to use  
Nunc Filter  
Plates for cost  
effective DNA  
purification.



Grow E. Coli cells in a sterile 2 mL DeepWell Plate (Cat. No. 278743). (overnight)  
Lyse bacteria and neutralize lysate. (15 min.) ↓

Clarify plasmid DNA with Fritted Filter Plate (Cat. No. 278011). (1 min.) ↓

Bind plasmid DNA to Glass Fiber Filter Plate (Cat. No. 278010). (3 min.)  
Wash and dry membrane. (8 min.) ↓

Elute pure plasmid DNA with TE into 1 mL reception DeepWell Plate (Cat. No. 260252). (12 min.) ↓

### Nunc 96-well Filter Plates

Cat. No.	Surface	Well Design	Color	Total Vol., $\mu\text{L}$	Working Vol., $\mu\text{L}$	Frit Size, $\mu\text{m}$	Sterile	No. per Pack	No. Per Case
278010	Non-Treated	96-well Glass Fiber Filter (Binding) Plate	Natural	1.3	1.0	20*	No	5	50
278011	Non-Treated	96-Fritted Well Deep Well Plate	Natural	1.3	1.0	20	No	5	50
278012	Non-Treated	96-Unfritted well Deep Well Plate	Natural	1.3	1.0		No	5	50

\* Features two layers of glass fiber membrane on top of PET frit

## Thermo Scientific 384-well Polystyrene Plates

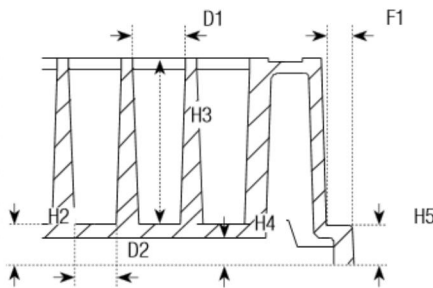

384-well Polystyrene Plates are optimized for robotics, plate readers and liquid handling systems. 384-well plates allow sample and reagent volume reduction, providing cost savings and allowing more samples to be screened.

Nunc 384-well Polystyrene Plates have rounded square-well geometry, eliminating wicking.

### details

- Clear polystyrene has excellent optical properties, making it ideal for optical measurements
- Untreated polystyrene is hydrophobic and is suited for the growth of suspension cultures that can proliferate and grow without attachment
- Untreated surfaces are ideal for adding coatings in your lab
- Cell Culture Treated: The Nunclon Delta cell culture treated surface is a hydrophilic surface that promotes cell attachment and growth
- Flexible working volumes: 10-100  $\mu\text{L}$

**Compliance:** Thermo Scientific microplates meet the recommendation of American National Standards Institute (ANSI).

	mm
<b>Total height of plate</b>	<b>14.4 <math>\pm</math> 0.25</b>
H2 Vertical distance from inside well bottom to resting plane	2.6
H3 Inside depth of well	11.7
H4 Vertical distance from external well bottom to resting plane	1.7
H5 Height of flange	2.7
D1 Well diameter, top	3.7
D2 Well diameter, bottom	2.7
F1 Depth of flange	1.9



## 384-well Polystyrene Plates

Cat. No.	Surface	Well Design	Color	Total Vol., $\mu$ L	Sterile	Lid	No. per Pack	No. Per Case
164610	Cell culture	384 F	White	120	Yes	Yes	10	30
164564	Cell culture	384 F	Black	120	Yes	Yes	10	30
164555	Cell culture	384 F	Clear	120	Yes	No	25	100
164688	Cell culture	384 F	Clear	120	Yes	Yes	10	30
242757	Non-treated	384 F	Clear	120	Yes	Yes	10	30
242765	Non-treated	384 F	Clear	120	Yes	Yes	1	30
262160	Non-treated	384 F	Clear	120	No	No	25	100
262260	Non-treated	384 F	Black	120	No	No	25	100
262360	Non-treated	384 F	White	120	No	No	25	100
265202	Non-treated	384 F	Clear	120	Yes	Yes	25	100
265203	Non-treated	384 F	Clear	120	Yes	No	25	100
165195	Cell culture	384 F	White	120	Yes	No	25	100
95040000	Non-Treated	384 C-Square	Clear	70	No	No	1	50
95040330	Non-Treated	384 C-Square	Black	70	Yes	Yes	1	40
460372	Maxisorp	384 F	White	120	No	No	10	30
460518	Maxisorp	384 F	Black	120	No	No	10	30
464718	Maxisorp	384 F	Clear	120	No	No	10	30
8755	Immulon 4HBX	384 F	Clear	120	No	No	1	50
436009	Amino	384 F	Clear	120	No	No	5	30
436012	Amino	384 F	Black	120	No	No	5	30
436018	Streptaidin	384 F	White	120	No	No	1	15

† Not Available in the Americas

## Thermo Scientific Nunc 384 Shallow Well Standard Height Plates



Nunc 384-well shallow well standard height clear plates

Nunc 384-well Shallow Well Standard Height Plates provide cost savings in samples and reagents by reducing the total well volume to 25  $\mu\text{L}$ .

The standard height of the plate allows the use of automation without making adjustments to robotics, plate readers or liquid handlers.

### details

- Untreated polystyrene is hydrophobic and suited for growth of suspension cultures that can proliferate and grow without attachment
- Untreated surfaces are ideal for adding coatings in your lab
- Working volume: 2–20  $\mu\text{L}/\text{well}$
- 25  $\mu\text{L}$  total volume saves reagents
- Clear polystyrene has excellent optical properties making it ideal for optical measurements
- Black microplates are recommended for fluorescence measurements with minimum crosstalk and background fluorescence
- White microplates are recommended for luminescence measurements with maximum reflection and minimal autoluminescence

**Compliance:** Nunc plates meet the recommendation of American National Standards Institute (ANSI).



	mm
<b>Total height of plate:</b>	<b>14.35</b>
H2 vertical distance from stacking rim to resting plane	1.14
H3 Inside depth of well	5.21
H4 Vertical distance from external well bottom to resting plane	8.4
5 Height of flange	2.16
D1 Well diameter, top	0.3

### Nunc 384-Well ShallowWell Standard Height Plates; Round Upper Structure, Flat bottom.

Cat. No.	Surface	Well Design	Color	Total Vol., $\mu\text{L}$	Sterile	Lid	No. per Pack	No. Per Case
264704	Non-treated	384 F	Clear	25	No	No	25	100
264705	Non-treated	384 F	Black	25	No	No	25	100
264706	Non-treated	384 F	White	25	No	No	25	100

## Thermo Scientific Nunc 384-well Optical Bottom Plates



Nunc 384-well Optical Bottom Plates are ideal for microscopic applications.

The black microplates are recommended for fluorescence measurements with minimum crosstalk and background fluorescence. White microplates are recommended for luminescence measurements, offering maximum reflection and minimal autoluminescence.

Rounded-square wells provide maximum access for dispensers and readers.

### details

- Poly-D-Lysine and Collagen coatings are ideal for cells with low adherence or growth; the uniform coating creates a positive charge on the surface that ensures cell attachment, growth and differentiation
- Cell Culture Treated: The Nunclon Delta cell culture treated surface is a hydrophilic surface that promotes cell attachment and growth
- Untreated polystyrene is hydrophobic and is suited for the growth of suspension cultures that can proliferate and grow without attachment and are ideal for adding coating in your own lab
- Polystyrene upper structure (available in black or white) with either a #1.5 cover glass or polystyrene base
- Working volume: 10 to 120  $\mu\text{L}$ /well

**Compliance:** All Nunc microplates meet the recommendation of American National Standards Institute (ANSI).



	mm
<b>Total height of plate</b>	<b>14.4 ± 0.25</b>
H2 Vertical distance from inside well bottom to resting plane	2.7
H3 Inside depth of well	11.6
H4 Vertical distance from external well bottom to resting plane	2.5
H5 Height of flange	2.7
H7 Bottom thickness	0.3
D1 Well diameter, top	3.7 x 3.7
D2 Well diameter, bottom	2.9 x 2.9
F1 Depth of flange	1.8

### Nunc 384-Well Optical Bottom Plates

Cat. No.	Surface	Well Design	Color	Total Vol., $\mu\text{L}$	Sterile	Lid	No. per Pack	No. Per Case
142761**	Cell Culture	384 F	Black	120	Yes	Yes	10	30
142762**	Cell Culture	384 F	White	120	Yes	Yes	10	30
152029	Poly-D-Lysine	384 F	Black	120	No	Yes	10	30
152041	Collagen I	384 F	Black	120	No	Yes	10	30
164586*	Cell Culture-Coverglass bottom	384 F	Black	120	Yes	No	6	30
164730**	Cell Culture	384 F	Black	120	Yes	No	10	30
240074*	Non-Treated Coverglass	384 F	Black	120	No	No	5	30
242763	Non-Treated	384 F	White	120	No	No	10	30
242764	Non-Treated	384 F	Black	120	No	No	10	30

\* 1.5 Coverglass \*\* Certified

## Thermo Scientific 384-well Polypropylene Plates



Nunc 384-well Polypropylene Plates provide cost savings when storing compounds for small volume applications.

Polypropylene is the ideal storage plate because it has a lower binding capacity so proteins or DNA will not bind, allowing complete sample recovery. Withstands temperatures from -80°C to +121°C. Offered in a variety of colors for quick identification of your storage plates.

### details

- Conical wells offer optimal sample recovery
- Rounded square wells minimize wicking (capillary action)
- The variety of colors is for quick identification of storage plates
- Chemically resistant to DMSO
- Round bottom improves mixing
- U384-well plates working volume range: 10-100 µL/well
- V384-well plates working volume range: 4-120 µL/well
- Certified RNase-free

Compliance: All Thermo Scientific microplates meet the recommendation of American National Standards Institute (ANSI).



### 384-Well Conical Bottom Polypropylene Plates

Cat. No	Well Design	Color	Total Vol., µL	Sterile	Lid	No. per Pack	No. Per Case
264573	384 U	Natural	120	No	No	20	120
264574	384 U	Natural	120	Yes	No	20	120
264575	384 U	White	120	No	No	20	120
264576	384 U	Black	120	No	No	20	120
264579	384 U	Blue	120	No	No	20	120
264675*	384 U	White	120	No	No	20	120
4305	384 V	White	145	Yes	No	10	80
4306	384 V	Black	145	Yes	No	10	80
4307	384 V	White	145	No	No	10	80
4308	384 V	Black	145	Yes	No	10	80
4309	384 V	Natural	145	Yes	No	10	80
4312	384 V	Natural	145	No	No	10	80

\* Low cross-talk



## Thermo Scientific Nunc 384-well ShallowWell Standard Height Polypropylene Plates



Nunc 384-well ShallowWell Standard Height Polypropylene Plates provide cost savings when storing compounds for small volume applications.

Polypropylene is ideal for storage plates because of its lower binding capacity so proteins or DNA will not bind and allows complete sample recovery. It withstands temperatures from -80°C to +121°C and is offered in a variety of colors to allow quick identification of your storage plates.

Polypropylene is a low-binding and chemically resistant surface making this plate ideal for storage.

### details

- Rounded well bottoms are optimized for mixing and sample recovery
- Chemical resistant to DMSO
- Rounded Square wells minimize wicking (capillary action)
- Natural plates for storage or colorimetric assays
- White plates for storage identification of luminescent assays
- Black plates for storage or fluorescent assays
- Working volume range: 2-35 µ/well
- Certified RNase-free

Compliance: All Nunc microplates meet the recommendation of American National Standards Institute (ANSI).

### Nunc 384-ShallowWell Standard Height Polypropylene Plates

Cat. No.	Surface	Well Design	Color	Total Vol., µL	Sterile	Lid	No. per Pack	No. Per Case
267459	Non-Treated	384 U	Natural	58	No	No	25	100
267460	Non-Treated	384 U	Natural	58	Yes	No	25	100
267461	Non-Treated	384 U	Black	58	No	No	25	100
267462	Non-Treated	384 U	White	58	No	No	25	100

u For custom barcoded plates, visit [www.thermoscientific.com/barcodeconfigurator](http://www.thermoscientific.com/barcodeconfigurator)

## Thermo Scientific Nunc DeepWell Plates:

# Delivering the low-bind performance of specialty microplates at lower cost

Microplates offer a convenient solution for manipulating and storing large numbers of samples. To prevent sample loss caused by the non-specific binding of biomolecules, polypropylene plates with low-binding characteristics are essential.

Expensive specialty storage plates offer a solution. But testing\* has shown that Thermo Scientific™ Nunc™ DeepWell plates offer the same level of high performance more economically, including low binding and a high centrifugation RCF rating.

\*Tested for centrifugation applications in a Thermo Scientific™ Lynx™ 6000 centrifuge, using the BioFlex HC rotor and microplate adapter. All plates reached the RCF of 7,068 xg at the maximum speed of the rotor.

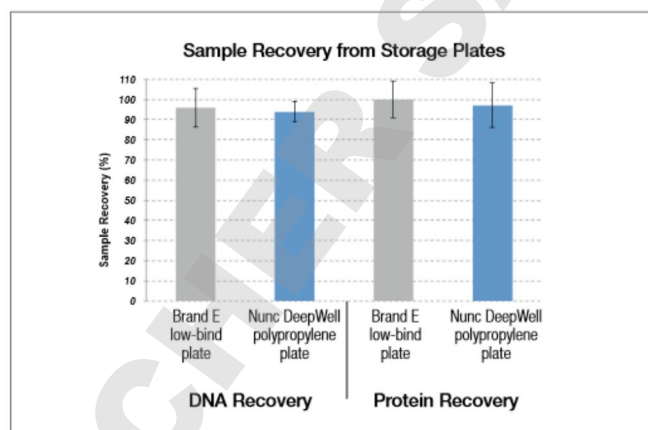

Percent recovery of DNA and protein samples stored in polypropylene deepwell microplates. Error bars represent one standard deviation.



For more information, visit [www.thermoscientific.com/plateguide](http://www.thermoscientific.com/plateguide)

## Thermo Scientific Nunc 384 DeepWell Polypropylene Plates



Nunc 384 DeepWell Plates are ideal for compound library storage. The deep well design accommodates larger working volumes, and the rounded square well minimizes wicking (capillary action).

Polypropylene is the ideal storage plate material, with a lower binding capacity so proteins or DNA will not bind. Allows complete sample recovery.

Polypropylene is a low-bind and chemically resistant surface, making this plate ideal for storage.

#### details

- Raised rims around each well are ideal for heat or adhesive sealing
- Rounded wells are optimized for mixing
- Compatible with robotics and automation
- Optimized for liquid handling systems
- Working volume range: 5-240  $\mu\text{L}$ /well
- Certified RNase-free

**Compliance:** All Nunc microplates meet the recommendation of American National Standards Institute (ANSI).

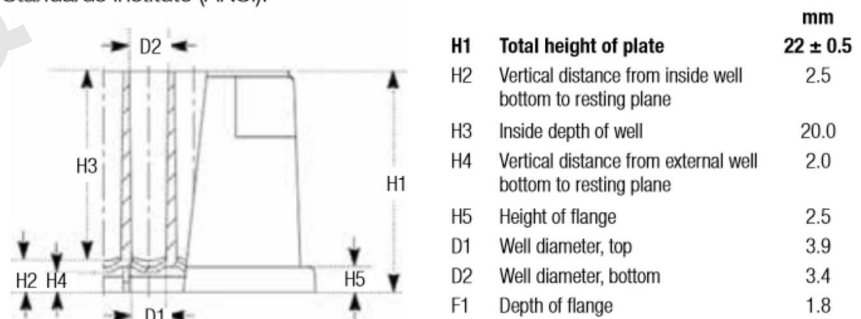

#### Nunc DeepWell 384-Well Plate

Cat. No.	Surface	Well Design	Color	Total Vol., $\mu\text{L}$	Sterile	Lid	No. per Pack	No. Per Case
269390	Non-Treated	384 U	Natural	252	No	No	5	60

## Thermo Scientific Nunc 1536-well Polystyrene High Base Microplates



Nunc 1536-well Polystyrene High Base Microplates are ideal for high-throughput screening. The skirted design around the base of the plate is optimal for robotic handling.

Work with small volumes and screen four times as many samples in one plate.

### details

- Black plates are recommended for fluorescence measurements with minimum crosstalk and background fluorescence
- White microplates are recommended for luminescence measurements with maximum reflection and minimal autoluminescence
- Cell Culture Treated: The Nunclon Delta cell culture treated surface is a hydrophilic surface that promotes cell attachment and growth.
- Working range: 2-10  $\mu\text{L}$ /well

Compliance: All Nunc microplates meet the recommendation of American National Standards Institute (ANSI).

### Nunc 1536-Well High Base Microplates

Cat. No.	Surface	Well Design	Color	Total Vol., $\mu\text{L}$	Sterile	Lid	Nb. per Pack	Nb. per Case
164707	Cell Culture	1536 F	Clear	13.4	Yes	Yes	25	100
164708	Cell Culture	1536 F	Black	13.4	Yes	Yes	25	100
164709	Cell Culture	1536 F	White	13.4	Yes	Yes	25	100
264710	Non-Treated	1536 F	Clear	13.4	Nb	Nb	25	100
264711	Non-Treated	1536 F	Black	13.4	Nb	Nb	25	100
264712	Non-Treated	1536 F	White	13.4	Nb	Nb	25	100

## Thermo Scientific Nunc 1536-well Polystyrene Microplates

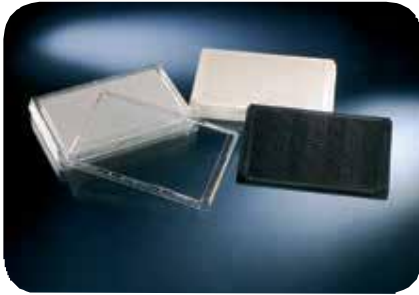

Nunc 1536-well Polystyrene Microplates are ideal for high-throughput screening.

Work with small volumes and screen four times as many samples in one plate.

### details

- Low plate height is optimized for stacking
- Black microplates are recommended for fluorescence measurements with minimum crosstalk and background fluorescence
- White microplates are recommended for luminescence measurements with maximum reflection and minimal autoluminescence
- Working well volume: 1-10  $\mu\text{L}$ /well

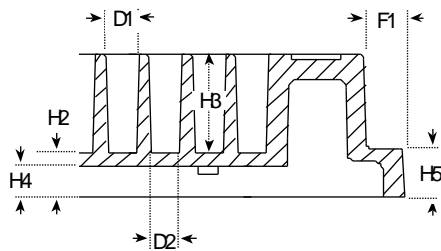

Compliance: All Nunc microplates meet the recommendation of American National Standards Institute (ANSI).

	mm
Total height of plate	7.4
H2 Vertical distance from inside well bottom to resting plane	2.4
H3 Inside depth of well	5.0
H4 Vertical distance from external well bottom to resting plane	1.5
H5 Height of flange	2.5
D1 Well diameter, top	1.7
D2 Well diameter, bottom	1.5
F1 Depth of flange	1.8

### Nunc 1536-Well Microplates Plates

Cat. No.	Surface	Well Design	Color	Total Vol., $\mu\text{L}$	Sterile	Lid	No. per Pack	No. Per Case
253601	Non-Treated	1536 F	Black	13.4	Nb	Nb	30	90
253607	Non-Treated	1536 F	White	13.4	Nb	Nb	30	90
253614	Non-Treated	1536 F	Clear	13.4	Nb	Nb	30	90

u For custom barcoded plates, visit [www.thermoscientific.com/barcodeconfigurator](http://www.thermoscientific.com/barcodeconfigurator)

## Thermo Scientific Microplate Lids



Microplate Lids protect samples from contamination and evaporation during assay processing, incubation or storage.

### details

- 96-well lids with individual condensation rings
- Lids have notches for quick orientation
- Universal lids can be used on any standard height plate on the market

### Nunc Microplate Lids

Cat. No.	Height, without stacking holders, mm	Cut-off Corners	Condensation Rings	Evaporation Barrier	Color	Sterile	No. per Pack	No. Per Case
<b>Standard Lids, for 96-MicroWell Plates</b>								
<b>With condensation rings and evaporation rim; Polystyrene; External dimensions 127 x 85 mm</b>								
263339	Standard, 7.9	Long Side	Yes	Yes	Clear	No	5	100
264122	Standard, 7.9	Long Side	Yes	Yes	Clear	Yes	1	50
264623	Standard, 7.9	Long Side	Yes	Yes	Clear	Yes	20	60
<b>Standard Lids for 384-well Plates</b>								
<b>With evaporation rim; Polystyrene; External dimensions 127 x 85 mm</b>								
264611	Standard, 7.9	Long side	No	Yes	Clear	Yes	1	60
264612	Standard, 7.9	Long side	No	Yes	Clear	No	20	180
264616	Standard, 7.9	Long side	No	Yes	Clear	Yes	20	180
<b>White Lid, for 384- and 1536-well Plates and OmniTrays</b>								
<b>Polystyrene; External dimensions 127 x 85 mm</b>								
448143	Standard, 7.9	Long side	No	No	White	No	20	120
<b>Universal Lid for 384- and 1536-well Plates</b>								
<b>With side cut-out and evaporation rim; Polystyrene; External dimensions 127 x 85 mm</b>								
250002	Standard, 8.34	No	No	No	Clear	Yes	20	60
250003	Standard, 8.34	No	No	No	Clear	No	20	60
250005	Standard, 8.34	No	No	No	Clear	No	20	180
<b>LowBot Lids, Universal Version for 384- and 1536-well Plates</b>								
<b>With condensation rings and evaporation rim; Polystyrene; External dimensions 127 x 85 mm</b>								
253623	Low profile, 4.6	No	No	Yes	Clear	No	25	100
253624	Low profile, 4.6	No	No	Yes	Clear	Yes	25	100
<b>Automation Friendly Lids; External dimensions 127 x 85 mm</b>								
4954	Automation Friendly, 8.9	No	No	Yes	Clear	Yes	10	80
4955	Automation Friendly, 8.9	No	No	Yes	Black	Yes	10	80

# barcode configurator



**Simplify sample tracking using Thermo Scientific™ Nunc™ Microplates with custom barcodes created by the Nunc Barcode Configurator.**

Barcodes provide a tool for managing large quantities of data and establishing historical identification of plate content at any point in an assay or method. Creating a customized barcode is fast and easy using our simple step-by-step interface. Bring the power of bar coding to your process:

- Choose from 5 code types to best meet your application needs
- Select your label location – apply to one or more plate sides
- No repeats – guaranteed!
- Human-readable option, including positions and highlight color
- Sequences archived for data management
- Print a sample barcode to ensure compatibility with your reader

To create your own custom barcodes, go to  
[www.thermoscientific.com/barcodeconfigurator](http://www.thermoscientific.com/barcodeconfigurator)

## Thermo Scientific Nunc Barcode Scanners



Nunc Barcode Scanners with “Plug and Play” functionality play a critical role in sample tracking.

The scanner can automatically switch to read codes: 128A, 128B, 128C, 39 and Interleave 2/5. Convenient and simple to use with a Microsoft® Excel® spreadsheet.

Durable, low cost, and easy to use – simply plug into a USB or keyboard port.

### details

- Scanners automatically switch between Code 128, Code 39, Interleave 2 of 5 and several other barcodes
- Must be in contact with the barcode to read

### Nunc Barcode Scanners

Cat. No.	For Use with
330040	Nunc Bar Code Scanner; designed to plug into any keyboard
330050	Nunc Bar Code Scanner; designed to plug into any USB port





## Thermo Scientific Nalgene Horizontal Storage Racks for Microplates



Thermo Scientific™ Nalgene™ Horizontal Storage Racks provide a secure, convenient storage system and allow transport of samples in standard and deepwell plates.

These racks are ideal for genome library storage, DNA and RNA libraries, and storage of compounds for high-throughput screening.

### details

- Horizontal design fits most refrigerators and freezers
- Retainer clip on each compartment holds plates securely in place
- Handles on tops and sides for easy transport
- Label holder for easy identification of rack contents

Nalgene Horizontal Storage Racks for Microplates

Cat. No.	Array	Capacity	Holds	L x W x H, cm (in.)	No. per Case
5039-0048	4 x 4	80 Low profile, 48 Standard, 16 Deep well	48 standard plates (16 deep well)	38.7 x 13.9 x 21.6 (15 x 5.5 x 8.5)	1
5039-0072	4 x 6	120 Low Profile, 72 standard, 24 Deep well	72 standard plates (24 deep well)	57.9 x 13.9 x 12.6 (23 x 5.5 x 8.5)	1

## Thermo Scientific Nunc Microplate Plastic Storage Racks



Nunc Plastic Storage Racks provide a secure, convenient storage system and allow transport of samples in standard and deepwell plates.

These racks are ideal for genome library storage, DNA and RNA libraries, and storage of compounds for high-throughput screening.

### details

- Horizontal design fits chest, upright freezers and incubator
- Retainer clip holds plates securely in place
- Handles on top and side for easy transport
- Locking bar keeps plates secure
- Handle allows convenient transport
- Freezer compatible down to -80°C
- Not for use in liquid/vapor nitrogen

Nunc Microplate Plastic Storage Racks

Cat. No.	Type	Style	L x W x H, cm (in.)	Shelf Height, cm (in.)	Color
344260	Standard Height	10 Tall	23 x 10 x 14 (9.05 x 3.94 x 5.5)	2 (3/4)	Green
344280	Standard Height	10 Tall x 5 Wide	25 x 51 x 14 (9.88 x 20.13 x 5.5)	2 (3/4)	Green
344380	DeepWell	5 Tall x 15 Wide	25 x 51 x 14 (9.88 x 20.13 x 5.5)	5 (2)	Green

## Thermo Scientific Nunc Vertical Microplate Storage Racks



Nunc Vertical Microplate Storage Racks provide a secure, convenient storage system and allow transport of samples in standard and deepwell plates.

These racks ideal for genome library storage, DNA and RNA libraries, and storage of compounds for high-throughput screening.

### details

- Adjustable shelves to fit any plate
- Vertical design optimizes room in chest and upright freezers
- Retainer clip holds plates securely in place
- Handles on tops for easy transport
- Alignment rod on the front side secures plates and allows barcode reading
- Aluminum
- Autoclavable

### Accommodates:

- 18 Low Profile Microplates
- 10 Standard Height Microplates
- (6) 1 mL Deep Well Plates
- (5) 2 mL Deep Well Plates

Nunc Vertical Microplate Storage Racks

Cat. No.	Color	Material	L x W cm (in.)	No. per Case
367002	Natural	Aluminum	13.5 x 9.5 (5.31 x 3.74)	1

## Thermo Scientific Nunc-Immuno Washers



Nunc-Immuno Washers allow flexible washing procedures and are ideal for low-throughput labs that do not have microplate washers.

The Nunc Immuno Washer is available in 8- and 12-channel versions to fit all 96-well plates.

Adjustable to all well shapes. No electrical connections required.

#### details

- Uniform and efficient washing
- Simple and easy to use
- Can be autoclaved for sterilization
- Design eliminates overfilling and cross-contamination
- Autoclavable at 121°C (250°F) for sterilization of immuno washer

**Ordering Information:** Dimensions: 10.25 L x 4.5W x 3.75 in. D (26 x 11.5 x 9.5 cm).

**Includes:** Two thumbscrews and one ruler for required adjustments for washing alternative well types; rack for secure storage support; spare parts kit for routine maintenance and cleaning wire. Spare parts kit includes five different O-rings and one spring.

#### Nunc-Immuno Washers

Cat. No.	Description	Includes
470174	8-Channel Washer	Spare parts kit, ruler and rack
470175	12-Channel Washer	Spare parts kit, ruler and rack

## Thermo Scientific Nunc Replication System



Nunc Replication Systems are designed for the replication of DNA libraries and are ideal for transferring small volumes from plate to plate.

These replication systems work with Nunc 96- and 384-well microplates.

Ideal for transferring small volumes of inoculum from plate to plate or membrane.

### details

- Pins transfer 1.0  $\mu\text{L}$  of liquid or 0.1  $\mu\text{L}$  to solid supports
- Pins are flame-proof stainless steel for sterilization
- MicroWell copier alignment device simplifies conversion of 96-MicroWell plates to 384-well format
- Flame-proof stainless steel pins on 96- and 384-Pin Replicator
- For use with 96- and 384-well Plate and OmniTray

### Nunc Replication System

Cat. No.	Description	Fits	L x W x H, mm	Material	Volume, $\mu\text{L}$
250393	Replicator	384-wells	121.6 x 83.3 x 135.4	Anodized aluminum with stainless steel pins	1 $\pm$ 0.1
250520	Replicator	96-wells	121.6 x 83.3 x 135.4	Anodized aluminum with stainless steel pins	1 $\pm$ 0.1

## Thermo Scientific Nalgene Disposable Polypropylene Robotic Reservoirs



Nalgene Disposable Polypropylene Robotic Reservoirs with a standard microplate format and 300 mL volume offer greater walk-away time and assay efficiency.

The convoluted design minimizes dead volume and has baffles to reduce splashing. The flat bottom version is designed to meet a variety of assay needs in both manual and automated environments.

### details

- Convoluted bottom design is most effective with a 96-well format
- Flat Bottom design can be used with single, 6-, 12-, 96-, 384- and 1536-well formats
- Polypropylene construction withstands robotic liquid handling, making it easier to run automated assays and increasing walk-away time
- Compatible with most robotic arms, plate stackers (hotels), plate cranes and platform configurations
- Reservoir volume is 300 mL (345 mL brim capacity), with molded-in graduations every 100 mL
- Nestable, for easy automated stacking and handling

**Dimensions:** 3.4 L × 5 W × 1.75 in. H (86 × 128 × 43 mm)

**Compliance:** Meets the recommendation of American National Standards Institute (ANSI).

### Nalgene Disposable Polypropylene Robotic Reservoirs

Cat. No.	Bottom Shape	Total Vol., $\mu$ L	Sterile	No. per Pack	No. Per Case
1200-1300	Flat	300	No	4	40
1200-1301	Flat	300	Sterile	4	40
1200-2300	Convoluted	300	Sterile	4	40
1200-2301	Convoluted	300	No	4	40

## Thermo Scientific Nunc 96-well Cap Mats



Nunc 96-well Cap Mats for polypropylene plates will protect well contents during short-term or long-term storage of chemicals or compounds.

### details

- Chemically resistant and pierceable; withstand low temperature to  $-80^{\circ}\text{C}$
- Pre-slit silicone well caps permit a pipette tip or probe to enter the well without damage to the cap
- The variety of colors for quick identification of storage plates
- Silicone caps with pre-slit are solvent resistant; should not be subjected to 100% DMSO

**Notes:** Capmats fit both 96-well Polypropylene DeepWell and Standard Height Shared Wall Plates. Cat. No. 276011 preslit silicone caps can be pierced repeatedly. Do not use pre-slit silicone with 100% DMSO.

### Nunc 96-Well Cap Mats

Cat. No.	Well	Under Well Shape	Pierceable	Slit	Color	Sterile	No. per Pack	No. Per Case
276000**	96	Round	Pierceable*	Not preslit	Natural	Yes	1	50
276002**	96	Round	Pierceable*	Not preslit	Natural	No	5	50
276003**	96	Round	Pierceable*	Not preslit	Yellow	No	5	50
276004**	96	Round	Pierceable*	Not preslit	Red	No	5	50
276005**	96	Round	Pierceable*	Not preslit	Blue	No	5	50
276011**	96	Round	Pierceable*	Preslit can be pierced repeatedly.	Natural	No	10	50
4410	96	Round	No	Not preslit	Natural	No	100	100
4411-11	96	Round	No	Not preslit	Natural	No	10	10
4412-11	96	Round	No	Not preslit	Natural	Yes	10	10
4413-11	96	Round	No	Not preslit	Natural	No	240	240
4414-11	96	Round	No	Not preslit	Natural	Yes	240	240
4415	96	Round	No	Not preslit	Natural	No	240	240
4416	96	Round	No	Not preslit	Natural	Yes	240	240
4420	96	Square	No	Not preslit	Natural	No	100	100
4421	96	Square	No	Not preslit	Natural	No	10	10
4422	96	Square	No	Not preslit	Natural	Yes	10	10
4430-11	96	Round	No	Not preslit	Natural	No	100	100
4431-11	96	Round	No	Not preslit	Natural	No	10	10
4432-11	96	Round	No	Not preslit	Natural	Yes	10	10
9503230	96	Square	Pierceable*	Not preslit	Natural	No	5	50
9503233	96	Square	Pierceable*	Not preslit	Natural	Yes	1	25

\* Pierceable by hypodermic    \*\* For shared-wall plates    \* Not available in Americas    \* Only available in Americas

## Thermo Scientific Nunc Sealing Tapes



Nunc Sealing Tapes minimize evaporation and protect samples from contamination and spilling.

Adhesive seals are ideal for all assay applications.

### details

- Wide range of adhesive seals for every assay
- Adhesive seals effectively seal all microplate formats
- Pressure-sensitive adhesive is not tacky to touch, but forms a strong bond to the plate upon application of pressure
- Thin, lightweight tapes seal onto the plate with a convenient, handheld applicator (available separately, Cat. No. 250050)



Cat. No. 250050

### Nunc Sealing Tapes

Cat. No.	Material/Adhesive	Application	Color	Sterile	Pierceable	Certified RNase/DNase-free	Temperature Range	No. per Pack	No. Per Case
232698	Aluminum/Acrylate	PCR and storage in 96-well plates	Silver	No	Yes	Yes	-80° to +150°C	100	100
232699	Aluminum/Acrylate	PCR and storage in 384-well plates	Silver	No	Yes	Yes	-80° to +150°C	100	100
232701	Polyolefin/Acrylate	Low autofluorescence; DMSO compatible; microscopy	Clear	No	No	No	-70° to +100°C	100	100
232702	Polyolefin/Acrylate	PCR; fluorescence assays; microscopy	Clear	No	No	Yes	-70° to +100°C	100	100
235306	Polyethylene/Silicone	Repeated piercing; low autofluorescence	Clear	No	Yes	No	-40° to +90°C	100	100
235307	Polyolefin/Silicone	Q-PCR; microscopy, lowest fluorescence	Clear	No	No	No	-70° to +100°C	100	100
236269*	Polyester/Acrylate	Stiffer than polyolefin; general purpose	Clear	No	No	No	-20° to +100°C	200	800
236272	Polyester/Acrylate	Opaque; luminescence assay; bottom of plate	White	No	No	No	-40° to +80°C	50	50
236366	Polyester/Acrylic	Cell culture; sterile applications	Clear	Yes	No	No	-70° to +100°C	200	800
236370*	Polyester/Silicone	General purpose; sample protection	Clear	No	No	No	-70° to +100°C	100	100
236703	Vinyl/Acrylate	For plate top or bottom; photo-sensitive samples	Black	No	No	No	-40° to +80°C	50	50
236707	Polyester/Acrylic	Convenient roll dispenser; general purpose	Clear	No	No	Yes	-20° to +100°C	1000	1000
241205	Rayon/Acrylate	Breathable; cell culture	White	Yes	Yes	No	-20° to +80°C	20	50
249720	Rayon/Acrylate	Breathable	White	No	No	Yes	-20° to +80°C	50	50
276014	Aluminum/Silicone	General use, PCR, photo-sensitive samples	Silver	No	Yes	Yes	-80° to +120°C	100	100
250050		Hand held applicator promotes consistent seal	Gold		No	No		2	2

+ Only available in the Americas \* NOT available in the Americas

## Thermo Scientific SuperSealer



Ensure a proper seal on plates, blocks and storage tube racks with the Thermo Scientific™ SuperSealer™.

Choose individual sealing options such as Thermo Scientific™ Matrix™ SepraSeal™ mats for liquid handling and single tube accessibility – or seal entire plates and blocks for storage with Thermo Scientific Nunc CapMats. Effectively apply adhesive tape seals and ensure a tight seal with the included SuperSealer Adhesive Seal Mat.

### details

#### Sealing Simplicity

- Simplifies the sealing of plates, blocks and tube racks of virtually any height, with no adjustments needed, ensuring a secure and consistent seal
- Once the seal along with the plate, block or tube rack are placed into the drawer, simply close the door to initiate sealing

#### Sealing Flexibility

- Designed to work with Thermo Scientific Matrix SepraSeal mats, any CapMats or any pre-cut adhesive tape seal – you can be assured of getting a proper seal regardless of sealing option

**Includes:** Automatic cap, tape and SepraSeal mat applicator

**Warranty:** 1-Year, in-factory warranty on parts and labor

**Certifications:** CE Marked



Specifications	
Speed	10-15 seconds/plate, block or rack of tubes
Dimensions W x D x H	165 x 317.5 x 343 mm (6.5 x 12.5 x 13.5 in.)
Weight	13.5 kg (30 lbs.)
Power Supply	110-240V

*\*The SuperSealer is designed to only work with full racks of tubes*

### SuperSealer

Cat. No.	Description
4110-11	Thermo Scientific Super Sealer
4423	Mat for Adhesive Seal Application with Super Sealer



## Thermo Scientific ALPS 25 Manual Heat Sealer



The ALPS 25 Manual Heat Sealer is a simple-to-use, hand-operated sealer designed for low-throughput labs.

Heat sealing offers superior sample protection of storage and reaction plates in applications that include compound storage, sample archiving and PCR applications.

### details

#### Sealing Flexibility

- Compatible with virtually any height microplate or block, including PCR plates
- Choose from a wide range of heat seals for any application, including piercable, optically-clear and permanent

#### Safe, Compact Design

- Built-in thermostat controls trigger automatic system shutoff to prevent overheating of the ALPS 25 sealer
- Lightweight with small footprint for ease of placement and relocation

**Compatible Products:** The ALPS 25 sealer is part of a complete line of microplate heat sealing instruments. For enhanced ergonomics, and variable time and temperature settings, consider the semi-automated Thermo Scientific ALPS 50 V microplate heat sealer. For automated microplate sealing, see the Thermo Scientific ALPS 3000.

**Warranty:** 1-year, in-factory warranty on parts and labor.

**Certifications:** CE marked.

Unit includes Cat. No. AB-0563/1000.



Specifications	
Operating Temperature Range	10° to 35°C
Sealing Temperature Range	Ambient to 220°C
Operating Humidity Range	10 to 80%
Fuse	5A/110V/500W
Power Supply	5A (AB-0384/110); 3.15A (AB-0384/220)
Dimensions W x D x H	140 x 330 x 150 mm (5.5 x 13 x 5.9 in.)
Weight	3.4 kg (7.5 lbs.)

### ALPS 25 Manual Heat Sealer

Cat. No.	Description	No. per Case
AB-0384/110	ALPS 25 Manual Heat Sealer, 100 Volt	1
AB-0384/220	ALPS 25 Manual Heat Sealer, 220 Volt	1

### ALPS Heat Sealer Accessories

Cat. No.	Description	No. per Case
AB-0563/1000	96Well PCR Plate Carrier	1
AB-0592	Foil Stripper	1
AB-0724	384Well PCR Plate Carrier	1
AB-0827	Standard Microplate Carrier	1
AB-1118	96Well (V) Conical Bottom Storage Plate Carrier	1

## Thermo Scientific ALPS 50 V Microplate Heat Sealer



The semi-automated ALPS 50 V Microplate Heat Sealer is designed to provide sealing consistency in low- to medium-throughput labs.

Heat sealing offers superior sample protection of storage and reaction plates in applications that include compound storage, sample archiving and PCR.

With the semi-automated ALPS 50 V microplate heat sealer, secure tight seals around individual wells eliminate sample loss through evaporation and cross contamination between wells. Choose from a wide range of heat seals, including pierceable, optically-clear and permanent, for any application.

### details

#### Application Flexibility

- Simple on-board touch pad controls adjust sealing temperature and time for reproducible results
- Audible alarm indicates sealing completion

#### Ergonomic Design

- Compact footprint conserves bench space
- Counter lever handle design provides minimal strain when operating the instrument
- Lightweight, at only 7.2kg (15.9 lbs.) for easy relocation

**Warranty:** 1-year, in-factory warranty on parts and labor

**Certifications:** CE marked

Unit includes Cat. Nos. AB-0563/1000 and AB-0827.



Specifications	
Temperature Setpoint Range	125° to 200°C in 1°C increments
Time Set Point Range	1 to 9 seconds in 0.5 second increments
Operating Temperature Range	18° to 30°C
Humidity Control	20-80% noncondensing
Power Rating	100-130V – T3.15A (IEC 127) or 220-240V – T1.6A (IEC 127)
Power Supply	100-130 VAC, 50-60Hz or 220-240 VAC, 50-60Hz, 350W fuse
Fuse	350W
Mains Input Connector	IEC 320
Dimensions W x D x H	220 x 321x 425 mm (8.7 x 12.6 x 16.7 in.)
Weight	7.2 kg (15.9 lbs.)

### ALPS 50 V Microplate Heat Sealer

Cat. No.	Description	No. per Case
AB-1443A	ALPS 50 V Semi automated Microplate Heat Sealer	1

### ALPS Heat Sealer Accessories

Cat. No.	Description	No. per Case
AB-0563/1000	96Well PCR Plate Carrier	1
AB-0592	Foil Stripper	1
AB-0724	384-Well PCR Plate Carrier	1
AB-0827	Standard Microplate Carrier	1
AB-1118	96Well (V) Conical Bottom Storage Plate Carrier	1

## Thermo Scientific ALPS 3000 Automated Microplate Heat Sealer



ALPS 3000 Automated Microplate Heat Sealer is a fast, compact heat sealer created for optimal robotic integration in high-throughput labs, yet allows manual, benchtop control.

### details

- Compact footprint (165 x 405 mm) to conserve bench space
- Top-loaded seals are easily accessible

### Fast, Easy-to-use

- Light (11.8kg / 26 lbs.)
- Seals are top-loading and easily accessible
- Rapid plate sealing action (6 seconds/plate) in either high-throughput robotic applications or benchtop, hand-fed operations
- Available with a variety of available heat seals to meet any laboratory application, including PCR, colorimetric, fluorescence, long-term storage, low temperature storage, piercing and resealing
- On-board touch screen operation for benchtop use and RS232 port with included ASCII programming parameters for robotic integration

### Safe and Secure

- Sensors detect the presence of sealing tape and plate
- Air input allows automatic system shutoff to eliminate product waste, system hold-ups and potential injury

### Sealing Flexibility

- Compatible with virtually any height microplate or block, including PCR plates

**Warranty:** 1-Year, in-factory warranty on parts and labor

The ALPS 3000 comes with 3 adapters to support a variety of standard microplates with various height skirts (2, 2.5, and 3 mm) and the 96-well PCR plate adapter (Cat. No. AB-0563/1000).

**Certifications:** CE Marked

### ALPS 3000 Automated Microplate Heat Sealer

Specifications	
Dimensions W x D x H	414 x 185 x 350 mm (16.3 x 7.3 x 13.8 in.)
Weight	12 kg (26.5 lbs.)
Speed	6 to 12 seconds per plate
Power Supply	110-240 VAC, 50-60 Hz
Air Requirements	50 liters per minute
Air Input Pressure	5.5 bar (80psi) to 5.7 bar (87psi)
Sealing Temperature Range	Ambient to 200°C
Operating Temperature Range	15° to 40°C
Sealing Plate Height, mm	8 to 46

Cat. No.	Description	No. per Case
AB-3000	ALPS 3000 Automated Microplate Heat Sealer	1
AB-0592	Foil Stripper	1

### ALPS 3000 Automated Heat Sealer Accessories

Cat. No.	Description	No. per Case
AB-0563/1000	96-well PCR plate adapter	1

## Thermo Scientific Heat Seals



**Heat-sealed microplates are ideal for storage applications.**

Advantages over other plate sealing methods include time and cost savings and sealing integrity. When heat sealing, the sealing material is first placed in position over the plate, which must have a raised rim around each well. Heat is applied evenly for several seconds, resulting in binding of the sealing material to the raised rim to achieve a complete seal. Heat sealing offers the capability of retrieving samples and then re-sealing the plate.

### details

See table below for detailed description of each seal

#### Thermo Scientific Heat Seals are:

- Fast
- Safe for temperature-sensitive samples
- Designed for reliable performance with Thermo Scientific ALPS instruments, including the ALPS 3000, ALPS 25 and ALPS 50 V

For compatible heat sealers used with these products, see ALPS 25, ALPS 50 and ALPS 3000 Heat Sealers.

## Heat Seals, Single Sheets

Cat. No.	Plate Material Types	Description	Compatible with:	Dimensions, mm	Packaging
AB-0559	PP	Thermo Seal: Foil laminate; Very strong seal; Excellent chemical resistance; Recommended for use with DMSO The robust sealing option	ALPS 25 and 50V	85 x 135	100 sheets
AB-0685	PP	Clear Seal: Strong Clear polyester-polypropylene seal cannot be peeled or pierced; Optically transparent for sample inspection	ALPS 25 and 50V	85 x 135	100 sheets
AB-0745	PP, PE & CCC	Easy Peel: Foil laminate for long-term storage; good for low temperatures to -200°F	ALPS 25 and 50V	85 x 135	100 sheets
AB-0757	PP & PE	Easy Pierce: Easily pierced foil material for PP, PE and PCR; Accepts secondary foil application for re-sealing; Good chemical compatibility; Ideal for use with DMSO	ALPS 25 and 50V	85 x 135	100 sheets
AB-0812	PP, PS, PE & CCC	Diamond Seal: Clear polymer seal	ALPS 25 and 50V	85 x 135	100 sheets
AB-1720	PP & PE	Easy Pierce: 20 µm Thin foil for excellent pierceability, including multiple seals for repeated sealing; 85 X 135 mm sheets; For use with the ALPS 25 and ALPS 50V	ALPS 25 and 50V	85 x 135	100 sheets
AB-1797	PP, PS, & PE	Clear Seal: Thin, clear polymer seal; Pierceable; Non-conductive	ALPS 25 and 50V	85 x 135	100 sheets

## Heat Seals, Rolls

Cat. No.	Plate Material Types	Description	Compatible with:	Dimensions, mm x m	Packaging
AB-3559	PP	Thermo Seal: Foil laminate; Very strong seal; Excellent chemical resistance; Recommended for use with DMSO, the robust sealing option	ALPS 3000	78 x 370	1 roll
AB-3686	PP	Clear Seal: Strong, clear polyester-polypropylene seal cannot be peeled or pierced; Optically transparent for sample inspection	ALPS 3000	78 x 610	1 roll
AB-3720	PP & PE	Easy Pierce: 20 µm Thin foil for excellent pierceability, including multiple seals for repeated sealing	ALPS 3000	78 x 610	1 roll
AB-3738	PP & PE	Easy Pierce: Easily pierced foil material for PP, PE and PCR; Accepts secondary foil application for re-sealing; Good chemical compatibility; Ideal for use with DMSO	ALPS 3000	78 x 610	1 roll
AB-3739	PP, PE & CCC	Easy Peel: Foil laminate for long-term storage; Good for low temperatures to -200°F; Can be easily removed and a new seal applied	ALPS 3000	78 x 610	1 roll
AB-3797	PP, PS, & PE	Clear Seal: Thin, clear polymer seal; Pierceable; Non-conductive; For Use with the ALPS 3000; 78 mm x 610 m roll	ALPS 3000	78 x 610	1 roll
AB-3799	PP, PS, PE & CCC	Diamond Seal: Clear polymer seal; Peelable seal with excellent optical clarity	ALPS 3000	78 x 370	1 roll



DOMINIQUE DUTSCHER SAS



© 2014 Thermo Fisher Scientific Inc. All rights reserved. Excel and Microsoft are registered trademarks of Microsoft Corp. All other trademarks are the property of Thermo Fisher Scientific Inc. and its subsidiaries.

[www.thermoscientific.com](http://www.thermoscientific.com)

**ANZ:** Australia: +61 1300 735 292; New Zealand: +64 0800 933 966

**Asia:** China: +86 400 650 5118; India: +91 22 6716 2200; India Toll-free: 800 22 8374

Japan: +81 3 5826 1616; Other Asian countries: +65 68729717

**Europe:** Austria: +43 1 801 40 0; Belgium: +32 53 73 42 41; Denmark: +45 4631 2000; France: +33 2 2803 2180

Germany: +49 6184 90 6940; Germany Toll-free: 08001 536 376; Italy: +39 02 02 95059 or +39 434 254 375

Netherlands: +31 76 571 4440; Nordic/Baltic countries: +358 9 329 100; Russia/CIS: +7 812 703 42 15

Spain/Portugal: +34 93 223 09 18; Switzerland: +41 44 454 12 12; UK/Ireland: +44 870 609 9203

**North America:** USA/Canada +1 585 586 8800; USA Toll-free: +1 800 625 4327

**South America:** USA sales support: +1 585 899 7198

**Countries not listed:** +49 6184 90 6940 or +33 2 2803 2180

CTLSPPPLATEGUIDE 0914

**Thermo**  
SCIENTIFIC

Part of Thermo Fisher Scientific