



User Guide

SNAP i.d.<sup>®</sup> 2.0

Protein Detection System  
for Western Blotting



## Notice

The information in this document is subject to change without notice and should not be construed as a commitment by EMD Millipore Corporation ("Millipore") or an affiliate. Neither EMD Millipore Corporation nor any of its affiliates assumes responsibility for any errors that may appear in this document.

Made in U.S.A.  
EMD Millipore Corporation  
290 Concord Rd.  
Billerica, MA 01821

© 2014 EMD Millipore Corporation, Billerica, MA, U.S.A. All rights reserved.

The M logo, Millipore, SNAP i.d., Immobilon, Millex, bløk, Probumin, and Novagen are registered trademarks of Merck KGaA, Darmstadt, Germany.

Luminata, Visualizer, Re-Blot, BLOT-QuickBlocker, and Cytobuster are trademarks of Merck KGaA. All trademarks of third parties are the property of their respective owners.

00000825, Rev. B, 06/14

## Contents

Introduction.....	1
SNAP i.d. <sup>®</sup> 2.0 Protein Detection System Features.....	1
Parts and Functions of the SNAP i.d. <sup>®</sup> 2.0 System.....	2
Symbols Used in this User Guide.....	3
Materials Required but Not Supplied.....	3
General Guidelines.....	4
Optimization Guidelines.....	4
Antibodies.....	4
Blot Blocking.....	7
How to Use the SNAP i.d. <sup>®</sup> 2.0 System.....	9
System Setup.....	9
Blot Assembly and General Protocol.....	10
Extended Primary Antibody Incubation: One Hour to Overnight.....	12
Antibody Recovery.....	12
Proof of Performance.....	14
Maintaining the SNAP i.d. <sup>®</sup> 2.0 System.....	17
Cleaning Protocol.....	17
Component Re-use.....	17
Troubleshooting.....	18
Specifications.....	20
Chemical Compatibility.....	21
Storage.....	21
Ordering Information.....	22
Conformance to Pressure Equipment Directive.....	24
Technical Assistance.....	24
Standard Warranty.....	24

## Introduction

The new and improved SNAP i.d.<sup>®</sup> 2.0 Protein Detection System is the second generation of the SNAP i.d.<sup>®</sup> method for detecting immunoreactive proteins on Western blots. With this unique vacuum-driven system, the length of time required for immunodetection is greatly reduced. What previously took 4 to 24 hours with traditional Western blotting methods now takes only 30 minutes with no loss of signal intensity or reduction in blot quality. All immunodetection steps after protein transfer to a membrane (i.e., blocking, washing, and primary and secondary antibody incubations) can be performed with the SNAP i.d.<sup>®</sup> 2.0 system.

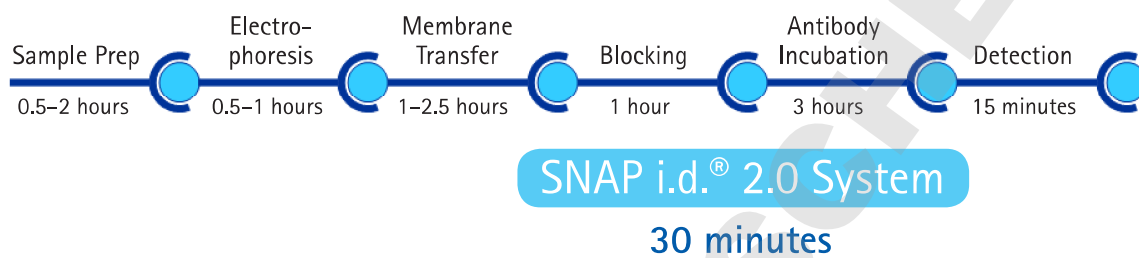

## SNAP i.d.<sup>®</sup> 2.0 Protein Detection System Features

- Processing of up to four blots at a time on a vacuum base with two individually controlled sides
- Three removable blot holding frame sizes: MultiBlot, Mini, and Midi, to accommodate different blot sizes
- Disposable blot holders, sized for MultiBlot, Mini, and Midi frames
- Blot spacer required with first generation SNAP i.d.<sup>®</sup> system is now integrated into the new blot holder
- Extended and off-line blot processing options: frames have lids and can be removed from the base for extended incubation (one hour to overnight), incubation in a shaker, or incubation at 4 °C
- Stackable frames so multiple blots can be processed at the same time
- 30-minute immunodetection with uniform signal across the blot
- Greater than 80% antibody recovery using the SNAP i.d.<sup>®</sup> 2.0 Antibody Collection Trays
- Compatible with nitrocellulose and polyvinylidene fluoride (PVDF) membranes
- Works with the most blocking buffers and visualization methodologies (e.g. chemiluminescence, fluorescence, or colorimetric)

The SNAP i.d.<sup>®</sup> 2.0 Protein Detection System is intended for research use only. It is not for use in diagnostic procedures.

## Parts and Functions of the SNAP i.d.<sup>®</sup> 2.0 System



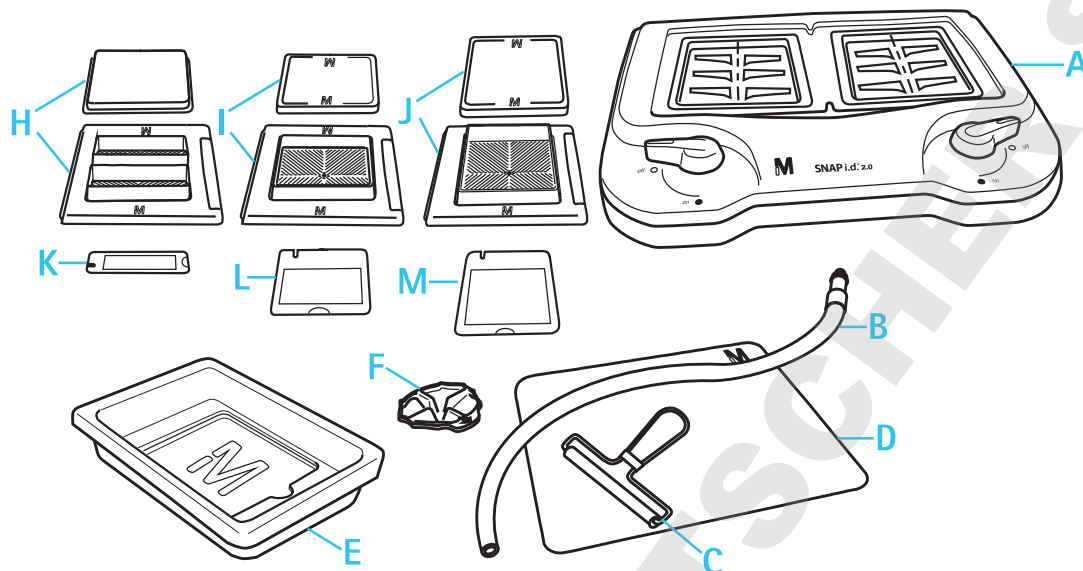



The SNAP i.d.<sup>®</sup> 2.0 system consists of the following components:



Part	Function	Cat. No.	
	SNAP i.d. <sup>®</sup> 2.0 Base Kit (includes the following components)	SNAP2BASE	
A	Base Unit (1)	Accepts frames and facilitates immunodetection	
B	Tubing Assembly Kit (1)	Connects system to vacuum source	
C	Blot roller (1)	Eliminates air bubbles between the blot and blot holder	
D	Rolling pad (1)	Provides smooth surface for assembling blot	
E	Wetting tray (2)	Used for wetting out blot holder and blot	
F	Antibody Collection Tray (2)	Collects antibody for recycling	
G	Quick Start Guide (not shown)		
H	SNAP i.d. <sup>®</sup> 2.0 MultiBlot Holding Frame and Lid	Accepts MultiBlot holders for blot incubation	SNAP2FRMB01
I	SNAP i.d. <sup>®</sup> 2.0 Mini Blot Holding Frame and Lid	Accepts Mini blot holders for blot incubation	SNAP2FRMN01 SNAP2FRMN02
J	SNAP i.d. <sup>®</sup> 2.0 Midi Blot Holding Frame and Lid	Accepts Midi blot holders for blot incubation	SNAP2FRMD01 SNAP2FRMD02
K	SNAP i.d. <sup>®</sup> 2.0 MultiBlot Holder (includes 2 MultiBlot well blanks)	Accepts up to 4.5 x 8.4 cm blots Blank is used to block empty chamber when running only one blot	SNAP2BHMB050
L	SNAP i.d. <sup>®</sup> 2.0 Mini Blot Holder	Accepts up to 7.5 x 8.4 cm blots	SNAP2BHMN0100
M	SNAP i.d. <sup>®</sup> 2.0 Midi Blot Holder	Accepts up to 8.5 x 13.5 cm blots	SNAP2BHMD0100

## Symbols Used in this User Guide

The following symbols are used throughout this user guide and/or on product labels, and the user shall abide by indicated requirements:

Symbol	Definition	Symbol	Definition
	Warning alerts you to actions that may cause personal injury or pose a physical threat.		Lot number
	Read the documentation		Manufacturer
	Catalogue number		Do not re-use
	Serial number		

## Materials Required but Not Supplied

- Vacuum source: Pump or other uniform vacuum source that can deliver a sustained minimum pressure of 410 millibar (12 in. Hg) and 34 L/min. Refer to Ordering Information for pump catalogue numbers.

**NOTE:** EMD Millipore Corporation's WP61 series Chemical Duty Pumps can be used, but may require longer processing times.

- One liter or larger vacuum flask with stopper (for waste collection). A Millex®-FA<sub>50</sub> filter (or equivalent) is recommended between the vacuum flask and the vacuum source to protect the vacuum source from contamination.
- Vacuum tubing to connect vacuum flask to vacuum source
- Forceps
- Blocking reagent such as non-fat/low fat dry milk (0.5% or less), casein, bovine serum albumin (BSA) or other commercially available blocking agents such as bløk®-CH buffer (see Table 5)
- Antibodies (monoclonal and/or polyclonal)
- Detection reagents
- Wash buffer: tris- or phosphate-buffered saline solution, pH 7.4, supplemented with Tween® 20 surfactant (TBST or PBST)
- Blot with transferred proteins

Blot Holder Size	Maximum Blot Size (cm)
MultiBlot	4.5 x 8.4
Mini	7.5 x 8.4
Midi	8.5 x 13.5

## General Guidelines

- If proteins have been transferred to PVDF membrane that has been dried out, re-wet the blot with 100% methanol, then rinse with distilled water prior assembly. If proteins have been transferred to nitrocellulose membrane that has been dried out, re-wet the blot with distilled water.
- For most applications and for most antibodies, a 0.5% solution of non-fat/low fat dry milk provides sufficient blocking of the membrane.  
**NOTE:** Do not use dry milk concentrations higher than 0.5% because it can cause clogging of the blot holder membrane. If using other blocking solutions, refer to Table 5 for compatibility and recommended concentration.
- Always use 0.1% Tween® 20 surfactant in the washing, blocking, and antibody buffers. This will reduce the surface tension of solutions and ensure even distribution of the antibody in the blot holder during incubation.
- Since immunodetection in the SNAP i.d.® 2.0 system is performed in a short period of time, it is recommended that primary and secondary antibody dilutions be prepared prior to starting the procedure.
- The total volume of diluted antibody required is 2.5 mL for the MultiBlot holder, 5 mL for the Mini blot holder, and 10 mL for the Midi blot holder.
- Four washes of 30 mL each (15 mL for MultiBlot) are needed to ensure the complete wash of the blot after each incubation step. Refer to Table 2 for details.
- Stripping blots in the SNAP i.d.® 2.0 system is not recommended. Blots that have been stripped outside of the system following a standard protocol can be reprobed in the SNAP i.d.® 2.0 system starting with the blocking step.
- If stripping is not required (for example, if detecting with a different secondary antibody), blots can be reprobed immediately in the SNAP i.d.® 2.0 system after a quick wash.

## Optimization Guidelines

### Antibodies

Optimization guidelines have been developed to enable users to convert the antibody concentrations used in standard immunodetection assays into concentrations applicable to the SNAP i.d.® 2.0 system. Most users will be able to use the same amount of antibody, but in less volume at a higher concentration than for standard immunodetection. However, when using the extended antibody protocol (page 12), it is possible to use the same concentration, volume, and time for the primary antibody that is regularly used for standard immunodetection, followed by the secondary antibody at a higher concentration for a shorter period of time.

## Antibodies, continued

Table 1. How to calculate the antibody concentration required for the SNAP i.d.<sup>®</sup> 2.0 system based on the concentration used for standard immunodetection

	Standard Immunodetection	SNAP i.d. <sup>®</sup> 2.0 Immunodetection		
		MultiBlot	Mini Blot	Midi Blot
Ab stock concentration	1 mg/mL	1 mg/mL	1 mg/mL	1 mg/mL
Mass of antibody required	1 µg	0.25 µg	0.5 µg	1 µg
Volume of Ab used	30 mL	2.5 mL	5 mL	10 mL
Final Ab dilution	1 : 30,000	1 : 10,000	1 : 10,000	1 : 10,000
Antibody stock used	1 µL	0.25 µL	0.5 µL	1 µL

Because each antibody is unique, and the sensitivity of detection reagents varies, it may be necessary to adjust the antibody or antigen concentration, the type or sensitivity of the detection reagent used, or the blot X-ray exposure time. Please note that this guideline is intended as a starting point to develop the final antibody concentration for the desired performance.

Table 2. Blocking, Antibody, and Wash Recommended Volumes

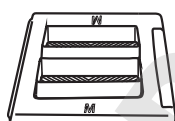

SNAP i.d.<sup>®</sup> 2.0  
MultiBlot Frame

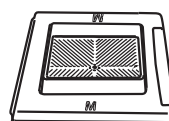

SNAP i.d.<sup>®</sup> 2.0  
Mini Frame

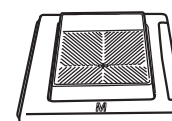

SNAP i.d.<sup>®</sup> 2.0  
Midi Frame

Blocking solution volume	15 mL per well	30 mL	30 mL
Antibody volume	2.5 mL per well	5 mL	10 mL
Wash buffer* volume	4 × 15 mL each per well	4 × 30 mL each	4 × 30 mL each

\* Tris- or phosphate-buffered saline solutions, supplemented with 0.1% Tween<sup>®</sup> 20 surfactant

When calculating the amount of antibody required for immunodetection, three components are critical for successful detection of the protein and a good quality blot (low background, high signal):

- Type of sample and concentration loaded on the gel
- Primary and secondary antibody concentration
- Type and sensitivity of the detection reagent

All of the antibodies in the following list were tested using Luminata<sup>™</sup> Forte chemiluminescence detection reagent. For the SNAP i.d.<sup>®</sup> 2.0 system, the antibody concentration is higher than in standard immunodetection, but in less volume.



## Antibodies, continued

Table 3. Examples of Primary Antibody Dilution in Standard Immunodetection vs. SNAP i.d.<sup>®</sup> 2.0 Immunodetection

**NOTE:** All antibodies were tested using 0.5% NFDM as the blocking reagent and Luminata™ Forte Western HRP Substrate as the chemiluminescent reagent.

Primary Antibody <sup>a</sup>	Host <sup>b</sup>	Cat. No.	Protein MW	Standard Ab dilution	SNAP i.d. <sup>®</sup> 2.0 Ab dilution
Anti-Akt1/PKB $\alpha$	Rb	05-796	60	1:1,200–1:2,000	1:400
Anti-CREB	Rb	06-863	43	1:600–1:1,000	1:200
Anti-Caspase-3	Rb	AB3623	17	1:1,200–1:2,000	1:400
Anti-Cyclin D1	Rb	04-1151	36	1:600–1:1,000	1:200
Anti-EGFR	M	05-104	170	1:600–1:1,000	1:200
Anti-MAP Kinase 1/2 Erk1/2	Rb	06-182	44–42	1:1,500–1:2,500	1:500
Anti-erbB2	M	04-291	185	1:600–1:1,000	1:200
Anti-GAPDH	M	MAB374	38	1:30,000–1:50,000	1:10,000
Anti-GST M1 (mu)	Rb	ABN19	26	1:600–1:1,000	1:200
Anti-GFAP	M	MAB3402	50	1:1,200–1:2,000	1:400
Anti-Glutamate receptor 1	Rb	AB1504	100	1:1,200–1:2,000	1:400
Anti-Huntington protein	M	MAB2166	350–400	1:1,200–1:2,000	1:400
Anti-Integrin $\alpha$ 5	Rb	AB1928	114	1:3,000–1:5,000	1:1,000
Anti-MGluR5	Rb	AB5675	132	1:600–1:1,000	1:200
Anti-NFkB p52	Rb	06-413	100 & 52	1:1,200–1:2,000	1:400
Anti-NMDAR1	Rb	AB9864	120	1:1,200–1:2,000	1:400
Anti-P53 (N-term)	Rb	04-1083	53	1:600–1:1,000	1:200
Anti-pan-Cadherin	Rb	ABT35	120–130	1:1,200–1:2,000	1:400
Anti-PP2A	M	05-421	36	1:3,000–1:5,000	1:1,000
Anti-PTEN	M	04-035	55	1:600–1:1,000	1:200
Anti-Pyk2	Rb	06-559	114	1:600–1:1,000	1:200
Anti-Ras	M	05-516	21	1:1,500–1:2,500	1:500
Anti-Rac1	M	05-389	21	1:600–1:1,000	1:200
Anti-STAT1	M	05-987	91	1:300–1:500	1:100
Anti-Tau1	M	MAB3420	52–68	1:1,200–1:2,000	1:400
Anti- $\beta$ -Tubulin	M	MAB3408	50	1:3,000–1:5,000	1:1,000

<sup>a</sup> Go to [www.millipore.com/antibodies](http://www.millipore.com/antibodies) for details

<sup>b</sup> M = Mouse, Rb = Rabbit

## Antibodies, continued

Table 4. Examples of Secondary Antibody Dilution in Standard Immunodetection vs. SNAP i.d.<sup>®</sup> 2.0 Immunodetection

Secondary Antibody <sup>a</sup>	Host <sup>b</sup>	Cat. No.	Standard Ab dilution	SNAP i.d. <sup>®</sup> 2.0 Ab dilution
Anti-Mouse IgG	Gt	AP124P	1 : 50,000	1 : 10,000
Anti-Rabbit IgG	Gt	AP132P	1 : 200,000	1 : 30,000
Anti-Sheep IgG	Rb	AP147P	1 : 50,000	1 : 20,000
Anti-Goat IgG	Rb	AP106P	1 : 80,000	1 : 10,000

<sup>a</sup> Horseradish peroxidase conjugate

<sup>b</sup> Gt = Goat, Rb = Rabbit

## Blot Blocking

- The SNAP i.d.<sup>®</sup> 2.0 system is compatible with most commonly used blocking agents including non-fat/low fat dry milk, bovine serum albumin (BSA) and casein. Many other commercially available blockers are also compatible (refer to Table 5).
- In order to ensure optimal flow through the blot holder, it is essential that blocking solutions be completely solubilized and free of all particulate matter. In some cases, it may be necessary to reduce the concentration of the blocking agent to achieve the required flow.
- The use of non-fat/low fat dry milk at concentrations higher than 0.5% is not recommended.
- Blocking agents, should be prepared in tris- or phosphate-buffered saline solution containing 0.1% Tween<sup>®</sup> 20 surfactant, to reduce surface tension and ensure even distribution of blocking agent across the blot holder surface.
- To ensure even distribution of the antibody in the incubation step, dilute the antibody in blocking solution that contains Tween<sup>®</sup> 20 surfactant.

Table 5. Compatibility with Blocking Reagents

Blocker	Compatible	Recommended Concentration
Non-fat/low fat dry milk (NFDM)	Yes, ≤ 0.5%	0.5%
Immunoblot Blocking Reagent, NFDM (cat. no. 20-200)	Yes, ≤ 0.5%	0.5%
BLOT-QuickBlocker <sup>™</sup> Reagent (cat. no. WB57-175GM)	Yes	0.5%
bløk <sup>®</sup> -PO Buffer (cat. no. WBAVDP001)	Yes	Undiluted
bløk <sup>®</sup> -FL Buffer (cat. no. WBAVDL01)	Yes	Undiluted
bløk <sup>®</sup> -CH Buffer (cat. no. WBAVDCH01)	Yes	Undiluted
N-Z-Amine <sup>®</sup> AS (Fluka <sup>®</sup> )	Yes, ≤ 5%	1%
Probumin <sup>®</sup> Bovine Serum Albumin (BSA) (cat. no. 820473)	Yes, ≤ 5%	1%

## Blot Blocking, continued

Blocker	Compatible	Recommended Concentration
5% Alkali-soluble Casein (Novagen® cat. no. 70955)	Yes	1%
SEA BLOCK Blocking Buffer (Pierce®)	Yes	Undiluted
SuperBlock® Blocking Buffer with Tween® 20 surfactant (Pierce®)	Yes	Undiluted
LI-COR® Odyssey® Blocking Buffer	Yes	Undiluted
PVP-40 (Polyvinylpyrrolidone)	Yes, ≤ 1%	1%
Gelatin	No	N/A

# How to Use the SNAP i.d.<sup>®</sup> 2.0 System

## System Setup

1. Place the SNAP i.d.<sup>®</sup> 2.0 base on a level bench top.
2. Attach the vacuum tubing to the back of the system by pushing the coupling insert on the end of the tubing into the quick disconnect fitting at the back of the system base until it clicks.

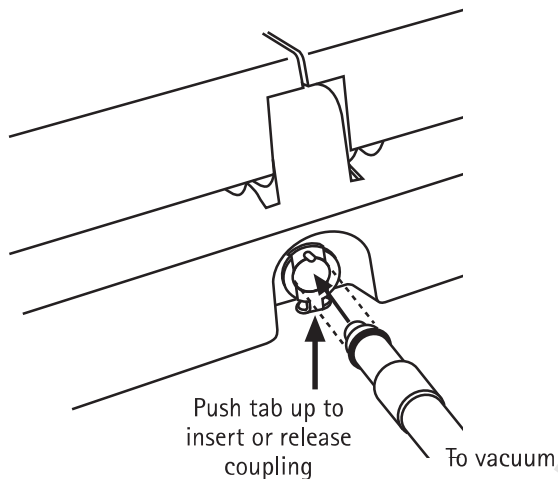

**NOTE:** To disconnect the tubing, push the tab below the tubing connector up with the index finger and pull tubing out.

3. Connect the other end of the tubing to a vacuum source. Use a one-liter vacuum flask as a trap and a Millex<sup>®</sup>-FA<sub>50</sub> filter (cat. no. SLFA05010) to protect the vacuum source from contamination, as shown below.

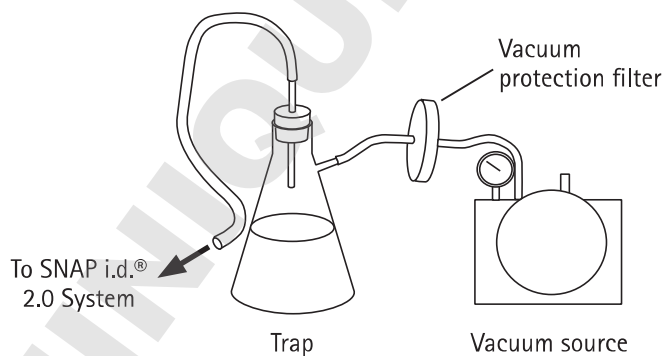

**NOTE:** Any vacuum source that can deliver 410 millibar (12 in. Hg) and 34 L/min is sufficient. If the vacuum source operates at higher than 410 millibar, the SNAP i.d.<sup>®</sup> 2.0 system will automatically regulate the vacuum pressure.

If the vacuum source is insufficient, the flow rate through the system may be inconsistent, resulting in longer processing times and/or poor antibody recovery.

## How to Use the SNAP i.d.<sup>®</sup> System, continued

### Blot Assembly and General Protocol

1. Hold the blot holder by the support layer (blue edges) and wet the membrane layer (white) with distilled water in the wetting tray provided. Do **not** wet the support layer. Place the wetted blot holder on the rolling pad.



2. If required, pre-wet the blot in methanol and water, then place it in the center of the blot holder with the **protein side down**.

**NOTE:** Blot should not exceed size specified in the Materials Required section.

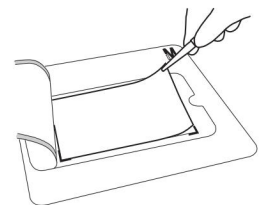

3. Roll the blot gently to remove air bubbles, then close the blot holder and roll one more time.

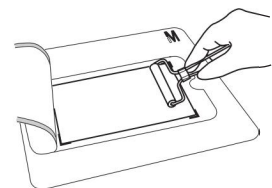

4. Open the blot holding frame, flip the blot holder so that it is **protein side up**, then place it inside the frame. A notch in the blot holder ensures correct placement in the frame.

**NOTE:** If running only one MultiBlot in the frame, place the well blank card in the second well.

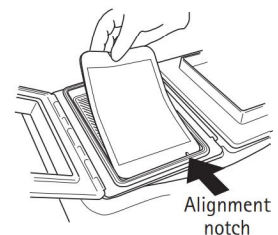

5. Close and lock the frame. Add 30 mL of blocking solution (15 mL for MultiBlot). Press the frame down and turn the system knob to apply vacuum. When frame is completely empty, **TURN VACUUM OFF**.



**NOTE:** If using antibody recovery trays, insert trays after step 5. For details, refer to Antibody Recovery section.

## Blot Assembly and General Protocol, continued

6. Apply appropriate volume of primary antibody across the surface of the blot holder (2.5 mL for MultiBlot, 5 mL for Mini blot, or 10 mL for Midi blot).

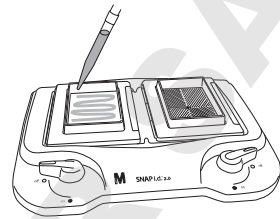

7. Incubate for 10 minutes at room temperature. Solution will be absorbed into the blot holder and surface may appear dry.

**IMPORTANT:** Do not apply vacuum until after the 10-minute incubation.

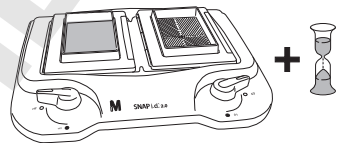

8. Press the frame down and apply vacuum. Wait 5–8 seconds until the frame is completely empty.

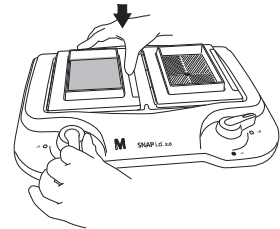

9. With vacuum running continuously, add 30 mL of wash buffer (15 mL for MultiBlot). Repeat the washing step 3 more times (total of 4 washes). When frame is completely empty, **TURN VACUUM OFF.**

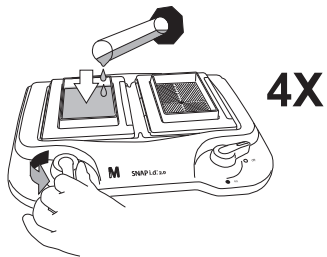

10. Apply appropriate volume of secondary antibody across the surface of the blot holder (2.5 mL for MultiBlot, 5 mL for Mini blot, or 10 mL for Midi blot). Incubate for 10 minutes at room temperature with vacuum off. Again, solution will be absorbed into the blot holder and surface may appear dry.

**IMPORTANT:** Do not apply vacuum until after the 10-minute incubation.

11. Press frame down and apply vacuum. Wait 5–8 seconds until frame is completely empty. With vacuum running continuously, add 30 mL of wash buffer (15 mL for MultiBlot). Repeat the washing step 3 more times (total of 4 washes).
12. Turn vacuum off and remove blot holder from frame. Remove blot from blot holder and incubate with the appropriate detection reagent. If the MultiBlot well blank was used, remove and clean.

## Extended Primary Antibody Incubation: One Hour to Overnight

1. Perform steps 1 through 5 of the General Protocol.
2. Add 2.5 mL (for MultiBlot), 5 mL (for Mini blot), or 10 mL (for Midi blot) of 1X primary antibody (concentration normally used during standard immunodetection).
3. Cover the blot holding frame with the lid. If desired, remove it from the base and incubate with constant shaking. If overnight incubation is required, refrigeration is recommended. Although the surface of the blot holder may look partially dry, the blot will not dry out, since the solution is contained in the frame.

**NOTE:** If processing more than one blot for extended period of time, the blot holding frames can be stacked to reduce the working space.

**Optional:** If recovering primary antibody, place antibody recovery tray(s) into base before proceeding to step 4.

4. After the extended incubation period, place the frame back on the base, remove the lid, and follow steps 8 through 12 of the General Protocol.

**NOTE:** Extended incubation periods for the secondary antibody are not required for the SNAP i.d.<sup>®</sup> 2.0 System. A 5X concentration of secondary antibody for 10 minutes is recommended.

## Antibody Recovery

1. Perform steps 1 through 5 of the General Protocol, but increase the vacuum time to 2 minutes to ensure that all the blocking solution has been removed from the grooves and channels of the frame.
2. Remove the blot holding frame from the base and wipe any residual liquid from the bottom of the frame with a paper towel.
3. Place the antibody collection tray(s) into the base, making sure that the positioning holes in the antibody collection tray line up with the positioning pins in the base.

**NOTE:** For Mini and Midi frames, position a single collection tray in the center of the base. For the MultiBlot frame, position two collection trays as shown in the diagram.

When running a single blot in the MultiBlot frame, place a well blank card in the empty well and position the collection tray below the well with the blot.



## Antibody Recovery, continued

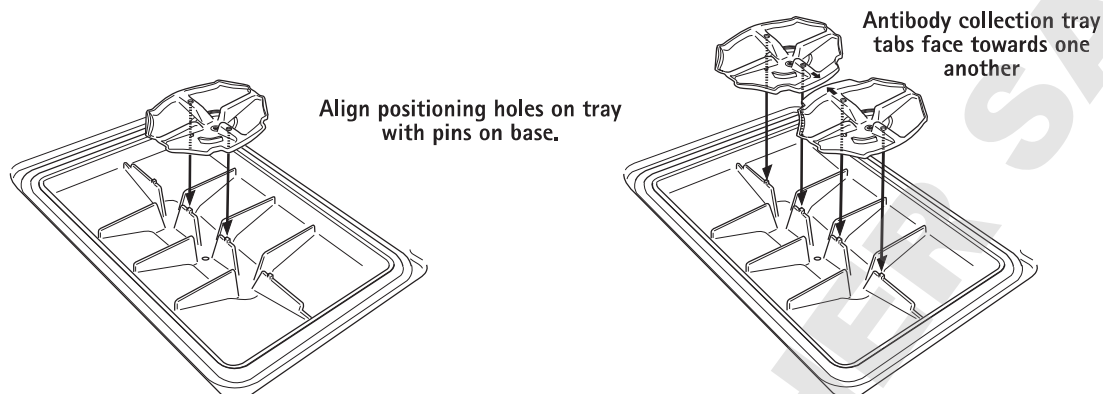

SNAP i.d.<sup>®</sup> 2.0 Mini and Midi Frames

SNAP i.d.<sup>®</sup> 2.0 MultiBlot Frame

4. Place the blot holding frame back into position on the base.
5. Apply primary antibody and incubate as indicated in steps 6 and 7 of the General Protocol.
6. After the 10-minute incubation, turn the vacuum on and wait one minute to ensure that all of the antibody has been collected.

**NOTE:** When processing two frames at the same time, apply vacuum first to one side, then to the other. This ensures full vacuum force on each frame and improves volume recovery.

7. Turn the vacuum off and remove the frame. Remove the antibody collection tray.
8. Transfer the antibody to a suitable container for storage or analysis.
9. Place the blot holding frame back into position and continue with step 9 of the General Protocol.



## Proof of Performance

Figure 1. Immunodetection of  $\beta$ -Tubulin:

SNAP i.d.<sup>®</sup> 2.0 System vs. SNAP i.d.<sup>®</sup> System (first generation) vs. Standard Immunodetection

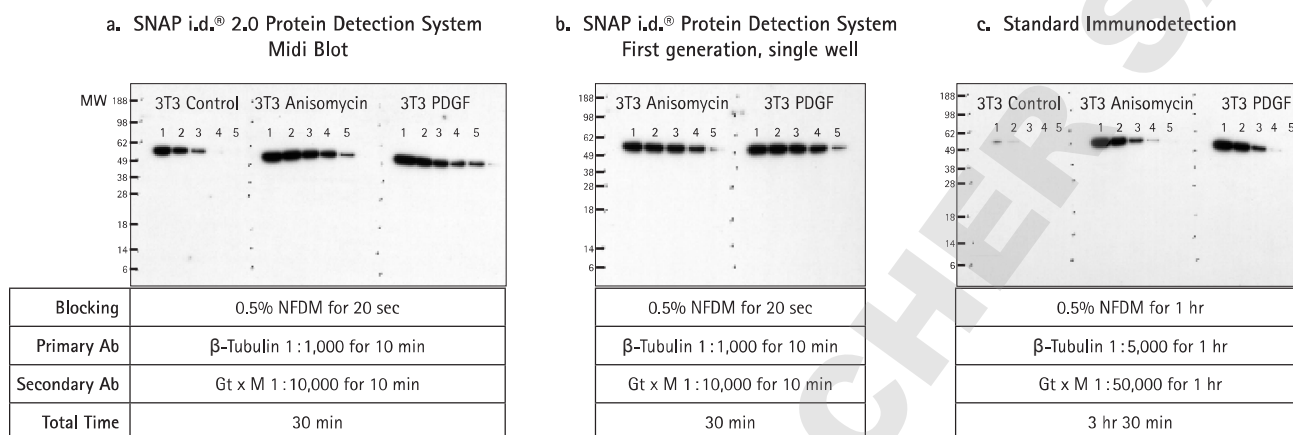

Control, anisomycin-treated, and PDGF-treated 3T3 mouse fibroblast cell lysates (10-0.63  $\mu$ g) were transferred to Immobilon<sup>®</sup>-P membrane. Blots were blocked with 0.5% non-fat dry milk (NFDM) prepared in tris-buffered saline supplemented with 0.1% Tween<sup>®</sup> 20 surfactant (TBST), and probed with primary anti- $\beta$ -Tubulin (MAB3408) and secondary HRP-conjugated goat anti-mouse (AP124P) at the conditions indicated above. Blots were exposed to X-ray film for one minute.

Lane	Concentration ( $\mu$ g)
1	10
2	5
3	2.5
4	1.25
5	0.63

Figure 2. Immunodetection of erbB2:

SNAP i.d.<sup>®</sup> 2.0 System vs. SNAP i.d.<sup>®</sup> System (first generation) vs. Standard Immunodetection

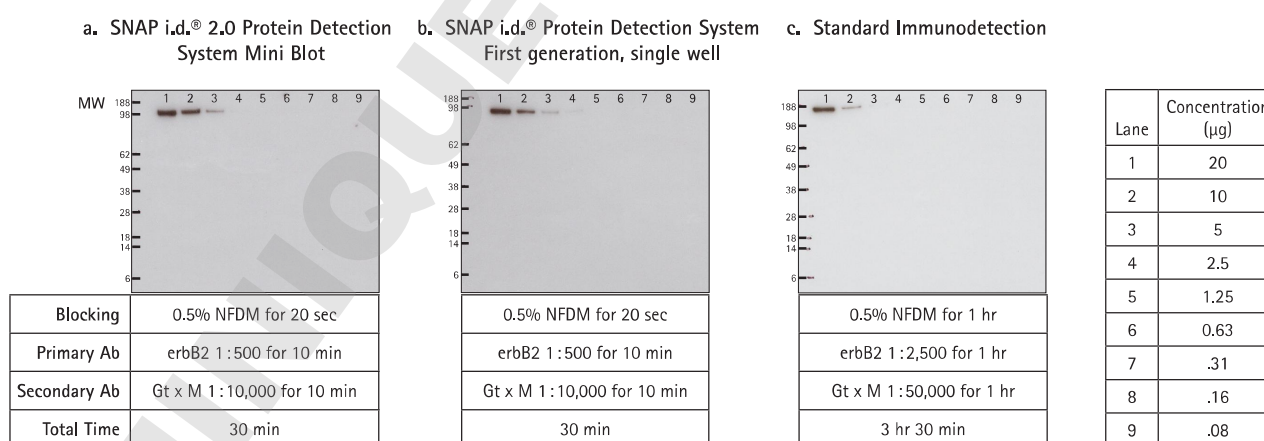

A431 EGF stimulated cell lysate (20 to 0.08  $\mu$ g) was transferred to Immobilon<sup>®</sup>-P membrane. Blots were blocked with 0.5% NFDM prepared in TBST, and probed with primary anti-erbB2 (04-291) and secondary HRP-conjugated goat anti-mouse (AP124P) at the conditions indicated above. Blots were exposed to X-ray film for 5 minutes.

## Proof of Performance, continued

Figure 3. Immunodetection of Tau-1 protein:  
SNAP i.d.<sup>®</sup> 2.0 System (MultiBlot, Midi, and Mini) vs. Standard Immunodetection

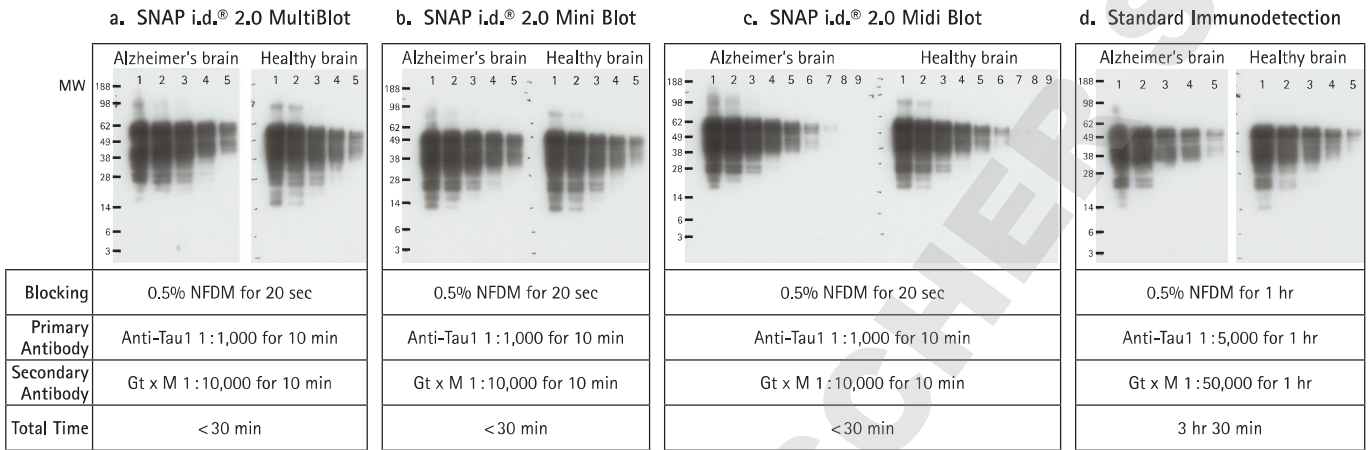

Human brain samples from an Alzheimer's patient and from a healthy donor were lysed in Cytobuster™ Protein Extraction Reagent (cat. no. 71009). Samples were serially diluted and separated by SDS gel electrophoresis. Gels were transferred to Immobilon®-P membrane. Blots were processed in the SNAP i.d.<sup>®</sup> 2.0 system using MultiBlot, Mini, and Midi frames with their corresponding blot holders. A control blot was processed by standard immunodetection. All blots were blocked with 0.5% NFDM and probed with primary anti-Tau1 (cat. no. MAB3420) and secondary HRP-conjugated goat anti-mouse (AP124P) at the conditions indicated above. Blots were incubated with Luminata™ Forte HRP substrate and exposed to X-ray film for 15 minutes.

MultiBlot, Mini Blot, and Standard Immunodetection		Midi Blot	
Lane	Concentration (µg)	Lane	Concentration (µg)
1	20	1	20
2	10	2	10
3	5	3	5
4	2.5	4	2.5
5	1.25	5	1.25
		6	0.63
		7	.31
		8	.16
		9	.08

## Proof of Performance, continued

Figure 4. Extended Incubation (Overnight):  
SNAP i.d.<sup>®</sup> 2.0 System vs. Standard Immunodetection

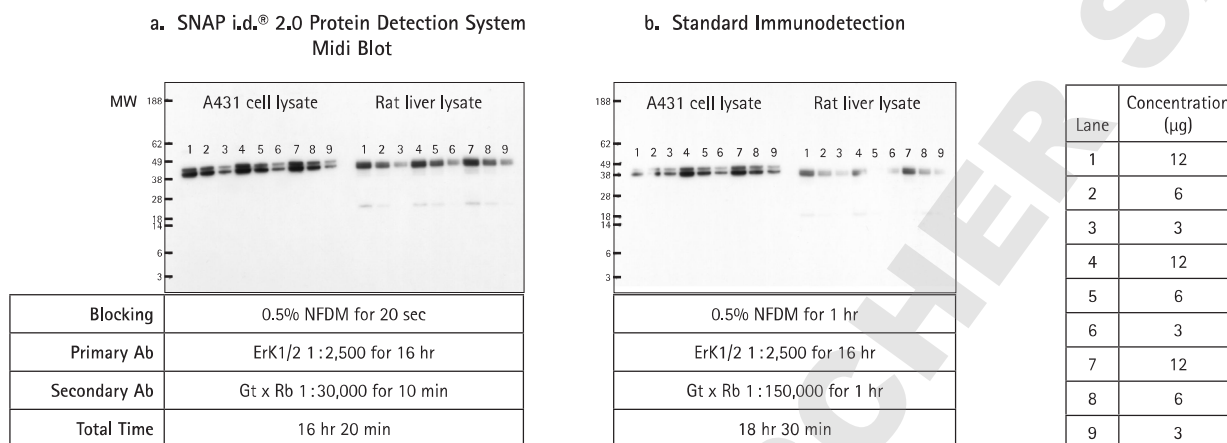

A431 cell lysate and rat liver lysate (12 to 3 µg) were transferred to Immobilon<sup>®</sup>-P membrane. Both blots were blocked with 0.5% NFDN prepared in TBST. The SNAP i.d.<sup>®</sup> 2.0 Midi blot was blocked for 20 seconds and the standard blot was blocked for 1 hour. Both blots were incubated overnight with the same dilution of MAP-Kinase 1/2 (ErK1/2), however, for the secondary antibody, HRP-conjugated goat anti-rabbit (AP132P), the SNAP i.d.<sup>®</sup> 2.0 blot was incubated for 10 minutes and the standard blot was incubated for 1 hour after 3 washes in TBST.

Figure 5. Extended Incubation (1 Hour):  
SNAP i.d.<sup>®</sup> 2.0 System 1 Hour Protocol vs. SNAP i.d.<sup>®</sup> 2.0 System Standard Protocol vs. Standard Immunodetection

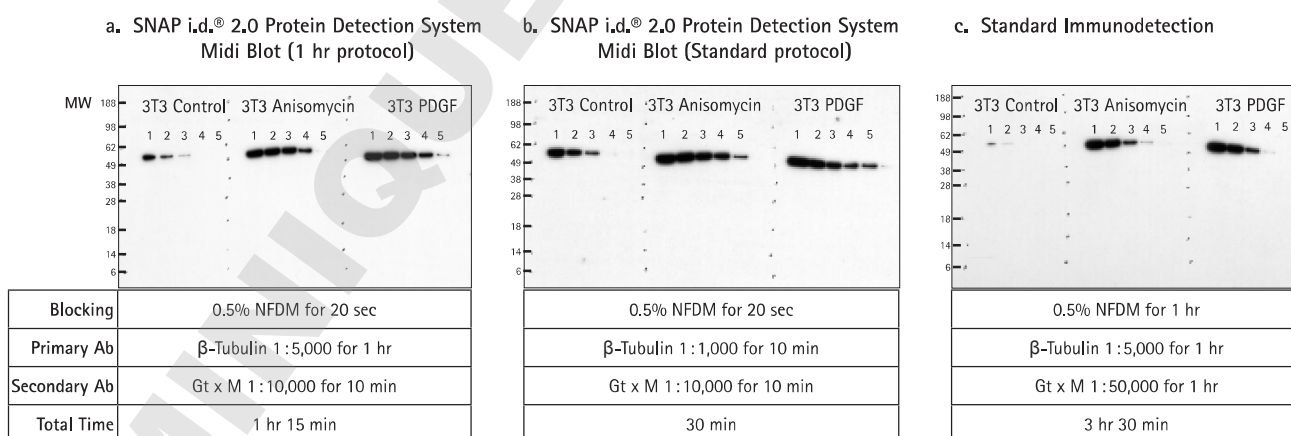

Control, anisomycin-treated, and PDGF-treated 3T3 mouse fibroblast cell lysates (10–0.63 µg) were transferred to Immobilon<sup>®</sup>-P membrane. Blots were blocked with 0.5% non-fat dry milk (NFDN) prepared in tris-buffered saline supplemented with 0.1% Tween<sup>®</sup> 20 surfactant (TBST), and probed with primary anti-β-Tubulin (MAB3408) and secondary HRP-conjugated goat anti-mouse (AP124P) at the conditions indicated above. Blots were exposed to X-ray film for one minute.

Lane	Concentration (µg)
1	10
2	5
3	2.5
4	1.25
5	0.63

## Maintaining the SNAP i.d.<sup>®</sup> 2.0 System

### Cleaning Protocol

The SNAP i.d.<sup>®</sup> 2.0 system should be cleaned after each use. To remove salts or contaminants from the base and tubing, turn the vacuum on and flush distilled water through the system.

**NOTE:** Do not autoclave the SNAP i.d.<sup>®</sup> 2.0 system.

Frames can be disassembled and washed with a mild detergent, then rinsed thoroughly with distilled water and air dried.

To disassemble the frame, orient it with the blue clamp on the right side. Unclamp the frame, and using both hands, open it like a book, while gently pushing the left half down and the right half up. When the frame is almost completely open, the two halves will slide apart. Take care not to lose the small O-ring located on one of the center pins.

To reassemble the frame, reverse the procedure above. It may take slightly more force to engage the two halves, since the O-ring is being compressed.

**NOTE:** The purpose of this O-ring is to keep the frame cover opened when placing the blot in the frame. The frame is fully functional without the O-ring.

### Component Re-use

Blot holders and antibody collection trays are **single-use only**. Re-use increases the risk of blot holder clogging and uneven signal across the blot, as well as sample cross-contamination.

Refer to applicable international, federal, state, and local regulations for appropriate disposal.

## Troubleshooting

Symptom	Cause	Corrective Action
Vacuum control knobs stick	Inadequate cleaning	Flush system with distilled water.
Blot holders do not empty or empty slowly when vacuum is applied	Inadequate vacuum	Make sure tubing connection between system and vacuum source is secure.
	MultiBlot frame was used to process a single blot, and well blank card was not placed in empty well	When running a single blot in the MultiBlot frame, place well blank card in empty well.
	Inadequate cleaning	Make sure all system gaskets and valve at center of frame are clean and free of debris or salt.
		Empty the vacuum flask and change the in-line Millex®-FA filter.
Blot holder may be clogged due to: Concentration of non-fat/low fat dry milk too high Incompatible blocking solution Re-use of blot holder	Use 0.2–0.5% dry milk in buffer supplemented with 0.1% Tween® 20 surfactant, with a new blot holder. Change to a different blocking solution with a new blot holder. Blot holders are intended for single use. Do not re-use.	
Low signal or signal lower than in standard immunodetection	Primary and/or secondary antibody concentration too low	Increase the antibody concentration 5 to 8-fold.
	Blot upside down	Mark the protein side of the blot and make sure that this side is facing the membrane side of the blot holder.
	Detection reagent not sensitive enough	Change to a higher sensitivity detection reagent such as Luminata™ Forte Western HRP Substrate.
High background	Inadequate blocking	Change to different blocking solution.
	Blot holder not wet enough	Pre-wet the blot holder before assembly.
	Blocking solution may have degraded	Always prepare fresh 0.5% non-fat/low fat dry milk.
	Antibody concentration too high	Decrease the concentration of antibody.
	Blot holder was placed upside down in the frame	Place blot holder in frame protein side up.
	Inadequate washing	Run at least 4 washes of 30 mL each.
Make sure vacuum is running continuously while adding wash buffer.		

## Troubleshooting, continued

Symptom	Cause	Corrective Action
Inconsistent signal across the blot	System not level	Make sure system is on a flat, level surface.
	Antibody not applied evenly across entire surface of blot holder	Supplement blocking solution and antibody diluent with 0.1% Tween® 20 surfactant.
		Use a small volume pipette (e.g., 5 mL) and slowly distribute the antibody across the entire blot.
Low antibody volume recovery	Antibody recovery trays not placed correctly in base	Apply at least 2.5 mL (for MultiBlot), 5 mL (for Mini blot), or 10 mL (for Midi blot) of antibody.
	Two frames processed simultaneously	Make sure that the holes in the antibody recovery tray align with the pins in the base.
	MultiBlot frame was used to process a single blot, and well blank card was not placed in empty well	Apply vacuum first to one frame, then to the other, to ensure full vacuum force on each frame.
		When running a single blot in the MultiBlot frame, place well blank card in empty well.

## Specifications

### Dimensions

Base (length x width x height)	40.6 x 32.4 x 8.9 cm (16 x 12.75 x 3.5 in.)
Weight (approximate)	1.5 kg (3.3 lb)
MultiBlot frame with lid (length x width x height)	19.7 x 14.7 x 3.6 cm (7.75 x 5.8 x 1.4 in.)
MultiBlot holder	11.4 x 6.4 cm (4.5 x 2.5 in.)
Mini frame with lid (length x width x height)	19.7 x 14.7 x 3.6 cm (7.75 x 5.8 x 1.4 in.)
Mini blot holder	12.7 x 9.1 cm (5.0 x 3.6 in.)
Midi frame with lid (length x width x height)	19.7 x 14.7 x 3.6 cm (7.75 x 5.8 x 1.4 in.)
Midi blot holder	17.8 x 10.2 cm (7.0 x 4.0 in.)
Antibody tray (length x width x height)	6.4 x 5.8 x 1.9 cm (2.5 x 2.3 x 0.75 in.)

### Materials of Construction

#### System

Base and top	Acrylonitrile butadiene styrene (ABS)
Gaskets	Silicone
Tubing	Silicone
Tubing fittings	Polypropylene or acetal with ethylene propylene diene monomer (EPDM) or Buna-N seals

#### Frames

Top and bottom	ABS
Latch	ABS
Gaskets	Silicone
Valve	EPDM
Lid	Polystyrene

#### Blot holder

Membrane layer	PVDF with high impact polystyrene (HIPS)
Support layer	Polypropylene with patapar

#### Accessories

Roller	Acetal and stainless steel
Rolling pad	Polyester, HIPS, and acrylic
Antibody collection tray	Styrene butadiene copolymer
Wetting tray	Polyethylene terephthalate glycol (PETG)

## Chemical Compatibility

The SNAP i.d.<sup>®</sup> 2.0 Protein Detection System is compatible with aqueous solutions and dilute acids and bases. Do not expose to organic solvents.

## Storage

Store all components at room temperature.

DOMINIQUE DUTSCHER SAS



## Ordering Information

This section lists catalogue numbers for the SNAP i.d.<sup>®</sup> 2.0 system and associated products. See Technical Assistance section for contact information. You can purchase these products on-line at [www.millipore.com/products](http://www.millipore.com/products).

Product Description	Cat. No.	Qty/Pk
<b>Base System</b>		
<b>SNAP i.d.<sup>®</sup> 2.0 Base</b> Base unit (1) Tubing assembly kit (1) Blot roller (1) Rolling pad (1) Wetting trays (2) Antibody collection trays (2) Quick-Start Guide (1)	SNAP2BASE	1
<b>Components for Western Blotting Procedures</b>		
<b>SNAP i.d.<sup>®</sup> 2.0 MultiBlot Holding Frame</b> MultiBlot frame with lid (1) MultiBlot holders (2)	SNAP2FRMB01	1
<b>SNAP i.d.<sup>®</sup> 2.0 Mini Blot Holding Frame (single pack)</b> Mini frame with lid (1) Mini blot holders (2)	SNAP2FRMN01	1
<b>SNAP i.d.<sup>®</sup> 2.0 Mini Blot Holding Frames (double pack)</b> Mini frame with lid (2) Mini blot holders (4)	SNAP2FRMN02	1
<b>SNAP i.d.<sup>®</sup> 2.0 Midi Blot Holding Frame (single pack)</b> Midi frame with lid (1) Midi blot holders (2)	SNAP2FRMD01	1
<b>SNAP i.d.<sup>®</sup> 2.0 Midi Blot Holding Frames (double pack)</b> Midi frame with lid (2) Midi blot holders (4)	SNAP2FRMD02	1
<b>SNAP i.d.<sup>®</sup> 2.0 MultiBlot Holders (includes 2 well blanks)</b>	SNAP2BHMB050	50
<b>SNAP i.d.<sup>®</sup> 2.0 Mini Blot Holders</b>	SNAP2BHMN0100	100
<b>SNAP i.d.<sup>®</sup> 2.0 Midi Blot Holders</b>	SNAP2BHMD0100	100
<b>SNAP i.d.<sup>®</sup> 2.0 Antibody Collection Tray</b>	SNAPABTR	20
<b>SNAP i.d.<sup>®</sup> Blot Roller</b>	SNAP2RL	1

## Ordering Information, continued

Product Description	Cat. No.	Qty/Pk
<b>Blotting Membranes</b>		
Immobilon®-P PVDF, 0.45 µm, 26.5 x 3.75 cm roll	IPVH00010	1
Immobilon®-P PVDF, 0.45 µm, 7 x 8.4 cm sheet	IPVH07850	50
Immobilon®-P PVDF, 0.45 µm, 8.5 x 13.5 cm sheet	IPVH08130	10
Immobilon®-FL PVDF, 0.45 µm, 26.5 x 3.75 cm roll	IPFL00010	1
Immobilon®-FL PVDF, 0.45 µm, 7 x 8.4 cm sheet	IPFL07810	10
Immobilon®-PSQ PVDF, 0.2 µm, 7 x 8.4 cm sheet	ISEQ07850	50
Immobilon®-P PVDF Sandwich, 0.45 µm, 7 x 8.4 cm	IPSN07852	20
Immobilon®-P PVDF Sandwich, 0.45 µm, 8.5 x 13.5 cm	IPSN08132	20
<b>Reagents for Western Blotting</b>		
Luminata™ Forte Western HRP Substrate	WBLUF0500	500 mL
Luminata™ Crescendo Western HRP Substrate	WBLUR0500	500 mL
Luminata™ Classico Western HRP Substrate	WBLUC0500	500 mL
Immobilon® Western HRP Substrate	WBKLS0500	500 mL
Visualizer™ Western Blot Detection Kit, mouse	64-201	1 kit
Visualizer™ Western Blot Detection Kit, rabbit	64-202	1 kit
Calbiochem® TMB, insoluble	613548	100 mL
Calbiochem® SignalBoost™ Immunoreaction Enhancer Kit	407207	1 kit
Immunoblot Blocking Reagent	20-200	20 g
Re-Blot™ Plus Strong Antibody Stripping Solution, 10X	2504	50 mL
bløk®-CH Buffer	WBAVDCH01	500 mL
bløk®-FL Buffer	WBAVDFL01	500 mL
bløk®-PO Buffer	WBAVDP001	500 mL
BLOT-QuickBlocker™ Reagent	WB57-175GM	175 grams
Probumin® Bovine Serum Albumin	820473	100 g
Novagen® 5% Alkali-soluble Casein	70955	225 mL
<b>Components For Immunohistochemistry (IHC) Procedures</b>		
SNAP i.d.® 2.0 Immunohistochemistry Frame	SNAP2FRIHC	1
SNAP i.d.® 2.0 IHC Slide Holder	SNAP2SH	24

## Ordering Information, continued

---

### Accessories

Filter forceps, blunt end, stainless steel	XX6200006P	3
Vacuum filtering flask, 1 L	XX1004705	1
High Output Pump, 115 Volts, 60 Hz	WP6211560	1
High Output Pump, 100 Volts, 50/60 Hz	WP6210060	1
High Output Pump, 220 Volts, 50 Hz	WP6222050	1
Vacuum tubing, 6.4 mm ID x 3 m (1/4 in. ID x 10 ft)	MSVMHTS09	1
Millex®-FA filter unit, 1.0 µm, hydrophobic PTFE, 50 mm	SLFA05010	10

---

### Antibodies

Primary and secondary antibodies

go to [www.millipore.com/antibodies](http://www.millipore.com/antibodies)

## Conformance to Pressure Equipment Directive

The SNAP i.d.® 2.0 system does not fall within the scope of Pressure Equipment Directive 97/23/EC (PED), therefore, conformance to this directive is not applicable.

## Technical Assistance

For more information, contact the office nearest you. In the U.S., call 1-800-221-1975. Outside the U.S., go to our web site at [www.millipore.com/offices](http://www.millipore.com/offices) for up-to-date worldwide contact information. You can also visit the tech service page on our web site at [www.millipore.com/techservice](http://www.millipore.com/techservice).

## Standard Warranty

The applicable warranty for the products listed in this publication may be found at [www.millipore.com/terms](http://www.millipore.com/terms) (within the "Terms and Conditions of Sale" applicable to your purchase transaction).