

AD030 Air and fluid particle monitoring guide





DOMINIQUE DUTSCHER SAS

Table of Contents

I. Introduction 1

SAMPLING GUIDELINES	2
Fluid Sample Collection	2
Surface Sample Collection	2

ANALYTICAL METHODS FOR DETERMINATION OF PARTICLE CONTAMINATION	2
--	---

SAMPLING APPARATUS	3
Filters	3
Filter Holders	3

II. Air and Gas Monitoring 4

APPLICATIONS	4
Gas Lines	4

REGULATIONS	5
-------------------	---

SAMPLING AND FILTRATION	5
-------------------------------	---

AIR MONITORING EQUIPMENT	5
Filter Holders	5
Flow-Limiting Orifices	6
Filters	6

GENERAL AIR SAMPLING IN WORK ENVIRONMENTS	6
Air Sample Collection	6
Air Sampling Procedures	7

PERSONAL SAMPLING FOR INDUSTRIAL HYGIENE	8
Sampling Point	8
Cassette Use	8
Personal Sampling Procedure	8

GAS LINES	9
Sampling Frequency	9

CLEAN ROOM GARMENTS	10
Sampling Procedure	10
Counting	10

III. Liquid and Component Monitoring 11

APPLICATIONS	11
--------------------	----

SAMPLE COLLECTION AND FILTRATION METHODS	12
Indirect Sampling Method	12
Direct Sampling Method	12
Gravimetric Method	12

EQUIPMENT	12
Sampling Bottles	12
Filter Holders	12
Sampling Kits	12

ON-LINE SAMPLE COLLECTION AND FILTRATION	13
Quick-Release Valve Installation.....	13
Monitoring Cassette Sampling Procedure	14
BATCH SAMPLE COLLECTION AND FILTRATION	15
Proper Cleaning of Sample Containers.....	15
Location of Sampling Valves.....	16
Sample Collection	16
Filtration Equipment Preparation.....	17
Filtration Procedure.....	18
On-Site Analysis Patch Test Kit Collection and Filtration	19
COMPONENTS MONITORING	21
Tubing and Hoses Sampling.....	21
Small Valves and Manifolds Sampling	21
Large Valves and Fittings Sampling	21

IV. Analysis **22**

OPTICAL MICROSCOPE PARTICLE COUNTING	22
Filter Clearing.....	23
Equipment	24
Particle Counting.....	26
SCANNING ELECTRON MICROSCOPE PARTICLE COUNTING	28
Sample Preparation	28
Calibration	28
Particle Size and Counting	28
PARTICLE GRAVIMETRIC ANALYSIS	29
Filter Selection.....	29
Sample Preparation for Gravimetric Analysis.....	30
Weighing and Calculation.....	31
PARTICLE IDENTIFICATION	32
Optical Microscopy	32
Other Methods.....	32
COLORIMETRIC PATCH METHOD	33

V. Typical Contamination Levels **34**

HYDRAULIC FLUIDS	34
ISO® 4406 HYDRAULIC FLUID CLEANLINESS CODES	35
AIRCRAFT FUELS	35
UNITED STATES MILITARY	
LAND-BASED HYDRAULICS	36
UNITED STATES MILITARY AIRCRAFT HYDRAULICS	36
ROCKET PROPULSION & SERVICE FUELS*	36
AMBIENT AIR	36
CLEANROOM GARMENTS	36

VI. Filter Selection 37

MF-MILLIPORE™ (MIXED CELLULOSE ESTERS) MEMBRANE FILTERS	37
Chemical Compatibility	37
Thermal Stability	37
Matched-weight Membranes	37
ISOPORE™ TRACK-ETCHED (PC) MEMBRANE FILTERS	38
Surface Retention Characteristics	38
Track-Etched Membranes for Particle Analysis	38
FLUOROPORE™ AND MITEX™ (PTFE) MEMBRANE FILTERS	38
Chemical Compatibility	38
Thermal Stability	38
SILVER MEMBRANE FILTERS (PURE SILVER)	38
DURAPORE® (POLYVINYLIDENE FLUORIDE) MEMBRANE FILTERS ...	39
Broad Chemical Compatibilities	39
PVC MEMBRANE FILTERS	39
GLASS FIBER FILTERS WITHOUT BINDERS	39
Type AP40 Microfiber Glass Discs (for analysis only) without Binder Resin	39
Type AP10 Absorbent Pads	39
Type AP30 Thick Support Pads	39

VII. Air and Fluid Monitoring Applications Guide 40

VIII. Appendix 53

AEROSOL ANALYSIS CASSETTES, 25 MM	53
Aerosol Analysis	54
FLUID CONTAMINATION ANALYSIS CASSETTES, 37 MM	55
Contamination Analysis	55
Matched-Weight Cassettes	55
FLUID SAMPLING KIT	56
Applications	56
Specifications	56
PATCH TEST KIT	57
Applications	57
Specifications	57
THE FILTER HOLDER VISUAL DICTIONARY	58
FEATURED PRODUCTS FOR ENVIRONMENTAL PARTICLE MONITORING METHODS	59
Aerosol Analysis Monitors	59
FILTERS FOR AMBIENT AIR MONITORING	59
PARTICLE COUNTING SOLUTIONS FOR CONTROLLED ENVIRONMENTS	60
Award-winning safety:	60
Transportable safety:	60

DOMINIQUE DUTSCHER SAS

I. INTRODUCTION

Particle contamination is of special interest in several industries, because of its impact during processing, manufacturing, packaging, and transportation of products, especially in systems with electronic and mechanical components. Further, checking particle levels in hydraulic systems or aircraft fuel is of critical interest. The levels of particle contamination that are tolerated in these systems are extremely low and must be monitored. Particle volume and size factor into how well and how long a system will operate. Large particles cause a system to break down faster than small particles, but a large number of small particles can also cause premature system failure. Fluids and fluid streams that are routinely monitored include fuels, gases, hydraulic oils, lubricants, water, chemicals, precision component rinses, cleaning tanks, boilers, and pharmaceutical products. Routine analysis of clean room environments, building abatements, and worker safety in an industrial environment relies on methodology for particle analysis of air.

This manual was designed to help you monitor air and fluids in the workplace. We manufacture a variety of analytical tools for collecting, identifying, and measuring particles in the air during a manufacturing process or for determining worker exposure by personal air monitoring. Prolonged workplace and environmental exposure to airborne contaminants have been linked to a number of occupational diseases. National and international regulatory agencies have established standard methods of analysis and set threshold limits for a large number of liquid and airborne contaminants. Merck Millipore has specialized in providing products for occupational and environmental monitoring for over 40 years and continues to meet today's demanding standards.

This manual references recommended NIOSH, OSHA and ASTM® methods for monitoring contamination using Merck Millipore filters. These methods incorporate the use of filter collection of particles for analysis by a variety of techniques, including but not restricted to gravimetric, atomic absorption (AA), spectrophotometric, inductively coupled plasma (ICP) and HPLC-UV analysis. Nearly every particle-monitoring situation poses special problems and requirements that cannot be foreseen or covered adequately in a single publication. This manual, therefore, provides essential elements of procedures and techniques that can be used by analysts as a point of departure in developing their own standard procedures.



SAMPLING GUIDELINES

In order to sample for particle contamination in any system (gases, liquids, or component surfaces), you can apply direct batch or online collection method using a membrane filter. You should reliably adhere to the same sampling procedure to ensure reproducible results. Sampling variables can be categorized as follows:

- **Sampling Cross-Contamination:** All sampling equipment, collection containers, analytical apparatus, and filters must be clean to use subsequent measurements as a valid index of the system you plan to test.
- **Sample Adequacy:** The number of samples, sample volume, and sampling time are dependent on the level of system contamination and the type of measurement you are performing. You must sample sufficient material to clearly measure "critical" levels of contamination. As an example, 100 mL would be representative of a high performance hydraulic system by microscopic particle counting; 1 to 5 gallons (4–20 Liters) would be a representative sample for gravimetric analysis of a turbine fuel system.

Fluid Sample Collection

The samples must represent the entire fluid system when the system is operating normally in order to obtain meaningful and reproducible data. You should take samples of viscous fluids from areas of high turbulence where particles are mixed throughout the fluid cross section. When you are sampling a static system and the system contents cannot be thoroughly mixed, take a multilevel sample.

Surface Sample Collection

You cannot remove all contaminating particles from a component surface by rinsing. It is important to use the same sampling (flushing) procedure every time you analyze the samples. The analytical results from such sampling do not indicate the total extent of surface contamination, but yield meaningful and reproducible data.

ANALYTICAL METHODS FOR DETERMINATION OF PARTICLE CONTAMINATION

There are many test procedures for particle contamination. Chapter VI briefly describes NIOSH, OSHA and ASTM® methods using filtration for sample collection, monitoring and preparation of particle and chemical contaminants. These procedures have been specifically designed for monitoring contaminants in the workplace and are dedicated to worker safety. The following analytical methods are described in detail:

- **Particle Counting:** A quantitative method for determining particle contamination by counting the particles on a filter through a microscope.
- **Gravimetric Analysis:** A quantitative method for determining contamination level by weight.
- **Patch Testing:** The Patch Test is a colorimetric, semi-quantitative method that allows for visual evaluation of contamination levels based on the characteristic color of the particle matter.

Spectroscopy, HPLC-UV and x-ray diffraction are methods that will not be described in this text but may be applicable.



SAMPLING APPARATUS

Most sampling techniques require filters, filter holders and a pump with vacuum or positive pressure.

Filters

You can use different types of filters for particle monitoring: membrane filters and depth filters (Figures 1 and 2). The membrane filter is a uniform, continuous mesh of polymeric material with defined pore size. These filters are available in nitrocellulose, nylon, polycarbonate, PTFE or PVC. The material type you use depends on its compatibility with the fluid you need to sample.

Depth filters have a matrix of randomly-oriented fibers pressed, wound, or bonded together into a random matrix of flow channels. Unlike membrane filters, depth filters have a nominal pore size, causing the filter to retain a range of particles during initial use. Due to the random orientation of fibers, depth filters do become saturated and eventually the pores become larger with use. Therefore, we recommend you use them for prefiltration or as a support pad in many of the monitoring procedures. Factors such as the size of the particles, fluid/filter compatibility, and the filtration method determine which filter you should use. Refer to Chapter VI for the proper monitoring method and the appropriate filters. You can also refer to the chemical compatibility guide at www.merckmillipore.com.

Filter Holders

In general, you use Merck Millipore particle-monitoring filters as discs with an underlying support to protect the filter against pressure differentials achieved during filtration. You can install or clamp filter discs in the filter holders between parallel sealing surfaces or gaskets. There are two types of Merck Millipore filter holders for use in contamination analysis:

- Reusable Filter Holders: We provide a variety of reusable filter holders constructed of stainless steel, glass or polypropylene for both liquid and atmospheric sampling. We recommend these holders for many procedures performed in a laboratory benchtop environment.
- Disposable Filter Holders: We also provide a variety of disposable filter holders depending on the specific method. Air monitoring cassettes are available in 25 and 37 mm diameters in a two- or three-piece configuration. Both cassette configurations are available preloaded or empty.

A wide range of filters in different pore sizes are available for these cassettes to meet both unique and standard sampling requirements. All cassettes are assembled in a clean room environment to minimize background particle contamination. For preloaded cassettes, the average background particle count has been determined and is marked on the outside of each package. Cassettes are also available with matched weight membranes to eliminate the need for preweighing test filters for gravimetric analysis.

The procedures described in this manual may involve hazardous materials, operations, and equipment. If you plan to follow these procedures, you are responsible for

establishing appropriate safety and health practices and determining the applicability of regulatory limitations before you begin. For example, if you use the Hydrosol™ Stainless Steel Filter Holder (Cat. No. XX2004720) for flammable liquids, you must ground it according to the directions provided with the product. The Hydrosol™ unit is fitted with a grounding screw and comes complete with a grounding lead fitted with an alligator clip.

▲ **WARNING: If you are filtering petroleum ether or other flammable solvents, you must ensure that the Hydrosol™ unit is grounded to prevent arcing from static electricity created during filtration.**

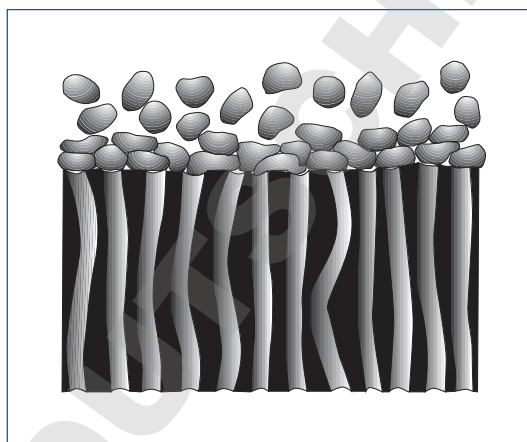

Figure 1. Schematic cross section, membrane filter. Particles are retained on surface.



Figure 2. Schematic cross section, depth filter. Random entrapment of particles.

II. AIR AND GAS MONITORING



APPLICATIONS

Workplace particle monitoring of air and gases serves multiple purposes. One important reason is that modern industrial processes, such as those involving gyroscopic, mechanical, servo, and electronic systems, are extremely sensitive to dust particles. Second, particle contamination can have a damaging effect on the downstream performance of highly sensitive products. Finally, heightened awareness of worker safety has led to increased monitoring of human exposure to certain particles in the work environment. Taken together, there is an acute demand for monitoring manufacturing and assembly areas, test laboratories, and clean rooms.

Industrial hygienists perform air monitoring for the analysis of hazardous particles, asbestos fibers, chemical vapors, and dust in work areas as well as on personal work clothes. We provide filters specified in the corresponding regulated methods. Also, we provide a two- or three-piece 37 mm monitoring cassette for sampling work areas and a 25 mm monitoring cassette with or without a cowl for personal sampling. (See Chapter VI.)

Gas Lines

Gas lines can be monitored using an in-line filter holder. The in-line filter removes the particles from the gas stream and, at regular intervals, you can remove the filter to analyze or monitor the contamination.

REGULATIONS

In the U.S., the EPA (Environmental Protection Agency) regulates environmental exposure while OSHA (Occupational Safety and Health Administration) regulates exposure in the workplace. NIOSH (National Institute of Occupational Safety and Health) develops the test methods in association with OSHA, the CDC (Center for Disease Control and Prevention) and the U.S. Department of Health and Human Services. When the EPA adopts a NIOSH standard method, it is referenced in the U.S. Federal Register. Chapter VI references NIOSH, OSHA and ASTM® methods. These organizations focus on the workplace and worker safety in developing their procedures. OSHA regulates exposure of over 100 air and fluid contaminants that can be monitored and sampled by membrane filtration.

In Europe, European Union Directives are published in the Official Journal of the European Union (OJEU). For example, the Asbestos International Association has published a comprehensive method in the OJEU for determination of asbestos in environmental and occupational settings. This method recommends monitoring asbestos through an Merck Millipore 25 mm all-conductive carbon-filled polypropylene cassette with cowl.

SAMPLING AND FILTRATION

In air monitoring and sampling procedures, air is drawn by vacuum through a 37 mm two- or three-piece cassette preloaded with the specified filter and support. In order to calculate the particles per unit volume of air, follow the steps:

1. Calculate total volume of air pumped (in liters):

$$\frac{L}{t} \times T = V$$

where L = liters (of air), t = unit of time and T = total sampling time (in units "t").

2. Measure the number of particles on the filter (P) by weight or direct counting, and complete the following equation:

$$\frac{P}{V} = \text{particles per liter of air}$$

For personal sampling, place the holder within the worker's breathing zone (cassette opening facing down) and connect through flexible vacuum tubing to a flow-controlled battery-operated pump attached to the worker's belt. Sampling is typically carried out long enough to represent a full work shift (minimum of 1/2 the full shift). Flow rate is usually 1 to 4 liters per minute, adjusted according to expected fiber and particle concentrations.

For area sampling, mount the holder vertically on a stand and direct toward a representative air space. Connect the holder to an appropriate vacuum pump through flexible vacuum tubing, and adjust the flow rate. If you use a threaded hose adapter (XX6200004), you can regulate the flow by inserting the appropriate flow-limiting orifice. We supply orifices in a matched set to monitor a range of flow rates.

AIR MONITORING EQUIPMENT

Air monitoring equipment consists of filter holders, flow-limiting orifices, and filters. See the following sections for details.

Filter Holders

Merck Millipore 47 mm stainless steel filter holders are designed for sampling large volumes of particles in air, such as those found in a large, dust-containing environment where protective clothing would be worn. These filter holders are available in an open configuration for maximum unimpeded flow in open atmosphere sampling, or a closed system with an inlet dispersion chamber for optimum particle distribution on the filter. In situations requiring extremely precise and/or sensitive particle detection, the filter holder must be precleaned and the filter precounted for background particles.

A 37 mm monitoring cassette is best for monitoring low particle volume in a clean environment. These cassettes have been precleaned during assembly with the average surface particle background count supplied with each lot.

To eliminate the need for preweighing test filters, matched-weight cassettes are also available for gravimetric analysis. Each of these cassettes contains two superimposed filters matched in weight to within 0.1 mg. These filters are available in 47 and 37 mm disc sizes.

While there are a variety of different sampling methods, the two basic air sampling procedures are personal sampling to determine individual worker safety and area sampling to determine the safety of the entire work environment.

Flow-Limiting Orifices

The flow-limiting orifice is a simple way to control flow rate. Insert the specific orifice into the threaded outlet (vacuum-connected) end of either a 47 mm filter holder (stainless steel) or an Merck Millipore aerosol adapter (stainless steel) when using a 37 mm contamination cassette. When you apply the required level of vacuum, air flows through the filter and orifice at a constant rate. The amount of vacuum required to maintain the correct flow rate for each orifice available is listed in Table 1. The applied vacuum must be equal to or greater than the specified level. The orifice is available in a two liter/min configuration for a constant flow rate, or a set of inlet pressures to monitor a range of flow rates.

Filters

The filters required for each air monitoring application depend on the contaminant. Pore size, filter compatibility and analytical method all play a part in filter choice. All Merck Millipore filters display high particle collection efficiency over a broad range of particle sizes. The most recommended filter is a 0.8 µm MF-Millipore™ cellulosic filter (filter code AA), which has been shown to retain essentially 100% of all airborne particles (>99.99%). Also, the binderless glass fiber (depth) filter has been shown to have a retention efficiency of >99% for a 0.3 µm aerosol of dioctylphthalate (DOP). We also offer PVC, PTFE, nylon, and silver filters to fit specific applications. For published NIOSH, OSHA and ASTM® procedures refer to Chapter VI to find the recommended filter.

GENERAL AIR SAMPLING IN WORK ENVIRONMENTS

The following section outlines air sampling techniques and includes a general discussion of collecting air samples and a description of specific procedures for air sampling using Merck Millipore filters, holders, and cassettes.

Air Sample Collection

Airborne particle contamination can vary significantly depending on the operations being carried out. To minimize sample variability, you should sample throughout an entire shift (approximately 8 hours). The final result reflects the average level of exposure. Alternatively, the sampling times can be short, sometimes only a few minutes, to deliberately measure how high the exposure is during specific dust-generating operations.

Orifice Flow Rate (L/min)	Minimum Required Vacuum		
	mm Hg	in. Hg	PSIG
1	300	12	6
2	300	12	6
3	300	12	6
4.9	400	16	8
10	500	20	10
14	550	22	11

Table 1. Vacuum required for function of flow-limiting orifices.

Air Sampling Procedures

37 mm Monitoring Cassette Method

1. Thread the flow-limiting orifice (if using one to control flow rate) into the barbed end of the aerosol adapter (Figure 4) and attach it to the vacuum hose.
2. Remove bottom (red) plug from three-piece transparent cassette and insert the Luer connector end of the aerosol adapter (Figure 5).
3. Remove top cover of cassette. Do not remove yellow plug.
4. Apply vacuum for specified time to collect sample (Figure 6).
5. After sampling, replace cassette cover before removing cassette from stand, to protect filter.
6. Send to lab for analysis.

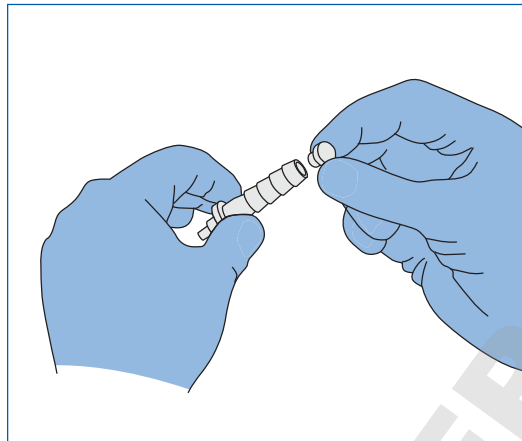

Figure 4. Place flow-limiting orifice into outlet of aerosol adapter.

47 mm Stainless Steel Monitor Method

1. Clean monitor thoroughly to reduce extraneous particles.
2. Perform a microscopic particle count or weigh the filter to determine baseline particle content. (Store filter in PetriSlide™ device until ready for use.)
3. Screw flow-limiting orifice into hose adapter and attach vacuum hose.
4. Place test filter, grid side-up, on support screen in base.
5. Lock filter into place using blue anodized locking ring.
6. Apply vacuum for specified time to collect sample.
7. Open filter holder, remove filter and return to PetriSlide™ device for subsequent evaluation. (See Chapter IV for analysis techniques.)

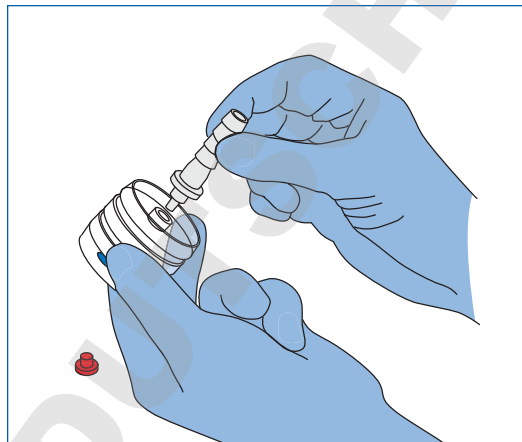

Figure 5. Insert Luer end of aerosol adapter into cassette outlet.



PetriSlide™ devices for microscopic analysis

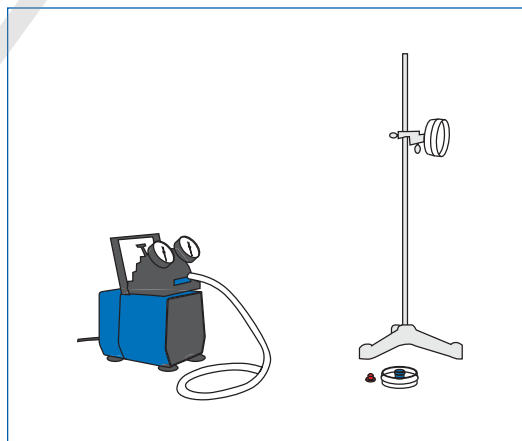

Figure 6. Sample air using 37 mm cassette connected to vacuum pump.

PERSONAL SAMPLING FOR INDUSTRIAL HYGIENE

This section describes the process of personal sampling for industrial hygiene, including how to choose the sampling point and the correct cassette.

Sampling Point

Place the cassette, open filter surface facing down, in the worker's breathing zone so that the air sampled will be representative of what the worker actually inhales.

Cassette Use

Depending on the reference method, use the cassette with either a closed or open face. An open-faced cassette (inlet cover removed) allows uniform particle or fiber distribution across the filter. With a closed-face cassette (inlet cover on), the air enters through the single hole at the center of the inlet cover. This technique is more commonly used for nuclear power plant applications.

The 37 mm monitoring cassette is available with a center ring. A two-piece configuration is commonly used for personal air sampling. This type of cassette can be installed in a cyclone sampler for gravimetric analysis of large dust particles, such as coal.

The 25 mm monitoring cassette is available either with a center ring or with a 50 mm conductive extension cowl. These configurations help to protect the membrane from inadvertent contamination, minimize static electricity, and ensure uniform particle or fiber distribution.

Personal Sampling Procedure Monitoring Cassette Method

1. Attach hose to cassette adapter (after removing plug and stand).
2. Attach hose to pump (Figure 7). If pump has been recently calibrated, go to step 4.
3. Preferably once a day, calibrate the pump. Connect a flow meter to the cassette inlet by removing the red plug in the cassette cover and inserting a connector attached to tubing (Figure 8). Alternatively, remove the cassette cover and place the cassette inlet over the flow meter outlet. Adjust the pump flow control screw (for personal sampling, 2 L/min is usually recommended).
4. Connect the cassette to clothing in the breathing zone (Figure 9).
5. Note the time and start the pump to collect sample.
6. At the end of the sampling period (commonly 8 hours for personal sampling), replace the inlet cover to protect filter and insert outlet plug.
7. Send to lab for analysis.

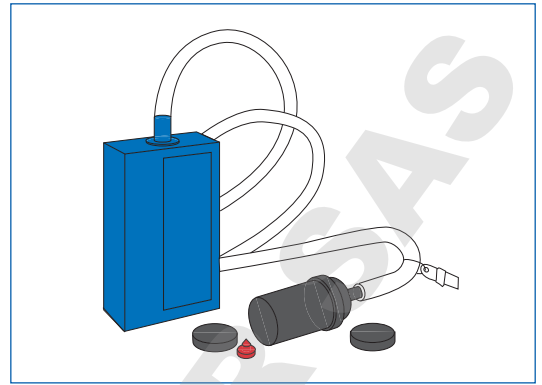

Figure 7. Aerosol cassette connected to personal sampling pump. Clothing clip fixed to tubing.

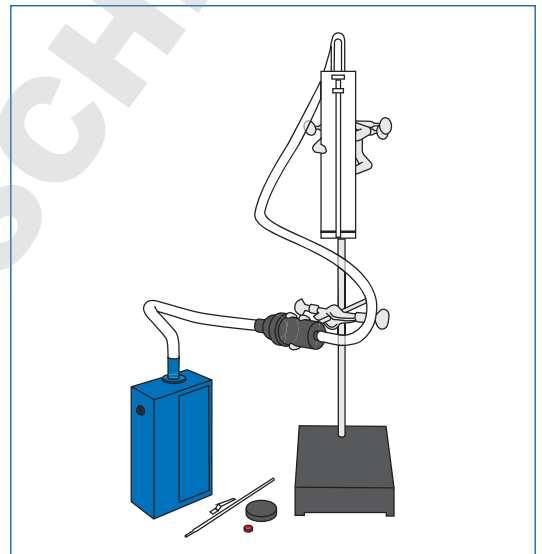

Figure 8. Calibrating personal sampling pump using 0-4 L/min flow meter with cassette connected in-line.

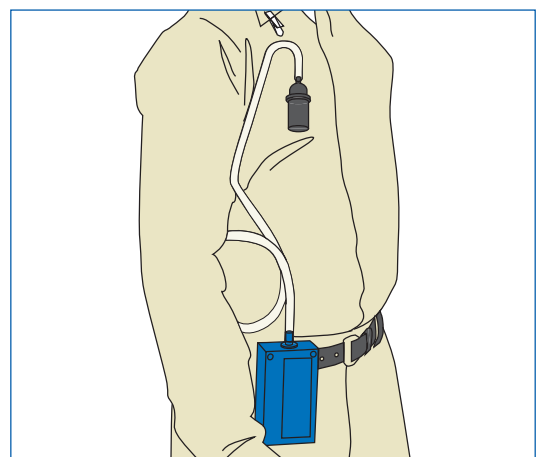

Figure 9. Cassette attached to worker's clothing in breathing zone. Personal sampling pump clipped to trouser belt.

GAS LINES

Gas Line Filter Holders are the best choice for in-line gas monitoring (Figure 10). The advantage of this holder is that you can remove the filter for further analysis without removing the holder from the line (Figure 11). For details on other filter holders, visit www.merckmillipore.com.

Sampling Frequency

Gas lines should be checked monthly or quarterly, depending on usage. You should also check gas lines during each line transfer to prevent cross contamination. For troubleshooting, monitoring for short periods (few hours) may be adequate. At the other extreme, you may change and analyze filters every three months on clean gas streams. A gas line filter prevents particle contamination in a clean outlet stream, which can be critical for highly sensitive instrumentation, such as gas chromatography or atomic absorption spectroscopy.

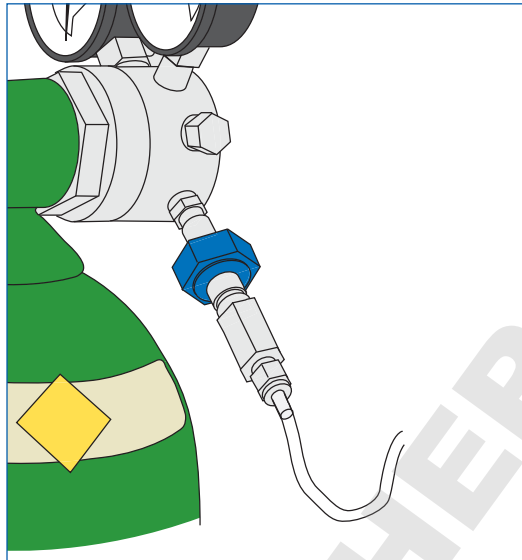

Figure 10. In-line sampling from compressed gas bottle with the 25 mm gas line filter holder.

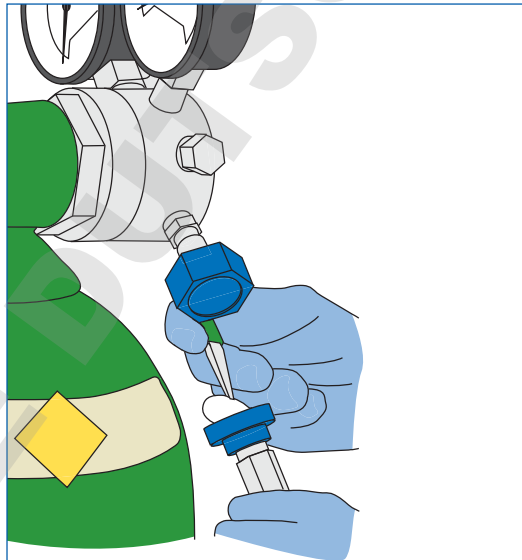

Figure 11. Removal of filter for analysis from gas line filter holder.

CLEAN ROOM GARMENTS

The procedure for sampling clean room garments requires that you draw filtered air through five designated 0,01 sq. ft. areas of a single thickness of the garment fabric at a rate of 14 liters per minute (L/min) for one minute per area. Loose particulate contaminants on or in the garment impinge on the surface of an Merck Millipore filter. Examine the filter under a microscope to determine the number of particles ($>5\ \mu\text{m}$ in diameter) removed from the garment.

Sampling Procedure

1. Screw the 14 L/min flow-limiting orifice into the filter holder outlet and connect the holder to a vacuum source (of at least 55 cm Hg at 14 L/min) using a hose.
2. Carefully place a Type AA black filter, grid side up, on the support screen in the filter holder base using clean forceps. Similarly place a Type SM white filter on top of the filter (Figure 12). Lock in place with the blue locking ring. When ready to sample, see step 3.
3. Place the outer surface of the test garment over the tapered (male) body of the holder. Secure the prefilter adapter assembly over the test portion of the fabric (Figure 13).
4. Apply vacuum and sample with the same filter for a period of one minute for each of the five test areas. Be sure to turn vacuum off after each test.
5. Open the filter holder, remove the sample filter, and place it on a PetriSlide™ device for subsequent counting. (See Chapter IV.)

Counting

For garment monitoring, it is customary to count and tabulate particles in two categories only:

1. All particles with the major dimension greater than $5\ \mu\text{m}$.
2. Fibers (longer than $100\ \mu\text{m}$ with a length-to-width ratio exceeding 10:1).

Each garment sampling area is 0,01 sq. ft. as defined by the clean room monitoring filter holder. Five sampling areas, therefore, provide a garment sample of 0,05 sq. ft. Multiply the total filter count by 20, for example, for 5 sample areas and report results in terms of particles per sq. ft. and fibers per sq. ft. of garment.

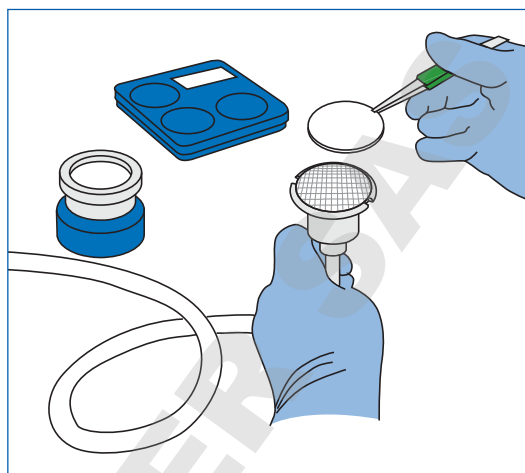

Figure 12. Filter is centered on base of garment monitoring holder. The prefilter is placed onto the filter

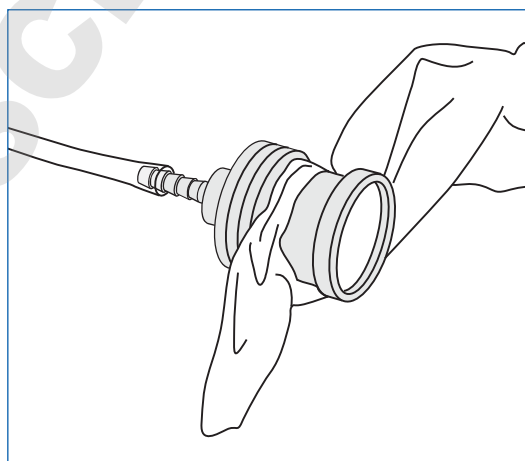

Figure 13. Test garment secured between prefilter adapter section (right), and the filter holder (left)

III. LIQUID AND COMPONENT MONITORING

APPLICATIONS

There are many points at which particles may contaminate industrial processes; therefore, particle monitoring is typically performed on a wide range of liquid samples.

Process water may contain particles present in the feed water or in-line contaminants resulting from corrosion and mechanical wear. The cleaning process of manufactured components contributes to particle contamination as well. Particles such as metal filings and joint compound and lubricating residues begin to accumulate in the fluid or feed water and eventually damage the final product.

The automotive and semiconductor industries have implemented quality control procedures for fluid particle monitoring and must be certified by many of their component suppliers. Particle contamination monitoring procedures are also in place for boiler feedwater and reactor cooling waters, which must be monitored for particle contamination prior to startup and at regularly scheduled intervals during normal operation.

Aviation fuels pick up particle contaminants all along the route from refinery to the aircraft. These particles commonly consist of fine sand, metal chips, metallic oxides, gums and resins common products of corrosion, scaling, vibration, and abrasion generated during the process.

Hydraulic fluids normally pick up particles as a result of oxidation and polymerization of the fluid itself during operation at high pressure and temperature. These contaminants consist of organic gums, varnishes and acids combined with other particles that can occur as a result of erosion and mechanical wear.



SAMPLE COLLECTION AND FILTRATION METHODS

Indirect Sampling Method

When using batch (indirect) sampling, collect the liquid in a container. Next, use the Merck Millipore Patch Test Kit to filter and analyze it on site, or send it to a laboratory for subsequent filtration and analysis. When performing indirect sampling, you must make sure that both the collection containers and the laboratory filter holders are clean to avoid unwanted contamination. This technique requires specific equipment preparation and laboratory testing. Therefore, we do not recommend it for critical applications, such as monitoring fuels, component systems, process waters or boiler water systems.

Direct Sampling Method

The direct sampling method, in which you filter your samples directly at the fluid inlet from a fuel or water line, is a simpler and more reliable procedure. The direct sampling method eliminates the possibility of introducing extraneous contamination from the sample containers.

If the liquid is under pressure (excess of 10 psi), you can filter your samples directly at the sampling point using an Merck Millipore sampler device, which contains a disposable two-piece filter cassette. Plug the sampler/cassette assembly into a quick-release sampling valve installed at the outlet of the system or storage tank. The operating pressure (100 psi max.) forces liquid through the assembly. The initial volume is directed through the valve and bypass hose to flush the sampler. The sample volume passes through the filter cassette into a graduated container attached to the sampler base.

After sampling, you may analyze the test filter on-site using a colorimetric method (Patch Test) or send it to the laboratory for more detailed analysis (e.g. particle counting or gravimetric analysis).

Gravimetric Method

Gravimetric analysis consists of preweighing a filter before use and then weighing it again after the sample has been filtered. The difference in the two weights determines the approximate particle content. Alternatively, using another method of gravimetric analysis, pass the sample through two preweighed filters placed in the same holder. For convenience, Merck Millipore matched-weight membranes are available as disc pairs or in preloaded transparent polystyrene cassettes. Each cassette contains two superimposed filters matched in weight to within 0.1 mg. As the sample passes through both filters, all the contaminants are retained on the upper test filter. The difference in the weights of the filters after drying is the weight of the contaminant in the sample. Using matched weight pairs eliminates the need to preweigh the filters and rules out any extraneous contamination of the test filter.

EQUIPMENT

This section outlines the equipment you will need to conduct particle monitoring in liquids.

Sampling Bottles

For field use, plastic bottles have an advantage over breakable glass bottles. When possible, bottles should be slightly larger than the sample volume and graduated on the outside. The Patch Test Kit for field use includes 120 mL transparent PVC bottles.

Filter Holders

a) Disposable filter holders

Fluid contamination filter cassettes are transparent, disposable filter holders that have been precleaned and preassembled. The cassettes are made of impact-resistant polystyrene and have been specifically manufactured for the filtration of fuels and hydraulic fluids. If you want to use them with any other chemical, please call Merck Millipore Technical Service or refer to the **Merck Millipore website** for product compatibility. Each box of monitoring cassettes has the average background particle count marked on each package. These 37 mm cassettes are available empty or preloaded with Merck Millipore filters and support pads.

b) Stainless steel and glass filter holders

25 and 47 mm glass or stainless steel holders are used for filtering liquids using vacuum. When filtering flammable liquids, you must use a stainless steel filter holder fitted with grounding wires. Merck Millipore fluid test kits, patch test kits, and 47 mm Hydrosol™ units all contain the required grounding capability.

▲ WARNING: If you are filtering petroleum ether or other flammable solvents, you must ensure that the stainless steel filter unit is grounded to prevent arcing from static electricity created during filtration.

Sampling Kits

We have developed sampling kits specifically designed for monitoring aviation and hydraulic fluids. These kits are also used in monitoring storage tanks, coolant waters, and some solvent cleaning tanks. (Check www.merckmillipore.com for compatibility information.)

ON-LINE SAMPLE COLLECTION AND FILTRATION

If the liquid you plan to test is under pressure (between 10 and 100 psi), you can filter the samples directly at the sampling point. To do this, use an Merck Millipore Sampler Assembly and a clean disposable Fluid Contamination Cassette containing an Merck Millipore filter. The Fluid Sampling Kit is portable and self-contained. The kit consists of a stainless steel sampler, the connecting valves and everything else needed for frequent on-site sampling in pressurized systems. Connecting valves and additional equipment are sold separately. Using the kit eliminates the need for sample bottle cleaning and prevents cross contamination.

Plug the sampler assembly, containing a cassette, into a stainless steel quick-release valve installed in the system line (Figure 14). The operating pressure (100 psi max.) forces liquid through the assembly. The initial volume is directed through a bypass line to flush the valve and inlet hose. The sample volume then passes through the filtering cassette and into a graduated container. Alternatively, you may transfer the fluid to a collection vessel by means of a sampling tube.

After sampling, either send the filter cassette to the laboratory for analysis or evaluate it on site using the appropriate method. Refer to Chapter VI for the proper monitoring method.

Quick-Release Valve Installation

Install the quick-release valve horizontally or on top of a pipe where there is a high velocity flow during flushing (Figure 15). We recommend a permanently installed quick release valve to avoid test variation and non-repeatability. Do not mount on the bottom of a pipe or tank where particles can collect and will not all be rinsed away with the initial flush. One stainless steel quick-release valve is supplied with the Fluid Sampling Kit (Figure 15). You can purchase additional valves and install them permanently at appropriate sampling points on systems throughout a given facility.

Once permanent sampling valves have been installed, an operator may tour the facility with the sampling kit and filter samples directly using a new filter cassette at each point.

When installing the quick-release valves:

- Do not omit the dust plug supplied with each valve.
- Regulate the pressure immediately upstream of the valve to a maximum of 100 psi if necessary.

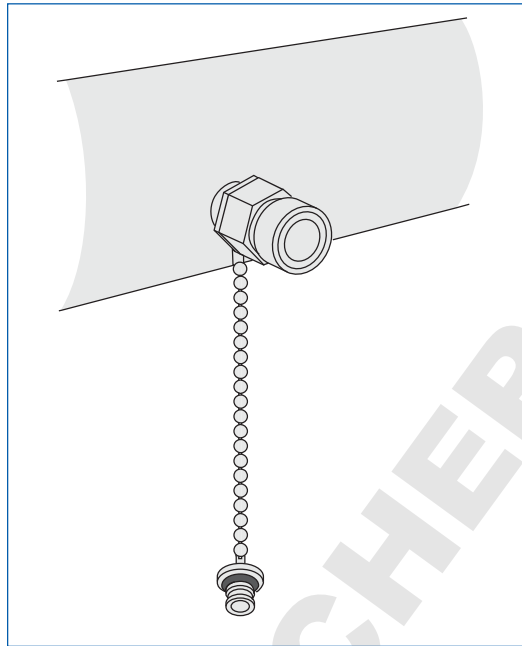

Figure 14. Quick disconnect valve fitted in horizontal position into piping.



Figure 15. Fluid sampling kit with contamination monitors

Monitoring Cassette Sampling Procedure

After installing the quick-release sample valves at the appropriate points in the system, use the following instructions for all analytical procedures performed using the Fluid Sampling Kit (Figure 15).

1. Unscrew the sampler. Remove the protective plugs from the 2-piece filter cassette and save the plugs for reuse (Figure 16). Install the cassette into the sampler with the filter facing up (Figure 17).

NOTE: We recommend MAWG037P0 or MABG037P0 contamination monitoring cassettes for direct particle analyses. For gravimetric analyses, we recommend the MAWP037PM matched weight cassettes to eliminate the need to preweigh the filters.

2. Screw the sampler tightly together. Connect the bypass hose from the three-way inlet valve to the hole in the side of the sampler (Figure 18).
3. Screw the hose with the grounding wire into the bottom of the sampling unit.
4. Place the three-way inlet valve in the "off" position and remove the dust caps from the quick-release sample valve and the inlet hose nipple. Retract the valve collar and insert the nipple firmly into the valve. Release the collar when the nipple is seated.
5. Place the outlet of the hose into a container. Turn the three-way valve to the "flush" position and allow fluid to flow through the bypass tubing to flush contaminants from the sampling valve, the hose and the three-way valve (typically about 100 mL for hydraulic fluids and one gallon [3.8 liters] for aircraft fuels).
6. Hold the sampler upright, turn the valve to the "test" position, and allow the desired sample quantity to flow through the cassette and into the graduated container. Turn the three-way valve to "off" when the desired sample volume has been collected.

CAUTION: Some pumping systems (e.g. aircraft refuelers) develop a vacuum when stopped, which can cause backflow and rupture the filter in the cassette. Always turn the sampler three-way valve to "off" before pumping is discontinued.

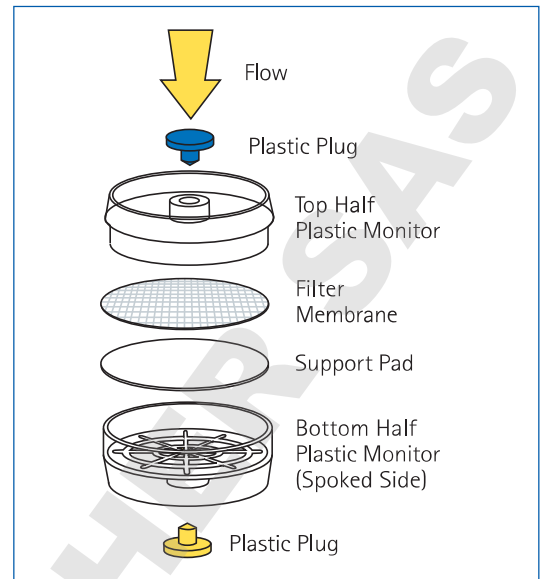

Figure 16. Two-piece preloaded monitoring cassette.

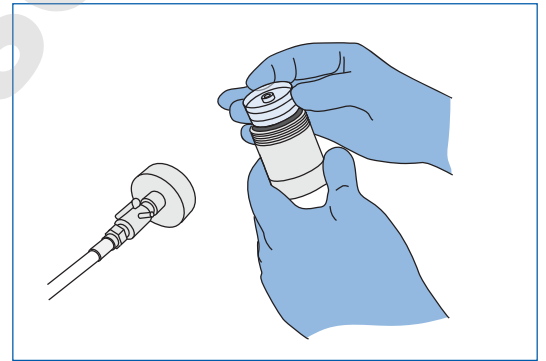

Figure 17. Installing cassette (plugs removed) into body of sampler.

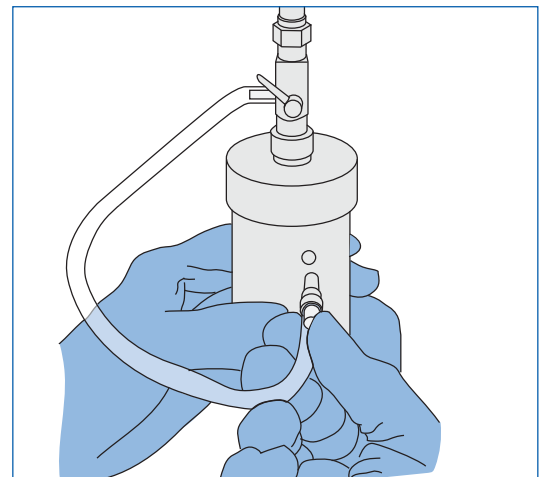

Figure 18. Connecting bypass hose from valve to bypass port of standard sampler.

7. Retract the valve collar, remove the sampler and replace the dust caps.
8. Disconnect the bypass hose from the side of the sampler, unscrew the sampler and remove the cassette (keep upright). Insert the syringe valve into the bottom of the cassette and pump it dry (Figure 19). Replace the cassette protective plugs, label it and return it to the laboratory for analysis.

For ASTM® Method D2276: Place the filter in a PetriSlide™ device and compare to ASTM® standards booklet.

When performing a colorimetric method, remove filter from cassette and place in a PetriSlide™ device. Compare the color of the filter to the color standard chart. Report color rating and volume tested.

When using matched weight filters, remove both filters from the cassette and weigh each filter. The result is the weight of the bottom filter subtracted from the top.

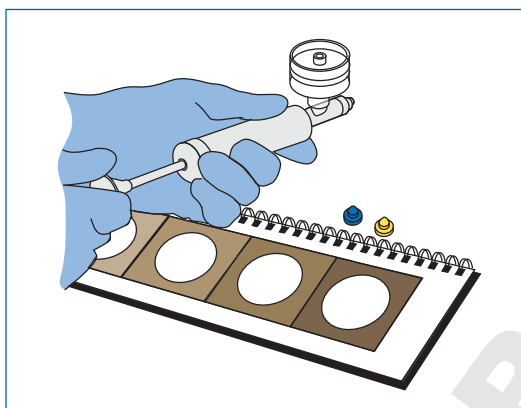

Figure 19. Removing fuel from cassette using 2-way syringe unit.

BATCH SAMPLE COLLECTION AND FILTRATION

As an alternative to in-line monitoring, you can collect liquid samples in containers and then analyze them on site or send them to the laboratory for analysis. Cleanliness of the sample collection containers is critical. Containers should be graduated and preferably slightly larger than the sample volume.

Proper Cleaning of Sample Containers

Before each use, clean the sample containers as follows:

1. Wash thoroughly with a standard laboratory cleaning solution. For critical work, check bottle cleanliness by filling and shaking with filtered solvent to dislodge particles. Then filter and analyze the solvent. If the standard cleaning procedure is not effective, you may need to clean with dilute acid or a low surface tension fluid (CFC-Free Contact Cleaner).
2. Rinse each container twice with Milli-Q® water. In this and in all other rinsing operations, a solvent filtering dispenser is especially convenient. By squeezing the bulb on the flask, as shown in Figure 20, a stream of solvent is forced from the flask, through an Merck Millipore filter, and out of the flexible dispenser tip. When you need to clean many containers at one time, the Filterjet™ solvent dispenser is especially effective and convenient (Figure 21). When connected to a pressurized solvent tank, it provides a strong jet or spray of ultraclean solvent in a continuous or trigger-controlled action.
3. Rinse the sample containers with membrane-filtered isopropyl alcohol to remove residual rinse water. A final rinse of membrane filtered CFC-Free Cleaning solvent (miscible with isopropyl alcohol) is desirable if you are going to use the containers to collect oil or hydraulic fluid samples.

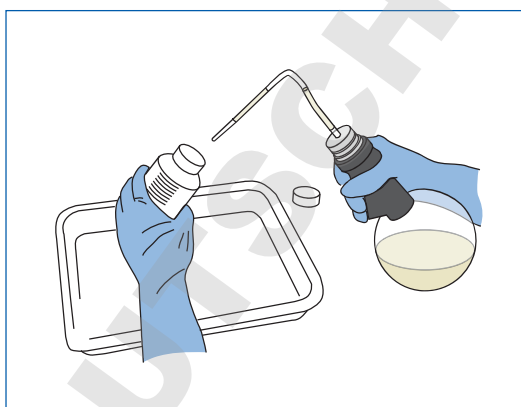

Figure 20. Flushing sample container with solvent filtering dispenser.



Figure 21. Filterjet™ solvent dispenser connected to pressure vessel and vacuum/pressure pump.

4. Place a small square of Saran® or Mylar® plastic film, rinsed with membrane-filtered solvent, over the mouth of the sample container before replacing the cap. This minimizes the danger of contaminating the container with particles from the screw cap. After closure, any residual rinse solvent evaporates in the empty sample container and creates a slight vapor pressure in it. This pressure tends to blow particles away from the mouth when the container is opened for sampling.

Location of Sampling Valves

The best sampling valves, such as ball or plug valves, provide a straight fluid path when open (Figure 22). In-line sampling valves must be made of a non-corrosive material, such as stainless steel. They should be flushed clean when first installed. If connected at a tee in the system, the valve should be oriented upward or horizontally so that any sediment in the fluid stream will not tend to settle into the tee and valve.

In dynamic systems, sampling valves should be located at points where baffles or changes in direction or pipe dimensions create turbulence. If possible, they should be installed just upstream of the most contamination-sensitive components in the system.

In static systems, such as storage tanks, the sampling valve should be located at the outlet connection. In the case of drums and similar fluid containers, the conventional stopcock or drain valve will usually suffice for sampling purposes.

Sample Collection

Dynamic systems should be operated for several minutes before taking the sample. This ensures that contaminants are evenly distributed throughout the system.

1. Open the sampling valve while the system is operating and allow sufficient liquid to flow into a waste container to flush out the valve. Never collect the sample immediately upon opening the sampling valve.
2. Remove the cap from the sample bottle and hold it in your free hand.
3. Place the bottle into the liquid stream immediately and collect the desired volume (Figure 23). Do not rinse the walls of the container in the sample fluid.
4. Remove the container from the stream and replace the plastic film and cap.
5. Turn off the sampling valve.

NOTE: Avoid wiping the sampling valve or the neck of the bottle with a cloth or paper towel since this may introduce fibers into the sample.

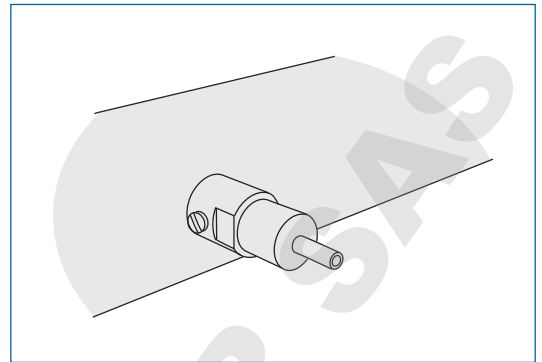

Figure 22. ESP (engineered synthetic polymer) Valve fitted in horizontal position into PVC high purity water line.

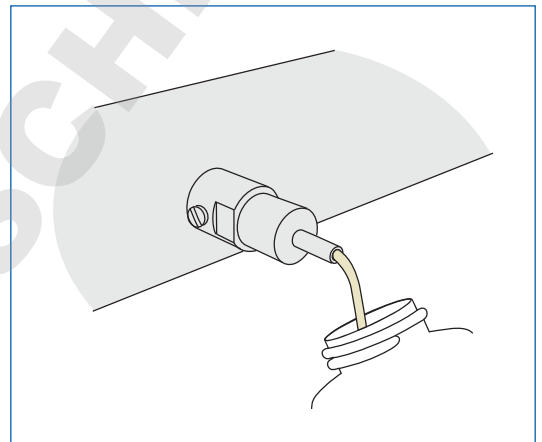

Figure 23. Collecting water sample from ESP Valve fitted into D.I. (deionized) water line.

6. Label the container.
7. Return the sample bottle to the laboratory promptly for filtration and analysis.

NOTE: If you would rather analyze your samples on-site, see the "Patch Test Kit Collection and Filtration" section later in this chapter.

Filtration Equipment Preparation

Before using the laboratory filter apparatus (Figure 24), you should carry out the following cleaning procedure:

1. Wash the filter holder in a standard laboratory cleaning solution. Rinse with hot water.
2. Rinse twice with laboratory grade water, dispensed from either a solvent filtering dispenser (Figure 25) or a Filterjet™ solvent dispenser (Figure 21).
3. Rinse with membrane-filtered isopropyl alcohol, dispensed from either a solvent filtering dispenser (Figure 26) or Filterjet™ solvent dispenser (Figure 21) to remove water and allow to dry.

For critical applications, check filter holder cleanliness by passing clean (already filtered) fluid through the filter holder and inspecting the filter for particles. If particles are visible, the cleaning procedure should be repeated or modified.



Figure 24. Laboratory Filter Apparatus assembled using the Fluid Contamination Kit (Cat Nos. XX7104711K and XX7104712).

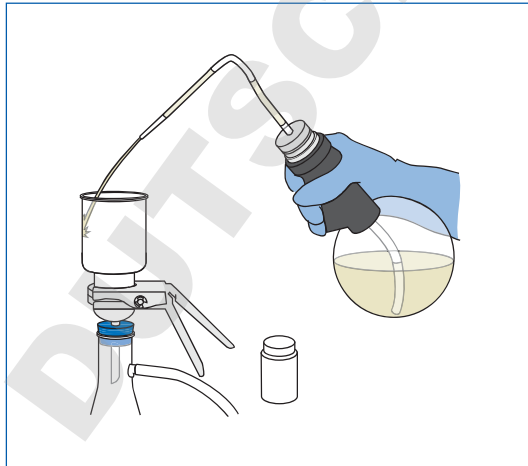

Figure 25. Flushing inside walls of glass filter funnel with solvent filtering dispenser.



Figure 26. Flushing filter with solvent filtering dispenser.

DOMINIQUE DITACCHETTI SAS

Filtration Procedure

This procedure should be carried out on a sanitary surface or under a laminar flow hood.

1. Remove the membrane disc from the packing using forceps and rinse its surface with membrane-filtered petroleum ether or a CFC-Free Cleaning Solvent (Figure 26). Place it on the filter holder base (Figure 27). When using a gridded filter, place grid-side up.
2. Attach the funnel to the base with the spring clamp.
▲ WARNING: If you are filtering petroleum ether or other flammable solvents, you must ensure that the Hydrosol™ unit (Cat. No. XX2004720) is grounded to prevent arcing from static electricity created during filtration.
3. Pour the entire contents of the sample bottle into the funnel (Figure 28).
4. Rinse the sample bottle with membrane-filtered solvent and pour into the funnel.
5. Apply vacuum to the filter flask. When filtration is almost complete, release the vacuum.
6. Use some membrane-filtered solvent to carefully rinse the funnel walls while some liquid still remains in the funnel (Figure 29). Do not direct the solvent stream onto the filter surface— it will disturb the particle distribution. Use a solvent that evaporates readily so that the filter dries quickly. You can obtain information on recommended quick-drying CFC-Free Cleaners from Merck Millipore's Technical Service.
7. Apply vacuum and pull the remainder of the fluid through the filter disc.
 - a) **For gravimetric analysis only:** While vacuum is applied, rinse the surface of the filter with a jet of filtered solvent, moving the accumulated sediment towards the center of the filter.
 - b) **For microscopic particle counting:** Do not rinse the funnel walls or the filter surface to avoid disturbing the even distribution of particles on the filter surface.
8. Release the vacuum.
9. Remove the funnel from the holder. Using forceps, immediately place the Merck Millipore filter in a clean plastic PetriSlide™ device identified with the sample number.

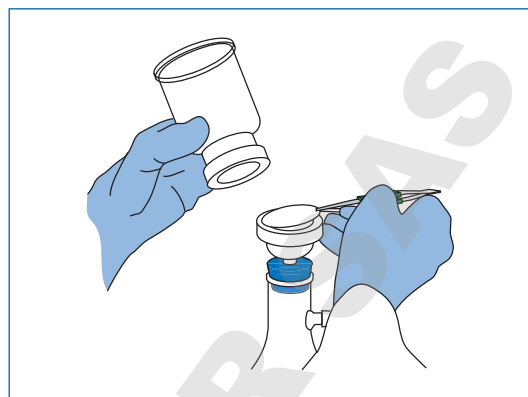

Figure 27. Placing membrane filter on base of 47 mm glass filter holder.

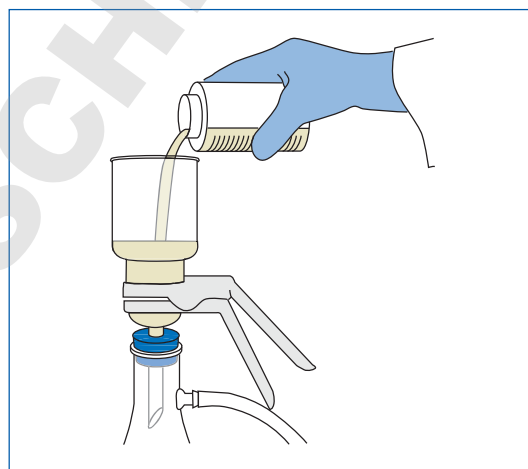

Figure 28. Pouring liquid sample into funnel of 47 mm glass filter holder.

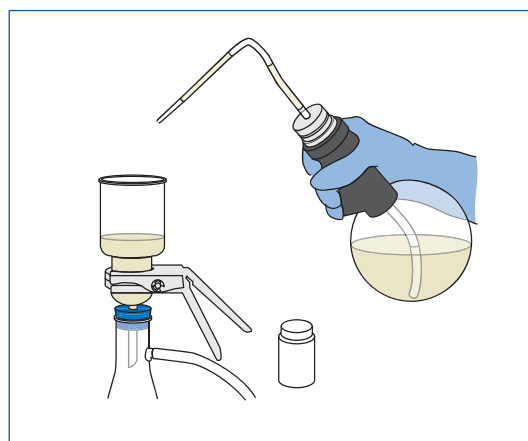

Figure 29. Rinsing the funnel walls.

On-Site Analysis Patch Test Kit Collection and Filtration

If you need to analyze your sample on site, use the Patch Test Kit, a portable filtration system that includes filter color rating and particle assessment scales that correspond to recognized standard contamination levels.

Equipment Preparation

Before using the Patch Test Kit, you should carry out the following assembly and cleaning procedure:

1. Assemble test filtration apparatus. Remove 47 mm filter holder assembly from vacuum filtration flask, if necessary using butt end of forceps to pry against flask rim at cut-out slot (Figure 30). Invert holder assembly and install in flask with funnel up, seating holder base flange evenly against flask rim.
2. Wash down inside of funnel. Close vent hole in solvent dispenser cap with your finger tip and squeeze bottle to direct jet of filtered solvent against all inner surfaces of funnel (Figure 31). Use enough solvent to carry all contaminants through filter holder screen and into flask.
3. Install test filter. Remove funnel from test filter holder by turning knurled ring to left until free, then lifting. With forceps, center a 47 mm white test filter disc on wire mesh support screen (Figure 32). Replace funnel, and retighten knurled ring to seal filter in place.
4. Attach syringe vacuum pump. The free end of the flexible tube attached to the syringe is fitted with a small nylon adapter. Insert adapter firmly into small hole on side of filter holder base (Figure 33). Tube and adapter are normally left attached to syringe for storage, but can be removed for cleaning.

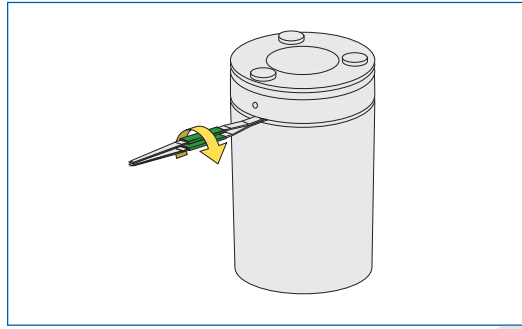

Figure 30. Remove 47 mm filter holder assembly from vacuum filtration flask.

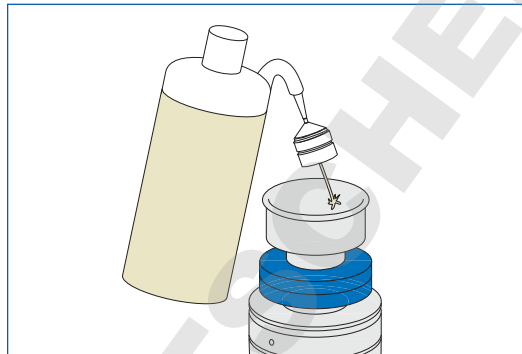

Figure 31. Wash down inside of funnel

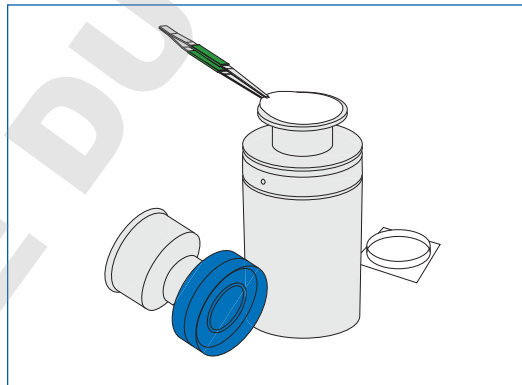

Figure 32. Center 47 mm white test filter disc on wire mesh support screen.

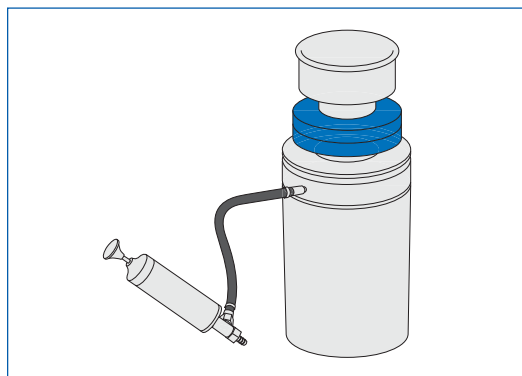

Figure 33. Insert adapter in the end of the syringe tube into hole on side of filter holder base.

Sample Collection

Using filtered solvent, rinse out the inside of the clear plastic bottle you will use to hold test fluid sample, then properly discard the used solvent (Figure 34). Fill the sample bottle to the shoulder point with fluid to be tested, and cap securely.

Filtration Procedure

1. Filter test sample. Shake sample bottle, and pour contents into funnel, pouring against funnel walls to distribute fluid evenly over filter. Then work syringe plunger to draw vacuum inside flask, until level of fluid in funnel just begins to fall, showing start of filtration (Figure 35).
2. Rinse contamination from sample bottle. Fill test sample bottle 1/3 full with filtered solvent, shake thoroughly, and pour into funnel as soon as level of fluid permits (Figure 36). Operate syringe again to sustain filtration if necessary.
3. Rinse contamination from funnel walls. When sample level in funnel drops to narrow neck of funnel, wash down inner surfaces of funnel with stream from filtered solvent dispenser (Figure 31). Do not let solvent stream directly strike test filter. Work syringe to draw all fluid through filter.
4. Check test filter against standard. Remove funnel from base, lift off test filter with forceps, place face-up in uncovered PetriSlide™ device, and let dry completely in still air. Replace PetriSlide™ cover, and compare filter appearance with standard to determine the contaminant level (Figure 37). If trichloroethane or dry cleaning fluid is used as solvent, filter must be dry before placing in the PetriSlide™ device, to avoid clouding plastic.

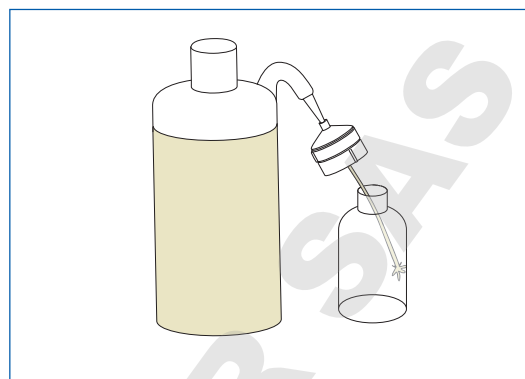

Figure 34. Rinse inside of sample collection container

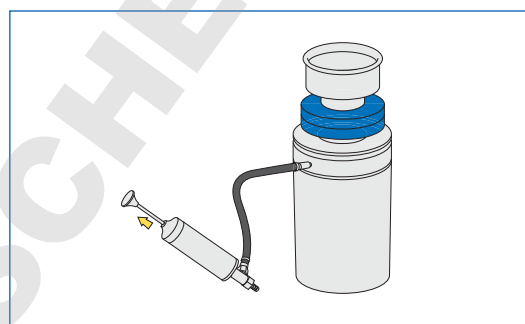

Figure 35. Work syringe plunger to draw vacuum inside flask.

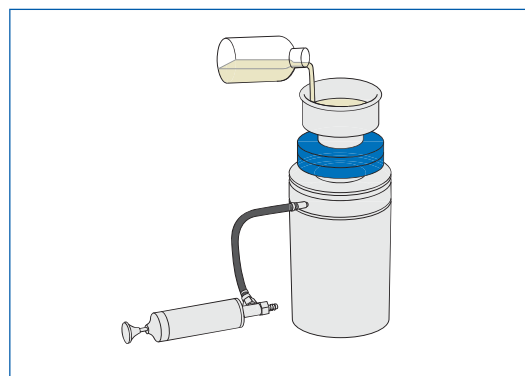

Figure 36. Rinse contaminant from sample bottle and pour into funnel.

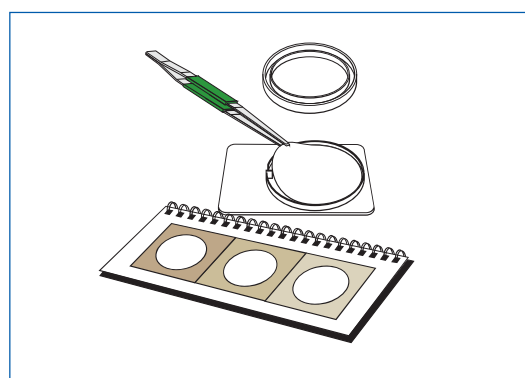

Figure 37. Check test filter against standard to determine contamination level.

COMPONENTS MONITORING

All components monitoring procedures involve rinsing the item to be sampled with particle-free solvent, then recovering the solvent and filtering it through an Merck Millipore filter for subsequent analysis.

The recovery of particles and reproducibility of the test will depend upon:

- The nature of the solvent used. CFC-Free Contact Cleaners, alcohol, and water are commonly used. Once you have chosen a solvent, avoid switching from one to another.
- The volume of solvent per unit surface area.
- The flow intensity of spray velocity.
- The intensity of any mechanical or ultrasonic agitation of the liquid in contact with the surface.

In establishing a test procedure, you must keep the following factors constant as part of the test criteria. The examples that follow are illustrative only. You may analyze the collected liquid by any of the procedures listed in the "Analytical Methods for Determination of Particle Contamination" section in Chapter I, although particle counting analyses are most often used. Once established, conduct the test procedure for a given device the same way each time to achieve maximum reproducibility.

Tubing and Hoses Sampling

- **Short Lengths:** Fill the tubing you need to test approximately 3/4 full with a membrane-filtered solvent. Cap each end and turn end over end or flex six times. Decant the solvent directly into a clean glass filter holder or into a clean sample bottle. Process sample for filtration in the laboratory.
- **Long Lengths:** Connect a source of pressurized, membrane-filtered solvent to the test tubing. Place the membrane filter immediately before the tubing to be tested. Collect the solvent from the end of the tubing in a clean sample bottle. (Use 10X the internal tubing volume as a guide to the total solvent volume. If large volumes of solvent are used, it may be necessary to take a sample from the collected solvent.) Process sample for laboratory filtration.

Small Valves and Manifolds Sampling

Connect the part by means of suitable adapters and clean hoses to a source of pressurized membrane filtered solvent. Collect the solvent at the outlet of the part in a clean sample bottle or pass it through an Merck Millipore sampler.

Large Valves and Fittings Sampling

Transport the part in a clean container protected from plant and machining debris. Remove any protective covers. Hold the component with your gloved hand (preclean the glove if necessary) over a filter holder funnel, a clean sample container or a clean tray (Figure 38). Direct a forceful stream of membrane-filtered solvent over entire component, including inner surfaces and crevices. Collect the entire volume of liquid for analysis. Use approximately 200 mL of solvent per square foot of surface area (2 L/m²). Apply at least 200 mL of flushing solvent, regardless of component size.

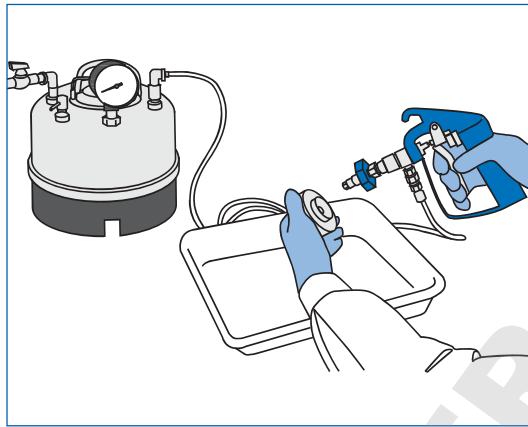

Figure 38. Flushing component with Filterjet™ solvent dispenser

IV. ANALYSIS

OPTICAL MICROSCOPE PARTICLE COUNTING

Direct particle counting on an Merck Millipore filter is a simple and rapid procedure where you either examine the filter directly with incident light or render it transparent so that you can apply transmitted light. The filter is placed directly on the movable stage of a binocular microscope with the contaminant side up. It is slowly traversed back and forth. As particles come into the field of view they are counted in several discrete size ranges.

Using the light microscope for direct counting on a filter offers a number of important advantages. You can:

- Determine the size distribution of particles.
- Detect large particles or fibers easily.
- Identify particles to locate sources of contamination.

You can vary the procedure to accomplish your specific goals. When you are only interested in very large particles ($>150\ \mu\text{m}$), you can be less careful about cleaning your equipment. If appropriate, save time by counting particles down to 50 or 100 μm rather than down to 2 or 5 μm , since such procedures are adequate in many instances.

In all particle counting procedures, adequate illumination, well-aligned optics and careful operator training are necessary.

Filter Clearing

For transmitted light microscopy, you must render the filter transparent, a procedure called "clearing the filter." Several methods are available, but you should always use mixed esters of cellulose membrane filters.

Acetone/Triacetin Method

1. Switch on the acetone vaporizer (such as that provided by Zefon, Cat. No. ZA0190).
2. Put a small volume of acetone in the syringe.
3. Cut the filter into four quarters using a rocking motion with a sharp scalpel (Figure 39).
4. Place a quarter of the membrane filter (sample side up) on a cleaned glass microscope slide (Figure 40). The other quarters are available for additional tests.
5. Place the slide on the small stand approximately 2 cm below the outlet of the vaporizer.
6. Inject 0.25 mL of acetone. The filter normally clears immediately. If it does not totally clear, repeat the acetone injection and reduce the slide to outlet distance for subsequent filters.
7. Place one to three drops of glycerol triacetate (Triacetin) on the acetone-cleared filter (Figure 41), then immediately lower a clean cover slip onto the Triacetin at an angle (Figure 42). Do not press on the cover slip. A cover slip is essential if particles below 5 μm are to be counted.
8. Heat the filter for a few minutes to accelerate the clearing process (if needed). The mounted filter is stable and will not disintegrate.

Once the filter sample has been cleared and mounted, use phase contrast microscopy. If you used a gridded filter, the grids will remain visible to aid counting and to give a focal plane of reference.

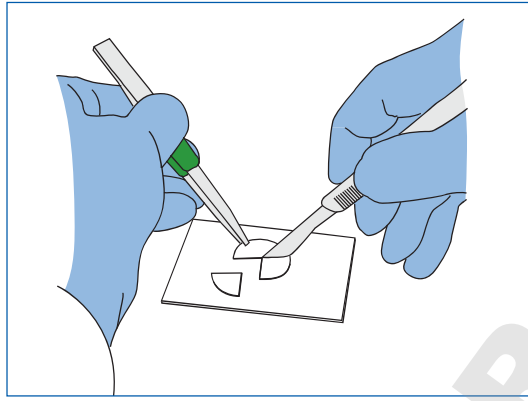

Figure 39. Cutting quarters from particle-laden 25 mm filter for subsequent clearing and examination.

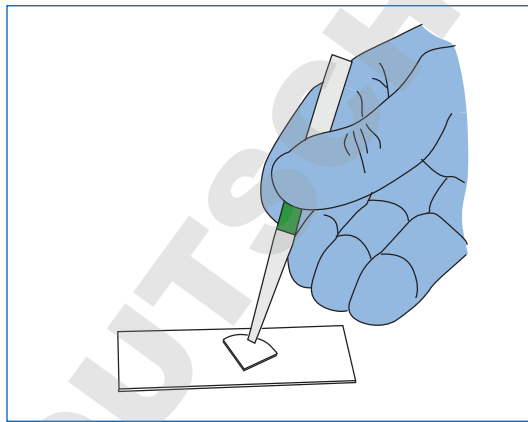

Figure 40. Placing filter section onto a cleaned 1" x 3" microscope slide.

Dimethylphthalate and Diethyloxylate Method

To prepare mounting medium:

1. Dissolve aerosol analysis filter in a 1:1 solution of dimethylphthalate and diethyloxylate (at a ratio of 0.2 g filter to 1 mL of solution). You can make up large volumes of this solution and store it out of sunlight in a stoppered bottle. Filter mounting medium as it is dispensed using a solvent-resistant syringe filter unit.
2. Place a drop of mounting medium on a freshly cleaned glass microscope slide to mount the membrane filter sample. For best results when cleaning slides, rinse with filtered CFC-Free Contact Cleaner.
3. Use a scalpel to cut a wedge-shaped piece from the filter with an arc length of about 1 cm. Carefully store the remaining filter. Avoid contamination in the event a second wedge must be cut.
4. Transfer the wedge of filter (keep sample side up) to the drop of mounting media using smooth tipped filter forceps. Cover with a cover slip. The filter becomes transparent in about 15 minutes at room temperature.

Microscope Immersion Oil Method

Using forceps, float the filter on a film of immersion oil in the cover of a plastic petri dish. Draw the filter over the rim of the cover to remove any excess oil and mount on the glass microscope slide.

Equipment

When using an Merck Millipore Fluid Contamination Analysis Kit (Figure 24) to collect samples, you will need only the microscope illuminator, stage micrometer and tally counter.

A suitable microscope for particle counting should have:

- a binocular body
- a mechanical stage
- a multiple nosepiece
- 4X, 10X and 20X objectives
- a 10X Kellner or wide-field eye piece

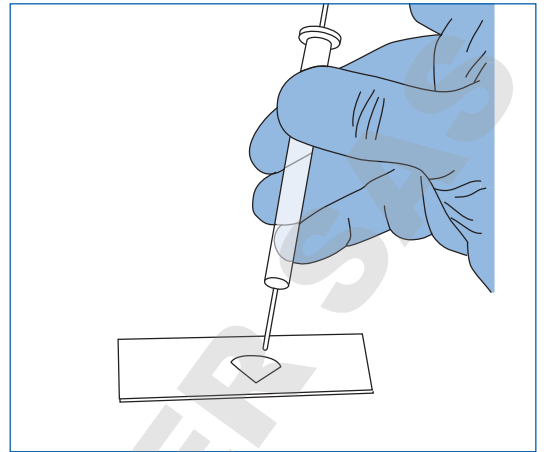

Figure 41. Adding Triacetin solution to acetone cleared filter.

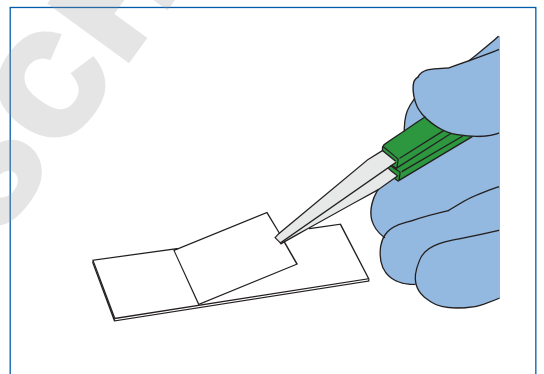

Figure 42. Cover slip placed at an angle over filter cleared using Triacetin

Measuring Eyepiece (Reticle) Calibration

Before counting and measuring particles, you must calibrate the measuring eyepiece reticle of the microscope using a stage micrometer. Calibrate the scale with each objective to be used in the counting/measuring procedure.

The stage micrometer is a glass slide with etched graduations (Figure 43). These graduations are accurately measured in millimeters as follows:

(a) From A to B = 1 mm (1000 μm); (b) From B to C = 0.1 mm (100 μm); (c) From C to D = 0.01 mm (10 μm).

1. Swing the lowest magnification objective into position.
2. Remove the eyepiece from the microscope (Figure 44) to focus the eyepiece reticle. Look through the eyepiece with one eye and focus the reticle while keeping the second eye open and focused into the distance. This procedure minimizes eye strain when particle counting. Replace the eyepiece in the microscope.
3. Place the stage micrometer onto the microscope stage. Adjust the microscope to bring the graduations of the stage micrometer into sharp focus.
4. Line up the eyepiece reticle with the stage micrometer (Figure 45).

Assuming that the example diagram represents what is seen when using a 4X objective (and 10X ocular), line up and calibrate the reticle divisions. Based upon 100 divisions of this reticle subtending 1050 μm on the stage micrometer, the calibration would be:

$$\frac{1050}{100} = 10.5 \mu\text{m per fine division}$$

The figure of 10.5 μm /fine division would remain fixed for this particular combination of microscope, 4X objective, 10X eyepiece and reticle.

5. Repeat the above tests for the other objectives to be used.
6. Make a note of these calibration factors for future use with this microscope.

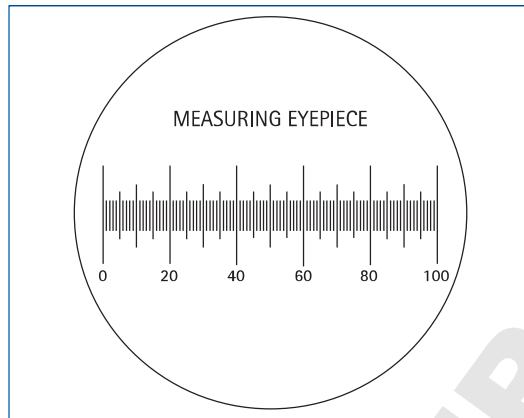

Figure 43. A standard stage micrometer.

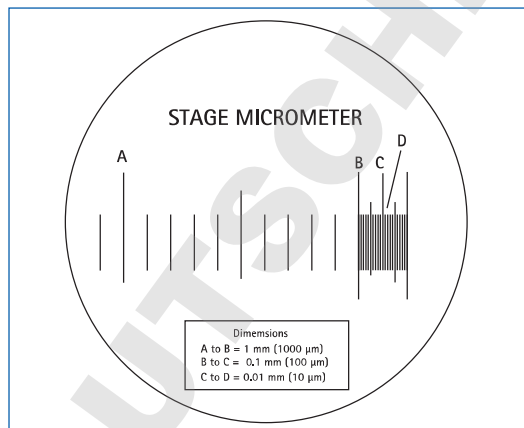

Figure 44. A standard measuring eyepiece (reticle) containing 100 linear graduations.

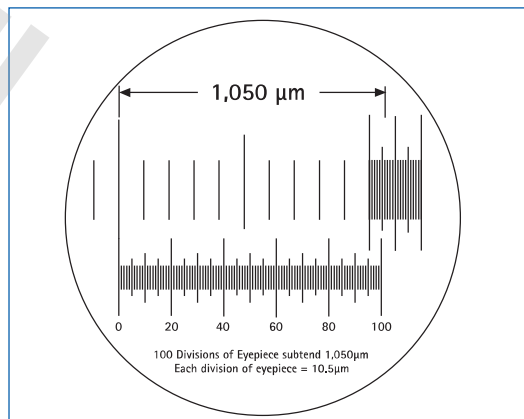

Figure 45. Based on the subdivisions of the stage micrometer (top), determine the scale of the divisions of the measuring eyepiece (bottom). This scale will remain constant at that magnification.

Particle Counting

Calibrate the eyepiece scale if this has not been done. When using transmitted light microscopy, you must first render the filter transparent. (See previous section "Filter Clearing.") This procedure results in a transparent wedge of filter mounted on a glass microscope slide. If you are using incident light microscopy, place the Merck Millipore filter on a 2" x 3" glass microscope slide (1" x 3" is adequate for 25 mm filters). You may want to grease the slide lightly to hold the filter in place. A PetriSlide™ device may be used as an alternative.

1. Mount the glass slide or PetriSlide™ device containing the filter onto the microscope stage.
2. Move the microscope stage so that the particles on the membrane appear to pass under the divisions on the measuring eyepiece (Figure 46). Count the number of particles in each designated size range found in a number of fields selected using the double diameter counting plan (Figure 47). The number of particles counted multiplied by the number of fields should be equal to or greater than 500. A field may be any designated area, but is most commonly defined by the width of a grid square on the Merck Millipore filter (3.08 mm) and the length or a portion of the length of the measuring eyepiece scale. Always measure particle size by the longest dimension. Fibers (i.e. particles larger than 100 μm with a length to width ratio greater than 5:1) are usually listed separately.
3. Count the entire filter surface when counting a relatively small number of particles at low magnification, as shown in Figure 48.

When less than the entire filter surface is counted, multiply the number of particles actually counted by the total filter area divided by the area counted. The conversion factor to use is:

$$\frac{A}{3.08 LN}$$

where:

A = Effective filtering area in mm² of the filter disc. For glass filter holders, the filtering area is 960 mm². Use 900 for field cassettes. (For other filters and holders, refer to www.merckmillipore.com).

3.08 = Width in mm of filter grid square.

L = Length in mm of unit area.

N = Number of unit areas counted.

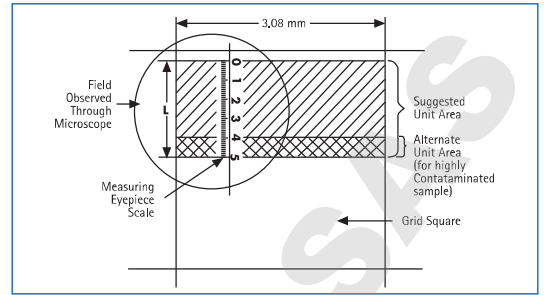

Figure 46. With an Merck Millipore filter on the microscope stage, movement of the stage makes particles appear to pass under the divisions on the measuring eyepiece.

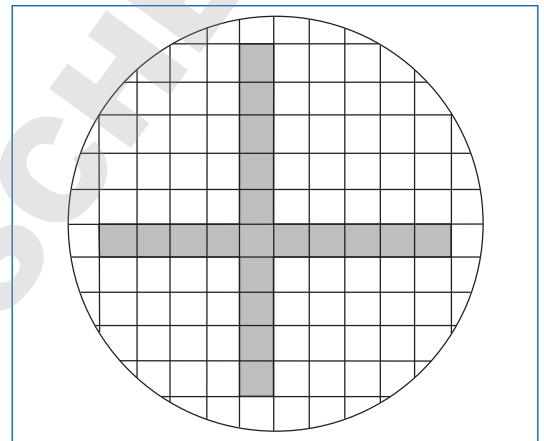

Figure 47. Double-diameter counting plan (count particles in shaded areas).

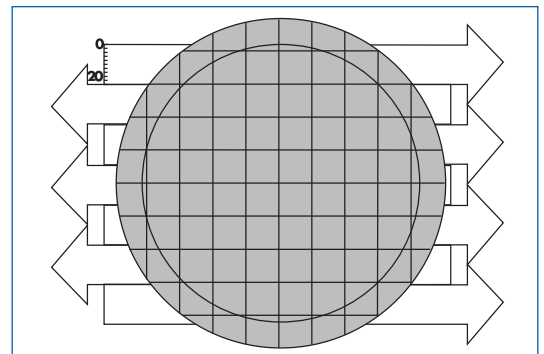

Figure 48. When scanning the entire filter at 40X magnification, the ocular micrometer scale is vertically aligned at the top left of the filtration area. The filter is scanned from left to right in the first pass, and each successive pass travels in the opposite direction.

A typical counting worksheet is shown in Figure 49. Any particle size ranges may be used. These ranges are taken from SAE International's ARP-598A method, "The Determination of Particulate Contamination in Liquids by the Particle Count Method."

When you take samples of materials such as hydraulic fluids by means of the fluid sampler, it is important that you remove all excess fluid from the filter using a vacuum syringe before the cassette is opened. (See the "On-Line Sample Collection and Filtration" section in Chapter III for details on the fluid sampler.) Flushing solvent through the cassette at this point may seriously disturb the particle distribution.

It is always good practice to prepare a blank, proceeding through all the filtering and counting operations without introducing any sample to determine the "background" count. This is an excellent measure of glassware, solvent and technique cleanliness. Blank counts should not exceed 10% of the control limits established for the fluids being tested.

Image analysis systems and electronic counters that automate microscopic particle counting are now available and many component manufacturers are implementing

them. The primary advantages of these systems are increased speed and the elimination of error due to operator fatigue. They do need careful calibration and careful filter preparation so that the particles lie in a single plane, as well as good contrast between particles and background.

Nylon Net filters are best for these automated systems because the symmetry of the nylon net and the defined pore size make it easy to determine particle size. The contrast between the white screen background and the particles allows precise calibration of the instrument before filtration. Also, the nylon material is compatible with many solvents and can be rinsed, leaving only the particles. Nylon net filters are available in many pore sizes, ranging from 5 μm to 180 μm .

NOTE: Nylon filters with a smaller pore size (0.2–1.2 μm) do not have a mesh configuration and are not appropriate for automated particle analysis.

Particle Count Data Sheet

Fluid: Hydr. B., Sample number: 23-N, Source: Test, Volume: 100 mL, Date: 4/15/15, Collected by: Peterson, Counted by: RHJ

Magnification (X)	Area per field (A)	Particle size range	Record below particles counted in each random selected field										Fields counted (B)	Total particles counted (C)	Total Area counted (D=(A) (B))	Particles in sample (C x D)	Particles per 100 mL
100	1.5 mm ²	5-15 μm	19	8	10	12	9	12	14	17	13	15	10	129	64	8256	8256
100	grid square	15-25 μm	9	7	8	8	13	6	8	5	7	8					
			12	8	11	7	8	10	5	6	8	4	20	158	5	790	790
100	grid square	25-50 μm	2	3	2	3	4	2	2	1	5	3					
			5	1	5	2	3	2	0	4	1	4	20	54	5	270	270
40	entire filter	50-100 μm											1	39	1	39	39
40	entire filter	>100 μm											1	6	1	6	6
40	entire filter	fibers											1	2	1	2	2

Figure 49. A typical counting worksheet. Any particle size range might have been used.

SCANNING ELECTRON MICROSCOPE PARTICLE COUNTING

The techniques used to count particles in a scanning electron microscope (SEM) are similar to those used to count with a light microscope. The operator places a membrane filter with the collected sample in the SEM and counts a minimum of 500 particles.

Using an energy dispersive X-ray analysis system, the operator can identify the elements present in the particles

Sample Preparation

The preferred collection filter for counting is a track-etched membrane with a pore size no larger than half the size of the smallest particles to be counted. Track-etched membranes are better because particles are easily visualized on the smooth surface. The smaller pore size ensures that the particles will be above the membrane surface, making counting more accurate.

If using a conventional, high-vacuum scanning electron microscope (SEM) operating at high accelerating voltages, you must first render the filter conductive. Gold or chromium coating is preferred for optimum image resolution but interferes with the elemental analysis of several elements. Carbon coating is suitable for elemental analysis but may yield poorly defined images at high kV. If a field emission scope is used, low kV can be used, eliminating the need for metal coating.

Calibration

Place an approved calibration grid in the SEM. Follow the manufacturer's instructions for calibrating the SEM prior to collecting the images for counting.

Particle Size and Counting

The counting technique assumes a normal distribution of particles on a collection filter. Determine the number of fields to be counted using the number of particles per field and the number of fields at a given magnification. As

the number of particles per field decreases, the number of fields counted increases and vice versa, in order to comply with the statistical needs of the normal distribution.

In practice, you adjust the number of particles per field to between 20 and 30 either by sample preparation or by decreasing the magnification (see Table 2). Under such conditions, you only need to count 20 to 30 fields in order to achieve confidence levels of 90 to 95%.

In order to count the particles on a filter, you should record at least 26 fields at a given magnification. These fields cross the disc from left to right and top to bottom. Record four additional randomly selected fields in the four quadrants created by the first fields. Place the number of particles counted along with the number of fields in the formula shown below to determine the total number of particles on the collection disc.

where:

N = number of particles counted

m = calibrated length of the micron marker in micrometers

l = actual length of micron marker on the print in cm

L = length of micrograph in cm

W = width of micrograph in cm

n = number of micrographs counted

A = filtration area of collection filter in sq. cm.

As an alternative method of particle sizing and counting, you may use an image analysis software package. The image is processed to grey levels and the particles are sized and counted by the parameters of the software or parameters set up by the operator.

Stage automation with a software interface is available on most image analysis systems that enables semi-automated counting and sizing of particles on a collection filter.

Table 2. Recommended Magnifications for Specific Particle Sizes

Particle Size (μm)	Magnification	Size of the Field (sq. cm.)	No. of Fields/sq. cm.
0.261, 0.215	10000X	1.01×10^{-6}	9.90×10^5
0.198, 0.176, 0.142	15000X	4.5×10^{-7}	2.22×10^6
0.109	20000X	2.54×10^{-7}	3.94×10^6
0.070	35000X	8.28×10^{-8}	1.21×10^7
0.038	50000X	4.06×10^{-8}	2.46×10^7

In all these cases, the magnification ensures no particle to be counted is less than 2 mm on the micrograph.

PARTICLE GRAVIMETRIC ANALYSIS

Gravimetric analysis in fluids requires less skill and equipment than microscopic particle counting. Once the specification has been established by weight, the gravimetric method provides a simple, inexpensive and highly reproducible routine control measure. For Particle Contamination in Petroleum Products (D2274) and Aviation Fuels (D2276) the ASTM® recommends a gravimetric and color rating technique. These methods are described in further detail in Chapter VI.

Gravimetric analysis involves filtering a contaminated sample through a control filter and a sample filter. In this method, you place two preweighed filters, one on top of the other, in a single filter holder then filter a sample. Particulate contaminants will be retained entirely by the top test filter. However, both filters are subjected to identical alterations in tare weight as a result of moisture loss or gain, sample adsorption or desorption, and other environmental factors. Any change in weight of the bottom ("control") filter is then applied as a correction to the weight of contaminant. The contaminant weight is determined by reweighing the test filter and subtracting its original tare weight. Results accurate to 0.1 mg are routinely attained using this method.

Filter Selection

The simplest gravimetric analyses use matched weight cassettes. Each cassette contains two Merck Millipore filters that are matched in tare weight to 0.1 mg. These cassettes are factory-assembled so that preweighing each membrane in the field before filtering the sample is unnecessary. After sampling, the weight of the contaminant is determined simply as the difference in weight between the two membranes.

Merck Millipore matched-weight cellulose filters (type AA), 0.8 μm pore size, are preweighed to within 0.1mg. These are available in 47 mm discs, 50 pairs per package, and in 37 mm matched-weight cassettes. Visit www.merckmillipore.com or call Technical Service for more details.

Sample Preparation for Gravimetric Analysis

The first three steps may be omitted when testing samples from air and other gases, water and wholly volatile solvents. All steps must be followed with viscous liquids such as paints, hydraulic oil, and turbine fuels.

1. Insert the aerosol adapter into stopper on the vacuum flask (Figure 50).
2. Remove plugs from cassette and mount the cassette, filter side up, on the aerosol adapter (Figure 51).
3. Apply vacuum and introduce membrane-filtered solvent through the top opening using a solvent dispenser (Figure 52). Release vacuum.
4. Open the cassette and transfer filters into covered glass petri dishes.
5. Loosen the lids of the glass petri dishes and place in an oven at 90 °C for 30 minutes.
6. Remove the dishes from the oven. With lids ajar, allow the filter to cool and equilibrate to ambient conditions for at least 15 minutes.

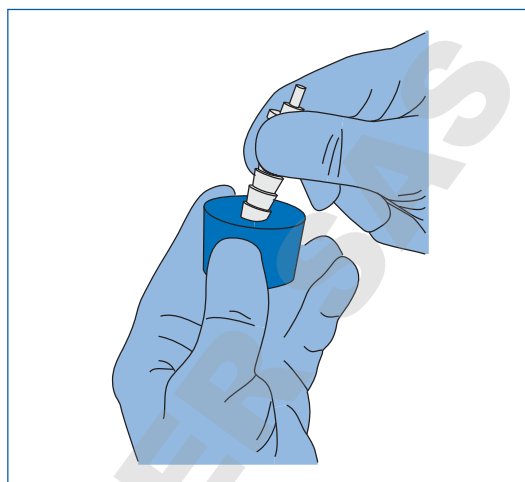

Figure 50. Placing aerosol adapter into rubber stopper, hose end down.

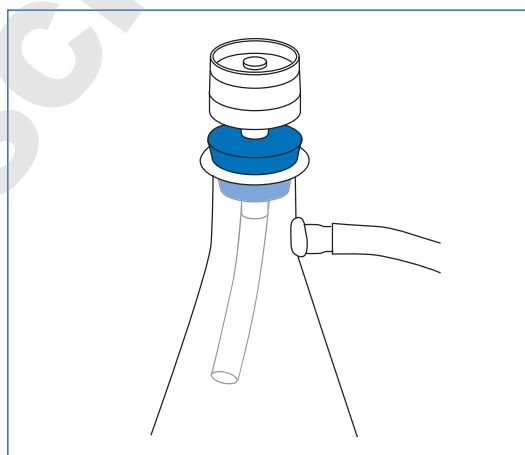

Figure 51. Cassette containing sample is fitted to Luer slip of adapter, and stopper is fitted into filter flask (inlet plug removed).

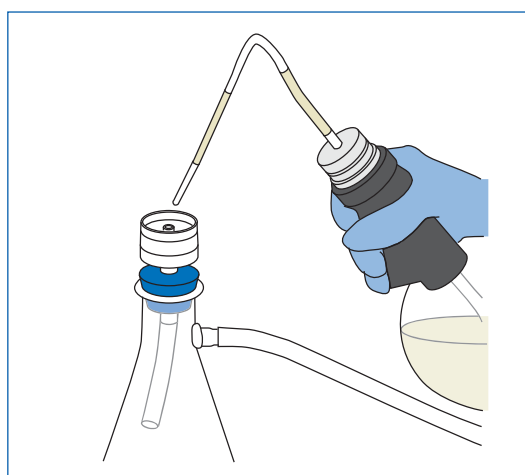

Figure 52. Introducing flushing solvent through top opening of cassette using solvent filtering dispenser.

Weighing and Calculation

The procedure for calculating the results of your gravimetric analysis samples depends on the filter method used during sample collection.

Matched-Weight Filters or Matched-Weight Cassettes

1. Reweigh both filters and record the weights.
2. Subtract the weight of the control filter from the weight of the test filter. The test filter will normally be heavier than the control filter. Negative results should be recorded as "zero" contamination.

Table 3. Typical results of matched-weight filter method

Test #	1	2	3
Final weight of test filter (mg)	49.20	51.30	50.80
Final weight of control filter (mg)	48.50	50.70	50.35
Results in: mg/ volume filtered	0.70	0.60	0.45

Control Filter Method

1. Reweigh the filters and record the final weights.
2. Subtract the initial weight from the final weight of each test filter.
3. Determine the loss or gain in tare weight of the control filter by appropriate subtraction. A weight increase greater than 0.5 mg in the control filter indicates inadequate flushing of residual test fluid from the filter. The test should be rerun.
4. Apply the control filter weight change as a correction factor to the test result.

Table 4. Typical results of control filter method

Test #	1	2	3	Control
Final weight (mg)	49.20	51.30	50.80	49.40
Initial weight (mg)	48.00	49.95	49.65	49.10
Weight (mg)	1.20	1.35	1.15	0.30
Control factor	-0.30	-0.30	-0.30	-0.30
Results in: mg/ volume filtered	0.90	1.05	0.85	

Inorganic (Noncombustible) Fraction

The inorganic fraction of the particle weight is easily determined by ashing the filter. This procedure can be used with filters made of mixed cellulose esters or other ashable material.

1. Clean and ignite a small porcelain crucible.
2. Place in a muffle furnace at 750 °C for 20 minutes.
3. Allow the crucible to cool in a desiccator and weigh it to the nearest 0.05 mg.
4. Repeat steps 2 and 3 until the crucible has constant weight.
5. Place the filter containing the contaminant residue in the crucible. Wet it with ethanol and carefully ignite the filter.
6. Cover the crucible and place it in the muffle furnace at 750 °C for 20 minutes.
7. Allow the crucible to cool in a desiccator and reweigh it. As the organic sediment will have been ignited, the final weight difference represents the inorganic particle contamination.

PARTICLE IDENTIFICATION

The key to identifying the source of particle contamination is to identify the types of particles present. Identification almost always reveals the source of the contamination.

Optical Microscopy

The most commonly applied technique in particle identification is optical microscopy. It is simple to do, inexpensive and, when done with a trained eye, identifies the largest number of contaminant particles. With experience, a microscopist can recognize a specific particle on sight. Physical characteristics such as shape, size, color and optical properties are used for identification.

Supplementary properties include particle hardness (assessed by pushing the microscope cover slip above the particle with a needle) and magnetism (detected by rotating a small magnet around the particle and seeing if it behaves like a compass needle).

Often a microscopist can identify minute particles that take major efforts with other analytical techniques. For example, skin cells, a common contaminant, are easily recognized on sight. Other methods might show the particles to be complex organic chemicals with traces of sodium and chloride but still not lead to a useful identification.

To learn more about microscopical particle identification, refer to the Particle Atlas produced by McCrone Associates*.

Other Methods

If a positive identification is not possible through optical microscopy, other methods used in particle identification include the electron microprobe or a scanning electron microscope (SEM) equipped with energy dispersive X-ray analysis (EDXRA). These methods identify the elements present in a sample. Transmission electron microscopy (TEM) may also identify very small particles by means of shape and size. In addition, TEM can give selected area electron diffraction pictures that depend on the particle's crystal structure. By this method, asbestos fibers such as chrysotile, amosite and crocidolite (blue asbestos) can be distinguished from each other and from other fibers. X-ray diffraction may also be used to identify crystal structures and hence chemical compounds. X-ray fluorescence, like EDXRA, identifies the elements present. Atomic absorption spectroscopy or other spectroscopic methods are used to determine specific metals, especially hazardous particles in air (e.g. beryllium or lead). Infrared spectroscopy is useful for identifying organic compounds but, unlike the methods above, requires a relatively large sample size. When optical microscopy is inconclusive, you can identify most common contaminants by one of these methods.

* The Particle Atlas by McCrone and Delly published by Ann Arbor Science Publishers.

** McCrone Research Institute, 3620 S. Michigan Avenue, Chicago, IL 60616.



COLORIMETRIC PATCH METHOD

A colorimetric patch test is a widely used procedure for monitoring hydraulic fluids and aviation fuels. In particular, it is used adjacent to aircraft or machinery to enable an immediate decision to be made on whether to change the fluid. Aviation fuel is the most critical because of the number of transfers the fuel will go through before it reaches its final destination. A patch test (ASTM® D3830) is performed at each point of transfer.

The typical color of a contaminant in any given system remains fairly constant. The greater the discoloration of a filter, the greater the degree of contamination. Increasing the sample volume may increase the sensitivity of the procedure. The Patch Test is generally applicable only to gross levels of contamination (Figure 53).



Figure 53. Comparing patch obtained on filter removed from fluid sampling cassette to standard colored patches (of known contaminant levels) contained in patch test booklet.

DOMINIQUE DUTSCHER SAS

V. TYPICAL CONTAMINATION LEVELS



The tables and numbers in this chapter represent typical system levels and classes of contamination as established by various organizations. Do not consider them "acceptable" levels unless they were designated as acceptable for your testing requirements. This data is helpful as a guide in establishing a reliability program if you do not have actual performance data available yet.

HYDRAULIC FLUIDS

Table 5. The Navy Standard for Hydraulic Fluids Used for Aircraft Hydraulic Systems (NAVAIR 01-1A-17):

Size Range	0	1	2	3	4	5	6
5-10 μm	2,700	4,600	9,700	24,000	32,000	87,000	128,000
10-25 μm	670	1,340	2,680	5,360	10,700	21,400	42,000
25-50 μm	93	210	380	780	1,510	3,130	6,500
50-100 μm	16	28	56	110	225	430	1,000
>100 μm	1	3	5	11	21	41	92

ISO® 4406 HYDRAULIC FLUID CLEANLINESS CODES

ISO® 4406 is a coding system designed to translate the data obtained from particle counting of hydraulic fluid samples into classes of cleanliness. It supersedes previous coding systems for hydraulic components, such as NAS 1638.

Table 6. How to use particle counts obtained from fluid samples to obtain the ISO® 4406 rating.

		Number of Particles per mL		
		More than	Up to and including	Range number (R)
		80,000	160,000	24
		40000	80000	23
		20000	40000	22
		10000	20000	21
		5000	10000	20
		2500	5000	19
		1300	2500	18
		640	1300	17
		320	640	16
		160	320	15
		80	160	14
		40	80	13
		20	40	12
		10	20	11
		5	10	10
		2.5	5	9
		1.3	2.5	8
		0.64	1.3	7
		0.32	0.64	6
		0.16	0.32	5
		0.08	0.16	4
		0.04	0.08	3
		0.02	0.04	2
		0.01	0.02	1

Example Particle Count	
Size (microns)	Count larger than size per mL
4	2136
6	463
10	161
14	63
20	29
50	6
75	2
100	1

ISO® rating = $R_4/R_6/R_{14}$
Where 4, 6 and 14 microns are particle size cutoffs.

Therefore, the ISO® rating for this example is:
18/16/13

AIRCRAFT FUELS

Activity	Total Sediment
Commercial (average)	0.2 mg/L
International Air Transport Association (IATA)	1.0 mg/USG (max)
Military Standards	4.0 mg/USG (max)

UNITED STATES MILITARY LAND-BASED HYDRAULICS

Table 7. The maximum allowable particles per 100 mL in stated particle size ranges for MILH-5606, MIL-H-27601 A, and MIL-H-81019A hydraulic fluids:

Particle Size Range	Max. Allowable Particles
5–15 µm	2500
16–25 µm	1000
26–50 µm	250
51–100 µm	25
>100 µm	None

UNITED STATES MILITARY AIRCRAFT HYDRAULICS

Table 8. MIL-PRF-5606H gives the following limits for petroleum-based hydraulic fluids in aircraft, missiles and ordnance:

Particle Size Range	Max. Allowable Particles
5–15 µm	10,000
15–25 µm	1,000
25–50 µm	150
50–100 µm	25
>100 µm	5

ROCKET PROPULSION & SERVICE FUELS*

Because of the more generous metering and pumping clearances for Missile Propellants and Service Gases, relatively high contamination levels are tolerated. The major (particulate) risk is in clogging of pump inlet screens. Fibers that will initiate clogging and silting, therefore, are specially controlled and held typically to 400 µm maximum size.

Table 9. Allowable levels of particulate contamination in fuels by U.S. Air Force (A.F.)

Fluid	A.F. Use Limits
LO1 (Liquid Oxygen)	2.5 mg/L
LN1 (Liquid Nitrogen)	2.5 mg/L
RP-1 (Rocket Engine Fuel, Grade RP-1)	1.5 mg/L
G01 (Gaseous Oxygen)	0.01 mg/L
GN1 (Gaseous Nitrogen)	0.01 mg/L
He (Helium)	0.01 mg/L

*per AFBS 61-3 (revised)

AMBIENT AIR

Table 10. The U.S. Air Force Tech. Order 00-25-203, 2 times per maximum allowable particles (≥5 µm diameter) per per cubic foot:

Condition	At Rest	Operational
Air Force Std. Clean Room	70	680
Air Force Clean Work Station	0	7

CLEANROOM GARMENTS

Table 11. ASTM® Decontamination Process Garment Classification Levels:

Class	Contamination level per square foot of fabric	Particle type
A	Less than 1000	≥5 µm particles
	Maximum 10	Fibers
B	Less than 5000	≥5 µm particles
	Maximum 25	Fibers
C	Less than 10,000	≥5 µm particles
	Maximum 50	Fibers
D	Less than 15,000	≥5 µm particles
	Maximum 125	Fibers
E	Less than 25,000	≥5 µm particles
	Maximum 175	Fibers

Obviously broken fibers and lint-bearing seams on outer surfaces of garments, wiping cloths, caps, hoods, booties, and fabrics are cause for rework or rejection. Decontamination-processed clean room fabrics are free from persistent objectionable odors.

VI. FILTER SELECTION

MF-MILLIPORE™ (MIXED CELLULOSE ESTERS) MEMBRANE FILTERS

MF-Millipore™ membrane filters are composed of a biologically inert mixture of cellulose acetate and cellulose nitrate. They are available in a variety of diameters and surface configurations to meet a wide range of application needs.

MF-Millipore™ membranes have set the standard for analytical and laboratory applications. They are recommended for a variety of analytical applications.

For gravimetric analysis by the ashing technique, incineration at 820°C or addition of HNO₃ yields a negligible ash weight of less than 0,45% of the initial filter weight.

For particle analysis by light microscopy, the standard MF-type filter has a refractive index of 1.51 and is easily rendered transparent when placed in standard immersion oil.

Chemical Compatibility

MF-Millipore™ filters are compatible with dilute acids and bases, aliphatic and aromatic hydrocarbons, and non-polar liquids. They are not compatible with ketones, esters, ether-alcohol, nitro-paraffins or strong acids and bases.

Thermal Stability

They are recommended for applications below 75°C.

Matched-weight Membranes

Type AA (0,8 µm) and HA (0,45 µm) MF-Millipore™ membrane filters, matched in pairs to within ± 0,1 mg, are available in 37 mm (AA) and 47 mm (AA and HA) diameters. Used for gravimetric analysis of particle contamination by the matched-weight filter method, these products eliminate the need to preweigh the test filter. Testing accuracy and speed are greatly improved. Matched-weight filters are also available in convenient, preloaded plastic cassette configurations (37 mm Type AA filters only).



ISOPORE™ TRACK-ETCHED (PC) MEMBRANE FILTERS

Isopore™ track-etched polycarbonate membrane filters have uniform, cylindrical pores. They are especially recommended for scanning and transmission electron microscopy, as particles are collected on the smooth surface of the membrane. Applications include particulate analysis and retention testing of microporous filters.

Surface Retention Characteristics

Isopore™ membranes have cylindrical pores that pass straight through the membrane (perpendicular to membrane surface). Their even and random distribution contributes to uniform sample distribution over the membrane surface.

All particles larger than the actual pore size are captured on the membrane surface. This absolute retention on a microscopically smooth surface makes it possible to determine the amount and type of particles in either liquids or gases.

Track-Etched Membranes for Particle Analysis

For Isopore™ membranes, no clearing is necessary for most transmitted light microscopy. For transmission electron microscopy, sample replication is straightforward. For scanning electron microscopy, a conductive coating is the only sample preparation needed.

FLUOROPORE™ AND MITEX™ (PTFE) MEMBRANE FILTERS

Fluoropore™ membrane filters are PTFE (polytetrafluoroethylene) bonded to high-density polyethylene to improve handling. Fluoropore™ membranes are also available without the polyethylene backing. These "unlaminated" membranes are supplied only in the 0.5 µm pore size, 47 mm diameter discs. They are suitable for use with strong solvents, and at high temperatures that would otherwise soften the backing material. They must be used in the standard glass filter funnels.

Mitex™ membrane filters are PTFE without a backing material and are unaffected by many liquids. These membranes are hydrophobic and can only be used with gases or non-aqueous fluids unless they are prewet with low-surface-tension fluid such as methanol.

Chemical Compatibility

Both filter types are biologically and chemically inert, and will meet extreme conditions of chemical compatibility and temperature.

Fluoropore™ membrane is compatible with strong solvents, acids, and bases. (Exceptions are aromatic hydrocarbons at temperatures in excess of 80°C).

Mitex™ membrane is compatible with organic solvents, concentrated acids, and bases within a wide thermal range.

Thermal Stability

Fluoropore™ membranes are stable up to 130°C. Mitex™ membranes are stable at temperatures in the range of +260°C to -100°C.

SILVER MEMBRANE FILTERS (PURE SILVER)

These silver membrane filters are composed solely of metallic silver. The pure silver composition makes them an ideal collection media for analysis of crystalline silica by X-ray diffraction techniques. They are also suited for analysis of organics by other instrumental analyses. Silver filters are referenced in several methods in the NIOSH Manual of Analytical Methods, for collecting airborne contaminants and sample preparation.

To ensure reproducible and reliable sampling data for any of the above applications, Merck Millipore Silver Membrane Filters are quality control tested to meet exacting standards for porosity, flow rate, thickness, as well as lot-to-lot consistency.

Merck Millipore silver membrane filters are available in a 0.45 µm pore size.

DURAPORE® (POLYVINYLIDENE FLUORIDE) MEMBRANE FILTERS

Durapore® membrane filters are designed for strength, flexibility and broad chemical compatibilities. They cannot be rendered transparent by the standard clearing procedures.

Broad Chemical Compatibilities

Durapore® membranes are compatible with many chemicals with the exception of concentrated ketones, amines, and esters. Hydrophilic Durapore® is recommended for aqueous samples. The hydrophobic version is recommended for organic samples.

Durapore® hydrophilic and hydrophobic discs are available in a variety of pore sizes, including 0.10, 0.22, 0.65 and 5.0 µm (nominal). They are also available in various diameters and surface configurations.

PVC MEMBRANE FILTERS

These filters are composed of pure medical-grade PVC and are used for monitoring airborne silica, carbon black and quartz particulates. PVC membrane filters are available in a 5.0 µm pore sizes.

GLASS FIBER FILTERS WITHOUT BINDERS

These filters are composed of borosilicate microfiber glass without binder resin and are used for environmental, gravimetric, and biochemical applications. They retain structural integrity without weight loss when ignited to 550°C after sample filtration. You can render them transparent by immersing them in benzene, ethyl alcohol, or other solvent with the same refractive index.

OTHER DEPTH FILTERS

Type AP40 Microfiber Glass Discs (for analysis only) without Binder Resin

These filters are composed of borosilicate microfiber glass and are used for determination of volatile suspended matter in contamination analysis of wastewater and industrial effluents and aerosol sampling. Since these filters contain no binders, they retain structural integrity without weight loss when ignited at 550°C after sample filtration.

Type AP10 Absorbent Pads

Also called nutrient pads, these are made of pure white cellulosic material resembling blotting paper. They are used as filter supports in Merck Millipore cassettes, and for microbiological culturing when saturated with growth medium and placed under the test filters in Petri dishes.

Type AP30 Thick Support Pads

Identical material to Type AP10, but much thicker. Used as filter supports in Merck Millipore contamination analysis cassettes, where the increased thickness is required for adequate support against high sampling pressures.

DOMINIQUE DURAPORE SAS



VII. AIR AND FLUID MONITORING APPLICATIONS GUIDE



This guide has been set up as a handy reference tool. Each compound is listed in alphabetical order with the appropriate method determined by the ASTM®, NIOSH, OSHA and ACGIH agencies. This guide summarizes the equipment and filters recommended by each agency, along with the appropriate products determined to fit these recommendations. The actual methods can be obtained, upon request, through the Internet or by contacting the appropriate agency listed below:

- NIOSH – National Institute of Occupational Safety & Health: National agency responsible for the development of sampling and analytical methods for monitoring occupational exposures to toxic substances in air and biological samples. The monitoring methods cover the collection of aerosols, gases and vapors in air with sampling equipment and samplers (filters, cassettes, cyclone holders, apparatus) followed by laboratory analysis.
- OSHA – Occupational Safety & Health Association: National agency responsible for regulating and enforcing the methods recommended by NIOSH.
- ASTM® – American Society of Testing Materials: A nonprofit organization devoted to the development of consensus standards for materials, products, systems and services. It is a US voluntary standards system which promotes US technology through standards.
- ACGIH – American Conference of Governmental Industrial Hygienists: A nonprofit organization that has a strong professional membership comprised of government (and government-related contractors) and academic industrial hygiene, safety, occupational and environmental health professionals. They participate in several of the development and regulating committees set up by OSHA and NIOSH.

Merck Millipore has been a leader in environmental monitoring filters and methods for over 40 years. We have been represented on many of the committees organized to develop the analytical procedures to monitor environmental pollutants using membrane filters and cassettes. Because of this, we understand the need for quality filters and have the technical expertise to help guide you in complying with today's environmental regulations in the following areas:

Contamination Analysis

- Air sampling
- Hydraulic fluids
- Particle monitoring
- Petroleum products
- Water and wastewater
- Air emissions
- Aerospace fluids
- Surfaces

Contamination Control

- Sample preparation
- HPLC
- Solvent clarification
- Air and gas filtration
- Surface monitoring
- UV detection
- Atomic absorption
- Gravimetric analysis

Analyte	Application	Analytical Method	Regulatory Agency	Specified Method	Approval or Last Revision Date	Recommended Membrane	Recommended Filtration Products	Appropriate Merck Millipore Products NOTE: All possible products are listed. The user should check for chemical compatibility etc., based on their specific conditions/samples/requirements
Acetaldehyde	Air	HPLC, UV detection	NIOSH	3507	1993	PTFE	37 mm 5 µm PTFE with holder for liquid filtration	MAWP037A0, XX6200004, XX5000000
Aerospace Fluids from components	Fluid	Fluid sampling for particle analysis	ASTM®	F303:08	2008	MCE, or material chemically compatible	47 mm vacuum glassware (or stainless) plus accessories. Gridded membrane, black or white, pore size no greater than 1/2 the smallest particle size of those being counted, and chemically compatible with solvents being used. Common is 0.45 µm or 0.8 µm	(XX1004700, XX1004730, or XX2004720), XX1004705, XX6602500, WP6111560 or WP6122050, XX6200006P, PD1504700 Examples are HAWG04700, HABG04700, AAWG04700, AABG04700, HVWG04700, HVLPO2500 for solvent dispenser. Potentially other pore sizes. Alternatively, kit XX7104711K (115V,USA),kit could be purchased , only adding the appropriate membrane not included in kit.
Aerospace liquid for particulate contaminants	Fluid	Particle contamination analysis using membrane filters	ASTM®	F311:08	2013	MCE, or material chemically compatible	47 mm vacuum glassware (or stainless) plus accessories. Gridded membrane, black or white, pore size no greater than 1/2 the smallest particle size of those being counted, and chemically compatible with solvents being used. Common is 0.45 µm or 0.8 µm	(XX1004700, XX1004730, or XX2004720), XX1004705, XX6602500, WP6111560, XX6200006P, PD1504700. Examples are HAWG04700, HABG04700, AAWG04700, AABG04700, HVWG04700, HVLPO2500 for solvent dispenser. Potentially other pore sizes. Alternatively, kit XX7104711K (115V,USA),kit could be purchased , only adding the appropriate membrane not included in kit.
Aldrin (octalene, old-rite, aldrosol, HHDN)	Air	Gas chromatography (GC), electrolytic conductivity detector	NIOSH	5502	1994	GF	Glass fiber filter, organic binder-free, ashless 37 mm held w/o backup pad in a 2 piece polystyrene cassette filter	M00003700, XX6200006P (3/ pk.), XX6200004, XX5000000
Alkaline dust	Air	Acid based titration	NIOSH	7401	1994	PTFE	37 mm 1.0 µm PTFE supported by a cellulose back up pad in a cassette filter holder	FALP03700 (includes AP1003700 and MAWP037A0), XX6200004, XX5000000
Aluminum	Water	Atomic absorption spectrophotometry (AAS)	ASTM®	D857:12	2012	MCE or low metals PES	Groundwater sampling capsules or portable vacuum filter holder with hand vacuum pump. Filtering in field at time of collection. Any 0.45 µm filter that will not contribute/remove metals.	GWSC04510 groundwater sampling capsules (other pk sizes available), or for smaller volumes HAWP04700 with XX1104700 and XKEM00107 hand vacuum pump, or SLLHC25NS 0.45 µm IC Millex® filter
Aluminum and compounds	Air	Atomic absorption	NIOSH	7013	1994	MCE	37 mm 0.8 µm MCE in cassette filter holder	MAWP037A0
Aluminum (elements by ICP)	Air	Inductively coupled argon plasma, atomic emission spectroscopy (ICP-AES)	NIOSH	7300	2003	MCE or PVC	37 mm 0.8 µm MCE or 37 mm 5 µm PVC	PVC503700, AP1003700, and M000037A0 (note that the PVC 5 µm 37 mm does not include the AP10 support pad, but the FALP03700 does), XX6200004, XX5000000
Aluminum	Air	Atomic absorption	OSHA	121	2002	MCE or PVC	37 mm 0.8 µm MCE	MAWP037, XX6200004, XX5000000, XX6200006P

Analyte	Application	Analytical Method	Regulatory Agency	Specified Method	Approval or Last Revision Date	Recommended Membrane	Recommended Filtration Products	Appropriate Merck Millipore Products NOTE: All possible products are listed. The user should check for chemical compatibility etc., based on their specific conditions/samples/requirements
Aqua regia (elements by ICP)	Fluid	ICP-AES	NIOSH	7301	2003	MCE	37 mm 0.8 µm MCE in cassette filter holder	MAWP037A0
Ammonia	Air	Prefiltration, air sampling, visible absorption spectrophotometry	NIOSH	6015	1994	MCE	Prefilter (to remove particulate interferences): 37 mm 0.8 µm cellulose ester membrane supported by stainless steel screen in 2 piece cassette filter holder	AAWP037A0, M000037A0, XX6200004, XX5000000
Ammonia	Air	Ion chromatography (IC)	OSHA	188	202	MCE	37 mm 0.8 µm MCE	MAWP037A0, XX6200004, XX5000000, XX6200006P
Arsenic and compounds, as As (except AsH3 and As2O3)	Air	Atomic absorption, graphite furnace	NIOSH	7900	1994	MCE	37 mm 0.8 µm MCE in cassette filter holder	MAWP037A0, XX6200004, XX5000000
Arsenic trioxide, as As	Air	Atomic absorption, graphite furnace	NIOSH	7901	1994	MCE	37 mm 0.8 µm MCE in cassette filter holder	MAWP037A0, XX6200004, XX5000000
Arsenic organo	Air	IC/hydride atomic absorption	NIOSH	5022	1994	PTFE	37 mm 1 µm PTFE polyethylene-backed membrane filter w/backup pad in cassette filter holder	FALP037 00, M0000 037A0, XX6200004, XX5000000
Arsenic	Air	Open vessel microwave digestion/ICP-MS	OSHA	1006	2005	MCE	37 mm 0.8 µm MCE in cassette filter holder	AAWP037 00, XX6200004, XX5000000, XX6200006P
Arsenic inorganic in workplace atmosphere	Air	AAS, graphite furnace	OSHA	105	1991	MCE	37 mm 0.8 µm MCE in cassette filter holder	MAWP 037 A0, XX6200004, XX5000000, XX6200006P
Asbestos particle count	Air	Transmission electron microscopy (TEM)	ASTM®	D5755:09	2014	MCE or PC	25 or 47 mm vacuum glassware plus accessories. 25 or 37 mm air monitoring plastic cassettes, pre-loaded if available.	XX1002500, XX1004700, XX1004705, PD1504700, XX620006P, XX1007615, WP6111560, GSWP02500, GSWP04700, SMWP02500, SMWP04700, GTTP02500, GTTP04700, MAWP025AC, MAWP037A0; MAWP025A0, ATTP03700 w/ M00003700, AP1003700, or ATTP02500 w/M00002500, AP1002500,.
Asbestos sample prep	Air	Transmission electron microscopy (TEM)	NIOSH	7402	1994	MCE	25 mm from 0.45 to 1.2 µm MCE, conductive cowl on cassette	MAWP025AC, XX6200004, XX5000000
Asbestos and other fibers by PCM	Air	Phase contrast microscopy	NIOSH	7400	1994	MCE	25 mm from 0.45 to 1.2 µm MCE, conductive cowl on cassette	MAWP025AC
Asbestos, chrysotile by XRD	Solid, bulk samples	X-Ray powder diffraction	NIOSH	9000	1994	PC	37 mm 1.0 µm polycarbonate filter	AG4502550, XX6200004, XX5000000
Asbestos in air	Air	Phase contrast microscopy (400X)	OSHA	160	1997	MCE	25 mm MCE white, 0.4 to 1.2 µm, conductive cowl on cassette	MAWP025AC, XX6200004, XX5000000, XX6200006P
Aspartame	Air	HPLC-UV	NIOSH	5013	1994	PTFE	37 mm 1 µm PTFE polyethylene-backed membrane filter w/backup pad in cassette filter holder	M000037A0, FALP03700, SLCR013NS, XX6200004, XX5000000
Azelaic acid	Air	GC, FID	NIOSH	5019	1994	PVC	5 µm PVC membrane in cassette filter holder	XX6200006P, XX6200004, XX5000000, PVC503700, AP1003700, M000037A0
Barium dissolved and total recoverable	Water & waste water	Atomic emission spectroscopy	ASTM®	D3986:11	2011	MCE, or low metals PES in groundwater sampling capsules, hydrophilic PTFE	Groundwater sampling capsules or portable vacuum filter holder with hand vacuum pump. Filtering in field at time of collection. Any 0.45 µm filter that will not contribute/remove metals. IC Millex® filter	GWSC04510 groundwater sampling capsules (other pk sizes available), or for smaller volumes HAWP04700 with XX1104700 and XKEM00107 hand vacuum pump, or SLLHC25NS 0.45 µm IC Millex® filter
Barium dissolved and total recoverable	Water & waste water	Atomic emission spectroscopy	ASTM®	D4382:12	2007	MCE, or low metals PES in groundwater sampling capsules, hydrophilic PTFE	Groundwater sampling capsules or portable vacuum filter holder with hand vacuum pump. Filtering in field at time of collection. Any 0.45 µm filter that will not contribute/remove metals. IC Millex® filter	GWSC04510 groundwater sampling capsules (other pk sizes available), or for smaller volumes HAWP04700 with XX1104700 and XKEM00107 hand vacuum pump, or SLLHC25NS 0.45 µm IC Millex® filter

Analyte	Application	Analytical Method	Regulatory Agency	Specified Method	Approval or Last Revision Date	Recommended Membrane	Recommended Filtration Products	Appropriate Merck Millipore Products NOTE: All possible products are listed. The user should check for chemical compatibility etc., based on their specific conditions/samples/requirements
Barium soluble ions	Water brackish, seawater and brines	Atomic absorption spectrophotometry	ASTM®	D3651:11	2011	MCE, or low metals PES in GWSC capsules, hydrophilic PTFE	Groundwater sampling capsules or portable vacuum filter holder with hand vacuum pump. Filtering in field at time of collection. Any 0.45 µm filter that will not contribute/remove metals. IC Millex® filter	GWSC04510 groundwater sampling capsules (other pk sizes available), or for smaller volumes HAWP04700 with XX1104700 and XKEM00107 hand vacuum pump, or SLLHC25NS 0.45 µm IC Millex® filter
Barium soluble compounds	Air	Atomic absorption	NIOSH	7056	1994	MCE	37 mm 0.8 MCE in cassette filter holder	MAWP037A0, XX6200004, XX5000000
Benzene soluble particulate matter	Air	Gravimetric	ASTM®	D4600-95 (2010)	2010	GF, binderless and phobic PTFE	Air monitoring cassettes with binderless glass fiber filter/ support pad, plus additional 0.45 µm PTFE syringe filter for later step in lab	APFA04700 (example, as other glass fiber binderless filters may be used. See method), AP1003700, M000037A0, plus also SLFH025NS
Benzene soluble fraction & total particulate (Asphalt fume)	Air	Gravimetric	NIOSH	5042	1998	PTFE	37 mm 2 µm PTFE	XX6200004, XX5000000
Benzidine/ 3,3-Dichloro benzidine	Air	HPLC-UV	NIOSH	5509	1994	GF	13 mm 1 µm glass fiber filter in Swinny filter holder	XX3001200
Benzoyl peroxide	Air	HPLC-UV	NIOSH	5009	1994	MCE	37 mm 0.8 µm MCE in 37 mm filter holder	MAWP037A0, XX6200004, XX5000000
Beryllium, total dissolved and total recovered particles	Water and waste water	Atomic absorption	ASTM®	D3645:08	2008	Fine textured acid washed ashless paper	Vacuum glassware plus accessories	XX1004700, XX1004705, WP6111560, PD1504700, XX6200006P
Beryllium, and compounds, as Be	Air	Atomic absorption, graphite furnace	NIOSH	7102	1994	MCE	37 mm 0.8 µm MCE in 37 mm filter holder	MAWP037A0, XX6200004, XX5000000
Boron carbide	Air	X-Ray powder diffraction	NIOSH	7506	1994	PVC	37 mm 5 µm PVC filter supported w/backup pad	PVC503700, M00003700, AP1003700, AG4502550, XX1002500 glass filter holder OR XX1002540 stainless steel filter holder. XX6200004, XX5000000
Bromine	Air	Ion chromatography, conductivity	NIOSH	6011	1994	PTFE silver	25-mm 0.45 µm silver filter with porous plastic support pad; prefilter, 0.5 µm PTFE with PTFE support, 0.5-µm or 0.4-µm polyester with porous plastic support pad.	AG4502550, FHLP02500, XX1002500 (25 mm glass filter holder); XX1002540 (stainless steel filter holder)
Bromoxy	Air	HPLC-UV	NIOSH	5010	1994	GF or PTFE	37 mm glass fiber or 2 µm PTFE membrane, with opaque cassette filter holder	FSLW03700 (3 µm porosity) supported by AP1003700. XX6200004, XX5000000
Cadmium, total dissolved particles	Water and waste water	Atomic absorption, differential pulse anodic stripping voltammetry	ASTM®	D3557:12	2012	Fine textured acid washed ashless paper	Vacuum glassware plus accessories	XX1004700, XX1004705, WP6111560, PD1504700, XX6200006P
Cadmium and compounds as Cd	Air	Atomic absorption	NIOSH	7084	1994	MCE	37 mm 0.8 µm MCE in 37 mm filter holder	MAWP037A0, XX6200004, XX5000000
Calcium (quicklime limestone, marble hydrated lime)	Air	Atomic absorption	NIOSH	7020	1994	MCE	37 mm 0.8 µm MCE in 37 mm filter holder	MAWP037A0, XX6200004, XX5000000
Carbaryl	Air	Atomic absorption	NIOSH	5006	1994	GF & PTFE	37 mm type A GF in a 37 mm cassette and PTFE	AP1003700, M000037A0, XX6200004, XX5000000
Carbon black in workplace	Air	Gravimetric	OSHA	196	2007	PVC	37 mm low-ash 5 µm PVC	PVC503700, AP1003700, and M000037A0, MAWP037A0, X6200004, XX5000000, XX6200006P
Carbon black	Air	Gravimetric	NIOSH	5000	1994	PVC	37 mm 5 µm PVC and stainless steel support screen in cassette filter holder	PVC503700, M000037A0, XX6200004, XX5000000
Chlordane	Air	Gas chromatography, electron capture detector (GC-ECD)	NIOSH	5510	1994	MCE	37 mm 0.8 µm MCE supported by a screen in a cassette holder	MAWP037A0, XX6200004, XX5000000
Chlorinated camphene	Air	Gas chromatography, electron capture detector (GC-ECD)	NIOSH	5039	1994	MCE	37 mm 0.8 µm MCE supported by a screen in a cassette holder	MAWP037A0, XX6200004, XX5000000

Analyte	Application	Analytical Method	Regulatory Agency	Specified Method	Approval or Last Revision Date	Recommended Membrane	Recommended Filtration Products	Appropriate Merck Millipore Products NOTE: All possible products are listed. The user should check for chemical compatibility etc., based on their specific conditions/samples/requirements
Chlorinated diphenyl oxide	Air	Gas chromatography, electrolytic conductivity detector	NIOSH	5025	1994	MCE	37 mm 0.8 µm MCE supported by a screen in a cassette holder	MAWP037A0, XX6200004, XX5000000
Chlorinated terphenil (60% chlorine)	Air	Gas chromatography ⁶³ Ni ECD	NIOSH	5014	1994	GF	37 mm 1 µm glass fiber supported by backup pad in polystyrene cassette	M000037A0, AP1003700, APFB03700, AP1003700, Add XX6200004, XX5000000
Chlorine/Bromine	Air	Ion chromatography, conductivity	NIOSH	6011	1994	PTFE & silver	25 mm 0.45 µm PTFE with PTFE support, silver and support	AG4502550, AP1002500, M000025A0
Chromium and compounds	Air	Atomic absorption	NIOSH	7024	1994	MCE	37 mm 0.8 µm MCE in cassette	MAWP037A0
Chromium hexavalent	Air	Visible absorption, spectrophotometry	NIOSH	7600	1994	PVC	37 mm 5 µm PVC in polyester cassette filter holder	PVC503700, AP1003700, and M000037A0, XX6200004, XX5000000
Chromium hexavalent	Air	Ion chromatography, conductivity detection	NIOSH	7604	1994	PVC	37 mm 5 µm PVC membrane in polyester cassette filter holder	PVC503700, AP1003700, and M000037A0, XX6200004, XX5000000
Chromium hexavalent	Air	Ion chromatography, with post column derivatization and UV detection	NIOSH	7605	2003	PVC	37 mm 5 µm PVC membrane in polystyrene cassette filter holder	PVC503700, AP1003700, and M000037A0, XX6200004, XX5000000
Chromium hexavalent	Air	HPLC	OSHA	215	1998	PVC	37 mm 5 µm PVC membrane filter in polystyrene cassette filter holder	PVC503700, MAWP037A0, XX6200004, XX5000000, XX6200006P
Coal tar pitch volatile (CTPV) (PAH analysis panel)	Air	Gravimetric/HPLC	OSHA	58	1986	GF	Glass fiber filter (GFP), 13 mm PTFE 5 µm	LSWP01300
Cobalt and compounds as Co	Air	Atomic absorption	NIOSH	7027	1994	MCE	37 mm 0.8 µm MCE in a cassette filter holder.	MAWP037A0, XX6200004, XX5000000
Copper (dust and fume) soluble/insoluble	Air	Atomic absorption, flame fume/dust separation IICP)	NIOSH	7029	1994	MCE	37 mm 0.8 µm MCE in a cassette filter holder. Equipment: 47 mm 0.3 µm and 5 µm w/filtration apparatus	MAWP037A0, PHWP04700, SMWP04700, XX1004730, XX6200004, XX5000000
Crotonaldehyde	Air	HPLC-UV	OSHA	81	1990	GF	2 glass fiber filters in a cassette	XX6200004, XX5000000, XX6200006P
Cyanides, aerosol and gas	Air	Ion specific electrode	NIOSH	7904	1994	PVC	37 mm 0.8 µm PVC in 2 piece cassette holder	XX6200004, XX5000000
Cyanuric acid	Air	HPLC-UV	NIOSH	5030	1994	PVC & PTFE	37 mm 5 µm PVC membrane and 25 mm 0.45 µm PTFE in polypropylene housing	PVC503700, M00003700, AP1003700, XX6200004, XX5000000
Decabromodiphenyl oxide	Fluid	HPLC-UV	NIOSH	2559	2003	Quartz fiber filter	37 mm quartz fiber filter backed in a cellulose 37 mm support, assembled in in a cassette filter holder	AQA037000, AP1003700, and M000037A0, XX6200004, XX5000000
Demeton	Air	Gas chromatography, phosphorus FPD	NIOSH	5514	1994	MCE	37 mm 2 µm MCE supported by screen in a polystyrene cassette holder	AAWP03700, M00003700, XX6200004, XX5000000
Dibutyl Phthalate	Air	Gas chromatography, FID	NIOSH	5020	1994	MCE	37 mm 0.8 µm MCE in a 2 piece cassette filter holder with backup pad.	MAWP037A0, XX6200004, XX5000000
Dibutyl phosphate	Air	Gas chromatography FPD	NIOSH	5017	1994	PTFE	37 mm 1 µm PTFE in a 2 piece polystyrene cassette filter holder	FALP03700 in M00003700, XX6200004, XX5000000
Diborane	Air	Plasma emission spectrometry	NIOSH	6006	1994	PTFE	37 mm 1 µm PTFE in plastic cassette	FALP01300 SX0001300
3,3-Dichloro-benzidine	Air	GC-MS SIM	OSHA	65	1989	GF	37 mm glass filter fiber type A/E in a 3 piece polystyrene cassette without support	M000037A0, XX6200004, XX5000000, XX6200006P
Diphenylamine/isopropylamine	Air	HPLC	OSHA	78	1989	GF	37 mm Glass fiber filter type A/E in a 3 piece cassette holder	M000037A0, XX6200004, XX5000000, XX6200006P
Dust, respirable (particulate otherwise not regulated)	Air	Gravimetric	NIOSH	0600	1998	PVC	37 mm 5 µm PVC hydrophobic membrane supported by a cassette filter holder	PVC503700, AP1003700, and M000037A0, XX6200004, XX5000000

Analyte	Application	Analytical Method	Regulatory Agency	Specified Method	Approval or Last Revision Date	Recommended Membrane	Recommended Filtration Products	Appropriate Merck Millipore Products NOTE: All possible products are listed. The user should check for chemical compatibility etc., based on their specific conditions/samples/requirements
Dust total (Particulate otherwise not regulated/total)	Air	Gravimetric	NIOSH	0500	1994	PVC	37 mm 2 - 5 µm PVC supported in a 37 mm support filter holder	PVC503700, AP1003700, and M000037A0, XX6200004, XX5000000
Dyes (benzidine- O-tolidine- O-dianisidine)	Air	HPLC-UV	NIOSH	5013	1994	PTFE	37 mm 5 µm PTFE Mitex™ filter with a backup pad in a 3 piece plastic cassette filter holder	LSWP03700, M000037A0, AP1003700, XX6200004, XX5000000
Elements by ICP	Air	Inductively coupled argon plasma, atomic emission spectroscopy (ICP-AES)	NIOSH	7300	2003	MCE or PVC	MCE 0.8 µm or 5 µm PVS	AAWP03700, PVC503700, XX6200004, XX5000000
Elemental Carbon	Air	Thermal optical analysis, flame ionization detector (FID)	NIOSH	5040	2003	Quartz fiber filter AQFA	37 mm	AQFA03700, XX6200004, XX5000000
Endrin (mendrin, nendrin, hexadrin)	Air	Gas chromatography ⁶³ Ni ECD	NIOSH	5519	1994	MCF	37 mm 0.8 µm MCF supported by a stainless steel screen in cassette filter holder	MAWP037A0, XX6200004, XX5000000
EPN, malathion and parathion	Air	Gas chromatography, flame photometric	NIOSH	5012	1994	GF	37 mm glass fiber filter type /E in a 2 piece polystyrene cassette with backup pad	MAWP037A0, M00003700, XX6200004, XX5000000
Estrogen Hormones	Air (facilities producing birth control pills)	HPLC	NIOSH	5044	1996	PTFE	37 mm 2 µm PTFE with cellulose space ring in a 2 piece cassette filter holder	M00003700, XX6200004, XX5000000
Ethylene thiourea	Air	Gas chromatography, flame photometric	NIOSH	5011	1994	PVC or MCE	37 mm 5 µm PVC filter or 0.8 µm MCE in a plastic filter cassette	PVC503700 M000037A0, AP1003700 or MAWP037A0, XX6200004, XX5000000
Ethylene thiourea	Air	HPLC-UV	OSHA	95	1992	GF	1 µm glass fiber filters in a 4 piece polystyrene cassette filter holder	APFB filter type
Fluorides gaseous and particulate	Air	Fluoride ion-selective electrode analysis	ASTM®	D4765:13	2013	MCE	37 mm 0.8µm MCE air monitoring cassette and vacuum pump	MAWP037A0, WP6111560
Fluoride particulate and gaseous	Air	Particulate filter method	ASTM® dep of Defense	D3267:12	2012	Acid treated, medium retentive prefilter	47 mm in-line filter holder and vacuum/pressure pump	XX4304700, XX4404700, WP6111560
Fluorides aerosols and gas	Air	Ion specific electrode (ISE)	NIOSH	7902	1994	MCE	37 mm 0.8 µm MCE with nucleopore and cellulose pad in a 2 piece cassette filter holder	M000037A0, AAWP03700 AP1003700 untreated pad. XX6200004, XX5000000
Fluoride in air / wipe	Air	Ion specific electrode (ISE)	OSHA	110	1991	MCE	37 mm 0.8 µm MCE in cassette filter holder	MAWP 037 A0, XX6200004, XX5000000, XX6200006P
Formaldehyde on dust (textile or wood)	Air	HPLC-UV	NIOSH	5700	1994	PVC	25 mm 5 µm PVC	PVC502500, XX6200004, XX5000000
Formaldehyde	Air	Visible absorption, spectrophotometry	NIOSH	3500	1994	PTFE	37 mm 1-3 µm PTFE	FALP03700 or FSLW03700, M000037A0, XX6200004, XX5000000
Formic acid	Air	Ion chromatography, conductivity	NIOSH	2011	1994	PTFE	25 mm 5.0 µm PTFE prefilter with porous plastic support	LSWP02500
Fuel contamination filterable and adherent insolubles	Fluid (petroleum products)	Gravimetric	ASTM®	D2274:14	2014	MCE, one step needs triton free	Vacuum glassware plus accessories, 0.8 µm, 47 mm, matched weight MCE filters	XX1004700, XX1004705, WP6111560, PD1504700, XX6200006P, AAWP0470M
Fuel, Particulate Contamination	Fluid (petroleum products)	Gravimetric and colorimetric	ASTM®	D2276:06	2014	MCE	Lab method: 0.8 µm MCE matched weight 37 mm fluid monitors with vacuum flask and accessories. Field Method: 0.8 µm MCE 37 mm fluid monitors and fluid sampling kit, color standards	Lab method (gravimetric): MAWP037PM, XX1004705, XX2004718, WP6111560, XX6602500, HAWP02500, PD1504700, XX6200006P, Field method (colorimetric): XX6403730, ASTM03701, MAWP037P0
Hydrogen sulfide	Air	HPLC-UV	NIOSH	6013	1994	PTFE	25 mm 0.45 µm PTFE in 25 mm cassette	M000025A0, AP1002500, FHLPO2500, XX6200004, XX5000000

Analyte	Application	Analytical Method	Regulatory Agency	Specified Method	Approval or Last Revision Date	Recommended Membrane	Recommended Filtration Products	Appropriate Merck Millipore Products NOTE: All possible products are listed. The user should check for chemical compatibility etc., based on their specific conditions/samples/requirements
Hydroquinone	Air	HPLC-UV	NIOSH	5004	1994	MCE	37 mm 0.8 µm MCE and a cellulose backup	MAWP037A0
Inorganic acids	Air	Ion Chromatography	NIOSH	7903	1994	PVC	37 mm 5 µm PVC in a polystyrene cassette filter holder	PVC503700, AP1003700, and M000037A0, XX6200004, XX5000000
Ion	Water	Atomic absorption spectrophotometry	ASTM®	D1068:10	2010	MCE, or low metals PES in GWSC capsules, hydrophilic PTFE, other: fine textured acid washed ashless paper	Any 0.45 µm filter that will not contribute/remove metals. Groundwater sampling capsules or portable vacuum filter holder with hand vacuum pump. Filtering in field at time of collection.	GWSC04510 groundwater sampling capsules (other pk sizes available), or for smaller volumes HAWP04700 with XX1104700 and XKEM00107 hand vacuum pump, or SLLHC25NS 0.45 µm IC Millex® filter
Isophorone diisocyanate (IPDI)	Air	HPLC	OSHA	42	1989	GF	Glass fiber filter, coated with pyridyl piperazine in a 2 piece polystyrene cassette filter holder	M00003700, Add XX6200004, XX5000000, XX6200006P
Kepon	Air	Gas chromatography, ECD	NIOSH	5508	1994	MCE	37 mm 0.8 µm MCE in a filter holder	MAWP037A0, XX6200004, XX5000000
Lead total and dissolved particles	Water and waste water	Atomic absorption differential pulse anodic stripping voltammetry	ASTM®	D3559:08	2008	MCE, or low metals PES in GWSC capsules, hydrophilic PTFE, other: fine textured acid washed ashless paper	Any 0.45 µm filter that will not contribute/remove metals. Groundwater sampling capsules or portable vacuum filter holder with hand vacuum pump. Filtering in field at time of collection. IC Millex® filter	GWSC04510 groundwater sampling capsules (other pk sizes available), or for smaller volumes HAWP04700 with XX1104700 and XKEM00107 hand vacuum pump, or SLLHC25NS 0.45 µm IC Millex® filter
Lead by flame AAS	Air	Atomic absorption spectrophotometry	NIOSH	7082	1994	MCE	37 mm 0.8 µm MCE in a cassette filter holder	MAWP037A0, XX6200004, XX5000000
Lead by GFFAS	Air	X-Ray powder diffraction	NIOSH	7105	1994	MCE	37 mm 0.8 µm MCE in a 2 piece cassette filter holder	MAWP037A0, Add XX6200004, XX5000000
Lead sulfite (galena mineral)	Air	X-Ray powder diffraction	NIOSH	7505	1994	PVC, silver	37 mm 5 µm PVC filter with a backup pad in a 2 piece 37 mm cassette, 25 mm 0.45 µm silver membrane	PVC503700, AP1003700, and M000037A0 and AG4502550, XX6200004, XX5000000
Lead by ultrasonic extraction/ASV	Air	Portable anodic stripping voltammetry	NIOSH	7701	2003	MCE	37 mm 0.8 µm MCE	MAWP037A0, XX6200004, XX5000000
Lead by field portable XFR	Air	X-ray fluorescence (XRF), portable L-shell excitation	NIOSH	7702	1998	MCE	37 mm 0.8 µm MCE	MAWP037A0, Add XX6200004, XX5000000
Lindane	Air	Gas chromatography electrolytic conductivity detector	NIOSH	5502	1994	GF binder free	37 mm glass fiber filter binder free with a backup pad in a 2 piece polystyrene cassette filter holder	AP4003705, AP1003700, M00003700, XX6200004, XX5000000
Mercaptans: methyl-, ethyl-, n-butyl-	Air	GC, FPD sulfur mode	NIOSH	2542, Issue 1	1994	GF	37 mm glass fiber w/acrylic binder in 5% (w/v) aqueous solution of mercuric acetate, in 2-piece cassette w/o backup pad impregnated with mercuric acetate.	AP1503700, AP1003700, M00003700, XX6200004, XX5000000
Mercury	Water (fresh water, saline water, and some industrial and sewage effluents)	Cold Vapor Atomic Absorption (CV-AAS)	ASTM®	D3223:12	2012	MCE	Vacuum glassware plus accessories. 0.45 µm 47 mm MCE filters	XX1004700, XX1004705, WP6111560, HAWP04700
Mercury	Water	Cold Vapor Atomic Absorption (CV-AAS)	NIOSH	6009, Issue 2	1994		A 37 mm, cellulose ester membrane filter in a cassette preceding the sorbent may be used if particulate mercury is to be determined separately.	MAWP037A0, XX6200004, XX5000000
Mercury	Air	Cold Vapor Atomic Absorption (CV-AAS)	OSHA	145	1989	MCE	37 mm 0.8 µm MCE in cassette filter holder	MAWP 037 A0, XX6200004, XX5000000, XX6200006P

Analyte	Application	Analytical Method	Regulatory Agency	Specified Method	Approval or Last Revision Date	Recommended Membrane	Recommended Filtration Products	Appropriate Merck Millipore Products NOTE: All possible products are listed. The user should check for chemical compatibility etc., based on their specific conditions/samples/requirements
Metals	Urine	Inductively-Coupled Argon Plasma Atomic Emission Spectroscopy (ICP-AES)	NIOSH	8310, Issue 2	1994		Filtering apparatus for 50mL liquid with 47 mm 0.8 µm cellulose ester membrane	More common filtration set-up is XX1004700 plus XX1004705, WP6111560. Also XX6200004, XX5000000
Metals	Air	(ICP-AES)	NIOSH	7300, Issue 3	2003		Cellulose ester membrane filter, 0.8 µm pore size; or polyvinyl chloride membrane, 5.0 µm pore size; 37 mm diameter, in cassette filter holder.	MAWP037A0 or PVC503700, AP1003700, and M000037A0, also XX6200004, XX5000000
Metals	Air	ICP-AES	NIOSH	7303, Issue 1	2003		Cellulose ester membrane filter, 0.8 µm pore size, 37 mm diameter; in cassette filter holder.	MAWP037A0, also XX6200004, XX5000000
Metals	Air	ICP-AES	OSHA	125G	2002	MCE	Mixed cellulose ester (MCE) filters (0.8 µm pore size), cellulose backup pads, and cassettes, 37 mm diameter. Cassettes, filters (MCE) and backup pads of 25 mm diameter can also be used.	MAWP 037 A0, XX6200004, XX5000000, XX6200006P
Metal and metalloid particles specific: Pb, Cd, Fe	Air	Atomic absorption	OSHA	121	2001	MCE or PVC	37 mm 0.8 µm MCE	MAWP037A0, XX6200004, XX5000000, XX6200006P
Metal and metalloid particles from solder operation	Air	ICP-AES	OSHA	206	1991	MCE	37 mm 0.8 µm MCE in cassette filter holder	MAWP 037 A0, XX6200004, XX5000000, XX6200006P
Methamphetamine only		LC-MS SIM mode	NIOSH	9111, Issue 1	2011	PES	25 mm 0.45 µm PES	SLGP033NS
Methylene bisphenyl diisocyanate (MDI)	Air	HPLC (UV or fluorescence detection)	OSHA	47	1989	GF	A glass fiber filter coated with 1.0mg of 1-(2-pyridyl)piperazine (1-2PP)	XX6200004, XX5000000, XX6200006P
4,4'-Methylenedianiline (MDA)	Air	HPLC, UV and electrochemical	NIOSH	5029, Issue 1	1994	GF & PTFE	37 mm, acid-treated glass fiber and 0.45 µm PTFE	FHLP03700, also XX6200004, XX5000000
4,4'-Methylenedianiline (MDA)	Air	GC-MS	OSHA	57	1989		37 mm, sulfuric acid-treated glass fiber	XX6200004, XX5000000, XX6200006P
Molybdenum	Water Testing (wastewater and brines)	Cold Vapor Atomic Absorption	ASTM®	D3372-12	2012	MCE, or low metals PES in GWSC capsules, hydrophilic PTFE, other: fine textured acid washed ashless paper	Any 0.45 µm filter that will not contribute/remove metals. Groundwater sampling capsules or portable vacuum filter holder with hand vacuum pump. Filtering in field at time of collection. IC Millex® filter	GWSC04510 groundwater sampling capsules (other pk sizes available), or for smaller volumes HAWP04700 with XX1104700 and XKEM00107 hand vacuum pump, or SLLHC25NS 0.45 µm IC Millex® filter
Molybdenum	Air	Atomic absorption	OSHA	ID 121	2001	MCE or PVC	37 mm 0.8 µm MCE	MAWP037A0, XX6200004, XX5000000, XX6200006P
Naphthylamines, alpha and beta	Air	GC-FID	NIOSH	5518, Issue 2	1994	GF	High-efficiency glass fiber filter, 13 mm, followed by 100mg and 50mg beds of 20/45 mesh silica gel.	AP2013000
Nickel	Water Testing	Atomic Absorption	ASTM®	D1886-14	2014	Fine textured acid washed ashless paper	Vacuum glassware plus accessories	XX1004700, XX1004705, WP6111560, PD1504700, XX6200006P
Nickel carbonyl	Air	Atomic Absorption, graphite furnace	NIOSH	6007, Issue 2	1994		37 mm 0.8 µm cellulose ester filter and cellulose backup pad in a plastic filter holder.	MAWP 037 A0, XX6200004, XX5000000
p-Nitroaniline (4-nitrobenzenamine, p-aminonitrobenzene, p-nitrophenylamine)	Air	HPLC, UV detection	NIOSH	5033, Issue 1	1994	MCE	37 mm 0.8 µm MCE and cellulose backup pad (37 mm) in a 2-piece filter holder held together by shrinkable band.	MAWP037A0, does not include tape or shrink bands. XX6200004, XX5000000
Oil mist of white mineral oil or water-insoluble petroleum-based cutting oils; cable oil; cutting oil; engine oil; heat-treating oils; hydraulic oils; machine oil; transformer oil.	Air	IR	NIOSH	5026, Issue 2	1996	MCE, PVC, PTFE or GF	37 mm 0.8 µm MCE, 5 µm PVC, 2 µm PTFE, or glass fiber filter, with cellulose backup pad in two-piece filter cassette.	PVC503700, MAWP037A0, XX6200004, XX5000000
Organic Carbon	Air	Thermal-optical analysis (TOA); flame ionization detector (FID)	NIOSH	5040, Issue 3	2003		37 mm quartz-fiber filter in a 3-piece cassette with filter support (stainless steel screen, cellulose pad, or a second quartz filter).	AQFA03700, AP1003700, M000037A0, also XX6200004, XX5000000

Analyte	Application	Analytical Method	Regulatory Agency	Specified Method	Approval or Last Revision Date	Recommended Membrane	Recommended Filtration Products	Appropriate Merck Millipore Products NOTE: All possible products are listed. The user should check for chemical compatibility etc., based on their specific conditions/samples/requirements
Organic Compounds (as Sn)	Air	HPLC, Atomic Absorption, graphite furnace	NIOSH	5504, Issue 2	1994	GF	37 mm glass fiber filter (Gelman Type AE or equivalent) in a 2 piece polystyrene cassette w/ backup holder.	AP1003700 and M0003700, also XX6200004, XX5000000
Ozone	Air	Ion Chromatography (IC)	OSHA	214	2008	GF	Glass fiber filters (GFFs), 37 mm and two-section polystyrene cassettes, 37 mm diameter with end plugs.	MAWP037 A0, XX6200004, XX5000000, XX6200006P
Paraquat (1,1'-dimethyl-4,4'-bipyridinium dichloride)	Air	HPLC (UV detection)	NIOSH	5003, Issue 2	1994	PTFE	37 mm 1 µm PTFE filter in a two-piece filter cassette held together with tape or shrink bands.	FALP03700, also XX6200004, XX5000000
Particles	Petroleum Products	Gravimetric, colorimetric	ASTM®	D2276-06	2006	MCE	Lab method: 0.8 µm MCE matched weight 37 mm fluid monitors with vacuum flask and accessories. Field Method: 0.8 µm MCE 37 mm fluid monitors and fluid sampling kit, color standards	Lab method (gravimetric): MAWP037PM, XX1004705, XX2004718, WP6111560, XX6602500, HAWP02500, PD1504700, XX6200006P, Field method (colorimetric): XX6403730, ASTM03701, MAWP037P0
Particles, insoluble contamination (particulate and gel-like matter, organic and inorganic)	Hydraulic Fluids	Gravimetric	ASTM®	D4898-90(2010) e1	2010	Material not stated	Vacuum glassware plus accessories	XX1004700, XX1004705, WP6111560, PD1504700, XX6200006P, XX6602500. Filters 0.45 µm or 0.8 µm, all materials fine. Check chemical compatibility of type of hydraulic fluid and rinse solvents chosen.
Particles (alkaline dust)	Air	Acid-base titration	NIOSH	7401, Issue 2	1994	PTFE	37 mm 1.0 µm PTFE supported by a cellulose backup pad in a cassette filter holder.	FALP 037 00, M000037A0, XX6200004, XX5000000
Particulate matter larger than 5 µm in size	Air	Particle size/count	ASTM®	F25/ F25M-09	2009	MCE, black	47 mm SS open faced vacuum holder and air monitoring accessories	XX5004710, XX5000000, WP6111560, PD1504700, XX6200006P, XX1007615, AABG04700.
Particulates not otherwise regulated, total aerosol mass	Air	Gravimetric	NIOSH	0500, Issue 2	1994	PVC	37 mm 2 to 5 µm PVC or equivalent hydrophobic filter and supporting pad in 37 mm cassette filter holder.	PVC503700, M00003700, AP1003700, does not include tape and shrink band. XX6200004, XX5000000
Pentachlorophenol	Air	HPLC	OSHA	39	1982	GF	8 mm glass fiber filter disc and 35 mm glass fiber filter	XX6200004, XX5000000, XX6200006P
Pentane Insoluble by Membrane Filtration	Petroleum Products	Gravimetric	ASTM®	D4055-04	2004	MCE	47 mm vacuum glassware plus accessories 0.8 µm MCE filters, 47 mm and 25 mm	{XX1004700, XX1004730, or XX2004720}, XX1004705, XX6602500, WP6111560, XX6200006P, PD1504700. AAWP04700, AAWP02500. Alternatively, kit XX7104711K (115V,USA), kit could be purchased, only adding the appropriate membranes, not included in this kit.
Pyrethrum	Air	HPLC, UV detection	NIOSH	5008, Issue 2	1994	GF	37 mm glass fiber filter and cellulose backup pad in filter holder held together with tape or shrinkable band.	M000037A0, AP1003700, shrink band or tape not available. XX6200004, XX5000000
Phosphine	Air	ICP	OSHA	1003	2000	GF	37 mm filter cassettes containing a glass fiber filter and a mercuric chloride-treated filter	AP4003705, AP1003700, M000037A0, XX6200004, XX5000000, XX6200006P
Phosphoric Acid	Air	IEC	OSHA	111	Not listed	MCE	37 mm diameter polystyrene 2 or 3 piece cassette filter holders. MCE filters with 0.8 µm pore size and a 37 mm diameter, supported by cellulose backup pads.	MAWP037A0, XX6200004, XX5000000, XX6200006P

Analyte	Application	Analytical Method	Regulatory Agency	Specified Method	Approval or Last Revision Date	Recommended Membrane	Recommended Filtration Products	Appropriate Merck Millipore Products NOTE: All possible products are listed. The user should check for chemical compatibility etc., based on their specific conditions/samples/requirements
Potassium, Lithium and Sodium soluble ions	Water Testing	Atomic Absorption	ASTM®	D3561-11	2011	MCE, or low metals PES in GWSC capsules, hydrophilic PTFE	Groundwater sampling capsules or portable vacuum filter holder with hand vacuum pump. Filtering in field at time of collection. Any 0.45 µm filter that will not contribute/remove metals. IC Millex® filter	GWSC04510 groundwater sampling capsules (other pk sizes available), or for smaller volumes HAWP04700 with XX1104700 and XKEM00107 hand vacuum pump, or SLLHC25NS 0.45 µm IC Millex® filter
Polychlorobenzenes ((1) 1,2,4-trichlorobenzene (2) 1,2,4,5-tetrachlorobenzene (3) pentachlorobenzene)	Air	GC, ⁶³ Ni ECD	NIOSH	5517, Issue 2	1994	PTFE	13 mm 5 µm PTFE unlaminated in stainless steel holder, Swinny-type.	LSWP01300, XX3001200 filter holder, attached to sorbent tube (tube not available).
Polynuclear aromatic hydrocarbons	Air	HPLC, fluorescence/UV detection	NIOSH	5506, Issue 3	1998	PTFE	37 mm 3 µm PTFE-laminated membrane filter, 37 mm cellulose support pad in cassette filter holder (opaque).	FSLW03700, AP1003700, M00003700, Opaque cassettes available upon request. XX6200004, XX5000000
Polynuclear aromatic hydrocarbons	Air	GC, capillary column, FID	NIOSH	5515, Issue 2	1994	PTFE	37 mm 3 µm PTFE-laminated membrane filter, 37 mm cellulose support pad in cassette filter holder (opaque).	FSLW03700, AP1003700, M00003700, Opaque cassettes available upon request. XX6200004, XX5000000
Quartz & Cristobalite	Air	XRD (X ray diffraction)	OSHA	142	1996	PVC	5 µm pore size, 37 mm diameter PVC filter preceded by a 10 mm nylon Dorr-Oliver cyclone	PVC503700, AP1003700, M00003700, also XX6200004, XX5000000, XX6200006P
Ribavirin; 1-β-D-ribofuranosyl-1,2,4-triazole-3-carboxamide; Virazole; ICN 1229	Air	HPLC, UV detection	NIOSH	5027, Issue 2	1994	GF	37 mm 1 µm glass fiber filter with a cellulose backup pad in a 2-piece cassette.	APFB03700, AP1003700, M00003700, XX6200004, XX5000000
Rotenone	Air	HPLC, UV detection	NIOSH	5007 Issue 2	1994	PTFE	37 mm 1 µm PTFE with backup pad in two-piece cassette	FALP03700, M00003700, AP1003700, Opaque cassettes available upon request. XX6200004, XX5000000
SDI, particulate matter	Water Testing (well water, filtered water or clarified effluent samples (low turbidity waters)).	SDI (Silt Density Index)	ASTM®	D4189-07	2007	MCE	SDI Assembly (e.g. Fouling index kit) plus 0.45 µm MCE filters, with or without hydrophobic edge	HAWP04700, or for edge hydrophobic: HAEPO4700
Sediment	Crude Oil	Gravimetric	ASTM®	D4807-05	2005	Nylon	47 mm Vacuum glassware and accessories, 0.45 µm nylon filter	XX1004700, XX1004705, XX6200006P, WP6111560, HNWP02500
Silica, amorphous (diatomaceous earth)	Air	X-ray powder diffraction	NIOSH	7501, Issue 3	2003	PVC	Total dust: 37 mm 5.0 µm PVC supported with backup pad in a two piece, 37 mm cassette filter holder (preferably, conductive) held together by tape or cellulose shrink band. Respirable dust: PVC (as above) plus cyclone, 10-mm nylon or Higgins-Dewell (HD), with sampling head holder. Additional filter 25 mm 0.45 µm PVC. Filtration apparatus with side-arm vacuum flask and 25 and 37 mm filter holders.	PVC503700, AP1003700, M00003700, XX6200004, XX5000000
Silica (crystalline in coal mine dust; free crystalline silica, silicon dioxide)	Air	IR	NIOSH	7603, Issue 3	2003		37 mm 5.0 µm PVC supported with back up pad in a two-piece, 37 mm cassette filter holder (preferably, conductive) held together by tape or cellulose shrink band.	PVC503700, AP1003700, M00003700, XX6200004, XX5000000

Analyte	Application	Analytical Method	Regulatory Agency	Specified Method	Approval or Last Revision Date	Recommended Membrane	Recommended Filtration Products	Appropriate Merck Millipore Products NOTE: All possible products are listed. The user should check for chemical compatibility etc., based on their specific conditions/samples/requirements
Silica (crystalline; free crystalline silica, silicon dioxide (colorimetry))	Air	X-ray powder diffraction	NIOSH	7500, Issue 4	2003	PVC	1. 37 mm 5.0 µm PVC supported with backup pad in a two-piece, 37 mm cassette filter holder (preferably, conductive) held together by tape or cellulose shrink band. 2. 37 mm 5.0 µm PVC in 3-piece cassette with high volume pump 3L/min. 3. 25 mm 0.45 µm silver membrane	1. PVC503700, AP1003700, M00003700. 2. PVC503700, AP1003700, M000037A0, 3. AG4502550, XX6200004, XX5000000
Silica (crystalline; solid by VIS)	Air	Visible Absorption Spectrometry	NIOSH	7601, Issue 3	2003	MCE	37 mm 0.8 µm MCE or 37 mm 5.0 µm PVC supported with backup pad in a two-piece, 37 mm cassette filter holder (preferably, conductive) held together by tape or cellulose shrink band.	PVC503700, AP1003700, M00003700, M000037A0, XX6200004, XX5000000
Silica (crystalline; free crystalline silica, silicon dioxide (IR))	Air	IR	NIOSH	7602, Issue 3	2003	PVC	37 mm 5.0 µm PVC supported with backup pad in a two-piece, 37 mm cassette filter holder (preferably, conductive) held together by tape or cellulose shrink band.	PVC503700, AP1003700, M00003700, M000037A0, XX6200004, XX5000000
Sodium Azide (Gaseous/Particulate)	Air	IC-UV	OSHA	211	1992	PVC	PVC membrane filter, 37 mm, 5 µm, polystyrene cassette, 37 mm diameter, spacer support pad.	PVC503700, AP1003700, M000037A0, also XX6200004, XX5000000, XX6200006P
Solder metals	Air	ICP	OSHA	206	1991	MCE	MCE filters, 0.8 µm pore size, cellulose backup pads, and two- or three-piece cassettes, 37 mm diameter.	MAWP037A0, also XX6200004, XX5000000, XX6200006P
Solid Waste Extraction (materials leached from aqueous phase)	Solid Waste	Dry, shake, and vacuum or pressure filtration (extraction)	ASTM®	D3987-12	2012	MCE or material of choice	Various 47, 90 or 142 mm filtration products and filters, diameter and pressure or vacuum holder to be determined by the customer. Filters: 0.45 µm and 8 µm MCE filters, or material of choice, of appropriate diameter.	Filter holder options: YT30142HW with 142 mm filters, HAWP14250, SCWP14250, XX1009020 vacuum filtration set up with XX1604705, and HAWP09000, SCWP09025, XX1004700, XX1004705, with HAWP04700 and SCWP04700, WP6111560, XX6200006P
Solid waste (solution to be used to determine the constituents leached).	Water containing at least 5% solids	Sequential batch extraction, pressure filtration	ASTM®	D4793-09	2009	MCE or material of choice	Pressure holder with sample chamber and filters.	YT30142HW, HAWP14250, AAWP14250, or filters of choice, WP6111560, XX6200006P
Strychnine (strychnidin-10-one)	Air	HPLC, UV detection	NIOSH	5016, Issue 2	1994	GF et nylon	37 mm glass fiber filter in cassette filter holder. Syringe filter, polypropylene housing, 0.2 µm nylon	AP4003705, M00003700, XX6200004, XX5000000
Sulfate (soluble ions)	Water Testing (brackish water, seawater and brines)	Turbidimetric	ASTM®	D4130-08	2008	MCE or material of choice	Customer choice of 0.45 µm filter/holder.	Customer choice of 0.45 µm filter/holder. An example: IC Millex® filter, SLLHC25NS
Sulfur dioxide	Air	Bubbler collection and colorimetric detection	ASTM®	D2914-01	Re-approved in 2007	MCE or material of choice	Customer to choose: 47 mm in line filter holder with a 0.8-0.2 µm filter	Examples are XX4304700, XX4404700, AAWP04700, GSWP04700
Sulfur dioxide	Air	IC	NIOSH	6004, Issue 2	1994		Two 37 mm cassette filter holders (connected in series) containing: a. (Front cassette) 0.8 µm cellulose ester supported by a backup pad. b. (Back cassette) cellulose filter which has been saturated with fixative solution and dried 20 to 30 min at 100°C, supported by a porous plastic support pad.	XX1102503 supported by a plastic support pad (call for suggestions). XX6200004, XX5000000

Analyte	Application	Analytical Method	Regulatory Agency	Specified Method	Approval or Last Revision Date	Recommended Membrane	Recommended Filtration Products	Appropriate Merck Millipore Products NOTE: All possible products are listed. The user should check for chemical compatibility etc., based on their specific conditions/samples/requirements
Sulfur dioxide	Air	IC	OSHA	200	1992	PTFE	Filter for particulate collection, PTFE, 0.45 µm, 25 mm. Carbon-filled polypropylene cassette, 25 mm.	FHLP02500, XX6200004, XX5000000, XX6200006P
Sulfuric acid	Air	IC	OSHA	113	2010	MCE	Filter holder, 2 or 3 piece cassette, polystyrene 37 mm in diameter. MCE filter, 0.8 µm pore size, 37 mm diameter, supported by a cellulose backup pad.	MAWP037A0, also XX6200004, XX5000000, XX6200006P
Super absorbent polymer (sodium polyacrylate, Sanwet IM-3500 (sodium polyacrylate grafted with starch), Water Lock A-100 (sodium acrylate-acrylamide copolymer grafted with starch), Water Lock B-204 (potassium acrylate-acrylamide copolymer grafted with starch), Water Lock G-400 (sodium acrylate-acrylamide copolymer))	Air	ICP-AES or AAS	NIOSH	5035, Issue 1	1994	PVC	37 mm 5 µm PVC in two-piece filter cassette. Vacuum filtration apparatus, two units. 25 mm 0.45 µm cellulose ester	PVC503700, M00003700, XX10 025 00, HAWP02500, also AP1003700, XX1002505, WP6111560
Trace metals	Air	AAS	ASTM®	D4185-06	Re-approved 2011	MCE	25 or 37 mm 3 piece air monitoring cassettes with 0.8 µm MCE membrane	MAWP025A0, MAWP037A0
Thiram (bis(dimethylthiocarbamoyl) disulfide; tetramethylthiuram disulfide; tetramethylthioperoxydicarbonic diamide)	Air	HPLC, UV detection	NIOSH	5005, Issue 2	1994	PTFE	37 mm 1 µm PTFE in two-piece polystyrene cassette filter holder with backup pad, sealed with tape or a shrinkable band.	FALP03700, M00003700, AP1003700, XX6200004, XX5000000
Titanium dioxide (total dust) elemental analysis method	Air	Atomic absorption	OSHA	121	2001	MCE or PVC	37 mm 0.8 µm MCE	MAWP037A0, also XX6200004, XX5000000, XX6200006P
Tributyl phosphate (phosphoric acid, tributyl ester; tri-n-butyl phosphate; TBP; Celluphos 4)	Air	GC, FPD with a phosphorus filter	NIOSH	5034, Issue 1	1994	MCE	37 mm 0.8 µm MCE supported by cellulose backup pad in three-piece filter holder.	MAWP037 A0, XX6200004, XX5000000
Trimellitic Anhydride (anhydrotremellitic acid; 1,3-dioxo-phthalanocarboxylic acid; 1,3-dihydro-1,3-dioxo-5-isobenzofuranocarboxylic acid; 1,2,4-benzenetricarboxylic acid anhydride; 1,2,4-benzenetricarboxylic acid cyclic-1,2-anhydride)	Air	GC-FID	NIOSH	5036, Issue 1	1994	PVC	37 mm 0.8 µm PVC-copolymer filter supported by a cellulose backup pad in a three-piece plastic filter holder.	AP1003700, M000037A0, XX6200004, XX5000000
Triorthocresyl phosphate (phosphoric acid, tri-o-cresyl ester; phosphoric acid, tri-o-tolyl ester; phosphoric acid, tri(2-tolyl) ester; phosphoric acid, tris(2-methylphenyl) ester; o-cresyl phosphate; o-tolyl phosphate; tricresyl phosphate; tris(o-cresyl) phosphate; tris(o-tolyl) phosphate; tris(o-methylphenyl)phosphate; TOCP; TOTP; Phosflex 179-C)	Air	GC, FPD phosphorus mode	NIOSH	5037, Issue 1	1994	MCE	37 mm 0.8 µm MCE supported by cellulose backup pad in three-piece filter holder.	MAWP037 A0, XX6200004, XX5000000
Triphenyl phosphate (phosphoric acid triphenyl ester; TPP)	Air	GC, FPD phosphorus mode	NIOSH	5038, Issue 1	1994		37 mm 0.8 µm cellulose ester with cellulose backup pad held in a three-piece cassette filter holder supported by a cellulose backup pad.	MAWP037 A0, XX6200004, XX5000000
Tungsten (wolfram)	Air	Atomic absorption, flame	NIOSH	7074, Issue 2	1994		37 mm 0.8 µm cellulose ester in cassette filter holder.	HAWP04700, XX5 000 01 (1 to 4 L/min); individual filtering apparatus (XX1504700). XX6200004, XX5000000

Analyte	Application	Analytical Method	Regulatory Agency	Specified Method	Approval or Last Revision Date	Recommended Membrane	Recommended Filtration Products	Appropriate Merck Millipore Products NOTE: All possible products are listed. The user should check for chemical compatibility etc., based on their specific conditions/samples/requirements
Vanadium oxides (vanadic anhydride; vanadium pentoxide, vanadic oxide, vanadium sesquioxide, vanadium trioxide)	Air	X-ray powder diffraction	NIOSH	7504, Issue 2	1994	PVC	37 mm 5 µm PVC filter supported with backup pad in a two-piece, 37 mm cassette filter holder (preferably, conductive) held together by tape or cellulose shrink band. 25 mm 0.45 µm silver membrane	M00003700, PVC503700, AP1003700, Vacuum filter holder setup: XX1002500/XX1004705/XX6200004, XX5000000
Warfarin (3-(4-acetylbiphenyl)-4-hydroxycoumarin)	Air	HPLC, UV detection	NIOSH	5002, Issue 2	1994	PTFE	37 mm 1 µm PTFE and cellulose backup pad in two-piece filter holder held together with tape or shrinkable band.	FALP03700, AP1003700, M00003700, XX6200004, XX5000000
Zinc (dissolved or total recoverable)	Air	Atomic absorption	ASTM®	D1691-12	2012	MCE, or low metals PES in GWSC capsules, hydrophilic PTFE, other: fine textured acid washed ashless paper	Any 0.45 µm filter that will not contribute/remove metals. Example is IC Millex® filter, or MCE or hydrophilic PTFE in vacuum filter holder	SLLHC25NS 0.45 µm IC Millex® filter, XX1004700, XX1004705, HAWP04700, WP6111560
Zinc and compounds, as Zn	Air	Atomic absorption, flame	NIOSH	7030, Issue 2	1994		37 mm 0.8 µm cellulose ester in cassette filter holder.	MAWP037A0, XX6200004, XX5000000
Zinc oxide (china white, zinc white, zincite)	Air	X-ray powder diffraction	NIOSH	7502, Issue 2	1994	PVC	25 mm 0.8 µm PVC or PVC-acrylonitrile in three-piece filter cassette.	M000025A0, Vacuum filter holder setup: XX1002500/XX1004705/XX6200004, XX5000000

VIII. APPENDIX

AEROSOL ANALYSIS CASSETTES, 25 MM

We offer a variety of 25 mm aerosol monitoring cassettes. One is an all-conductive, carbon-filled polypropylene cassette with a 50 mm extension cowl that has a unique threaded connection to provide a secure fit. A barbed hose connection tube eliminates the need for a tubing adapter. The other 25 mm cassette is a polystyrene monitor with a 16 mm center ring and female Luer slip vacuum connection. This cassette requires a tubing adapter (Cat. No. XX6200005).

These two cassettes have:

- Pre-loaded 0.8 µm mixed cellulose esters membrane and a cellulose absorbent pad
- Fittings with internal sealing
- Increased sample concentration for improved detection and more accurate analysis
- Specifications that meet the National Institute of Occupational Safety and Health (NIOSH) Method for airborne asbestos fiber monitoring

The Merck Millipore 25 mm monitors have been designed for the collection and direct analysis of asbestos, lead, nuisance dust and other contaminants. (See the Applications Guide in Chapter VI for further details.)



The reduced surface area of the 25 mm aerosol monitor and the slightly curved extension cowl ensures increased concentration and uniformity of contaminants across the filter. This feature allows for better detection and more accurate analysis.

Merck Millipore membrane filters will retain all of impinging fibers and particles equal to or larger than the rated pore size. These are collected in a uniform plane to make microscopic examination easy. This allows optimal analytical sensitivity and convenient counting. There is no need to keep refocusing the microscope. Merck Millipore membranes also become optically clear in mounting media – a feature essential for asbestos sampling and other analyses using transmission microscopy.

Cassettes are designed for use with vacuum only.

Aerosol Analysis

25 mm Aerosol Analysis Cassettes (Figure 54) have a center section between the top and bottom parts of the case. This serves as a retaining ring to hold the filter in place when the top section is removed for "open" aerosol sampling, with the vacuum connected to the cassette outlet through a suitable flow-limiting orifice. As the aerosol enters the cassette, the cowl extension causes the contaminants to disperse and land in a uniform plane across the filter.

These 25 mm cassettes are available as a three-piece unit with a center ring or an all-conductive unit with a center-extension cowl, and are supplied preloaded with membrane or empty for use with the Merck Millipore membrane filters of your choice.

Average background particle count (ABC) is marked on each package of aerosol cassettes having filters installed.

Ordering Information

For ordering information, see the "Air and Fluid Applications Guide" section in Chapter VI visit our web site at www.merckmillipore.com.

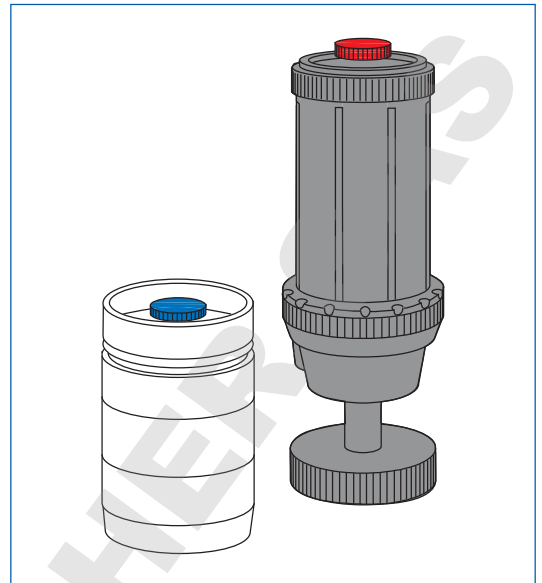

Figure 54. Aerosol analysis cassettes (25 mm)

FLUID CONTAMINATION ANALYSIS CASSETTES, 37 MM

Merck Millipore fluid contamination analysis cassettes are transparent, disposable, plastic filter holders, preassembled with type MF-Millipore™ filters in place for particulate analysis of fluid samples (Figure 55). The filter is sealed between the cassette sections with a thick cellulose pad under the filter to distribute sample flow evenly over the filter surface.

These cassettes are:

- Disposable
- Available with matched weight membrane
- Available in a 2- or 3-piece configuration

Contamination Analysis

Cassettes have average background particle count marked on each package. The special thick pad under the filter provides support at high differential pressures.

Matched-Weight Cassettes

Cassettes eliminate the need for pre-weighing test filters in gravimetric analysis. Each cassette contains two superimposed filters matched in weight to within 0.1 mg. Sample passes through both, but all contaminant is retained on the upper (test) filter. The difference in filter weights, after drying, is the weight of contaminant in the sample.

Ordering Information

For ordering information, see the "Air and Fluid Applications Guide" section in Chapter VI.

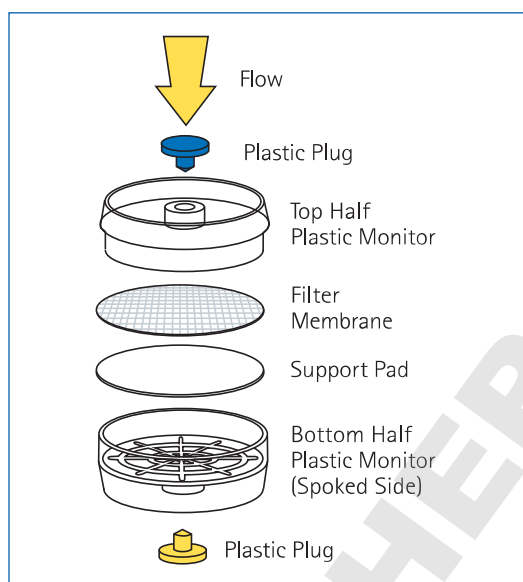

Figure 55. Fluid contamination analysis cassette, 3-piece configuration

DOMINIQUE DUTSCHER SAS

FLUID SAMPLING KIT

Merck Millipore's Fluid Sampling Kit allows sampling of liquids from pressurized systems through contamination analysis cassettes, for gravimetric or colorimetric determination of contaminant level (Figure 56).

The stainless sampler assembly, containing a cassette, is plugged into a quick-release valve installed in the system line, and a measured quantity of liquid is allowed to pass through the cassette filter. Residual liquid is then removed from the cassette by using a valved syringe as a pump.

For the gravimetric analysis, Matched-Weight Monitors (available as accessories) remove the need for pre-weighing filters before sampling.

Applications

Contamination analysis of aviation fuels, fluid storage tanks, cooling tanks

Specifications

Materials: Stainless steel, with stainless-clad PTFE hose

Connections: Quick-release valve and plug, with 1/8" NPTF thread and fluoroelastomer (vinylidene fluoride-hexafluoropropylene copolymer) seals; matching nipple on sampling hose

Pressure: 7 bars (100 psig) maximum inlet

Dimensions: Case: 368 × 235 × 124 mm (14-1/2" × 9-1/4" × 4-7/8")

Shipping Weight: 4.5 kg (9.9 lbs.)

Ordering Information

For ordering information, see the "Air and Fluid Applications Guide" section in Chapter VI or visit our web site at www.merckmillipore.com.



Figure 56. Fluid sampling kit (XX6403730)

PATCH TEST KIT

The Merck Millipore Patch Test Kit allows rapid monitoring of the degree of particulate contamination in hydrocarbon-based hydraulic fluids and lubricating oils (Figure 57). This is accomplished by observing the degree of discoloration of a 5 µm 47 mm disc filter through which a standard volume of the test liquid has been drawn by vacuum filtration.

A membrane filter color rating scale and particle assessment scale corresponding to recognized standard levels of contamination is provided for comparison in determining observed contamination levels. Test results are dependably repeatable and sensitive enough to detect any significant change in cleanliness. Free water will appear either as droplets during the test procedure, or as a stain on the test filter. Filters are included for 100 tests.



Figure 57. Patch test kit (XX6504730)

Applications

Contamination analysis of hydrocarbon-based hydraulic fluids, lubricating oils, bulk chemicals

- Patch testing hydraulic fluids
- Contamination testing of lubricants
- Purging fluid
- Particulate contamination in boiler water

Specifications

Materials: Stainless steel and aluminum filter holder assembly PVC and polyethylene sample collection and solvent dispensing bottles.







Dimensions: (case) 368 × 235 × 124 mm
(14-1/2" × 9-1/4" × 4-7/8")

Shipping Weight: 4.5 kg (9.9 lbs.)

Ordering Information

For ordering information, see the "Air and Fluid Applications Guide" section in Chapter VI visit our web site at www.merckmillipore.com.

THE FILTER HOLDER VISUAL DICTIONARY

	Glass	Stainless Steel (SS)		Plastic	
	Vacuum	Vacuum	Pressure	Vacuum	Pressure
13 mm		Epifluorescence Filter Holder  Analytical Filter Holder 	Swinny Filter Holder 		Swinnex® Holder 
25 mm	Microanalysis Filter Holder 	Analytical Filter Holder 	High Pressure Filter Holder  Solvent Filtering Dispenser  Microsyringe Filter Holder  Filterjet™ Solvent Dispenser 	1225 Sampling Manifold 	Swinnex® Holder 
47 mm	All-Glass Filter Holders  Classic Glass Filter Holder  MilliSolve™ System 	Analytical Filter Holder  Hydrosol™ Filter Holder 	SS Pressure Filter Holder  High Pressure Filter Holder 	Sterifil® System  Sterifil® 500 Filter Holder 	Swinnex® Holder  In-Line Filter Holder 
90 mm	All-Glass Filter Holder 		Standing SS Filter Holder 		
142 mm			Standing SS Filter Holder 		

FEATURED PRODUCTS FOR ENVIRONMENTAL PARTICLE MONITORING METHODS

Aerosol Analysis Monitors

Three-piece, 25 and 33 mm aerosol analysis monitors are available with 0.45 μm and 0.8 μm cellulose ester membranes. Matched weight monitors contain two filters matched in weight to within 0.1 mg, eliminating test analysis. A thin cellulose support seals the filter between monitor sections to distribute sample flow evenly over the filter surface.

Description	Catalog No.
25 mm Monitor, Type A Pre-loaded with Filter and Cellulose Pad – 0.8 μm pores	MAWP025A0
25 mm Monitor, Type B* Pre-loaded with Filter and Cellulose Pad – 0.8 μm pores	MAWP025AC
37 mm Monitor, Complete with Filter – 0.8 μm pores	MAWP037A0
37 mm Monitor, Complete with Filter – 0.45 μm pores	MHWP037A0
Matched-weight Aerosol Analysis Monitor – 0.8 μm pores	MAWP037AM

*Use Type B Monitor for airborne asbestos monitoring in accordance with NIOSH specifications.

Monitor Components	Catalog No.
Empty 37 mm Monitor Cassette with Rings and Plugs	M000037A0
Empty Monitor Case without Ring	M00003700



FILTERS FOR AMBIENT AIR MONITORING

Particulates and contaminants in the air affect human capital, the most precious natural resource. Recognizing the need to protect this resource, industries, governments and regulatory agencies around the world monitor ambient air. Merck Millipore filters are used in these ambient air monitoring methods. The quality of ambient air is typically reported as the Air Quality Index (AQI). In general, AQI takes into account levels of multiple pollutants:

- SO₂
- CO
- NO_x
- O₃
- PM10 (particulate matter $\geq 10 \mu\text{m}$)
- PM2.5 (particulate matter $\geq 2 \mu\text{m}$)
- Pb

Ordering Information for Ambient Air Monitoring Solutions

Filter	Pore Size (μm)	Qty/Pk	Diameter	Catalog No.	Compatible with methods for monitoring:
2 μm PTFE Membrane Discs for PM2.5 Monitoring (PTFE with ring)	2.0	50	47 mm	PM2547050	PM2.5
Mitex™ PTFE Membrane Filters	5.0	100	47 mm	LSWP04700	SO ₂ NO _x O ₃ CO
Glass Fiber Disc Filters (Type AP20)	2.0	100	47 mm	AP2004700	PM2.5 (EU, China)
Glass Fiber Filter Roll	2.0	1 Roll	Roll	Available upon request	PM2.5 (EU, China)
Quartz Fiber Disc Filters (Type AQFA)	N/A	100	47 mm	AQFA04700	PM2.5 (EU, China) PM10 Heavy metals
Quartz Fiber Filter Sheet (8"x10" sheet)	N/A	50	8 x 10 in.	AQFA8X105	PM2.5 (EU, China) PM10 Heavy metals
Fluoropore™ Disc Filters for Radiation Monitoring	3.0	100	25 mm	FSLW02500	Alpha particles
	3.0	100	47 mm	FSLW04700	Alpha particles
	3.0	25	90 mm	FSLW09025	Alpha particles
	5.0	100	47 mm	FMLB04700	Alpha particles

PARTICLE COUNTING SOLUTIONS FOR CONTROLLED ENVIRONMENTS

Particle counting is a critical component of clean room monitoring programs. Particle counter data are needed to detect contaminants in the air and to determine the cleanliness of air in controlled environments, such as those found in the pharmaceutical or sensitive food industries, which have to comply with ISO 14644, GMP and FS209E.

Our APC instruments meet JIS B 9921:1997 and ISO 21501 standards for performance, counting efficiency, and calibration. They are available in either stainless steel or plastic with stainless steel components. The APC SmartTouch and the APC ErgoTouch Pro 2 are ideally suited for disinfection and fulfill the most stringent hygiene standards.

Award-winning safety:

APC SmartTouch products (airborne particle counters)

Secure and reliable:

- Visual representation of sampling locations: minimizes risk of human errors.
- Ideally suited for disinfection: easy to clean.
- Equipped with high-capacity batteries: allows for continuous sampling.
- Follows strict hygiene standards.

Convenient:

- Large color touch screen with familiar icons and intuitive menu: easy to use.
- All required actions start from main menu: increases operating efficiency and saves time.

Flexible:

- Complete system with many accessories: no need to invest in multiple instruments, reducing costs of associated routine calibration.
- Designed for dual flow rates: significantly reduces clean room certification and monitoring costs.



Transportable safety:

APC ErgoTouch Pro 2 (handheld airborne particle counters)

Secure and reliable:

- All the functionalities of portable airborne particle counter, 6 channels: high performance on small scale.
- Meets JIS standards.

Convenient:

- Lightweight device: practical use.
- State-of-the-art design, large color touch screen: intuitive, easy handling.

Flexible:

- Low investment: for validation of ISO 7, 8 and GMP Gr. C, D.
- Compressed gas adaptor: available for high pressure.
- Wide range of accessories.

Learn more about particle monitoring in clean environments:

www.merckmillipore.com/environmental-monitoring

DOMINIQUE DUTSCHER SAS





www.merckmillipore.com/

Merck Millipore, the M mark, Durapore, Swinnox, Sterifil and Milli-Q are registered trademarks and MF-Millipore, Isopore, MilliSolve, Hydrosol, Mitex, Fluoropore, PetriSlide, Filterjet are trademarks of Merck KGaA, Darmstadt, Germany. All other trademarks are the property of their third party owners.

Lit No. TP5354ENEU 03/16 BS GEN-15-11936-EX

©2016 EMD Millipore Corporation, Billerica, MA, USA. All rights reserved.

To Place an Order or Receive Technical Assistance

In Europe, please call Customer Service:

France: 0825 045 645

Germany: 069 86798021

Italy: 848 845 645

Spain: 901 516 645 Option 1

Switzerland: 0848 645 645

United Kingdom: 0870 900 4645

For other countries across Europe, please call:

+44 (0) 115 943 0840 Or visit: www.merckmillipore.com/offices

For Technical Service, please visit: www.merckmillipore.com/techservice