

Register your instrument!  
[www.eppendorf.com/myeppendorf](http://www.eppendorf.com/myeppendorf)



# Mastercycler® nexus

Operating Manual

Copyright© 2021 Eppendorf SE, Germany.

All rights reserved, including graphics and images. No part of this publication may be reproduced without the prior permission of the copyright owner.

Eppendorf® and the Eppendorf Brand Design are registered trademarks of Eppendorf SE, Germany.

Adobe® and Reader® are registered trademarks of Adobe Systems Incorporated, United States.

Mastercycler®, flexlid® and SteadySlope® are registered trademarks of Eppendorf SE, Germany.

Registered trademarks and protected trademarks are not marked in all cases with ® or ™ in this manual.

U.S. Patents are listed on [www.eppendorf.com/ip](http://www.eppendorf.com/ip).

#### **Notice**

The software of the Mastercycler nexus contains open source software. License information is available as PDF documents via the Eppendorf node. To export the license documents, connect a memory device, select the Eppendorf node in the navigation tree and press the softkey License.

## Table of contents

<b>1</b>	<b>Operating instructions</b>	<b>7</b>
1.1	Using this manual	7
1.2	Danger symbols and danger levels	7
1.2.1	Danger symbols	7
1.2.2	Danger levels	7
1.3	Symbols used	8
1.4	Abbreviations used	8
1.5	Glossary	9
<b>2</b>	<b>Safety</b>	<b>11</b>
2.1	Intended use	11
2.2	User profile	11
2.3	Warnings for intended use	11
2.4	Danger symbols on the device	13
<b>3</b>	<b>Product description</b>	<b>15</b>
3.1	Product overview	15
3.1.1	Master variants	15
3.1.2	Master variants with 64+32-well thermoblocks	16
3.1.3	ECO variants	17
3.1.4	Terminal block	18
3.1.5	Control panel	19
3.1.6	Number pad	20
3.1.7	Status lamp	20
3.2	Delivery package	20
3.3	Features	21
3.3.1	Features of the Mastercycler nexus	22
3.3.2	Control panel and ports	22
3.3.3	Consumables	23
3.3.4	Networking	24
3.3.5	Service	24
<b>4</b>	<b>Installation</b>	<b>25</b>
4.1	Selecting the location	25
4.2	Installing the device	26
4.2.1	Connecting the device to the mains/power line	26
4.2.2	Attaching devices to each other	27
4.2.3	Separating devices	28
4.2.4	Using the USB ports	29
4.2.5	Connecting the eco device	29
4.3	Decommissioning	31
<b>5</b>	<b>Operation</b>	<b>33</b>
5.1	Initial steps	33
5.1.1	Using the flexlid heated lid	33
5.2	Starting the Mastercycler nexus	34
5.2.1	Defining the administrator PIN	35
5.2.2	Other steps	36

5.3	Logging in and out as a user . . . . .	37
5.3.1	Logging in as a user . . . . .	37
5.3.2	Changing users . . . . .	38
5.3.3	Logging out as a user . . . . .	38
5.4	Overview of software operation . . . . .	39
5.4.1	Navigation tree overview . . . . .	39
5.4.2	Navigating in the navigation tree . . . . .	40
5.4.3	Using external storage media . . . . .	40
5.4.4	Selecting export file formats . . . . .	41
5.5	Managing folders and programs . . . . .	41
5.5.1	Creating folders and programs . . . . .	41
5.5.2	Copying folders and programs . . . . .	43
5.5.3	Deleting folders and programs . . . . .	43
5.6	Using the schedule . . . . .	44
5.6.1	Editing a schedule entry . . . . .	45
5.6.2	Displaying the schedule . . . . .	46
5.7	Using the power save mode . . . . .	47
<b>6</b>	<b>Programming . . . . .</b>	<b>49</b>
6.1	Overview of the program editor . . . . .	49
6.1.1	Opening the program editor . . . . .	49
6.1.2	Structure of the program editor . . . . .	49
6.2	Making general settings . . . . .	50
6.2.1	Opening the header . . . . .	50
6.2.2	Editing header settings . . . . .	50
6.3	Editing programs . . . . .	51
6.3.1	Inserting a program step . . . . .	51
6.3.2	Editing parameters . . . . .	53
6.3.3	Create gradient step . . . . .	54
6.3.4	Deleting program steps . . . . .	56
6.3.5	Exporting a program as a PDF or text file . . . . .	57
6.3.6	Saving a program and exiting the editor . . . . .	57
6.4	Program templates . . . . .	58
<b>7</b>	<b>PCR run . . . . .</b>	<b>59</b>
7.1	Loading the thermoblock . . . . .	59
7.1.1	Selecting the sample tubes . . . . .	59
7.1.2	Inserting the sample tubes . . . . .	60
7.2	Starting a program . . . . .	61
7.2.1	Status view . . . . .	62
7.2.2	Common status view for devices with a thermoblock with 64+32 wells . . . . .	63
7.3	Interrupting or stopping a program . . . . .	64
7.3.1	Interrupting a program . . . . .	64
7.3.2	Resuming a program . . . . .	64
7.3.3	Stopping a program . . . . .	64
7.4	Displaying the most recently run programs . . . . .	64



<b>8</b>	<b>System management</b>	<b>67</b>
8.1	Administrator functions	67
8.2	Managing user accounts	67
8.2.1	Creating a user account	67
8.2.2	Editing a user account	68
8.2.3	Deleting a user account	68
8.2.4	Changing the administrator PIN	69
8.3	System settings	70
8.4	Cycler functions	73
8.4.1	Cycler system functions	75
8.4.2	Self test	76
8.4.3	Displaying, printing or exporting the history	79
8.5	Managing and backing up data	80
8.5.1	Backing up data	80
8.5.2	Exporting and importing programs	81
8.6	Transferring programs from an older Mastercycler model	82
8.7	Network connection	83
8.7.1	Setting up a network connection	84
8.7.2	Setting up e-mail notifications	85
8.7.3	Setting up syslog messages	86
8.7.4	Activating remote access	88
<b>9</b>	<b>Quick start</b>	<b>89</b>
9.1	Login	89
9.2	Creating folders and programs	90
9.3	Copying folders and programs	90
9.4	Deleting folders and programs	91
9.5	Editing programs	91
9.6	Stopping and starting programs	93
<b>10</b>	<b>Maintenance</b>	<b>95</b>
10.1	Cleaning	95
10.1.1	Cleaning the housing	95
10.1.2	Cleaning the heated lid and the thermoblock	96
10.2	Disinfection/decontamination	96
10.3	Decontamination before shipment	96
<b>11</b>	<b>Troubleshooting</b>	<b>97</b>
11.1	General errors	97
<b>12</b>	<b>Transport, storage and disposal</b>	<b>99</b>
12.1	Packing	99
12.2	Disposal	99

<b>13 Technical data</b> .....	<b>101</b>
13.1 Power supply .....	101
13.2 Weight/dimensions .....	101
13.3 Ambient conditions .....	101
13.4 Application parameters .....	102
<b>Index</b> .....	<b>105</b>
<b>Certificates</b> .....	<b>109</b>

DOMINIQUE DUTSCHER SAS

# 1 Operating instructions

## 1.1 Using this manual









- ▶ Read this operating manual completely before using the device for the first time.
- ▶ Consider this manual as part of the product and keep it somewhere easily accessible.
- ▶ If this operating manual is lost, please request another one. The current version of the operating manual can be found on our webpage [www.eppendorf.com](http://www.eppendorf.com).

 The sequences of actions in this operating manual are described for operation using the control panel. You can also operate the Mastercycler nexus using the mouse (see p. 29).

## 1.2 Danger symbols and danger levels

### 1.2.1 Danger symbols

The safety instructions in this manual have the following danger symbols and danger levels:

	<b>Biohazard</b>		<b>Explosive substances</b>
	<b>Electric shock</b>		<b>Hot surfaces</b>
	<b>Risk of crushing</b>		<b>Toxic substances</b>
	<b>Hazard point</b>		<b>Material damage</b>

### 1.2.2 Danger levels

<b>DANGER</b>	<i>Will</i> lead to severe injuries or death.
<b>WARNING</b>	<i>May</i> lead to severe injuries or death.
<b>CAUTION</b>	May lead to light to moderate injuries.
<b>NOTICE</b>	May lead to material damage.

### 1.3 Symbols used

Depiction	Meaning
1. 2.	Actions in the specified order
▶	Actions without a specified order
•	List
<i>Text</i>	Display or software texts
<b>i</b>	Additional information

### 1.4 Abbreviations used

#### **DHCP**

Dynamic Host Configuration Protocol (network)

#### **DNS**

Domain Name System (network)

#### **IP**

Internet Protocol (network)

#### **MAC**

Media Access Control (network)

#### **PCL**

Printer Command Language – standard for printer control

#### **PCR**

Polymerase Chain Reaction

#### **PDF**

Portable Document Format

#### **PIN**

Personal Identification Number

#### **PS**

PostScript – standard for printer control

#### **SMTP**

Simple Mail Transfer Protocol (network)

#### **TSP**

Thermal Sample Protection

#### **USB**

Universal Serial Bus

## 1.5 Glossary

### F

#### **flexlid**

The heated lid of the thermal cycler automatically adapts to the used tubes or plates. This always ensures that a reliable pressure is applied to the thermoblock and that the tubes are sealed securely. Unlike conventional heated lids, they do not need to be manually adjusted.

### T

#### **Thermal Sample Protection**

When the heated lid is being heated, the thermoblock is actively maintained at a constant temperature. This minimizes non-specific annealing and evaporation of the samples.

#### **Triple circuit technology**

The thermoblock is controlled by three independent control loops. This is necessary to produce temperature gradients and leads to improved temperature homogeneity.

DOMINIQUE DUTSCHER SAS

DOMINIQUE DUTSCHER SAS

## 2 Safety

### 2.1 Intended use

The Mastercycler nexus is used for temperature control of aqueous solutions, suspensions or emulsions in closed micro test tubes for enzymatic reactions, typically the polymerase chain reaction (PCR).

The Mastercycler nexus is exclusively intended for indoor use.

All country-specific safety requirements for operating electrical equipment in laboratories must be observed.

The product can be used for training, routine and research laboratories in the areas of life sciences, industry or chemistry. This product is intended to be used for research purposes only. Eppendorf does not provide a warranty for other applications. The product is not suitable for use in diagnostic or therapeutic applications.

### 2.2 User profile

The device and accessories may only be operated by trained and skilled personnel.

Before using the device, read the operating manual and the instructions for use of the accessories carefully and familiarize yourself with the device's mode of operation.

### 2.3 Warnings for intended use

Read the operating manual and observe the following general safety instructions before using the Mastercycler nexus.



#### **DANGER! Risk of explosion.**

- ▶ Do not use the device in an explosive atmosphere.
- ▶ Do not operate the device in areas where work with explosive substances is carried out.
- ▶ Do not use this device to process any explosive or highly reactive substances.
- ▶ Do not use this device to process any substances which could create an explosive atmosphere.



#### **WARNING! Fire hazard.**

- ▶ Do not use this device to process any highly flammable liquids.

**WARNING! Damage to health due to infectious liquids and pathogenic germs.**

- ▶ When handling infectious liquids and pathogenic germs, observe the national regulations, the biosafety level of your laboratory, and the manufacturers' Safety Data Sheets and application notes.
- ▶ Wear your personal protective equipment.
- ▶ Consult the "Laboratory Biosafety Manual" (source: World Health Organization, Laboratory Biosafety Manual, as amended) for comprehensive regulations on the handling of germs or biological material of risk group II or higher.

**WARNING! Lethal voltages inside the device.**

Touching parts under high voltage can cause an electric shock. Electric shocks cause injuries to the heart and respiratory paralysis.

- ▶ Ensure that the housing is closed and undamaged.
  - ▶ Do not remove the housing.
  - ▶ Make sure that no liquids can enter the device.
- Only authorized service staff may open the device.

**WARNING! Biohazard when tempering with the heated lid open.**

When tempering with an open heated lid, the lids of the reaction vessels can spring open. This will release sample material.

- ▶ Only temper with a closed heated lid.

**WARNING! Biohazard due to unsuitable reaction vessels, plates and lids.**

Unsuitable reaction vessels, plates and lids will get damaged in the Cycler. This will release sample material.

- ▶ Only use reaction vessels, plates and lids that meet the requirements specified in the operating manual.

**CAUTION! Risk of burns on the thermoblock, heated lid and reaction vessels.**

The thermoblock, heated lid and reaction vessels reach temperatures of over 50 °C very quickly.

- ▶ Wait until the temperature of the thermoblock, heated lid and reaction vessels is below 30 °C.
- ▶ Then open the heated lid.

**CAUTION! Poor safety due to incorrect accessories and spare parts.**

The use of accessories and spare parts other than those recommended by Eppendorf may impair the safety, functioning and precision of the device. Eppendorf cannot be held liable or accept any liability for damage resulting from the use of accessories and spare parts other than those recommended or from improper use.

- ▶ Only use accessories and original spare parts recommended by Eppendorf.





**WARNING! Risk of injury when lifting the device.**

If the device is moved using the lid, the lid may break and cause the device to fall.

- ▶ Lift the device by the bottom of the housing.
- ▶ Use both hands to carry the device.
- ▶ Do not lift the device by its lid.



**CAUTION! Risk of injury due to lifting and carrying heavy loads**

The device is heavy. Lifting and carrying the device can lead to back injuries.

- ▶ Transport and lift the device with an adequate number of helpers.
- ▶ Use a transport aid for transporting the device.



**NOTICE! Damage to electronic components due to condensation.**

Condensate may form in the device after it has been moved from a cool environment to a warmer environment.

- ▶ After installing the device, wait for at least 12 h. Only then connect the device to the mains/ power line.

## 2.4 Danger symbols on the device

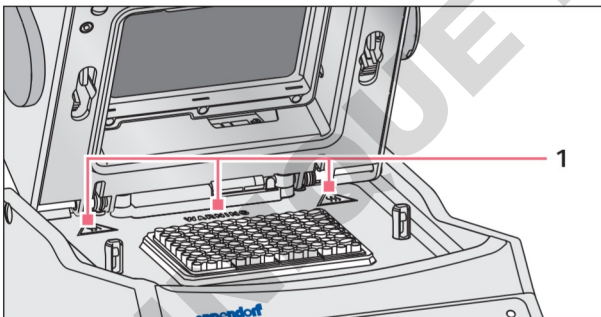

Fig. 2-1: Warning symbols on the Mastercycler

1



**Burns due to hot surfaces.**

If the heated lid is open, you may suffer burns when touching the thermoblock and the hot plate.

- ▶ Do not touch any hot surfaces.

DOMINIQUE DUTSCHER SAS

### 3 Product description

#### 3.1 Product overview

##### 3.1.1 Master variants

- Mastercycler nexus
- Mastercycler nexus gradient

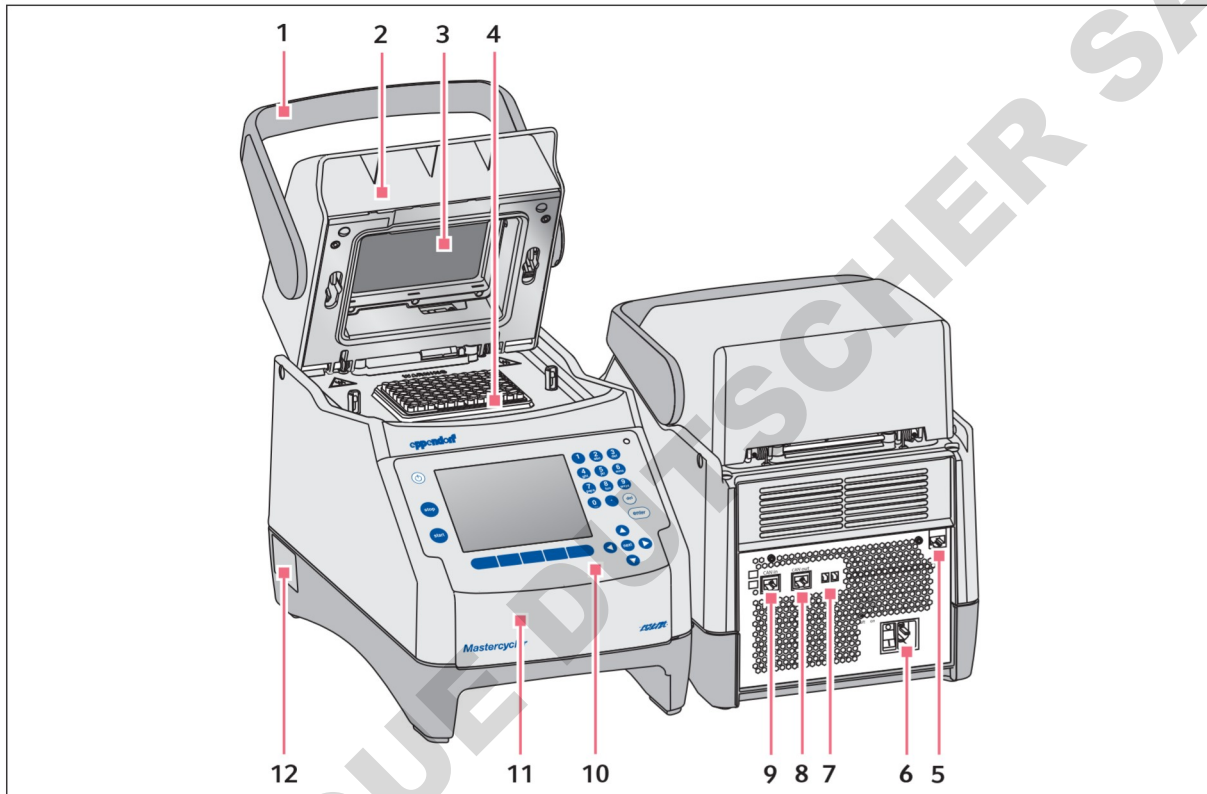

Fig. 3-1: Front and rear view

**1 Lid handle**

For opening and closing, and locking and unlocking the heated lid.

**2 Heated lid**

**3 Heating plate**

**4 Thermoblock**

**5 Ethernet port**

**6 Mains connection socket with power switch**

0 = off, I = on.

**7 Eco switch and Term switch**

**8 CAN out port**

**9 CAN in port**

**10 Control panel**

See detailed image (see p. 19)

**11 Lid**

Cover for the USB ports.

**12 Name plate**

### 3.1.2 Master variants with 64+32-well thermoblocks

- Mastercycler nexus X2
- Mastercycler nexus GX2

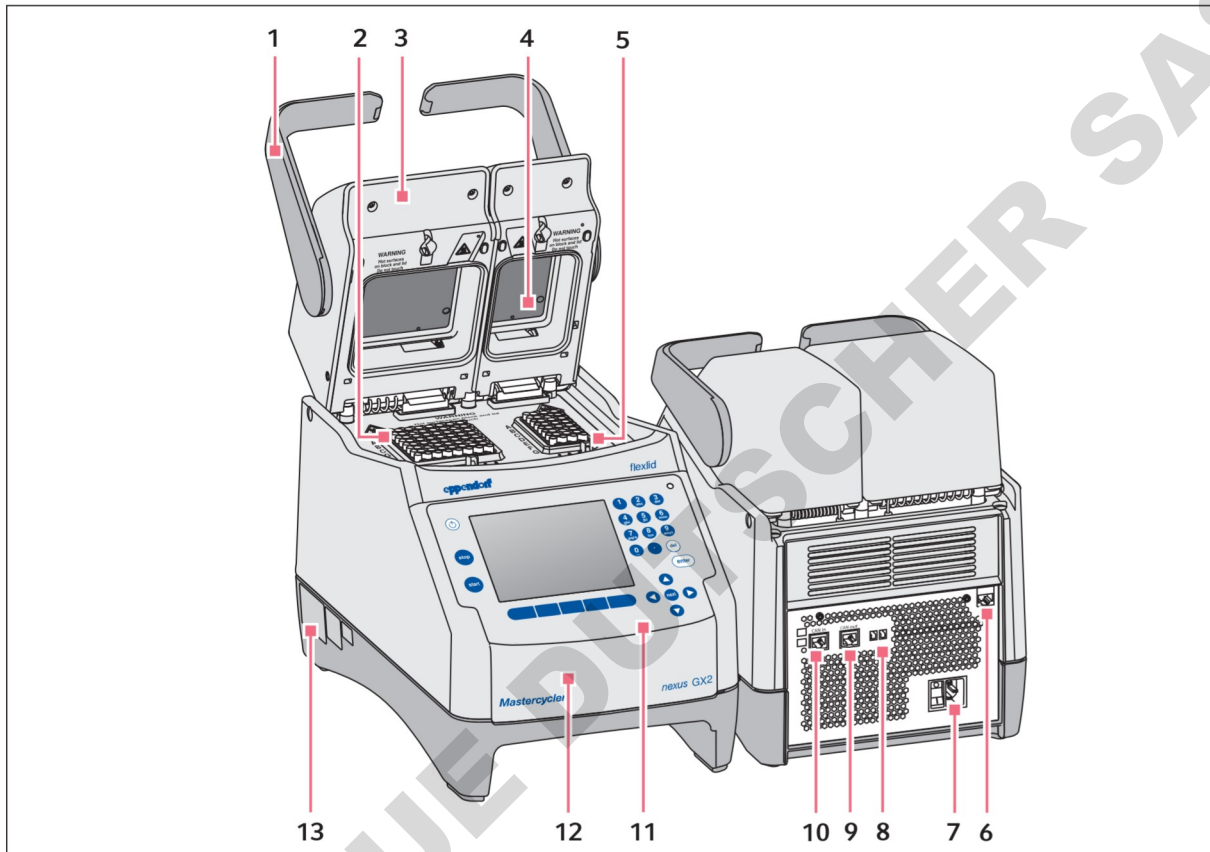

Fig. 3-2: Front and rear view

- |   |  |
|---|--|
| <p><b>1 Lid handle</b><br/>For opening and closing, and locking and unlocking the heated lid.</p> <p><b>2 Thermoblock with 64 wells</b></p> <p><b>3 Heated lid</b></p> <p><b>4 Heating plate</b></p> <p><b>5 Thermoblock with 32 wells</b></p> <p><b>6 Ethernet port</b></p> <p><b>7 Mains connection socket with power switch</b><br/>0 = off, I = on.</p> | <p><b>8 Eco switch and Term switch</b></p> <p><b>9 CAN out port</b></p> <p><b>10 CAN in port</b></p> <p><b>11 Control panel</b><br/>See detailed image (see p. 19)</p> <p><b>12 Lid</b><br/>Cover for the USB ports.</p> <p><b>13 Name plate</b></p> |
|---|--|

### 3.1.3 ECO variants

- Mastercycler nexus eco
- Mastercycler nexus gradient eco
- Mastercycler nexus X2e (with 64+32-well thermoblocks; not shown in the image)
- Mastercycler nexus GX2e (with 64+32-well thermoblocks; not shown in the image)

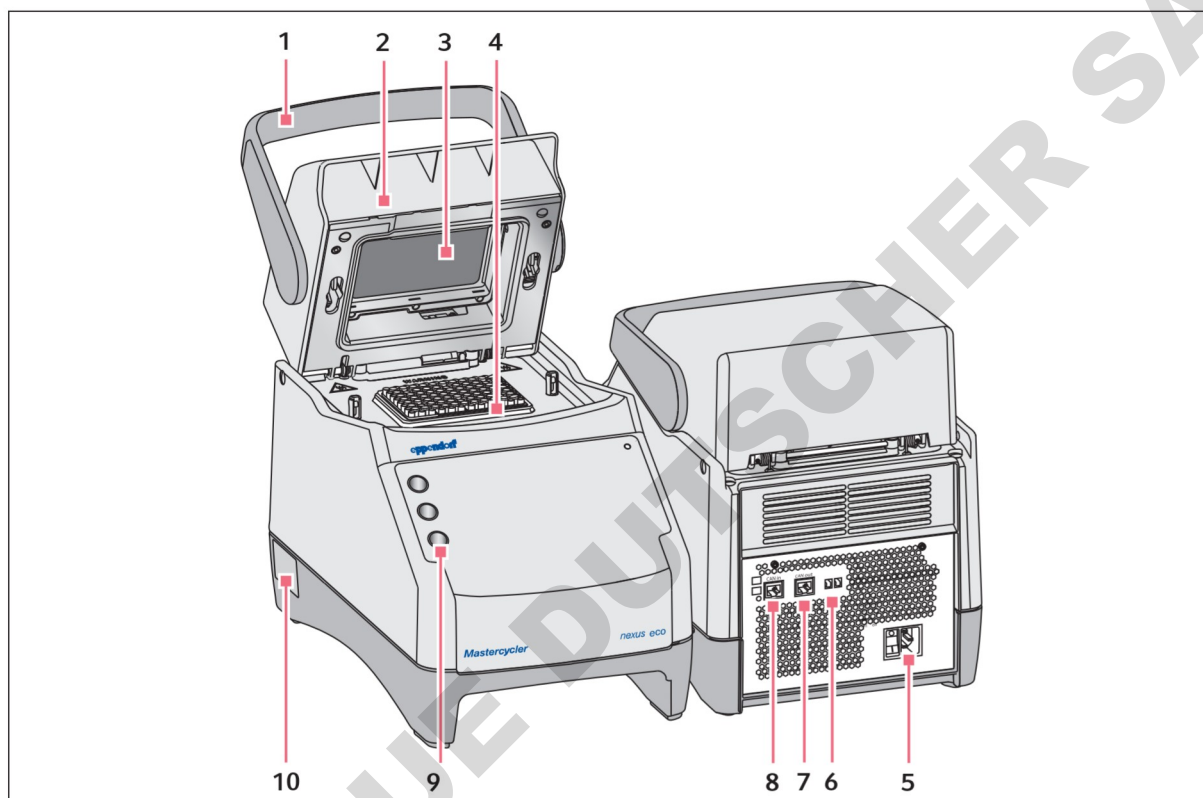

Fig. 3-3: Front and rear view

- |   |   |
|---|---|
| <b>1 Lid handle</b><br>For opening and closing, and locking and unlocking the heated lid. | <b>6 Eco switch and Term switch</b>                 |
| <b>2 Heated lid</b>   | <b>7 CAN out port</b>                               |
| <b>3 Heating plate</b>  | <b>8 CAN in port</b>                                |
| <b>4 Thermoblock</b>  | <b>9 Pen holder</b><br>Holder for up to three pens. |
| <b>5 Mains connection socket with power switch</b><br>0 = off, I = on.                    | <b>10 Name plate</b>                                |

### 3.1.4 Terminal block

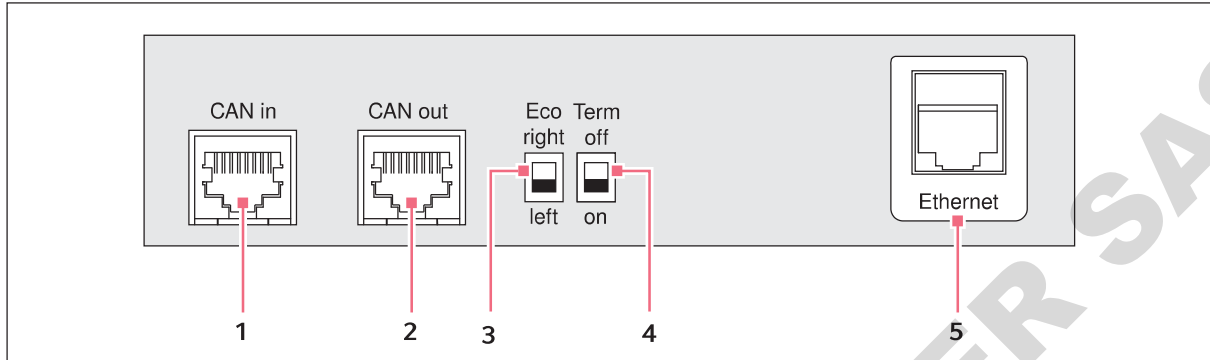

Fig. 3-4: Terminal block

- |  |   |
|--|---|
| <p><b>1 CAN in port</b><br/>For connection with an eco device.</p> <p><b>2 CAN out port</b><br/>For connection with a further eco device.</p> <p><b>3 Eco switch</b><br/>For setting the position of an eco device (to the left or right next to a master variant with control panel).</p> | <p><b>4 Term switch</b><br/>Termination of the CAN data connection when networked with the eco device.</p> <p><b>5 Ethernet port (not on an eco device)</b><br/>For connecting a master variant of the Mastercycler nexus with an Ethernet network.</p> |
|--|---|

Only connect devices to the interfaces of the Mastercycler nexus that comply with the IEC 950/EN 60950 (UL 1950) standards.

### 3.1.5 Control panel

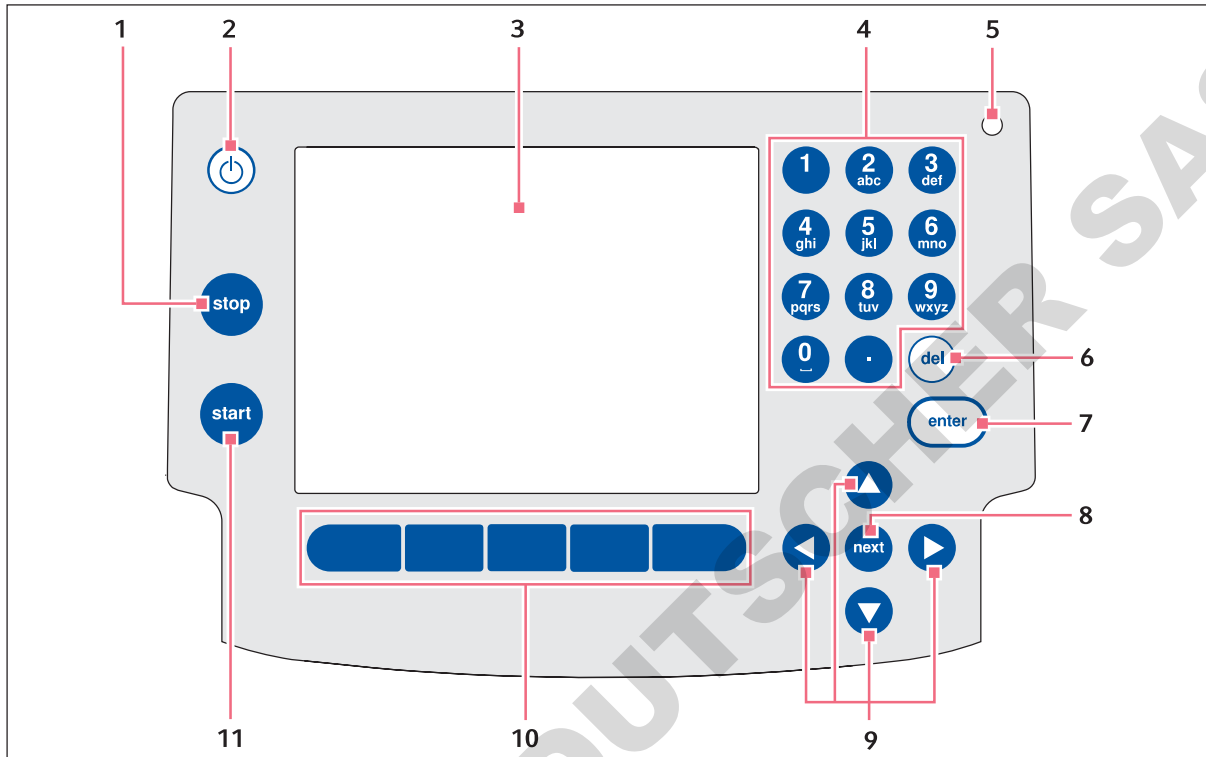

Fig. 3-5: Control panel

- |   |   |
|---|---|
| <p><b>1 stop key</b><br/>For stopping a running program.</p> <p><b>2 Standby key</b><br/>For putting the device into power saving mode.</p> <p><b>3 Display</b></p> <p><b>4 Number pad</b></p> <p><b>5 Status lamp</b><br/>On devices with 64+32-well thermoblocks, the status lamp is deactivated on the control panel. The active status lamps is located on the heated lid on devices with 64+32-well thermoblocks.</p> <p><b>6 del key</b><br/>For deleting characters to the right of the cursor and marked objects.</p> | <p><b>7 enter key</b><br/>For confirming entries and opening selection lists.</p> <p><b>8 next key</b><br/>For moving the cursor to the next edit box.</p> <p><b>9 Arrow keys</b><br/>For moving the cursor.</p> <p><b>10 Softkeys</b><br/>Functions change with the software dialog, these each appear on the display above the softkey.</p> <p><b>11 start key</b><br/>For starting the selected program.</p> |
|---|---|

### 3.1.6 Number pad



For entering numbers and text in edit boxes. For numerical edit boxes (e.g., temperature, time) the keys are only assigned to numbers. For decimal numbers with decimal places, use the period as the decimal sign. For alphanumerical edit boxes, the keys are assigned multiple characters.

- ▶ To enter text, press the key with the corresponding letter until the desired letter is shown.

**Example:** To enter *pcr 3* in a text field, press each of the following keys in quick succession:

1. For *p*: Press **7** once.
2. For *c*: Press **2** three times.
3. For *r*: Press **7** three times.
4. For the space: Press **0** (zero) two times.
5. For *3*: Press **3** four times.

### 3.1.7 Status lamp

Status lamp	Operating status
flashes briefly in green	The device is in standby mode. The display is off for this.
Is lit in green	The device is idling.
Flashes in green	A program run is active.
Flashes in orange	The program run is waiting for user action in the Pause or Hold step.
Flashes in red	A error has occurred. Additional information on the error type is shown in the display.

## 3.2 Delivery package

Quantity	Description
1	Mastercycler nexus as ordered
1	Operating manual for all Master versions. Eco devices are delivered without an operating manual.
1	Certificate of Conformity
1	Mains/power cord
1	CAN bus cable (only with eco devices)



### 3.3 Features

#### Triple circuit technology

The triple circuit technology leads to a homogeneous temperature distribution and enables a selective generation of temperature gradients for PCR optimizations with the Mastercycler nexus gradient and Mastercycler nexus GX2.

#### SteadySlope

The SteadySlope technology ensures that the heating and cooling rates of the thermoblock in gradient operation are identical to those in normal operation. The reliable transfer of optimization results to the routine application is ensured.

#### flexlid

All variants of the Mastercycler nexus have a flexlid heated lid. It enables ergonomic one-hand operation and automatically adjusts the contact pressure for all tubes and PCR plates.

#### Thermal Sample Protection

The Thermal Sample Protection technology maintains a constant thermoblock temperature of 20°C during the warm-up phase of the heated lid. Thermal Sample Protection reduces the thermal load on your samples and minimizes the probability of non-specific product formation during the PCR.

#### Self test function

With the *Self Test* function, the following properties of the thermoblock can be tested:

- Heating and cooling rates
- Proper functioning of the temperature control loops
- Temperature homogeneity in each of the three block zones (left, middle and right zone)
- Temperature homogeneity throughout the entire block

After a successful self test, a certificate can be generated in PDF format.

#### Control

The eco variants of the Mastercycler nexus do not have a control panel. They are controlled via a connected master variant of the Mastercycler nexus.

#### Standby function

All variants of the Mastercycler nexus can be switched to standby mode automatically or by pressing a key. This reduces energy consumption and ensures that the device is ready for use at any time.

### 3.3.1 Features of the Mastercycler nexus

	<b>Thermoblock version</b>	<b>Thermoblock material</b>	<b>Freely programmable temperature gradient (gradient spread)</b>
Mastercycler nexus gradient	96-well format	Aluminum	X (max. 20°C)
Mastercycler nexus gradient eco	96-well format	Aluminum	X (max. 20°C)
Mastercycler nexus	96-well format	Aluminum	
Mastercycler nexus eco	96-well format	Aluminum	
Mastercycler nexus GX2	64-well format and 32-well format	Aluminum	X (max. 12°C)
Mastercycler nexus GX2e	64-well format and 32-well format	Aluminum	X (max. 12°C)
Mastercycler nexus X2	64-well format and 32-well format	Aluminum	
Mastercycler nexus X2e	64-well format and 32-well format	Aluminum	

### 3.3.2 Control panel and ports

	<b>Control panel</b>	<b>Ethernet port</b>	<b>USB port</b>
Mastercycler nexus gradient	X	X	2
Mastercycler nexus gradient eco	—	—	—
Mastercycler nexus	X	X	2
Mastercycler nexus eco	—	—	—
Mastercycler nexus GX2	X	X	2
Mastercycler nexus GX2e	—	—	—
Mastercycler nexus X2	X	X	2
Mastercycler nexus X2e	—	—	—

### 3.3.3 Consumables

	PCR tubes (0.1 mL or 0.2 mL)	PCR tubes *)(0.5 mL)	PCR plates
Mastercycler nexus gradient	96	71	1x 96-well
Mastercycler nexus gradient eco	96	71	1x 96-well
Mastercycler nexus	96	71	1x 96-well
Mastercycler nexus eco	96	71	1x 96-well
Mastercycler nexus GX2	64 + 32	45 + 19	2x 32-well 1x 32-well or segments of separable 96-well PCR plates
Mastercycler nexus GX2e	64 + 32	45 + 19	2x 32-well 1x 32-well or segments of separable 96-well PCR plates
Mastercycler nexus X2	64 + 32	45 + 19	2x 32-well 1x 32-well or segments of separable 96-well PCR plates
Mastercycler nexus X2e	64 + 32	45 + 19	2x 32-well 1x 32-well or segments of separable 96-well PCR plates

\*) In the case of 0.5 mL tubes with a bigger lid, the number of usable sample places can be lower.

### 3.3.4 Networking

You can connect and control up to any two eco devices to a master variant of the Mastercycler nexus.

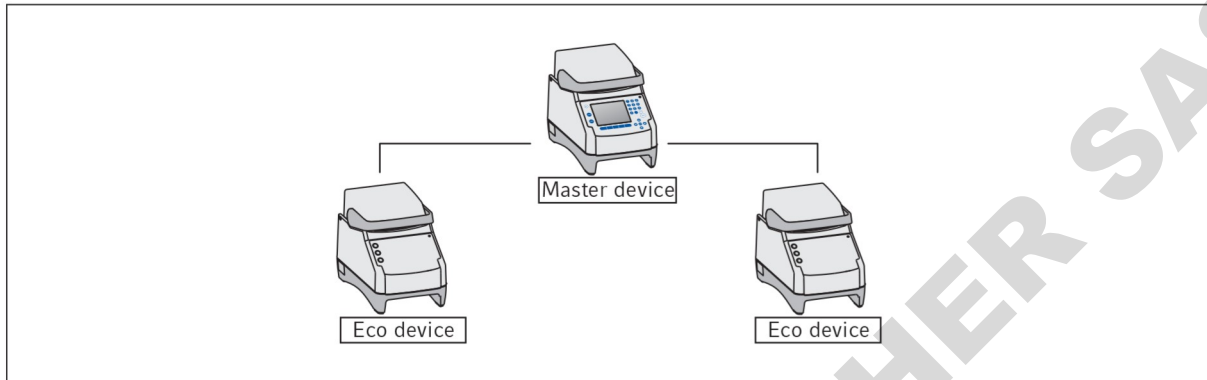

### 3.3.5 Service

Eppendorf offers customized service options for preventive maintenance and verification of your thermal cycler. For more information, service requests and local offers visit [www.eppendorf.com/epServices](http://www.eppendorf.com/epServices) and the local websites.

## 4 Installation

### 4.1 Selecting the location



**WARNING! Risk of injury due to unsuitable work surface.**

The device may fall down if placed on an unsuitable work surface.

- ▶ Observe the criteria for selecting a location. The criteria can be found in the operating manual.



**NOTICE! Damage due to overheating.**

- ▶ Do not install the device near heat sources (e.g., heating, drying cabinets).
- ▶ Do not expose the device to direct sunlight.
- ▶ Ensure unobstructed air circulation. Maintain a clearance of at least 30 cm around all ventilation gaps.



When the device is in operation, ensure that the device mains/power switch and the cutting unit of the power system circuit (e.g., residual current circuit breaker) are accessible.

Information regarding the dimensions and weight of device components can be found in a separate section (see *Weight/dimensions on p. 101*).

Take the following criteria into account when selecting the location for the device:

- The surface must have sufficient bearing capacity and ensure the required stability.
- The surface must be free of vibration.
- The device feet must not slip.
- The height of the location should allow for convenient and safe operation of the device.

## 4.2 Installing the device

This section describes how to put the device into operation and how to connect one or two eco devices to a master variant of the Mastercycler nexus.

### 4.2.1 Connecting the device to the mains/power line



**WARNING! Danger due to incorrect voltage supply.**

- ▶ Only connect the device to voltage sources which correspond with the electrical requirements on the name plate.
- ▶ Only use earth/grounded sockets with a protective earth (PE) conductor.
- ▶ Only use the mains/power cord supplied.



**NOTICE! Sample loss through interruption in the mains/power supply.**

If you use multiple sockets, the current consumption of several devices may exceed the power current strength. The mains/power fuse interrupts the mains/power supply. The devices do not receive any power. The current programs are aborted.

- ▶ Connect the mains/power cord of each device directly to an earth/grounded socket.
- ▶ Do not use multiple sockets.

Information on the power consumption of the Mastercycler nexus is provided separately (see *Power supply on p. 101*).

- ▶ Connect the mains connection socket to the power socket using a power cable.

#### 4.2.2 Attaching devices to each other

You can attach adjacent devices to each other to prevent individual devices from slipping and avoid mechanical stress on the cables.

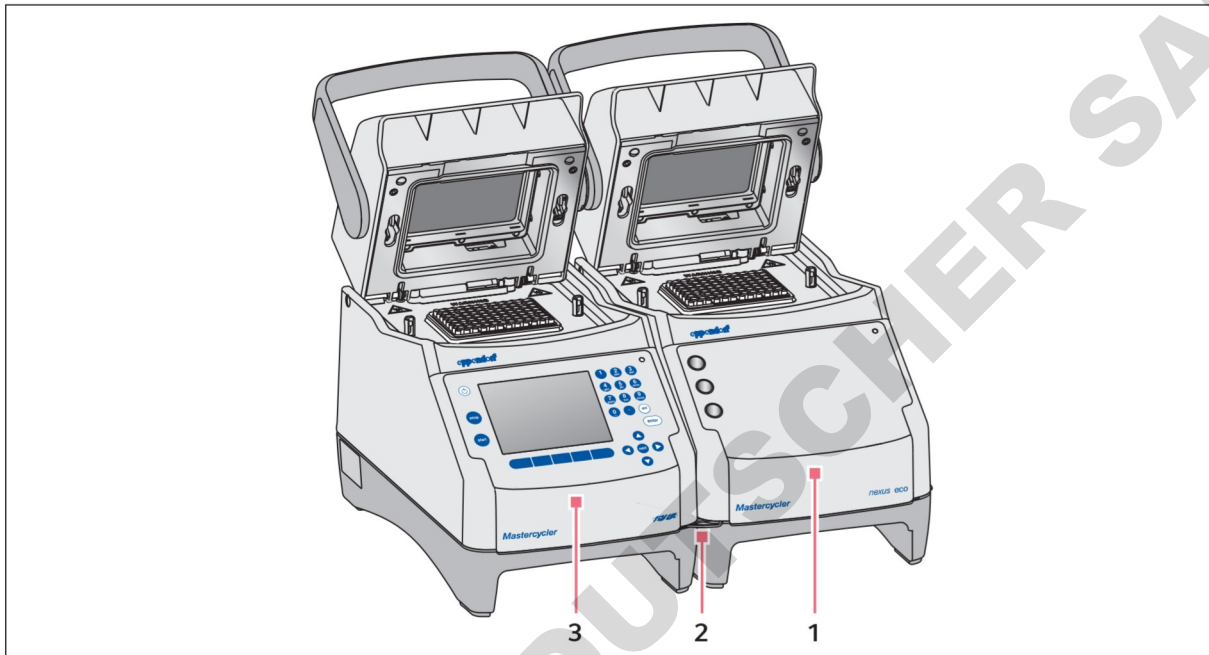

Fig. 4-1: Example: two Mastercycler nexus attached to each other

1 Eco variant Mastercycler nexus

3 Master variant Mastercycler nexus

2 Bracket

**Installation**

Mastercycler® nexus  
English (EN)

**CAUTION! Danger from devices falling down.**

The bracket can break or be released from the recess in the housing if you move or lift devices that are attached to each other. Devices could fall down and cause injury.

- ▶ Do not lift devices that are attached to each other with the bracket.
- ▶ Do not move devices that are attached to each other with the bracket.
- ▶ Separate the devices before lifting or moving them.

1. Position the devices next to each other.

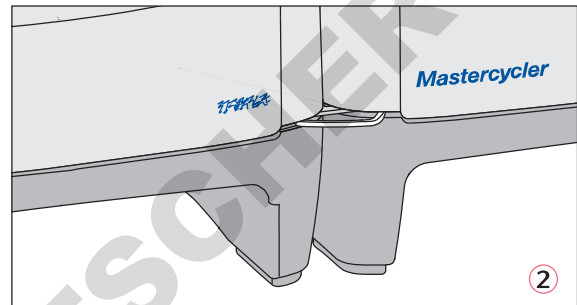
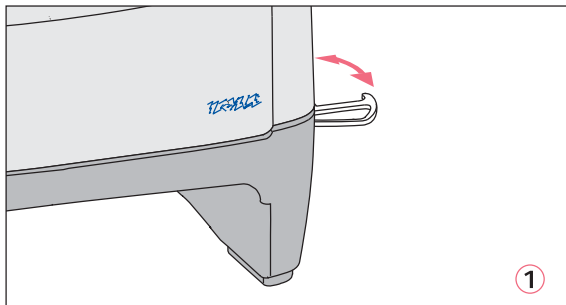

2. Fold out the bracket of the device on the left ①. Insert the bracket into the recess in the housing of the device on the right ②.
3. Align the devices attached to each other in parallel.

**4.2.3 Separating devices**

1. Switch off the devices at the power switch. Disconnect the cable connections at the rear of the devices.
2. Hold the bracket and push the device on the right back until the bracket comes out of the recess in the housing.
3. Fold the bracket away.



#### 4.2.4 Using the USB ports

The master variants of the Mastercycler nexus have two USB ports for the connection of a mouse, a printer and a storage medium.



- Use a USB hub if you would like to connect more than two USB devices at the same time.
- The USB printer must be compatible with the **PostScript®** or **PCL** printer standards. Further information can be found in the operating manual for your printer.
- The eco devices do not have any USB ports.

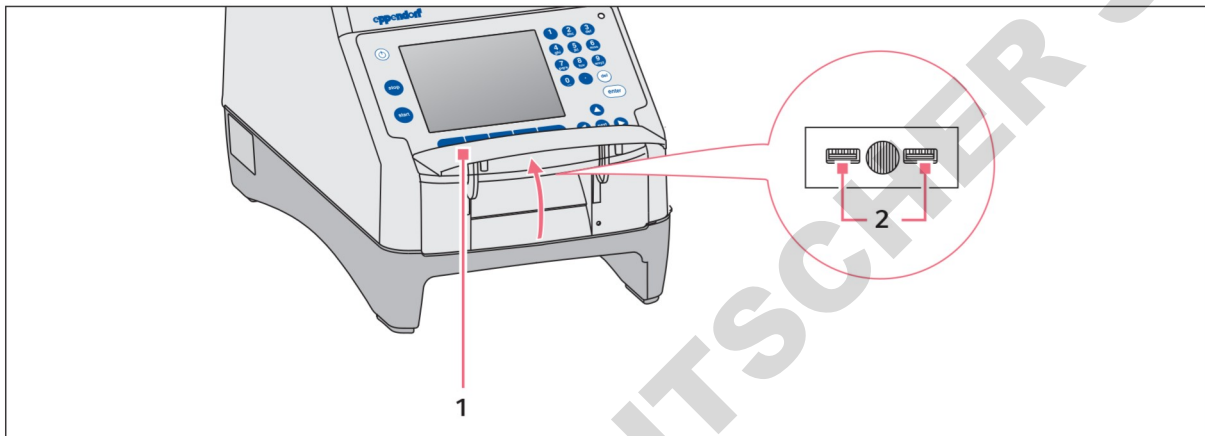

1. Open the flap (1) to access the USB ports (2).
2. Insert the USB device into one of the two ports.  
 Newly connected USB devices are automatically detected during operation.
3. Close the flap.

#### 4.2.5 Connecting the eco device

This section explains how to operate one or two eco devices together with a master variant of the Mastercycler nexus. The eco device is controlled via a master variant Mastercycler nexus. This requires a cable connection between the devices. Use Eppendorf CAN-bus cables for this.

##### Connecting a single eco device

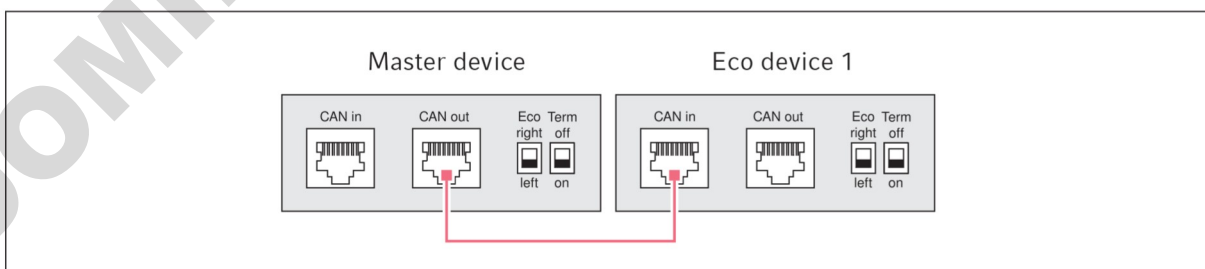

Fig. 4-2: Wiring diagram showing rear view of the devices

### Connecting two eco devices

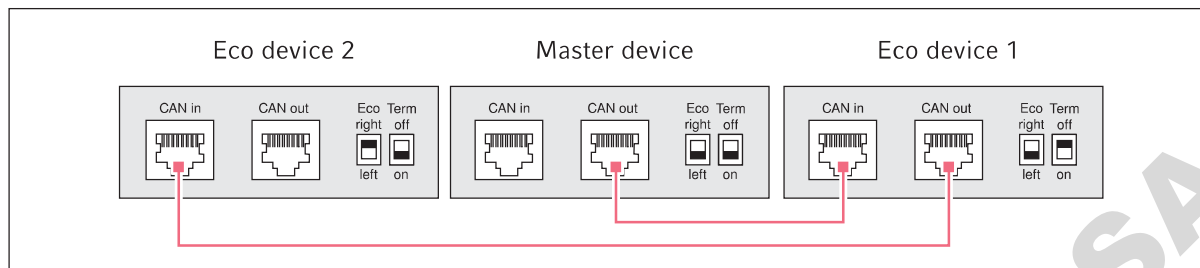

Fig. 4-3: Wiring diagram showing rear view of the devices

The connections and switches are located on the rear of the devices.

#### 4.2.5.1 Establishing the data connection

1. Switch off all devices at the power switch.

##### Connecting the first eco device

2. Connect the CAN bus cable to the **CAN out** port of the Mastercycler nexus (with control panel) and to the **CAN in** port of the eco device.

##### Connecting the second eco device

3. Connect the second CAN bus cable to the **CAN out** port of the first eco device and to the **CAN in** port of the second eco device.

#### 4.2.5.2 Setting the Eco and Term switches

You must set the **Eco** and **Term** switches on all devices depending on whether you have connected one or two eco devices to a master variant of the Mastercycler nexus.

- Set the **Eco** and **Term** switches on the rear of all connected devices as follows:

Connected devices	Master device		Eco device 1		Eco device 2	
One eco device	Eco right  left	Term off  on	Eco right  left	Term off  on	—	—
Two eco devices	Eco right  left	Term off  on	Eco right  left	Term off  on	Eco right  left	Term off  on



- The position of the **Eco** switch of the eco device should reflect its installation position on the left or right next to a master variant of the Mastercycler nexus with control panel.
- If you operate the Mastercycler nexus on its own, the position of the **Eco** and **Term** switches is not important.

### 4.3 Decommissioning

Proceed as follows if you do not want to use the Mastercycler nexus for longer than a week.

1. Load the block with an empty PCR plate or tube.
2. Close the heated lid and flip the handle forwards .
3. Disconnect the Mastercycler nexus from the power supply.

Never leave the lid of the Mastercycler nexus open to prevent contamination of the block.

DOMINIQUE DUTSCHER SAS

DOMINIQUE DUTSCHER SAS

## 5 Operation

### 5.1 Initial steps

#### Checking the correct installation

Before the Mastercycler nexus is commissioned for the first time, ensure that the following requirements are met:

- The device is correctly connected.
- The device is free of damage.
- Free circulation of air around the ventilation slots at the rear of the device and at the fan behind the front feet has been guaranteed.

#### 5.1.1 Using the flexlid heated lid

The Mastercycler nexus is equipped with a flexlid heated lid. The flexlid heated lid automatically adjusts to the height of the used PCR tubes or PCR plates. It can be operated with one hand. Manual adjustment to the tube height, or adjusting the contact pressure to the tube lids, is not required.

The heated lid ensures uniform contact between the tubes and the thermoblock, and secures the tube lids against leaks. The heating process prevents condensation from forming in the upper area of the tube during the tempering of the reaction liquid.

##### 5.1.1.1 Open heated lid



**WARNING! Biohazard when tempering with the heated lid open.**

When tempering with an open heated lid, the lids of the reaction vessels can spring open. This will release sample material.

- ▶ Only temper with a closed heated lid.



**CAUTION! Risk of burns on the thermoblock, heated lid and reaction vessels.**

The thermoblock, heated lid and reaction vessels reach temperatures of over 50 °C very quickly.

- ▶ Wait until the temperature of the thermoblock, heated lid and reaction vessels is below 30 °C.
- ▶ Then open the heated lid.

---

Open the heated lid in one go as follows:

- ▶ Flip the lid handle up over the heated lid and flip the heated lid up at the lid handle as far as it will go.

### 5.1.1.2 Closing the heated lid

#### Prerequisites

Thermoblock loaded with sample tubes or a PCR plate.



#### CAUTION! Risk of crushing when closing the heated lid.

- ▶ Hold the middle of the handle on the heated lid.
- ▶ When you close the heated lid, do not place your fingers between the heated lid and the housing.



Comply with the guidelines for loading the thermoblock with PCR tubes (see *Loading the thermoblock on p. 59*).

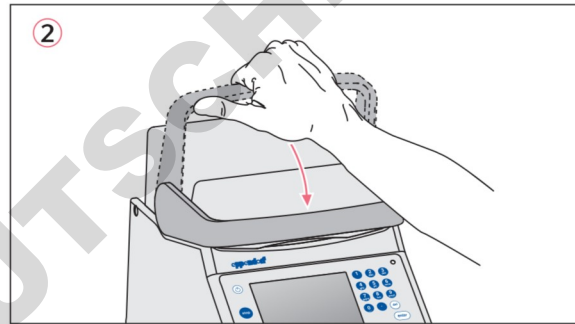
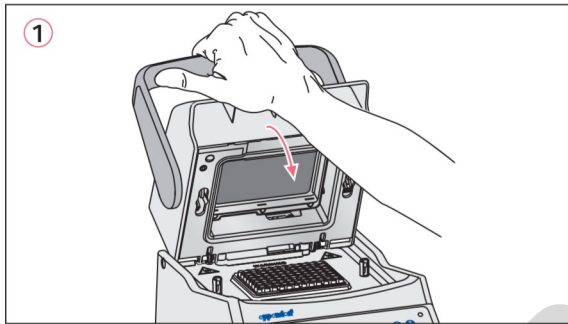

1. Grip the heated lid at the center of the lid handle and close it **(1)**.
2. Continue to move the lid handle further down until it is in a horizontal position **(2)**.



The force required to move the lid handle into the horizontal position depends on the type of PCR tubes or PCR plate used.

The heated lid is now locked. You can now start a program run or manually temper the heated lid and samples.

## 5.2 Starting the Mastercycler nexus

#### Prerequisites

The Mastercycler nexus is properly set up and connected to the power supply.

- ▶ Switch on the device using the power switch at the back (see p. 15).  
 The status lamp lights up and the fan starts.  
 The display illumination is switched on (not for Mastercycler nexus eco).

### 5.2.1 Defining the administrator PIN

The first time the device is started, you can define an administrator PIN to protect it against unauthorized access. The administrator PIN is saved and will be maintained even when the Mastercycler nexus is switched off.

If an administrator PIN has not been defined, you will be prompted to define one.



**NOTICE! Data loss due to unauthorized use of the administrator password.**

The administrator password protects the device software from unwanted access.

- ▶ Make a note of the administrator password.
- ▶ Store the administrator password in a secure location.
- ▶ Only provide the administrator password to individuals who work with the system configuration.
- ▶ Please contact Eppendorf SE if you have any problems with the administrator password.



- If you do not want to use user management, you do not need to define an administrator PIN. In this case, leave the input fields in the *Input Admin PIN* window blank and deactivate the *PIN* function. Further information on user management can be found separately (see *System settings on p. 70*).
- If the *PIN* function is activated (see *System settings on p. 70*), you must define an administrator PIN. If you do not do this, the input prompt will appear each time the device is switched on.
- You can also change the administrator PIN at a later time (see *Changing the administrator PIN on p. 69*).

To define the administrator PIN, perform the following steps in the sequence described.

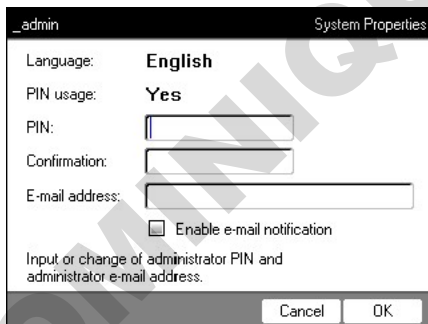

1. Switch on the Mastercycler nexus at the power switch. The *Input Admin PIN* window appears.
2. Enter the desired administrator PIN using the numeric keys.



3. Re-enter the PIN in the *Confirmation:* field.



4. An error message appears if the two PIN entries do not match. If this happens, delete the incorrectly entered PIN and reenter the PIN twice.

5. Optional: enter the administrator's e-mail address for receiving messages from the Mastercycler nexus in the *E-mail address:* field (see p. 85).
6. Optional: select *Enable e-mail notification* to activate e-mail notifications for the administrator.
7. Press the *OK* softkey.

After the successful confirmation of the administrator PIN, the navigation tree appears on the display. You are now logged in as the administrator.

## 5.2.2 Other steps

### 5.2.2.1 Changing the language

You can change the language of the user interface of the Mastercycler nexus (see *System settings on p. 70*).

#### 5.2.2.2 Set date and time

The date and time are shown in the upper right corner of the display. As the administrator, you can change this internal clock at any time (see *System settings on p. 70*).

#### 5.2.2.3 Setting up user accounts

To be able to use the Mastercycler nexus, you must set up at least one user account. Detailed information on user management and how to set up user accounts can be found separately (see *Managing user accounts on p. 67*).



### 5.3 Logging in and out as a user

**i** The functions described here are only available if the PIN function is activated (see *System settings* on p. 70).

#### 5.3.1 Logging in as a user

To be able to log in with your user name, your administrator must have set up a user account for you.

Proceed as follows:



1. Open the list by pressing the **enter** key, and select your user name.

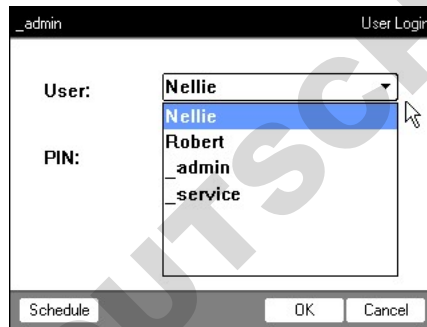

2. Press the **next** key.  
The cursor jumps to the *PIN:* field.



3. Enter your PIN via the numerical keys.  
If the PIN is wrong, *Wrong PIN* appears. Press the *Login* softkey to return to the *User Login* window, delete the wrong PIN entry with the *Delete* key, and enter the correct PIN.
4. Press the *OK* softkey to confirm.  
The navigation tree is displayed.

You are now logged in with your user name and can work with the Mastercycler nexus.

### 5.3.2 Changing users

Only one user can be logged in at a time. Proceed as follows to switch between users:

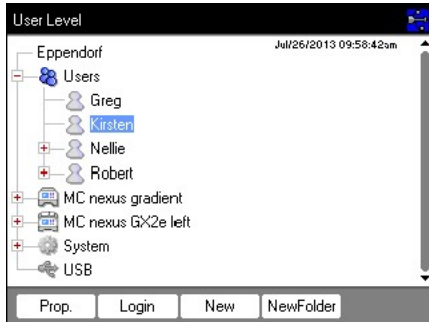

1. Select either your user node or the *Other Users* user node.
2. Press the *Login* softkey.
3. Log in as a user.  
 The previously logged-in user is automatically logged out.

### 5.3.3 Logging out as a user

You can log out to protect your programs against unauthorized changes.

1. Select your user node.
2. Press the *Logout* softkey.

You are now logged out.

The guest user is automatically logged in. The guest user cannot start programs and only has read access to all programs and folders.

## 5.4 Overview of software operation

### 5.4.1 Navigation tree overview

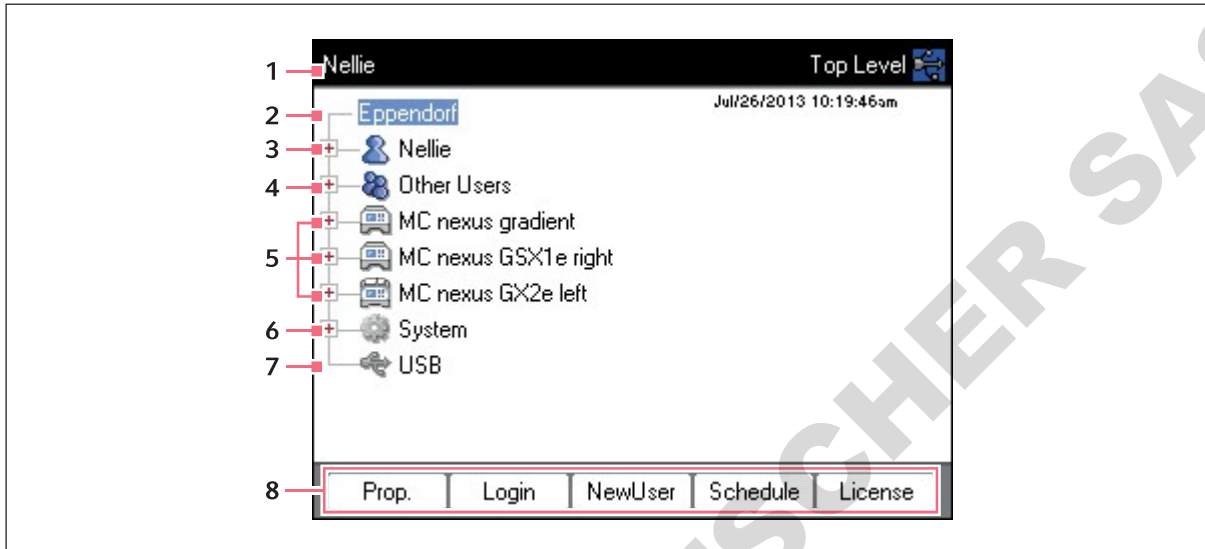

#### 1 Window title

Current level in the navigation tree or title of a dialog box.

#### 2 Eppendorf node

The main node which contains all other nodes.

#### 3 User node

Contains the programs and folders as well as the list of the 5 most recently started programs of the logged-in user.

#### 4 Other Users node

Contains the nodes of the users that are not currently logged in if PINs are used (see p. 70).

#### 5 Cyclers node

Each cycler that is connected and switched on is shown as a separate node. The cycler node can be used to display the cycler status and execute functions.

#### 6 System node

This node contains the most important system settings. Some settings can only be edited by the administrator.

#### 7 USB node

This node is only visible if a USB storage medium has been inserted. Use this node to transfer programs and perform data backups.

#### 8 Softkeys



The 5 softkeys have context-specific functions, depending on the selected node or active window.

## 5.4.2 Navigating in the navigation tree

### 5.4.2.1 Opening the node

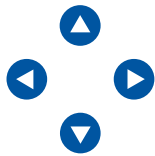
You have three options:



- ▶ Mark the node with the arrow keys and press the **enter** key or the  arrow key. The node opens and the  symbol changes to .



- ▶ Alternatively, click on the  symbol next to the node.





- ▶ Alternatively, use the mouse to double-click on the desired node.

### 5.4.2.2 Closing the node

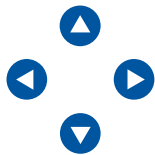
Carry out the above-mentioned steps in the reverse order:



- ▶ Click on the  symbol next to the node.
- ▶ Alternatively, double-click on the node with the mouse.

- ▶ Alternatively, mark the node with the arrow keys and press the **enter** key or the  arrow key. The node is closed and the  symbol next to the node changes to .

## 5.4.3 Using external storage media

You can back up programs, log files and protocols to a storage medium and, for example, archive them on a PC or print them. External storage media are also needed for data backups and software updates (see p. 70).

### 5.4.3.1 Connecting a USB storage medium

- ▶ Connect a USB storage medium to a USB port.

After a few seconds, the *USB* node appears in the navigation tree. The programs and user nodes saved on the USB storage medium can be accessed via this node.



The Mastercycler creates a folder called `\leppendorf` on the USB storage medium where all files will be saved.

### 5.4.3.2 Removing the USB storage medium

**Caution!** The  symbol is displayed in the upper right corner while the storage medium is being accessed. Wait until it has disappeared before removing the USB storage medium.

- ▶ Remove the USB storage medium.  
 The *USB* node disappears from the navigation tree.

### 5.4.4 Selecting export file formats

When exporting programs, protocols and log files to external storage media, you can choose between text-only format (.TXT) and PDF.

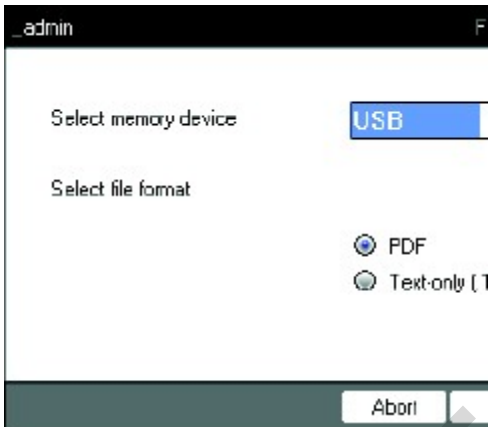

The screenshot shows a dialog box with a title bar containing the user name 'admin'. It has two main sections: 'Select memory device' with a dropdown menu showing 'USB', and 'Select file format' with two radio button options: 'PDF' (which is selected) and 'Text-only [1]'. At the bottom right, there is an 'Abort' button.

- ▶ *Select memory device*  
 Storage medium for the exported file.
- ▶ *Select file format*
  - *PDF*: Saves the file as a PDF.  
 Use this setting if you only want to print or view the documents on your PC. You need to have a PDF reader software installed (e.g. Adobe® Reader®).
  - *Text-only (.TXT)*: Saves the file in text-only format (.TXT).  
 Use this setting if you want to process the document content electronically (e.g. embed it in a report).
- ▶ Confirm your selection with *OK*.

The file is copied to the external storage medium, and the file name is displayed.

## 5.5 Managing folders and programs

 If you are logged in as a normal user (not as an administrator), you can only create, edit and delete programs below your own user node. Further information on user rights can be found in a separate section (see *Administrator functions on p. 67*).

### 5.5.1 Creating folders and programs

#### 5.5.1.1 Creating a folder

Proceed as follows:

1. Mark the user node.
2. Press the *NewFolder* softkey.
3. Enter a name for the new folder using the numeric keys.

 Instead of the numeric keys, you can also use the software keyboard to make entries in text fields. This can be accessed via the *Keybd* key.

4. To enter a comment for the new folder, use the **next** key to go to the *Comment:* field.
5. Enter your comment via the numerical keys and confirm with *OK*.  
 The folder is created and appears under your user node in the navigation tree.



You can change the name and comment for the folder at any time using the *Prop.* softkey.

### 5.5.1.2 Creating a new program

You can create programs in the navigation tree on the user node level or on the folder level.

1. In the navigation tree, mark the user node or folder where you want to create the new program.
2. Press the *New* softkey.

3. Enter the program name in the *Name:* field. The maximum number of characters is 21.
4. Select a program template in the *Use template:* field.  
 An overview of the available program templates can be found separately (see p. 58). If you do not want to use a template, select *none*.
5. Optional: enter a comment for the new program in the *Comment* field.
6. Press the *OK* softkey.  
 The new program opens in the program editor. You can now configure and save the program (see p. 49).



You can change the program properties at a later time. To do so, mark the program in the navigation tree and press the *Prop.* softkey. The following properties can be changed:

- Program name
- Comment for the program
- Read/write access rights for the program

### 5.5.2 Copying folders and programs

To copy folders or programs into your own user node, proceed as follows. When copying a folder, the programs it contains are also automatically copied.

1. In the user node of any user, mark the folder or program you want to copy.
2. Press the *Copy* softkey.  
A message appears informing you that the folder or the program was copied to the clipboard.
3. Press *OK* to confirm the message.
4. Mark your own user node. If you want to copy an individual program, you can also select a folder under your user node to which you want to copy the program.
5. Press the *Paste* softkey.  
If a program or folder already exists with the same name, you will be prompted to enter a new name. The folder or program is pasted below your user node. You can now start or edit this program.

### 5.5.3 Deleting folders and programs

1. In the navigation tree, mark the folder or the program.
2. Press the **del** key.  
A confirmation prompt appears.
3. Press the *Yes* softkey.  
The folder or program is deleted.

## 5.6 Using the schedule

The schedule enables users to reserve devices for a specific time. You can view the schedule at any time or use it as an automatic screensaver. Use the *System > Schedule Settings* node to set the devices and weekdays for the schedule. Past schedule entries are automatically deleted.



You can use the schedule as an automatic screensaver (see p. 70)

- ▶ Mark the *Eppendorf* node. Press the *Schedule* softkey.

The *Mastercycler Schedule* window appears.

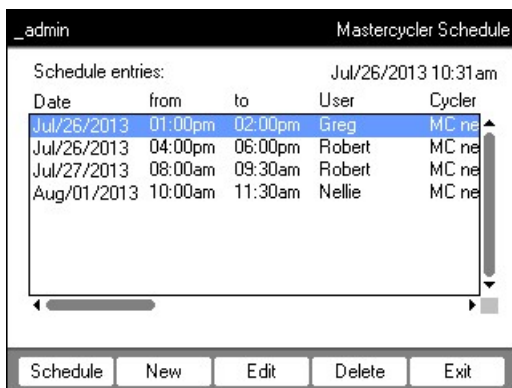

*Schedule*

Display the schedule.

*New*

Create a new schedule entry.

*Edit*

Change the schedule entry for the logged-in user.

*Delete*

Delete the schedule entry for the logged-in user.

*Exit*

Close the window.



### 5.6.1 Editing a schedule entry

The following window appears if you choose to display, create or change a schedule entry:

The screenshot shows a dialog box titled "\_admin New Schedule Entry". It has several input fields: "Month" (07), "Day" (26), "Year" (2013), "Begin:" (06:00 PM), and "End:" (07:00 PM). Below these are two dropdown menus: "User" (Greg) and "Cyclers" (MC nexus gradie). There is also a "Comment" text field which is currently empty. At the bottom of the dialog are "OK" and "Abort" buttons.

1. Complete the fields as follows.

*Day, Month, Year*

Date of the reservation.

*Begin:*

Start of the reservation.

*End:*

End of the reservation.

*User:*

Name of the respective user. Only users that have been set up can be selected.

*Cyclers*

Reserved device.

*Comment*

Optional: comment for the reservation.

2. Press the *OK* softkey.

The schedule entry appears in the list in the *Mastercycler Schedule* window.

## 5.6.2 Displaying the schedule

You can access the schedule from the *Mastercycler Schedule* and *User Login* windows.

**i** You can use the schedule as an automatic screensaver (see p. 70)

1. In the *Mastercycler Schedule* or *User Login* windows, press the *Schedule* softkey.  
 The schedule is displayed on a day-to-day basis.



Time	User	Cycler
01:00pm -	Greg	MC nexus gradient
02:00pm		
04:00pm -	Robert	MC nexus GX2e
06:00pm		left Block 64
06:00pm -	Greg	MC nexus gradient
07:00pm		

**i** Only days that have been activated by the administrator are displayed in the schedule(see p. 70).

2. Scroll to the left or right with the arrow keys to view the entries for other days.
3. Press the *Exit* softkey to exit the schedule.

## 5.7 Using the power save mode

You can use the power save mode to reduce power consumption when the device is in idle mode.

-  The Mastercycler nexus eco automatically switches to power saving mode if the thermoblock and heated lid have not been tempered.
-  The administrator can define that the Mastercycler nexus will automatically switch to the power saving mode (see p. 70).

### Prerequisites

- No program and no temperature control is active.
- The program editor is not open.
- No error message is displayed.

### Switching on the power save mode



- ▶ Press the standby key.  
The device switches to power save mode.
  - The display is switched off.
  - The USB ports are switched off.
  - The fan is switched off.
  - The status lamp flashes green at long intervals.

### Exiting the power save mode



- ▶ Press the standby key.  
The device leaves the power save mode.
  - The display is switched on.
  - The USB ports are switched on.

DOMINIQUE DUTSCHER SAS

## 6 Programming

### 6.1 Overview of the program editor

The graphic program editor can be used to view and change existing programs.

#### 6.1.1 Opening the program editor

1. Mark the desired program in the navigation tree or create a new program.
2. Press the *Edit* softkey.  
 The program editor is displayed.

#### 6.1.2 Structure of the program editor

A program consists of a program header and up to 99 program steps that are executed by the cycler one after the other. Use the program editor to create and adjust programs.

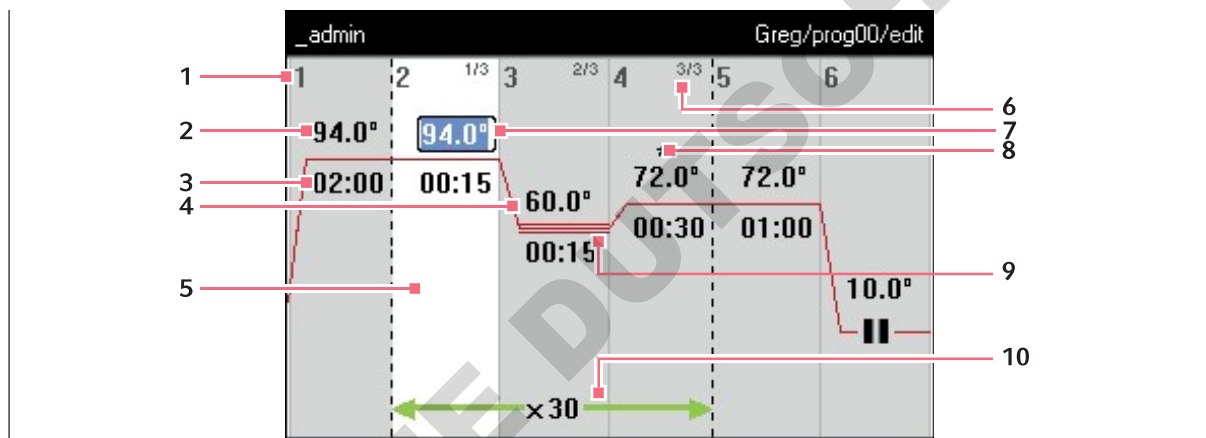

**1 Number of the program step**

**2 Block temperature [°C]**

The thermoblock is heated or cooled in the relevant step at this temperature.

**3 Holding time [mm:ss]**

The set block temperature is maintained for this time.

**4 Average temperature for gradient steps**

When using gradient steps, increasing temperatures are generated across the columns of the thermoblock from left to right. The average temperature is displayed here.

**5 Program step highlighted marking**

The selected program step is highlighted in blue. New program steps are inserted before the marked step.

**6 Step number within the cycle**

The step number within a cycle and the total number of steps in the cycle are displayed on the top right. Example: 2/3: second step of a 3-step cycle (3 StepCyc).

**7 Active input field**

Numerical keys are used to make entries.

**8 Extended program step**

Program steps are marked with a star \* if they have a temperature or holding time increment or a reduced heating or cooling rate.

**9 Marking of gradient steps**

Gradient steps are indicated by three horizontal lines.

**10 Number of cycles**

The number of cycles indicates how often the program steps indicated by the green horizontal arrow are to be carried out.

## 6.2 Making general settings

Each Mastercycler nexus program has a program header where you define the block temperature control mode and the behavior of the heated lid. These settings are valid for the entire program.

### 6.2.1 Opening the header

1. Open the program editor (see *Opening the program editor on p. 49*).

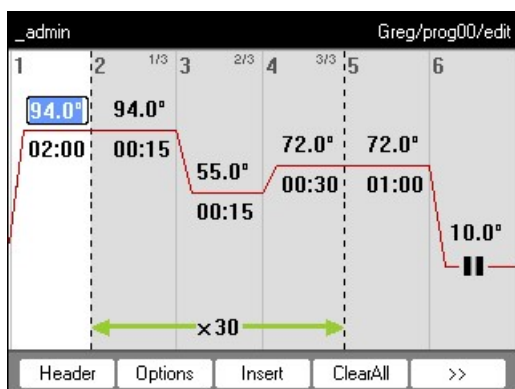

2. Press the *Header* softkey.

The header settings are displayed.

### 6.2.2 Editing header settings

<i>Lidtemp.</i>	Heated lid temperature (37°C to 110°C). The set lid temperature is maintained constant during the program run. If values below 37°C are entered, the heated lid remains switched off.
<i>TSP heated lid</i>	Preheat heated lid <ul style="list-style-type: none"> <li>• Switch TSP on and off.</li> </ul> If the <i>TSP heated lid</i> function is activated, the heated lid is heated up to the set temperature upon program start while the block temperature is maintained constant at 20°C. The program run starts once the heated lid temperature has been reached.

<i>switch off lid at low blocktemperature</i>	<p>Lid heater with automatic switch-off</p> <ul style="list-style-type: none"> <li>• Activated (default setting): the lid heater switches off if program steps have block temperatures of &lt; 15 °C.</li> <li>• Deactivated: the lid heater switches off after the end of the program. If the last command of the program is a hold step, the heated lid remains switched on until you press the <b>Enter</b> key.</li> </ul> <p><b>Note:</b> This option is useful if you have inserted a hold step as the last program step in order to automatically cool the samples after the PCR.</p>
<i>Temp. mode</i>	<p>Block temperature control mode</p> <ul style="list-style-type: none"> <li>• <i>fast</i>: Use this setting for Fast PCR, for low reaction volumes (&lt; 20 µL) and for templates with a low G/C content. With this setting you achieve the shortest program run times.</li> <li>• <i>standard</i>: block temperature control mode for standard applications. Use this setting for sample volumes between 20 µL and 50 µL or if the <i>fast</i> setting only results in a weak amplification. The program run times are slightly longer than with the <i>fast</i> setting.</li> <li>• <i>safe</i>: block temperature control mode for complex template and large reaction volumes. Use this setting for sample volumes of 50 µL or more or to amplify templates with a high G+C content. The program run times are slightly longer than with the <i>standard</i> setting.</li> </ul>
<i>Simulate Mastercycler gradient</i>	<p>Simulate the temperature control behavior of the Mastercycler or Mastercycler gradient. This enables you to transfer programs from these cycler models to the Mastercycler nexus without making any adjustments (see <i>Transferring programs from an older Mastercycler model on p. 82</i>).</p> <p>If this option is deactivated, programs created for the Mastercycler will need to be adapted for the Mastercycler nexus because of different temperature behavior. This may influence the PCR results.</p>

## 6.3 Editing programs

You can add, edit or delete steps in new (see p. 42) or copied (see p. 43) programs.

### 6.3.1 Inserting a program step

1. Open the program editor (see *Opening the program editor on p. 49*).
2. Mark the program step with the arrow keys **in front of which** you would like to insert a new program step.

The marked program step is highlighted in blue.

3. Press the *Insert* softkey.

A list appears containing the available program steps.

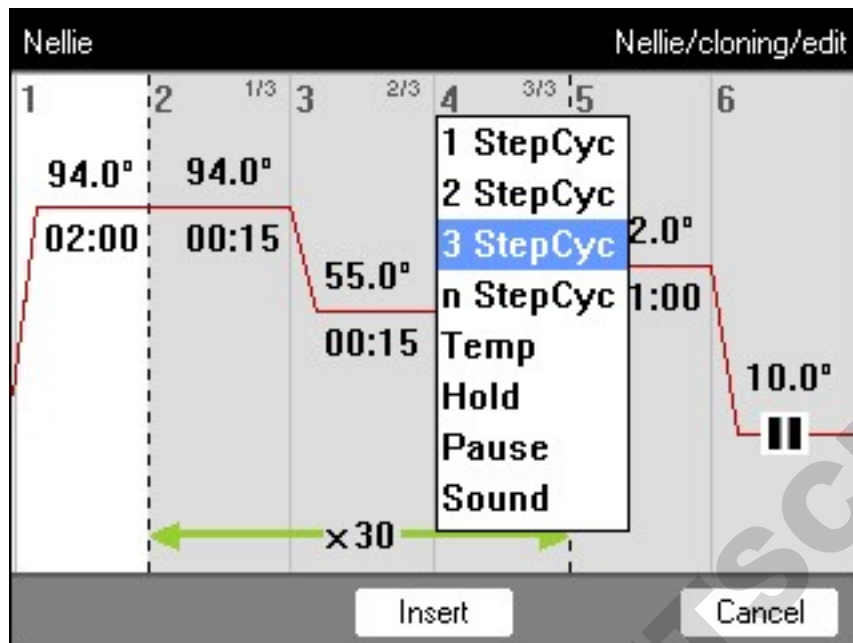

4. Select the desired program step with the arrow keys.

The following program steps are available:

<i>1 StepCyc to 3 StepCyc</i>	Cycle program step with 1 to 3 temperature steps with an adjustable number of repetitions (1 to 99). With cycle program steps you can increase or reduce the block temperatures and holding times by a preset value after each cycle .
<i>n StepCyc</i>	Cycle program step with an adjustable number of temperature steps. After this program step has been selected and confirmed with <b>enter</b> , a dialog window for the following entries is displayed. <ul style="list-style-type: none"> <li>• <i>Steps per Cycle</i>: Number of temperature steps per cycle (1 to 40)</li> <li>• <i>Number of Cycles</i>: Number of cycles (1 to 99). If you have inserted a cycle with more than 6 steps, use the <b>←</b> and <b>→</b> arrow keys to view the steps that are not displayed.</li> </ul>
<i>Temp</i>	Individual temperature step with adjustable block temperature and holding time.
<i>Hold</i>	Temperature step with adjustable block temperature and indefinite holding time. The set temperature is maintained until the user presses the <b>enter</b> key. A corresponding prompt is displayed in the status view and signaled by orange flashing of the status lamp.
<i>Sound</i>	This program step emits an acoustic signal.
<i>Pause</i>	As <i>Hold</i> . The block temperature remains set to the value of the previous temperature step.



5. Press the *Insert* softkey.

The program step is inserted with standard parameters.



You can now insert additional program steps or edit the parameters of the program steps.

### 6.3.2 Editing parameters

1. Mark the desired program step with the arrow keys.

The marked program step is highlighted in blue.

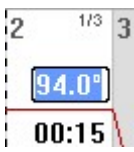
You can change the temperature, holding time and number of cycles directly in this view.

	<b>Temperature</b>	Adjustable from 4.0°C to 99.0°C (in 0.1°C increments)
	<b>Dwell time</b>	Adjustable from 000:00 to 999:59 (mmm:ss) in 1-second steps
	<b>Number of cycles</b>	Adjustable from 1 to 99

2. Press the **enter** key to accept the changes.

DOMINIQUE DUTSCHER SAS

### Extended options

3. Press the *Options* softkey.

The extended parameter settings for the marked program step are displayed.

<i>Temp</i>	Temperature of the program step
<i>Temp Inc./Dec.</i>	Temperature change from one cycle to the next Adjustable from $-10.0^{\circ}\text{C}$ to $+10.0^{\circ}\text{C}$ in $0.1^{\circ}\text{C}$ increments. You can switch between positive and negative values by pressing the +/- softkey.
<i>Gradient</i>	Temperature gradient in the thermoblock, displayed as columns Detailed information on how to program a gradient step can be found in a separate section (see p. 54).
<i>Time</i>	Holding time for the program step
<i>Time Inc./Dec.</i>	Holding time change from one cycle to the next Adjustable from $-01:00$ to $+01:00$ in 1 s increments. You can switch between positive and negative values by pressing the +/- softkey.
<i>Ramp</i>	Temperature control speed of the thermoblock Aluminum thermoblock: adjustable from $0.1^{\circ}\text{C/s}$ to $1.5^{\circ}\text{C/s}$ . Alternatively, <i>max.</i> can be set. If you select <i>max.</i> , the maximum heating and cooling speeds specified in the Technical Data will be used.

4. Press the *OK* softkey to accept the settings.  
The program view appears.
5. Press the >> softkey. Press the *Save* softkey.  
The changes are saved.
6. Press the *Exit* softkey to exit the editor.

#### 6.3.3 Create gradient step

You can use a gradient step to optimize the specificity and yield in PCR reactions. A temperature gradient increasing from the left to the right side of the block is generated during the holding time. The ramp rates before and after the gradient step are constant across the entire thermoblock.



Details about the maximum gradient spread can be found in the product description (Tab. on p. 22).

The gradient function is only available to the following devices:

- Mastercycler nexus gradient
- Mastercycler nexus gradient eco
- Mastercycler nexus GX2 (Gradient function only for thermoblock with 64 wells)
- Mastercycler nexus GX2e (Gradient function only for thermoblock with 64 wells)

Proceed as follows to define a gradient step in a PCR program:

1. Mark the temperature control step in which you would like to define the gradient.
2. Press the *Options* softkey.

The options for the selected temperature control step are displayed.

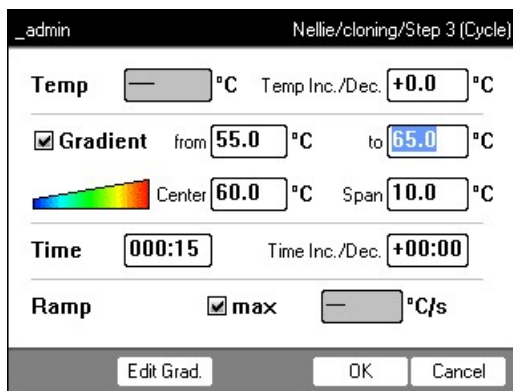

3. Select the *Gradient* checkbox.
4. Define the gradient temperatures.

The gradient temperatures can be defined in two ways:

- By entering limit temperatures
  - *from*: lower limit temperature (left side of block)
  - *to*: lower limit temperature (left side of block)
- By entering the center temperature and the temperature span
  - *Center*: center temperature (center of block)
  - *Span*: temperature span (gradient range)

5. Optional: Press the *Edit Grad.* softkey to display the resulting temperatures in block columns.

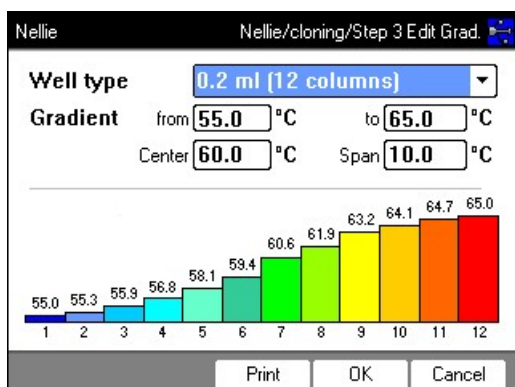

<i>Well type</i>	Select the tube type: <ul style="list-style-type: none"> <li>• <i>0.2 ml (12 columns)</i>: standard PCR tubes and 96-well plates</li> <li>• <i>0.5 ml (11 columns)</i>: 0.5 mL PCR tubes</li> <li>• <i>0.2 ml GX2 (8 columns)</i>: 0.2 mL PCR tubes</li> <li>• <i>0.5 ml GX2 (7 columns)</i>: 0.5 mL PCR tubes</li> </ul>
<i>Gradient</i>	Gradient temperature

6. Press the *OK* softkey to accept the settings and close the window.

The gradient step is symbolized in the program editor by three horizontal lines.

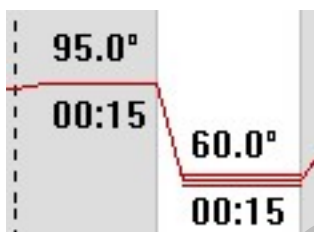

### 6.3.4 Deleting program steps

1. Mark the desired program step with the arrow keys. To delete all program steps, press the *ClearAll* softkey.
2. Press the **del** key.
3. Press the *Save* softkey to save the change.

Press the *Exit* softkey to exit the editor.

### 6.3.5 Exporting a program as a PDF or text file

You can export a program to an external storage medium as a file for archiving.

1. Connect a storage medium (see p. 40).
2. Press the **>>** softkey.
3. Press the *Export* softkey.
4. Select the file format (text or PDF). Press the *OK* softkey.  
The program is saved to the external storage medium as a file.

### 6.3.6 Saving a program and exiting the editor

1. Press the **>>** softkey.
2. Press the *Save* softkey.  
The program is saved.
3. Press the *Exit* softkey.  
The navigation tree is displayed. You can now start the program (see *Starting a program on p. 61*).

DOMINIQUE DUTSCHER SAS

## 6.4 Program templates

The following table provides an overview of the program templates. The program templates can be used to create new programs.

Program template	Description
<i>none</i>	Empty template with standard header settings.
<i>2-step PCR</i>	Standard PCR program with two temperatures per cycle and 30 cycles, one hold step at the end.
<i>3-step PCR</i>	Standard PCR program with three temperatures per cycle and 30 cycles, one hold step at the end.
<i>Cycle sequencing</i>	Standard program for cycle sequencing with ramp rates of 1 °C/s.
<i>Fast PCR</i>	3-step PCR with short hold times and temperature mode <i>fast</i> .
<i>Gradient PCR</i>	PCR program with a temperature gradient in the annealing step of each cycle.
<i>Hot start PCR manual</i>	PCR program with thermoblock preheating at 95 °C. Start the following PCR run using the <b>start</b> key.
<i>Hot start PCR</i>	10 min enzyme activation at 95 °C and 3-step PCR.
<i>Incubation</i>	IsoTherm incubation.
<i>Large volume PCR</i>	3-step PCR in <i>safe</i> temperature mode.
<i>Long range PCR</i>	3-step PCR with 10 min elongation and a time interval of +10 s per cycle.
<i>Low volume PCR</i>	3-step PCR in <i>fast</i> temperature mode.
<i>Mastercycler 533x</i>	3-step PCR with simulation of the temperature control behavior of the Mastercycler gradient 5331.
<i>Nested cycles</i>	Program in which 3 cycles, with 3 temperatures each, are summarized in a 9-StepCycle, e.g., for TAIL PCR.
<i>Reduced Ramping</i>	3-step PCR with ramp rates of 1 °C/s.
<i>Reverse Transcription</i>	Incubation for reverse transcription and enzyme activation.
<i>RT-PCR</i>	Program for 1-step RT-PCR with series incubation for reverse transcription.
<i>Touchdown PCR</i>	PCR program with falling annealing temperature. During the first 16 cycles, the annealing temperature will be decreased by 1 °C per cycle.

## 7 PCR run

### 7.1 Loading the thermoblock

#### 7.1.1 Selecting the sample tubes

##### 7.1.1.1 Approved sample tubes for devices with a thermoblock with 96 wells

The thermoblock can be loaded with the following sample tubes:

- 0.1 mL PCR tubes
- 0.2 mL PCR tubes
- 0.5 mL PCR tubes (only for aluminum thermoblock)
- PCR tube strips (0.1 mL or 0.2 mL)
- 96-well PCR plates
- segments of separable 96-well PCR plates

##### 7.1.1.2 Approved sample tubes for devices with 64+32-well thermoblocks

The thermoblock can be loaded with the following sample tubes:

- 0.1 mL PCR tubes
- 0.2 mL PCR tubes
- 0.5 mL PCR tubes
- PCR tube strips (0.1 mL or 0.2 mL)
- 64-well and 32-well PCR plates
- segments of separable 96-well PCR plates

##### 7.1.1.3 Compatible types of PCR plates

The following types of PCR plates are compatible.

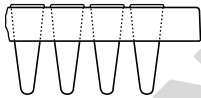
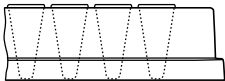
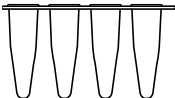
Semi-skirted PCR plate	Skirted PCR plate	Non-skirted/unskirted PCR plate
		
PCR plate with a semi skirt.	PCR plate with full skirt.	PCR plate without a skirt.

##### 7.1.1.4 Requirements

The sample tubes must meet the following requirements:

- Temperature resistance of 120 °C min.
- Accurate fit in the thermoblock

### 7.1.1.5 Maximum volumes

The sample volumes may vary depending on which type of sample tube is used.

#### For devices with an aluminum thermoblock

- PCR plates and 0.1 mL or 0.2 mL PCR tubes: Max. 70 µL
- 0.5 mL PCR tubes: Max. 100 µL

### 7.1.2 Inserting the sample tubes



#### **WARNING! Biohazard due to sample material directly in the thermoblock.**

- ▶ Do not fill sample material directly into the thermoblock.
- ▶ Only use reaction vessels, plates and lids that meet the requirements specified in the operating manual.



#### **WARNING! Biohazard when tempering with the heated lid open.**

When tempering with an open heated lid, the lids of the reaction vessels can spring open. This will release sample material.

- ▶ Only temper with a closed heated lid.

Observe the following information when loading the thermoblock with tubes

- ▶ Place the tubes in the center of the thermoblock and ensure that they are positioned symmetrically towards the center. This applies for individual tubes, tube strips and segments of divisible PCR plates.
- ▶ Load 96-well thermoblocks with at least 5 tubes. If you have fewer reaction batches, add some empty tubes to ensure that the thermoblock is loaded with a minimum of 5 tubes.
- ▶ Load 64+32-well thermoblocks with at least 2 tubes. If you have fewer reaction batches, add some empty tubes to ensure that the thermoblock is loaded with a minimum of 2 tubes.



Very soft PCR tubes may become deformed at high temperatures. To prevent deformation:

- Increase the number of empty sample tubes in the thermoblock.
- Reduce the temperature of the heated lid (see p. 50).
- Use original Eppendorf PCR consumables. Eppendorf PCR consumables are a perfect match for the device.



## 7.2 Starting a program



If the *PIN* function is activated, you can only start programs that are saved below your user node (see p. 67).

### Prerequisites

- Thermoblock loaded (see p. 59)
- Heated lid closed (see p. 34)

1. Mark the program in the navigation tree with the arrow keys or open it in the editor.
2. Press the **start** key.

If multiple cyclers are available, the *Cycler Selection* window appears.

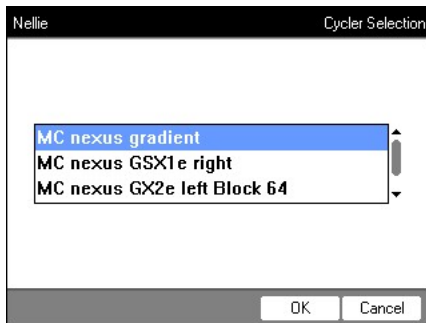

3. Mark the desired cycler.
4. Press the *OK* softkey.

The program is started and the status view appears.

### 7.2.1 Status view

The status view is automatically displayed immediately after a program is started. It shows the progress of and information on a running program. The currently active step is displayed as a flashing line.

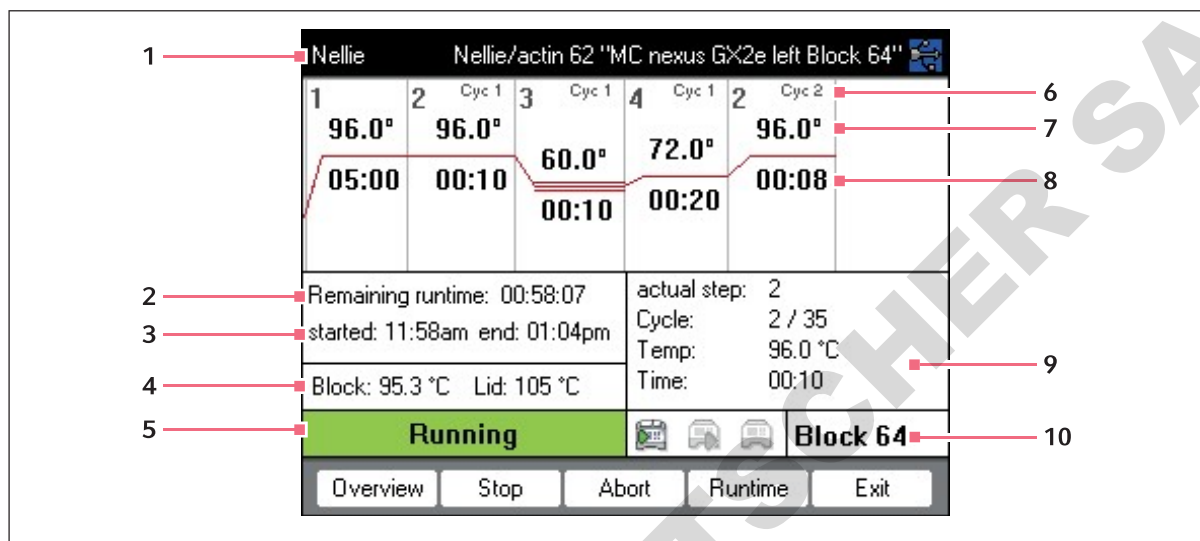

- |                                     |   |
|-------------------------------------|---|
| 1 User, program name and cycler     | 6 Cycle number                            |
| 2 Remaining run time                | 7 Block target temperature                |
| 3 Start and end time of the program | 8 Remaining holding time                  |
| 4 Block and heated lid temperature  | 9 Information on the current program step |
| 5 Device status                     | 10 Specification of the selected cycler   |



If you have activated the *TSP* function in the program header (see p. 50), the heated lid is first brought to the correct temperature before the program run starts. This process is indicated in the status view by the message *TSP heated lid*.

You can exit the status view and return to the navigation tree at any time by pressing the *Exit* softkey, e.g. to edit another program or start a program on a different cycler. Use the left/right arrow key to access the status view of other connected cyclers. The program that was already started is not interrupted as a result.

### 7.2.1.1 Displaying the status view

Proceed as follows:

1. Mark the cyclers in the navigation tree.
2. Press the *Status* softkey.

The status of the cyclers is shown with an icon:

-  Idle
-  Running
-  Paused
-  Fault

### 7.2.2 Common status view for devices with a thermoblock with 64+32 wells

The common status view shows the progress and most important information on the running programs of both thermoblocks.

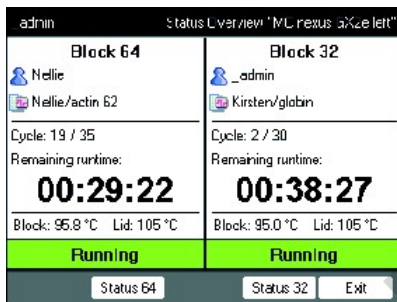

You can display the status views of the individual programs via the *Block 64* and *Block 32* softkeys.

The status views of the individual programs can be accessed via the up/down arrow keys.

Use the right/left arrow keys to call up the common status views of other connected cyclers.

To open the common status view, proceed as follows:

1. Mark the cyclers in the navigation tree.
2. Press the *Overview* softkey.



The common status view can also be opened via the *Overview* softkey in the status view of the respective program.

## 7.3 Interrupting or stopping a program

### 7.3.1 Interrupting a program

1. Open status view (see *Starting a program on p. 61*).
2. Press the **stop** key.

*Paused* is displayed in the status view.

### 7.3.2 Resuming a program

1. If the heated lid is open: close the heated lid.
2. Press the *Resume* softkey.

*running* appears in the status view, and the program run continues.

### 7.3.3 Stopping a program

- ▶ Press the *Abort* softkey.

The *Idle* status is displayed. The program has been aborted and cannot be continued.





A hold step at the end of a PCR program is completed via the **enter** key. In the common status view, you can end the PCR program out of a hold step via the *End 64* or *End 32* softkeys.

## 7.4 Displaying the most recently run programs

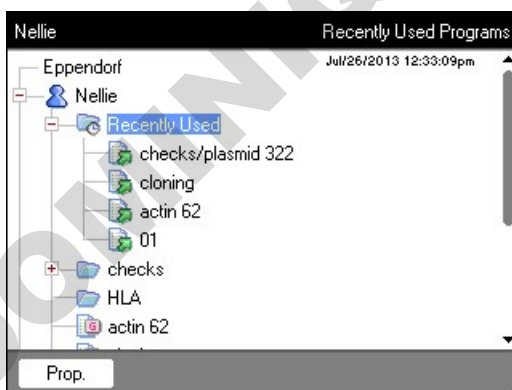

The device can display a list of the 5 most recently run programs.

If the *PIN* function is switched on and a user is logged in, the  *Recently Used* node is positioned in the user node.

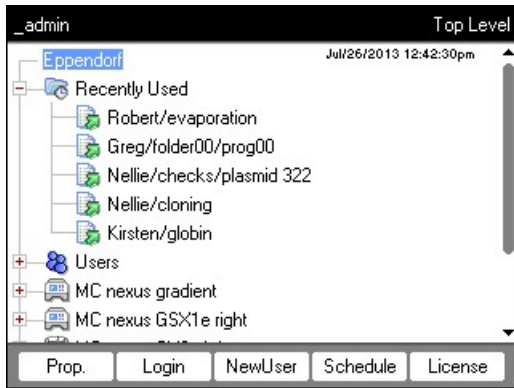

If the *PIN* function is switched off or the administrator is logged in, the  *Recently Used* node is located below the  *Eppendorf* node.



 If no user is logged in, the  *Recently Used* node is not available.

The following functions are available:

Key: <b>start</b>	Start the last run program.
Softkey: <i>Prop.</i>	Display the properties of the last run program.
Softkey: <i>Edit</i>	Edit the last run program.
Softkey: <i>Copy</i>	Copy the last run program.
Softkey: <i>Export</i>	Export the last run program.

DOMINIQUE DUTSCHER SAS

## 8 System management

### 8.1 Administrator functions

The Mastercycler nexus software differentiates between default users and the administrator. All users and the administrator need a PIN to log into the device. Users can only make changes to their own accounts. The administrator has write access to all areas. If you deactivate the PIN function, all users automatically have administrator rights and can make changes to all user accounts (see p. 70).

The access rights differ as follows:

Procedure	Default users	Administrator
Copying programs	From each user node to own user node	From each user node to each user node
Creating, deleting, editing and starting programs	Only programs below their own user node	All programs
Managing user accounts and generating PINs	Only change own user name and PIN	Create, change, delete user accounts. Change the PIN for each user.
Making system settings	None	All
Performing the self test, verification and adjustment	Self test and verification only	Self test, verification and adjustment
Performing backups, restores and software synchronizations	Only backups	All

### 8.2 Managing user accounts



- A user name can only be assigned once.
- The administrator uses the set user name `_admin`.

#### 8.2.1 Creating a user account

Prerequisites

If the PIN function is activated: logged in as an administrator

You can set up a user account for each user:

1. In the navigation tree, mark the *Eppendorf* node (at the top).

2. Press the *NewUser* softkey.

The *New User* window appears.

3. Enter the name and PIN of the new user. Re-enter the PIN in the *Confirmation:* field.
4. Optionally enter the user's e-mail address in the *E-mail address:* field. To activate e-mail notifications, check the *Enable e-mail notification* checkbox.
5. Press the *OK* softkey.  
The new user account is created. A new user node with this user name is created in the navigation tree. The user can now log in with his PIN.

### 8.2.2 Editing a user account

If you have the appropriate user or administrator rights, you can change the following data of existing user accounts:

- PIN
- E-mail address
- Comment

1. Mark the user node in the navigation tree. Press the *Prop.* softkey.  
The *User Properties* window appears.
2. Change the settings for the user account. Press the *OK* softkey.

### 8.2.3 Deleting a user account

You must be logged in as an administrator to be able to delete user accounts.



Deleting a user account will delete the respective user node including all folders and programs it contains. Deleting a user account is a permanent change and cannot be undone.

1. Mark the user node. Press the **del** key.  
A query appears whether you really want to delete the user account.
2. Press the *OK* softkey.  
The user account is deleted.



## 8.2.4 Changing the administrator PIN

If you are logged on as an administrator, you can change the administrator PIN at any time.



**NOTICE! Data loss due to unauthorized use of the administrator password.**

The administrator password protects the device software from unwanted access.

- ▶ Make a note of the administrator password.
- ▶ Store the administrator password in a secure location.
- ▶ Only provide the administrator password to individuals who work with the system configuration.
- ▶ Please contact Eppendorf SE if you have any problems with the administrator password.

1. Switch on the Mastercycler nexus and log in as the administrator.
2. Mark the *System* node. Press the *Prop.* softkey.  
The *System Properties* window appears.
3. Enter the new administrator PIN using the numeric keys.  
If you have entered the PIN incorrectly, delete it with the **del** key and re-enter the PIN.
4. Re-enter the new PIN in the *Confirmation:* field to confirm.
5. Press the *OK* softkey.  
The new administrator PIN is immediately valid.

### 8.3 System settings

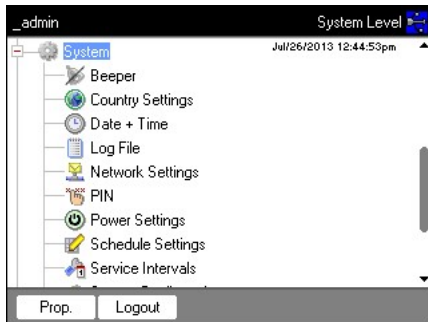

- ▶ To change the system settings, open the *System* node.

<i>Beeper</i> : activate or deactivate signal tones	<ul style="list-style-type: none"> <li>▶ Activate or deactivate the <i>Beeper</i> node. When the function is activated, the key-press and error message signal tones are switched on. When the function is deactivated, only the error message signal tones are switched on.</li> </ul>
<i>Country Settings</i> : change country settings	<p>The country settings are identified by the international dialing code (e.g., "001" for the U.S.). In the country settings, you can define the language setting and the date and time display (12 or 24-hour format).</p> <ol style="list-style-type: none"> <li>1. Mark the <i>Country Settings</i> node. Press the <i>Set</i> softkey.</li> <li>2. Select the desired settings. Press the <i>OK</i> softkey. The device restarts.</li> </ol>
<i>Date + Time</i> : set date and time	<ol style="list-style-type: none"> <li>1. Mark the <i>Date + Time</i> node. Press the <i>Set</i> softkey.</li> <li>2. Set the date and time . Press the <i>OK</i> softkey.</li> </ol>
<i>Log File</i> : export log file	<ul style="list-style-type: none"> <li>▶ Mark the <i>Log File</i> node. Press the <i>Export</i> softkey. The log file is written to the storage medium.</li> <li>▶ Optional: to display the log file, mark the <i>Log File</i> node. Press the <i>Show</i> softkey.</li> </ul>
<i>Network Settings</i> : change network settings	<p>Set up a network connection (see <i>Network connection on p. 83</i>).</p>
<i>PIN</i> : activate or deactivate the PIN	<ul style="list-style-type: none"> <li>▶ To activate the <i>PIN</i> function (user management), press the <i>Select</i> softkey, or press the <i>Unselect</i> softkey to deactivate it. The device restarts.</li> </ul>

<p><i>Power Settings</i>: configure the automatic power saving mode</p>	<p>The <i>Power Settings</i> node can be used to define when the device should automatically switch to power saving mode.</p> <ol style="list-style-type: none"> <li>1. Mark the <i>Power Settings</i> node. Press the <i>Set</i> softkey.</li> <li>2. To activate the automatic power saving mode, select the <i>Enable automatic standby</i> checkbox.</li> <li>3. In the <i>Enter standby mode after (hh:mm)</i> field, set the time after which the device should automatically switch to power saving mode. Press the <i>OK</i> softkey.</li> </ol>
<p><i>Schedule Settings</i>: make schedule settings</p>	<p>The <i>Schedule Settings</i> can be used to configure the schedule display and selection options.</p> <ul style="list-style-type: none"> <li>▶ Mark the <i>Schedule Settings</i> node. Press the <i>Set</i> softkey.       <ul style="list-style-type: none"> <li>• To use the schedule as a screensaver, select the <i>Enable Screensaver</i> checkbox. In the <i>Wait [s]</i> field, set the time after which the screensaver should be activated.</li> <li>• To select the days of the week to be displayed in the schedule, activate the corresponding checkboxes for <i>In schedule day view the following weekdays are displayed</i>.</li> <li>• To select the device types to be displayed in the schedule, activate the corresponding checkboxes for <i>In the schedule editor the following cyclers are enabled</i>.</li> </ul> </li> <li>▶ Press the <i>OK</i> softkey.</li> </ul>

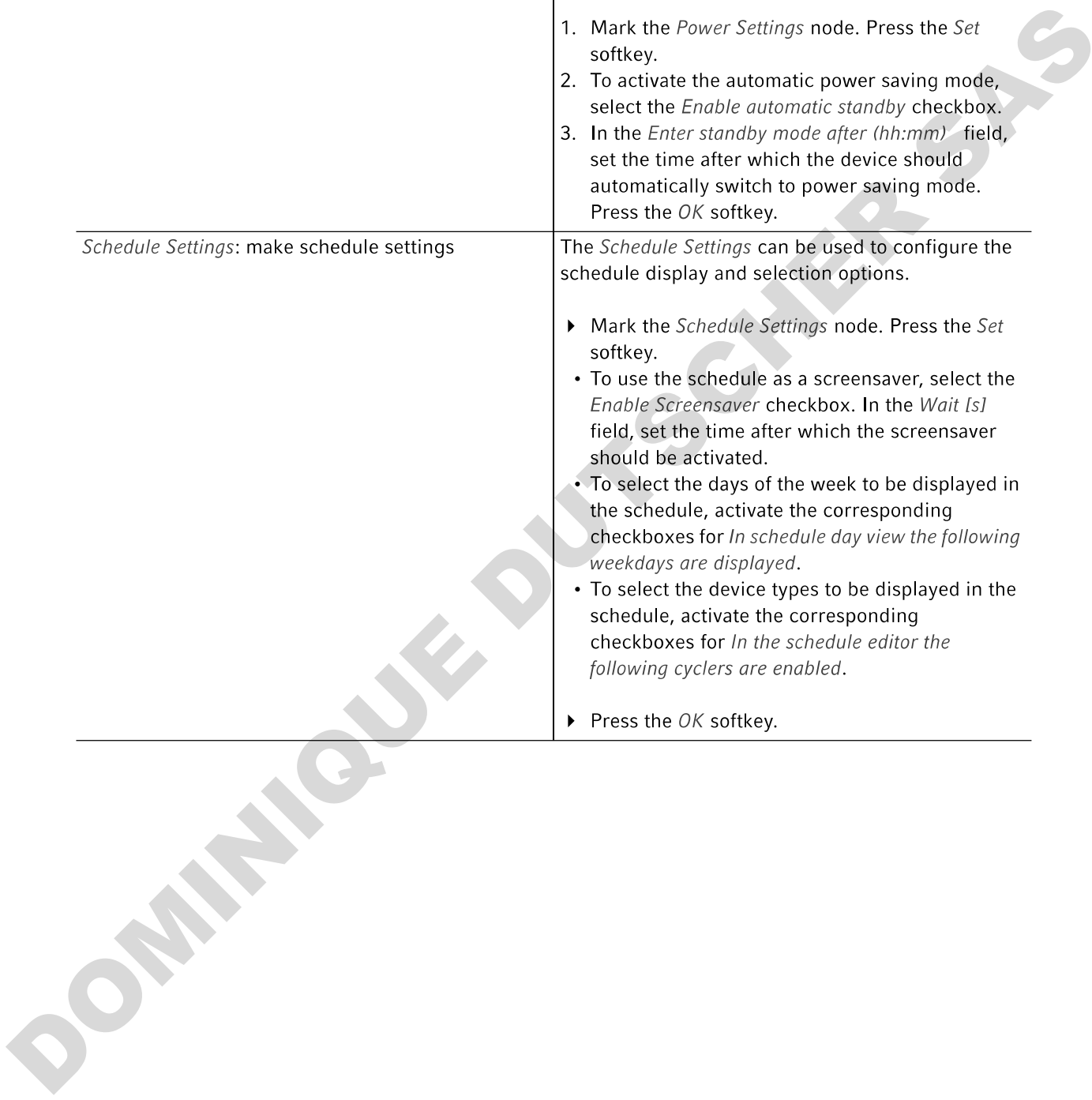

*Service Intervals*: configure the temperature verification and self-test intervals

The *Service Intervals* node can be used to define intervals for a regular temperature verification or a self test.

- ▶ Mark the *Service Intervals* node. Press the Verification or Self-test softkey. The intervals can be defined in the following display.
  - Specification of months (1 – max. 24)
  - Specification of programs run (1 – max. 2000)

The following information is displayed for each cyler:

- the programs run since the last verification or self test
- the date of the next check

This information can also be found in the *Block* cyler system functions (see p. 75).

You will receive an information message before the defined intervals expire. The information message contains details about the remaining days or program runs before the interval expires. If e-mail dispatch is activated (see p. 85), the administrator will receive a corresponding message.

When the intervals expire, a temperature verification and/or a self test must be carried out. Alternatively, you can deactivate the interval setting.

*System Configuration*: configure device-specific information on ramp and gradient

Changes under *System Configuration* are only required if you operate different variants of master and eco devices together.

- ▶ Mark the *System Configuration* node. Press the *Set* softkey.
- ▶ Set the ramp specifications.
  - For devices with an aluminum thermoblock, select Mastercycler nexus. Adjustable value range: 0.1 to 1.5 °C/s or *max.*.
- ▶ Set the gradient range specifications.
  - For devices with the 96-well thermoblock with a gradient function, select 20 °C. If "Off" is selected, no gradients can be programmed and the corresponding programs cannot be started.
  - For devices with the 64+32-well thermoblock with a gradient function, select 12 °C. If "Off" is selected, no gradients can be programmed and the corresponding programs cannot be started.
  - The *Show well types* checkboxes can be used to define which well types are displayed under *Edit Grad.* (see p. 54).

<p><i>User Log File</i>: display or export user data</p>	<p>The <i>User Log File</i> node can be used to display or export all actions performed as a log file. You can display or export the following data:</p> <ul style="list-style-type: none"> <li>• login and logout procedures</li> <li>• changes to and interventions in running programs</li> <li>• software version update</li> <li>• definition and deactivation of service intervals</li> </ul> <p>▶ Mark the <i>User Log File</i> node. Press the <i>Show</i> softkey.</p> <p>In the next window, you can print or export the log file.</p> <ul style="list-style-type: none"> <li>▶ To export the log file, press the <i>Export</i> softkey.</li> <li>▶ To print the log file, press the <i>Print</i> softkey.</li> </ul>
--	---

## 8.4 Cyclers functions

The  cycler nodes enable you to view and adjust the status of the thermoblock and the heated lid and access the protocols of the last 20 programs.

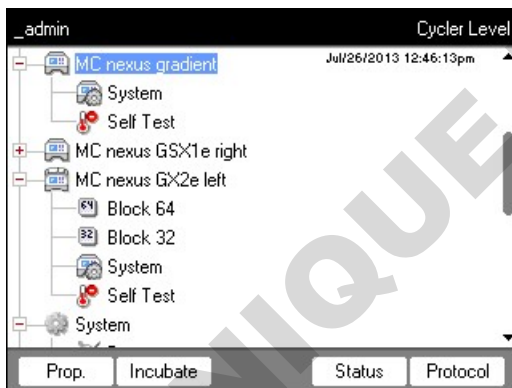

The softkeys have the following functions:

<p><i>Prop.</i></p>	<ul style="list-style-type: none"> <li>• Change the name of the cycler node. The name must not contain any special characters.</li> <li>• Display the installed firmware version</li> <li>• Display the last logged-in user</li> <li>• Display the last run program</li> </ul>
---------------------	--

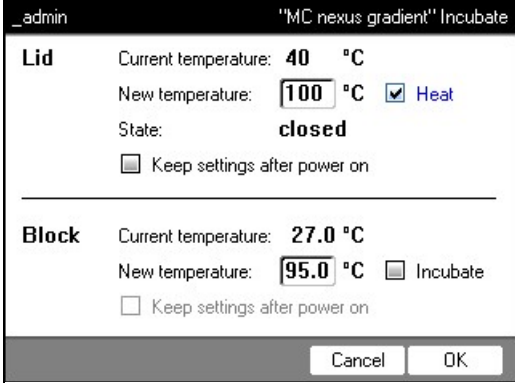
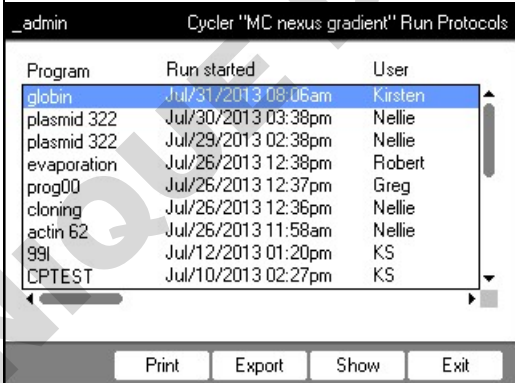
<p><i>Incubate</i></p>	<p>Display and change the current temperature of the heated lid and the thermoblock.</p>  <ul style="list-style-type: none"> <li>• <i>Current temperature</i>: Display the current temperature</li> <li>• <i>New temperature</i>: Set the target temperature</li> <li>• <i>Heat/Incubate</i>: Control the temperature of the heated lid/thermoblock</li> <li>• <i>Keep settings after power on</i>: Automatically keep the current temperature control setting when the cyclor is idle. This setting will remain unchanged even after a cyclor restart. It can only be changed by an administrator.</li> </ul>
<p><i>Status</i></p>	<ul style="list-style-type: none"> <li>• Display the cyclor operating status</li> <li>• Display the temperatures of the thermoblock and the heated lid</li> <li>• Display the remaining run time for the program</li> <li>• Stop the program</li> </ul>
<p><i>Protocol</i></p>	<p>Protocols of the last 20 program runs:</p>  <ul style="list-style-type: none"> <li>▶ Select the protocol via the arrow keys.</li> <li>• <i>Print</i> softkey: Print the protocol</li> <li>• <i>Export</i> softkey: Copy the protocol to a storage medium</li> <li>• <i>Show</i> softkey: Display the protocol</li> </ul>



The following applies to devices with a thermoblock with 64+32 wells:  
 The Cycle functions comprise the *Properties*, *Overview*, *Status 64* and *Status 32* softkeys.  
 The *Incubate* and *Protocols* softkeys are located under the subnodes *Block 64* or *Block 32*.

### 8.4.1 Cyclers system functions

The *System* node contains the cycler system level with the following softkeys.

<i>Info</i>	<ul style="list-style-type: none"> <li>• Display the device name</li> <li>• Display the date of the last verification</li> <li>• Display the date of the last verification</li> <li>• Display the programs run (since the last verification)</li> <li>• Display the date of the last self test</li> <li>• Display the date of the next self test</li> <li>• Display the programs run (since the last self test)</li> <li>• Display the date of the last adjustment</li> </ul> <p>Details about the next verification or self test are only given if the settings have been made under <i>Service intervals</i> (see p. 70).</p>
<i>Restart</i>	Entry for maximum duration of interruption of voltage supply ( <i>mm:ss</i> ) after which a running program should be automatically restarted. The program is not restarted after a longer interruption.
<i>Sensors</i>	Display current sensor temperatures for the control loops of the thermoblock and the heated lid.
<i>Verification</i>	Verify temperature accuracy and temperature homogeneity of the thermoblock with the Eppendorf Temperature Verification System.
<i>Adjustment</i>	Adjust temperature accuracy and temperature homogeneity of the thermoblock with the Eppendorf Temperature Verification System. Can only be done by the administrator.



The Eppendorf Temperature Verification System is required for the *Verification* and *Adjustment* functions. For information on how to use this system, refer to the corresponding operating manual.

DOMINIQUE BIESCHLER SAS

### 8.4.2 Self test

The self test function allows you to perform a quick check regarding the following attributes of the thermoblock without requiring an external measurement system:

- Heating and cooling rates
- Proper functioning of the temperature control loops
- Temperature homogeneity in each of the three block zones and across the entire block

Test Results	Left	Center	Right
Heating/cooling rates	PASS	PASS	PASS
Temperature control	PASS	PASS	PASS
Temperature homogeneity	PASS	PASS	PASS
Overall temp. homogeneity	PASS		
TEST PASSED		Lid 85 °C Block 4.2 °C	
Start		Certificate Exit	

After a successful self test, a certificate can be generated in PDF format.

#### Conducting a self test



#### CAUTION! Risk of burns on the thermoblock, heated lid and reaction vessels.

The thermoblock, heated lid and reaction vessels reach temperatures of over 50 °C very quickly.

- ▶ Wait until the temperature of the thermoblock, heated lid and reaction vessels is below 30 °C.
- ▶ Then open the heated lid.

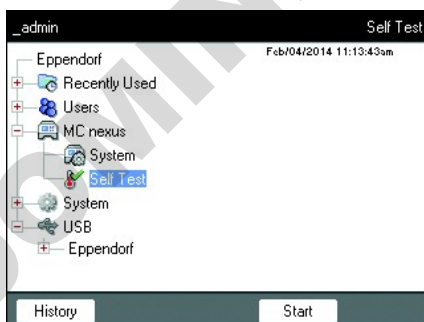

1. Load the thermoblock with an empty PCR plate.
2. Close the heated lid.
3. Select the device in the navigation tree.
4. Select the *Self Test* function.
5. Press the *Start* softkey.  
The *Test Results* window is displayed.



_admin "MC nexus" Cycler Self Test			
Test Results	Left	Center	Right
Heating/cooling rates	UNTESTED	UNTESTED	UNTESTED
Temperature control	UNTESTED	UNTESTED	UNTESTED
Temperature homogeneity	UNTESTED	UNTESTED	UNTESTED
Overall temp. homogeneity	UNTESTED		
Press "Start" to begin	Lid --- °C		Block --- °C
Start		Exit	

- Press the *Start* softkey.  
 The self test starts automatically. Information on the current test will be displayed.

**Test procedure**

_admin "MC nexus" Cycler Self Test			
Test Results	Left	Center	Right
Heating/cooling rates	PASS	PASS	PASS
Temperature control	Test in progress...		
Temperature homogeneity			
Overall temp. homogeneity			
Determining block temperature homogeneity.	Lid 105 °C		Block 74.8 °C
Abort			

<i>Left, Center, Right</i>	Left, center and right block zones according to the temperature control loops of the block.
<i>Heating/cooling rates</i>	Temperature control speed of the block during heating or cooling
<i>Temperature control</i>	Accuracy of the temperature control.
<i>Temperature homogeneity</i>	Temperature homogeneity in each individual control system
<i>Overall temp. homogeneity</i>	Temperature homogeneity throughout the entire block

The temperature homogeneity and the accuracy of the temperature control are determined at the block temperatures 4 °C, 35 °C, 55 °C, 75 °C and 95 °C after a holding time of 30 s.

The test result is displayed after 5 to 10 minutes.

### Displaying the results

- *PASS*: Partial tests passed.
- *FAIL*: Partial tests failed.

The self test is considered passed if all partial tests have been successfully completed.

_admin "MC nexus" Cycler Self Test			
Test Results	Left	Center	Right
Heating/cooling rates	PASS	PASS	PASS
Temperature control			FAIL
Temperature homogeneity			
Overall temp. homogeneity	FAIL		
TEST FAILED	Lid 105 °C Block 93.0 °C		
Start		Exit	



If the self test is not passed, this indicates that the block is aging, maladjusted or has a malfunction. Please contact the authorized service if this is the case.



Use the Eppendorf Temperature Verification System to verify and adjust the block's temperature accuracy.

### Creating a certificate

#### Prerequisites

The self test was passed in all partial tests, and the test result is displayed.

1. Connect a storage medium.
2. Press the *Certificate* softkey.

The certificate is copied to the storage medium as PDF file. When the storing process is complete, the path to the copied file is displayed.

After the self test has been passed, a certificate in PDF format can be exported to an external storage medium.

The certificate can be displayed on a computer and printed. For this purpose, a PDF viewer such as Adobe Reader is required.

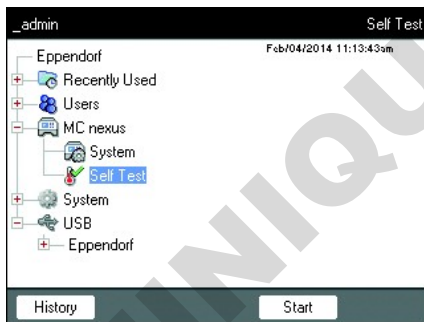

Fig. 8-1: Example of a certificate

### 8.4.3 Displaying, printing or exporting the history

Prerequisites

- A user is logged in (if the *PIN* function is active).
- The navigation tree is displayed.



1. Select the device in the navigation tree.
2. Select the *Self Test* function.
3. Press the *History* softkey.  
The history is displayed.

## Printing the history

### Prerequisites

A supported printer is connected (see operating manual of the thermal cycler).

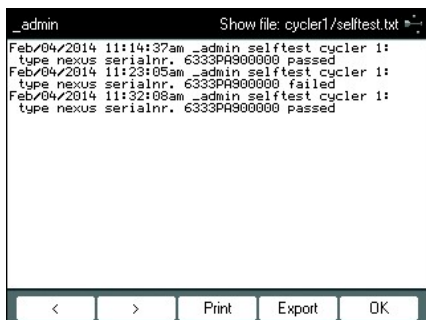

► Press the *Print* softkey.

## 8.5 Managing and backing up data

### 8.5.1 Backing up data

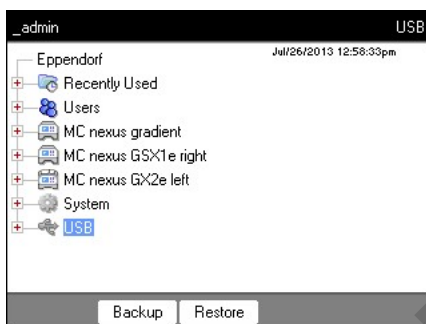

The softkeys in the window above show the possibilities the administrator has to transfer data. Default users can only perform backups here.



#### **NOTICE! Loss of data after creation and restoration of a data backup.**

- Creating a data backup on a USB storage medium: Before the backup is created, the Eppendorf folder on the USB storage medium is completely erased.
- Restoring a data backup: Before the data backup is restored, already existing user nodes, folders and programs on the cycler are erased. Only the data transferred from the storage medium will be available after the restore.

1. Connect a storage medium.

The node for the storage medium appears in the navigation tree.

2. Mark the node for the storage medium.

<i>Backup</i>	Save user nodes, folders and programs to an external storage medium.
<i>Restore</i>	Administrator only: Restore the user nodes, folders and programs saved on the storage medium during a backup.

## 8.5.2 Exporting and importing programs

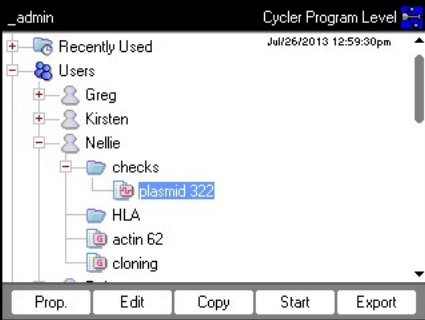
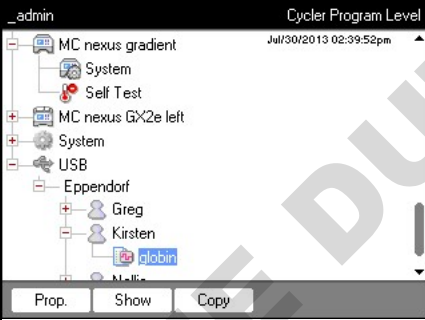
<p><b>Export</b></p>	 <p>1. In the navigation tree, mark the program.        2. Connect a storage medium.        3. Press the <i>Export</i> softkey.        The program is copied to the storage medium.</p> <p>You can transfer the exported programs to another device.</p>
<p><b>Import</b></p>	 <p>1. Connect the storage medium with the exported programs.        2. Open the node for the storage medium and mark the folder or program you would like to import.        3. Press the <i>Copy</i> softkey.        4. Mark the user node or folder at the target location. Press the <i>Paste</i> softkey.</p>

## 8.6 Transferring programs from an older Mastercycler model

PCR programs from older Mastercycler models can easily be transferred to the Mastercycler nexus without optimization of the temperatures and holding times.

- ▶ Enter the program into the Mastercycler nexus editor:

### Gradient protocol on the Mastercycler gradient and analog setting on the Mastercycler nexus gradient

- ▶ Enter the program into the Mastercycler nexus editor:

#### Example

```

1 T = 94.0°      0:02:00
2 T = 94.0°      0:00:15
3 T = 60.0°      0:00:15
+0.0°           +0:00
R = 3.0°/s      +0:0°/s
G = 10.0°
4 T = 72.0°      0:00:30
5 GOTO 2         REP 29
6 T = 72.0°      0:02:00
7 HOLD 4.0°      ENTER
  
```

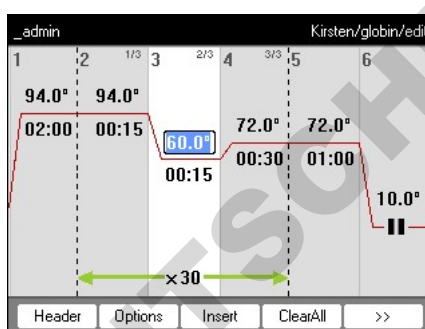

For the Mastercycler nexus you need to enter the gradient spreads. A gradient setting of  $G = 10.0^\circ$  for the Mastercycler gradient corresponds to a gradient spread of  $20.0^\circ\text{C}$  for the Mastercycler nexus gradient. Enter this value in the *Span* field.

► Make the desired settings in the header (see *Editing header settings on p. 50*).

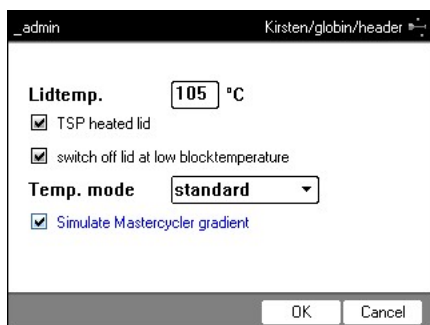

Setting from the Mastercycler 533x program	Corresponding setting in the program header
LID 105°C	<i>Lidtemp.</i>
WAIT <u>△</u>	<i>TSP heated lid</i>
AUTO <u>△</u>	<i>switch off lid at low blocktemperature</i>
CNTRL <u>△</u>	<i>Block = Temp. mode fast</i> <i>Tube = Temp. mode standard or safe</i> Select the <i>Temp. mode</i> setting based on the reaction volume or the sample properties (see p. 50). The temperature control mode for 0.5 mL standard tubes (not thin-walled) is no longer supported on the Mastercycler nexus.
Block temperature control behavior	Check the <i>Simulate Mastercycler gradient</i> checkbox.

- Press the *OK* softkey.  
The editor is displayed.
- Press the *>>* softkey. Press the *Save* softkey.

You can start the program without renewed optimization of the parameters.

## 8.7 Network connection

You can connect the Mastercycler nexus to an Ethernet network in order to send e-mails and protocols. To set up the network connection, you will need the following information from your network administrator:

- IP address, subnet mask and gateway address for the Mastercycler nexus (specified by the network administrator).  
Alternatively, you can assign the IP address automatically via DHCP.
- IP address of the primary DNS server  
You can optionally enter the IP address of a backup DNS server. Alternatively, you can assign the IP address automatically via DHCP.
- For sending e-mails:
  - E-mail address of the sender, user name and password to log into the SMTP-Server (if required)
  - Name or address and port number of the SMTP server
- For sending Syslog messages:
  - Name or address and port number of the syslog server

### 8.7.1 Setting up a network connection

#### Prerequisites

- Ethernet cable (RJ45, Cat.5), not included in the delivery package
- Logged in as an administrator (see p. 37)

Proceed as follows:

1. Select the *System > Network Settings* node.

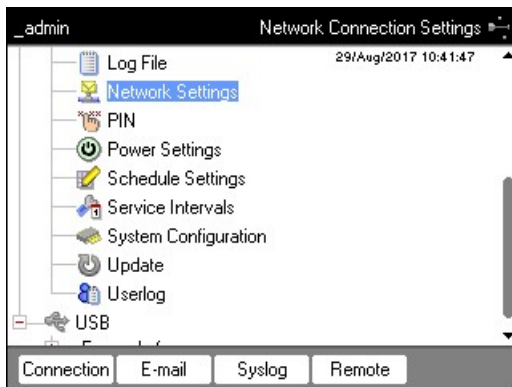

2. Press the *Connection* softkey.

The *Network Connection Settings* window appears.

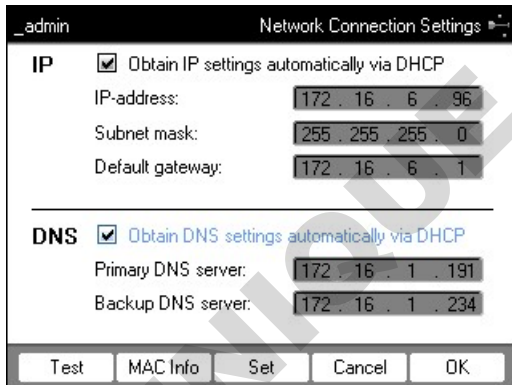

3. To assign the IP address automatically via DHCP, check the *Obtain IP settings automatically via DHCP* checkbox. Alternatively, enter the IP address, subnet mask and standard gateway as specified by your network administrator.
4. To assign the IP address of the DNS server via DHCP, check the *Obtain DNS settings automatically via DHCP* checkbox. Alternatively, enter the IP addresses of the DNS servers as specified by your network administrator.



5. Insert the Ethernet cable into the Ethernet port on the rear of the device and connect it to an Ethernet port of the Ethernet network.
6. Press the *Set* softkey to accept the settings.

 Press the *Test* softkey to test the connection to the default gateway.

 If your network administrator needs the MAC address of the Mastercycler nexus, press the *MAC Info* softkey.

### 8.7.2 Setting up e-mail notifications

Prerequisites

- Network connection has been set up (see p. 84)
- Logged in as an administrator (see p. 37)

Proceed as follows:

1. Select the *System > Network Settings* node.

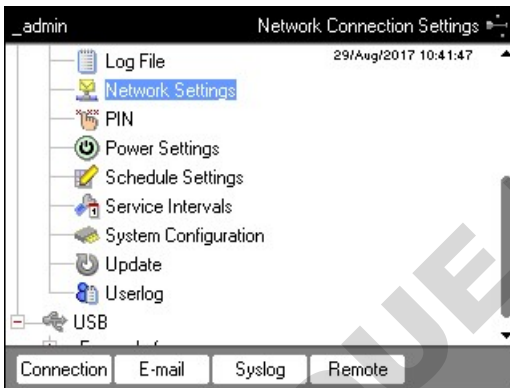

2. Press the *E-mail* softkey.

The *E-mail Settings* window appears.

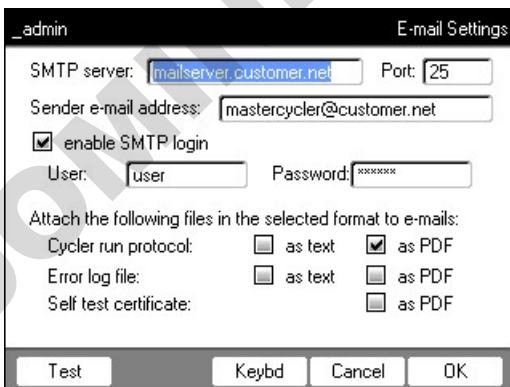

3. Enter the settings as specified by the network administrator.



If the SMTP server requires identification, check the *enable SMTP login* checkbox. Enter user name and password.

4. Select the data you would like to send and its file type.

Selected data, such as protocols, is created by the system and automatically sent to the configured e-mail address.

- *Cycler run protocol*: Protocol of the program run
- *Error log file*: Log file with errors that occurred during the program run
- *Self test certificate*: Self test certificate issued after a successful self test



Press the *Test* softkey to send a test e-mail.

5. Press the *OK* softkey to accept the settings.

### 8.7.3 Setting up syslog messages

Prerequisites

- Network connection has been set up (see p. 84)
- Logged in as an administrator (see p. 37)

Proceed as follows:

1. Select the *System > Network Settings* node.

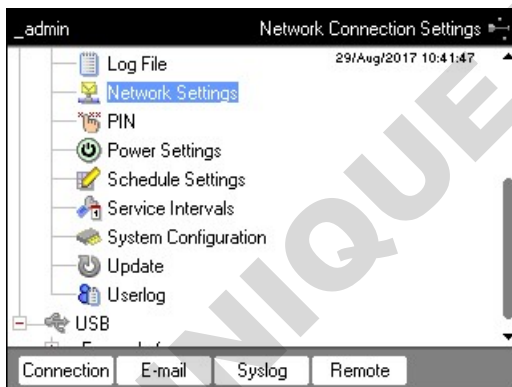

2. Press the *Syslog* softkey.

The *Syslog Settings* window appears.

The screenshot shows a window titled "\_admin Syslog Settings". It is divided into two main sections. The first section, "Syslog Server Setup", contains a checked checkbox for "Enable logging to Syslog server". Below this, there are two input fields: "Syslog server:" with the value "syslog.lab1.customer.net" and "Port:" with the value "514". The second section, "Logging Events", is introduced by the text "Send the following information to the Syslog server:". It contains three checkboxes, all of which are checked: "Cycler run protocol entries:", "Error log file entries:", and "User log file entries:". At the bottom of the window, there are three buttons: "Test", "Cancel", and "OK".

3. To activate log files on the syslog server, check the *Enable logging to Syslog server* checkbox. Enter the server address and the port.
4. Select the information that you would like to create a protocol for.
  - *Cycler run protocol entries*: Protocol of the program run
  - *Error log file entries*: Errors that occurred during the program run
  - *User log file entries*: Protocol of the user actions (e.g., logging in, logging out, editing programs)



Press the *Test* to send a syslog test message.

5. Press the *OK* softkey to accept the settings.

### 8.7.4 Activating remote access

Prerequisites

- Network connection has been set up (see p. 84)
- Logged in as an administrator (see p. 37)

The remote access enables you to connect the device to a network via the VisioNize box.

Proceed as follows:



While updating the device software, remote access must be deactivated.

1. Select the *System > Network Settings* node.

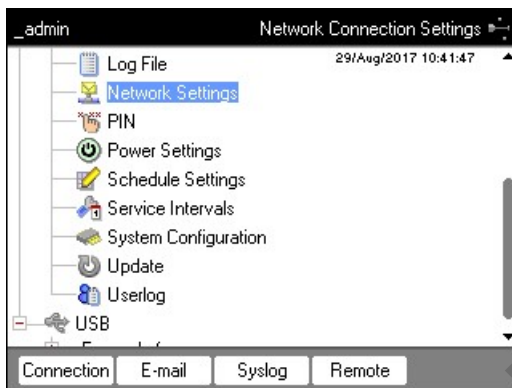

2. Press the *Remote* softkey.

The *Remote Access Setup* window appears.



3. Select the *Allow remote access* checkbox.
4. Press the *OK* softkey.

## 9 Quick start

### 9.1 Login

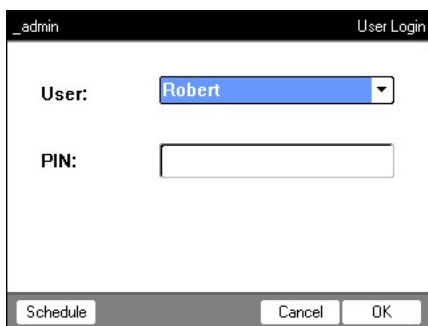

enter

1. Open the list.

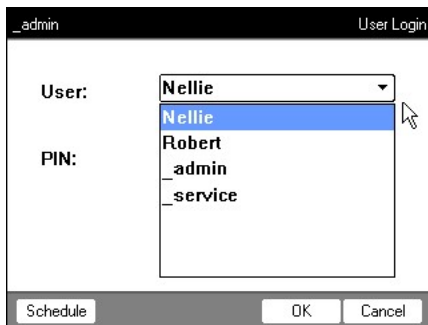

▲

2. Select the user.

▼

enter

3. Confirm your selection.

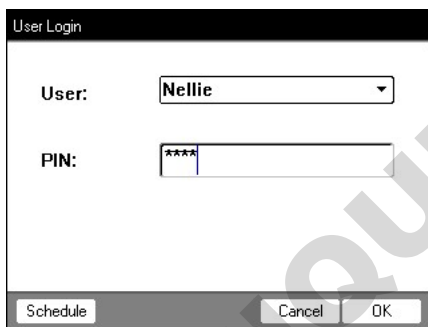

▼

4. Switch to the *PIN*: field.



5. Enter and confirm the PIN.

enter

DOMINIQUE DUTSCHER SAS

## 9.2 Creating folders and programs

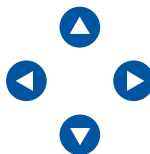
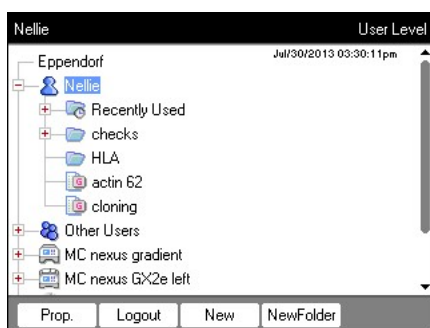

1. Select the user or folder.
2. Press the *New Folder* or *New* softkey.



3. Enter the name and comment and confirm.

## 9.3 Copying folders and programs

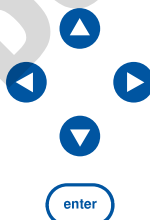
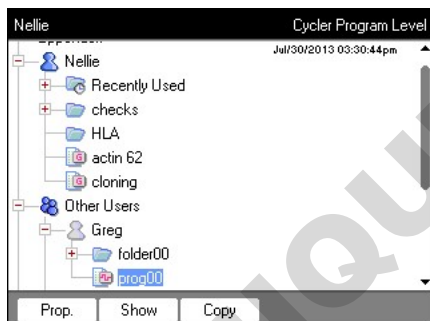

1. Select the folder or program.
2. Press the *Copy* softkey.

3. Confirm the prompt.

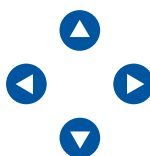
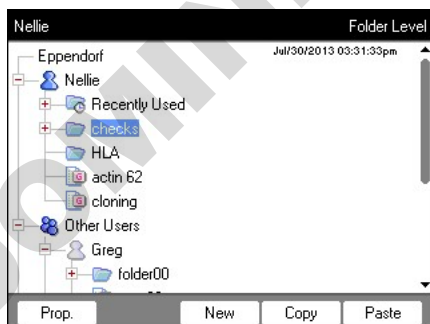

4. Mark the target folder or user.
5. Press the *Paste* softkey.

### 9.4 Deleting folders and programs

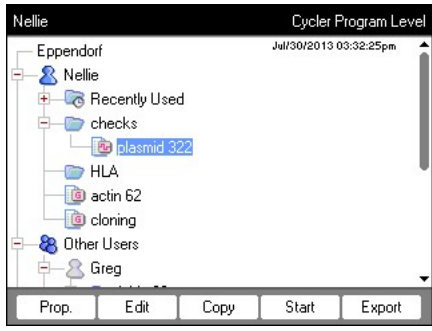

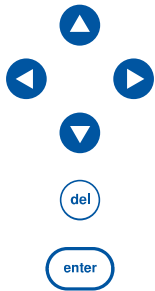

1. Mark the folder or program.
2. Press the **del** key.
3. Press the **enter** key.

### 9.5 Editing programs

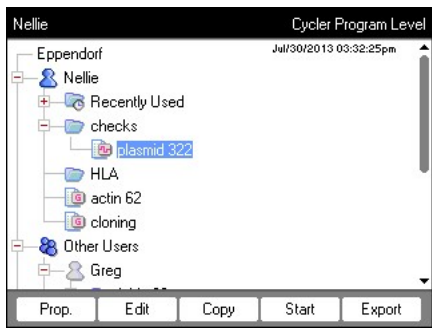

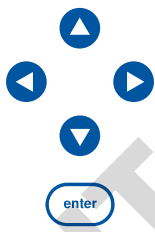

1. Select the program.
2. Open the program editor.



3. Press the *Header* softkey.

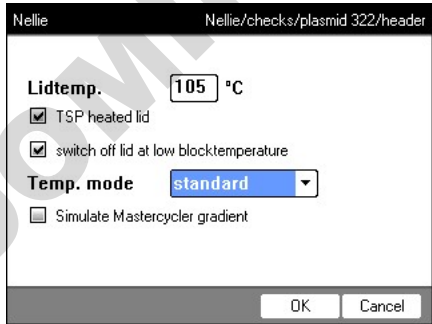

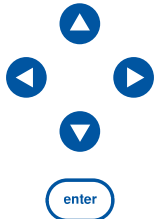

6. Set the temperature control.
7. Confirm your entries.

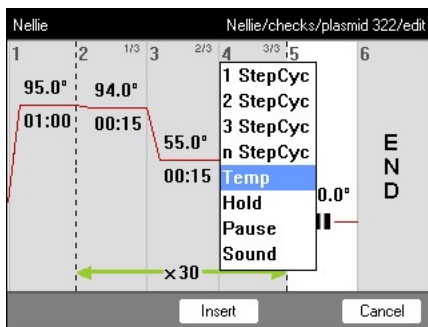

8. Select the program step.
9. Press the *Insert* softkey.

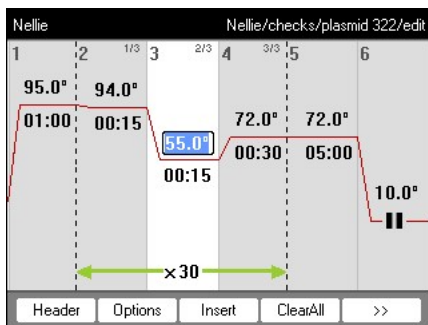

10. Enter the temperatures, holding times and number of cycles.
11. Select the program step.
12. Press the *Options* softkey.

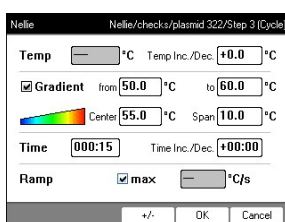

13. Set the gradient, increment and ramp.



14. Confirm your entries.

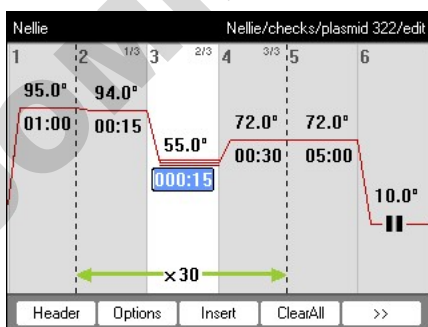

15. Press the >> softkey.
16. Press the *Save* softkey.
17. Press the *Exit* softkey.



## 9.6 Stopping and starting programs

		<ol style="list-style-type: none"> <li>1. Mark the program.</li> <li>2. Insert the sample tubes.</li> <li>3. Close the heated lid.</li> <li>4. Start the program.</li> </ol>											
		<ol style="list-style-type: none"> <li>5. If several cyclers are connected: highlight the cycler.</li> <li>6. Confirm input.</li> </ol>											
<table border="1" data-bbox="186 1077 619 1406"> <thead> <tr> <th>1</th> <th>2</th> <th>3</th> <th>4</th> </tr> </thead> <tbody> <tr> <td>95.0°</td> <td>94.0°</td> <td>55.0°</td> <td>72.0°</td> </tr> <tr> <td>01:00</td> <td>00:15</td> <td>00:07</td> <td>00:19</td> </tr> </tbody> </table> <p>Remaining runtime: 01:02:56          started: 03:37pm end: 04:44pm          Block: 72.0 °C Lid: 105 °C</p> <p>actual step: 4          Cycle: 1 / 30          Temp: 72.0 °C          Time: 00:30</p> <p><b>Running</b></p> <p>Stop Abort Runtime Exit</p>	1	2	3	4	95.0°	94.0°	55.0°	72.0°	01:00	00:15	00:07	00:19	<ol style="list-style-type: none"> <li>7. The following options are available in the status view:             <ul style="list-style-type: none"> <li>• Stop the program: press the <i>Stop</i> softkey.</li> <li>• Abort the program: press the <i>Abort</i> softkey.</li> <li>• Resume the program: press the <i>Resume</i> softkey.</li> </ul> </li> </ol>
1	2	3	4										
95.0°	94.0°	55.0°	72.0°										
01:00	00:15	00:07	00:19										

DOMINIQUE DUTSCHER SAS

## 10 Maintenance

### 10.1 Cleaning



**CAUTION! Risk of burns on the thermoblock, heated lid and reaction vessels.**

The thermoblock, heated lid and reaction vessels reach temperatures of over 50 °C very quickly.

- ▶ Wait until the temperature of the thermoblock, heated lid and reaction vessels is below 30 °C.
- ▶ Then open the heated lid.



**NOTICE! Damage due to aggressive chemicals.**

- ▶ Do not use any aggressive chemicals on the device or its accessories, such as strong and weak bases, strong acids, acetone, formaldehyde, halogenated hydrocarbons or phenol.
- ▶ If the device has been contaminated by aggressive chemicals, clean it immediately using a mild cleaning agent.



**DANGER! Electric shock due to the ingress of liquid.**

- ▶ Switch off the device and disconnect it from the mains/power line before commencing any cleaning or disinfection procedures.
- ▶ Do not allow any liquids to enter the inside of the housing.
- ▶ Do not spray clean or spray disinfect the housing.
- ▶ Do not reconnect the device to the mains/power line unless both the inside and outside of the device are completely dry.



**DANGER! Electric shock.**

- ▶ Switch off the device and disconnect the mains/power plug before commencing any servicing or cleaning procedures.

#### 10.1.1 Cleaning the housing

- ▶ Clean the surfaces of the Mastercycler nexus with a damp, lint-free cloth.
- ▶ If necessary, use a neutral lab cleaner.

Instructions on disinfecting and decontaminating the device can be found separately.

### 10.1.2 Cleaning the heated lid and the thermoblock

1. Open the heated lid.
2. Remove contamination on the thermoblock and the base of the heated lid. Use a damp, lint-free cloth. If necessary, use a neutral lab cleaner.
3. Check to see if there is lettering residue from the tube lids on the heated lid. Remove the residue using ethanol or isopropanol.



Keep the thermoblock bores free of dust and lint. Even small deposits affect the heat transfer between the thermoblock and vessels.

## 10.2 Disinfection/decontamination

---



**NOTICE! Damage from UV and other high-energy radiation.**

- ▶ Do not use UV, beta or gamma rays, or any other high-energy forms of radiation for disinfection.
  - ▶ Avoid storage in areas with high UV radiation.
- 

### Required equipment

- Alcohol (ethanol, isopropanol) or disinfectants containing alcohol

Proceed as follows:

1. Choose the disinfection method which corresponds to the legal regulations and guidelines in place for your range of application.

## 10.3 Decontamination before shipment

If you are shipping the device to the authorized Technical Service for repairs or to your authorized dealer for disposal please note the following:



**WARNING! Risk to health from contaminated device.**

1. Observe the information contained in the decontamination certificate. It is available as a PDF document on our webpage (<https://www.eppendorf.com/decontamination>).
  2. Decontaminate all parts to be shipped.
  3. Include the fully completed decontamination certificate in the shipment.
-

## 11 Troubleshooting

### 11.1 General errors

Technical faults may be triggered by faults such as a power failure or power fluctuations.

In most cases, the following procedure is therefore sufficient:

1. Switch the device briefly off and back on again after about 10 seconds.
2. Check cable connections.
3. If the fault occurs again: Notify your Eppendorf service team.

DOMINIQUE DUTSCHER SAS

DOMINIQUE DUTSCHER SAS

## 12 Transport, storage and disposal

### 12.1 Packing



**CAUTION! Risk of injury due to lifting and carrying heavy loads**

The device is heavy. Lifting and carrying the device can lead to back injuries.

- ▶ Transport and lift the device with an adequate number of helpers.
- ▶ Use a transport aid for transporting the device.



**NOTICE! Damage due to incorrect packing.**

Eppendorf SE is not liable for any damage caused by improper packing.

- ▶ Only store and transport the device in its original packing.



**WARNING! Risk to health due to contaminated device and accessories.**

- ▶ Decontaminate the device and accessories prior to storage or shipping.

Use the supplied packing material when packing the device for transport or storage. If you do not have this anymore or if it is damaged, contact your Eppendorf office.

Prepare the device as follows prior to packing:

1. Pay attention to the decontamination notes (see *Decontamination before shipment on p. 96*).
2. Let the device sit for 30 minutes and make sure there is no condensate in the thermoblock.
3. Load the thermoblock with an empty PCR plate.
4. Close the heated lid.

### 12.2 Disposal

Observe the relevant legal regulations when disposing of the product.

**Information on the disposal of electrical and electronic devices in the European Community:**

Within the European Community, the disposal of electrical devices is regulated by national regulations based on EU Directive 2012/19/EU pertaining to waste electrical and electronic equipment (WEEE).

According to these regulations, any devices supplied after August 13, 2005, in the business-to-business sphere, to which this product is assigned, may no longer be disposed of in municipal or domestic waste. They are marked with the following symbol to indicate this:

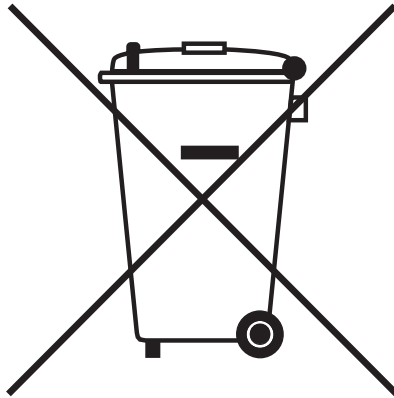

As the disposal regulations may differ from one country to another within the EU, please contact your supplier for more information.

DOMINIQUE DUTSCHER SAS



## 13 Technical data

### 13.1 Power supply

Voltage	100 V – 0 V, ±10 %
Frequency	50 Hz – 60 Hz
Power consumption	max. 700 W
Overvoltage category	II (IEC 61010-1)
Pollution degree	2
Protection class	1

### 13.2 Weight/dimensions

Dimensions	Width: 25.0 cm (9.8 inch) Depth: 41.0 cm (16.1 inch) Height: 32.0 cm (12.6 inch) Height with heated lid open: 44.5 cm (17.5 inch)
Dimensions (devices with a thermoblock with 64+32 wells)	Width: 25.0 cm (9.8 inch) Depth: 41.0 cm (16.1 inch) Height: 33.0 cm (13.0 inch) Height with heated lid open: 44.5 cm (17.5 inch)
Weight (Master variant)	11.0 kg (24.3 lb)
Weight (eco variant)	10.5 kg (23.2 lb)

### 13.3 Ambient conditions

Tab. 13-1: Operation

Environment	For indoor use only No wet location
Ambient temperature	15 °C – 35 °C
Relative humidity	up to 70 %
Atmospheric pressure	up to 2 000 m NN (approx. 80 kPa)

Tab. 13-2: Storage

Ambient temperature	–20 °C – 70 °C
Relative humidity	to 85 %

### 13.4 Application parameters

<b>Mastercycler nexus gradient, Mastercycler nexus gradient eco</b>	
Thermoblock	Universal block, aluminum
Sample capacity	<ul style="list-style-type: none"> <li>• 96 × 0.1 mL PCR tubes</li> <li>• 96 × 0.2 mL PCR tubes</li> <li>• 71 × 0.5 mL PCR tubes</li> <li>• one 96-well PCR plate (unskirted, semi-skirted, skirted; standard and low-profile)</li> </ul>
Thermoblock temperature control range	4 °C – 99 °C
Ramp rate (measured on the thermoblock)	max. 3°C/s
Thermoblock temperature homogeneity (with the gradient function switched off)	
at 35 °C	≤ 0.3 °C
at 90 °C	≤ 0.4 °C
Control accuracy (with the gradient function switched off)	±0.2 °C
Gradient spread	max. 20°C
Gradient temperature control range	30 °C – 99 °C
Heated lid temperature control range	37 °C – 110 °C
<b>Mastercycler nexus, Mastercycler nexus eco</b>	
Thermoblock	Universal block, aluminum
Sample capacity	<ul style="list-style-type: none"> <li>• 96 × 0.1 mL PCR tubes</li> <li>• 96 × 0.2 mL PCR tubes</li> <li>• 71 × 0.5 mL PCR tubes</li> <li>• one 96-well PCR plate (unskirted, semi-skirted, skirted; standard and low-profile)</li> </ul>
Thermoblock temperature control range	4 °C – 99 °C
Ramp rate (measured on the thermoblock)	max. 3°C/s
Thermoblock temperature homogeneity	
at 35 °C	≤ 0.3 °C
at 90 °C	≤ 0.4 °C
Control accuracy	±0.2 °C
Gradient spread	–
Gradient temperature control range	–
Heated lid temperature control range	37 °C – 110 °C

**Mastercycler nexus GX2, Mastercycler nexus GX2e**

Thermoblock	Universal block, aluminum
Sample capacity	<ul style="list-style-type: none"> <li>• 96 × 0.1 mL PCR tubes</li> <li>• 96 × 0.2 mL PCR tubes</li> <li>• 64 × 0.5 mL PCR tubes</li> <li>• one 64-well PCR plate (unskirted, semi-skirted, skirted; standard and low-profile)</li> <li>• one 32-well PCR plate (unskirted, semi-skirted, skirted; standard and low-profile)</li> </ul>
Thermoblock temperature control range	4 °C – 99 °C
Ramp rate (measured on the thermoblock)	max. 3°C/s
Thermoblock temperature homogeneity (with the gradient function switched off)	
at 35 °C	≤ 0.3 °C
at 90 °C	≤ 0.4 °C
Control accuracy (with the gradient function switched off)	±0.2 °C
<b>Thermoblock with 64 wells</b>	
Gradient spread	max. 12°C
Gradient temperature control range	30 °C – 99 °C
Heated lid temperature control range	37 °C – 110 °C
<b>Thermoblock with 32 wells</b>	No gradient function
Gradient spread	–
Gradient temperature control range	–
Heated lid temperature control range	37 °C – 110 °C

<b>Mastercycler nexus X2, Mastercycler nexus X2e</b>	
Thermoblock	Universal block, aluminum
Sample capacity	<ul style="list-style-type: none"> <li>• 96 × 0.1 mL PCR tubes</li> <li>• 96 × 0.2 mL PCR tubes</li> <li>• 64 × 0.5 mL PCR tubes</li> <li>• one 64-well PCR plate (unskirted, semi-skirted, skirted; standard and low-profile)</li> <li>• one 32-well PCR plate (unskirted, semi-skirted, skirted; standard and low-profile)</li> </ul>
Thermoblock temperature control range	4 °C – 99 °C
Ramp rate (measured on the thermoblock)	max. 3°C/s
Thermoblock temperature homogeneity at 35 °C at 90 °C	≤ 0.3 °C ≤ 0.4 °C
Control accuracy	±0.2 °C
Gradient spread	–
Gradient temperature control range	–
Heated lid temperature control range	37 °C – 110 °C

## Index

### 1

1 ... 3 StepCyc (program step) .....52

### A

Access rights .....67

Adjustment .....75

Administrator functions.....67

#### Alarm

    Activate .....70

    Deactivate .....70

Attach (devices) .....27

Auto-Restart .....75

### B

Backup.....80

Block type.....75

### C

CAN connection .....30

Change country settings.....70

#### Cleaning

    Heated lid.....96

    Housing.....95

    Thermoblock.....96

Connecting the mouse.....29

Connecting the printer .....29

Country settings .....70

### D

Decontamination .....96

Defining the administrator PIN .....35

#### Devices

    Attach.....27

    Separate .....28

Disinfection .....96

Disposal ..... 99

### E

E-mail address ..... 83

E-mail notification ..... 36, 83

#### Eco device

    connect.....29

Export ..... 81

    Program.....57

### F

fast (header setting)..... 51

#### Folder

    Change comment ..... 42

    Change name.....42

    Copy .....43

    Create new.....41

    Delete .....43

    Import.....81

### G

Gradient ..... 49, 54

### H

#### Heated lid

    Close.....34

    Open .....33

    Switch lid heater off automatically..... 51

    Temperature control prior to program start.... 50

Hold (program step) ..... 52

Holding time increment..... 49

### I

IP address ..... 83

### L

#### Log file

    Displays ..... 70

    Export.....70

Login.....37

**Index**

Mastercycler® nexus  
English (EN)

Logout .....	38	Set temperature control speed .....	54
		Set temperature increment .....	54
<b>N</b>		Program header	
Navigation tree .....	39	Heated lid .....	50
n StepCyc (program step).....	52	Set lid temperature.....	50
		Simulate Mastercycler gradient .....	51
		Switch off lid at low block temperature .....	51
		Temp. mode.....	51
<b>P</b>		Program template	
Pause (program step) .....	52	Template.....	58
PDF.....	41		
<b>PIN</b>		<b>R</b>	
Activate .....	70	Restart.....	75
Administrator .....	35	Restore .....	80
Change .....	69		
Deactivate .....	70	<b>S</b>	
Define.....	35	safe (header setting) .....	51
Power saving mode .....	71	Sample tubes	
Program		Inserting .....	60
Change comment .....	43	Select.....	59
Continue.....	64	Sample volume .....	60
Copy .....	43	Schedule .....	71
Create new .....	42	Display.....	46
Delete.....	43	Edit .....	45
Edit header.....	50	Use .....	44
Export.....	57, 81	Selecting a location .....	25
Import .....	81	Self test .....	76
Interrupt.....	64	Service intervals .....	72
Rename .....	43	Set date .....	70
Restore .....	80	Set time.....	70
Save.....	80	Simulate Mastercycler 5333/5331 .....	51
Start.....	61	Sound (program step).....	52
Stop .....	64	Space requirements.....	25
Transfer .....	82	standard (header setting) .....	51
Write protection.....	43	Standby .....	47
Program editor		Status view.....	62
Create gradient step.....	54	Status view, common.....	63
Description.....	49	Storage medium	
Editing parameters.....	53		
Exit.....	57		
Extended options .....	54		
Header.....	50		
Insert step .....	51		
Open.....	49		
Saving a program.....	57		
Set gradient.....	54		
Set holding time increment.....	54		

Connect .....	40
Labware .....	41
Use .....	40
Switch	
Eco (right/left) .....	30
Term (off/on) .....	30
Switch lid heater off automatically .....	51
System configuration .....	72
System settings .....	70

## T

Temp (program step) .....	52
Temp. mode .....	51
Temperature control speed .....	49, 54
Temperature increment .....	49, 54
Text file format .....	41
Thermoblock	
Adjust .....	75
Load .....	59
Sample volume .....	60
Self test .....	76
Verification .....	75
Time increment .....	54
TSP	
Switching off .....	50
Switching on .....	50
TXT .....	41

## U

USB	
Ports .....	29
User account	
Access rights .....	67
Create .....	67
Delete .....	68
Edit .....	68
User log	
Delete .....	73
Displays .....	73
Export .....	73

## Users

Change .....	38
Guest .....	38
Login .....	37
Logout .....	38

## V

Verification .....	75
--------------------	----

DOMINIQUE DUTSCHER SAS



# Declaration of Conformity

The product named below fulfills the requirements of directives and standards listed. In the case of unauthorized modifications to the product or an unintended use this declaration becomes invalid.

**Product name:**

Mastercycler® nexus, Mastercycler® nexus X2, Mastercycler® nexus X2e  
Mastercycler® nexus flat, Mastercycler® nexus eco, Mastercycler® nexus flat eco,  
Mastercycler® nexus gradient, Mastercycler® nexus gradient eco,  
Mastercycler® nexus GSX1, Mastercycler® nexus GSX1e,  
Mastercycler® nexus GX2, Mastercycler® nexus GX2e,  
Mastercycler® nexus SX1, Mastercycler® nexus SX1e

**Product type:**

Thermocycler

**Relevant directives / standards:**

2014/35/EU: EN 61010-1, EN 61010-2-010  
UL 61010A-1, CSA C22.2 No. 61010-1  
2014/30/EU: EN 55011, EN 61326-1  
2011/65/EU: EN 50581

**Date:** March 10, 2016



Management Board



Portfolio Management

**Your local distributor:** [www.eppendorf.com/contact](http://www.eppendorf.com/contact)  
Eppendorf AG · 22331 Hamburg · Germany  
[eppendorf@eppendorf.com](mailto:eppendorf@eppendorf.com)

Eppendorf® and the Eppendorf logo are registered trademarks of Eppendorf AG, Germany.  
U.S. Design Patents are listed on [www.eppendorf.com/ip](http://www.eppendorf.com/ip).  
All rights reserved, incl. graphics and pictures. Copyright 2015 © by Eppendorf AG.

[www.eppendorf.com](http://www.eppendorf.com)

ISO 9001  
Certified

ISO  
13485  
Certified

ISO  
14001  
Certified

Measurement of sound power level according to  
DIN EN ISO 3744: 2011-02 / EN ISO 3744:2010

**PCR-Cycler**

Eppendorf AG, 22331 Hamburg, Germany

1. **Machine:**

1.1 Type: Eppendorf MCnexus  
1.2 Serial Number: FT-6331-28  
1.3 Year of construction: 2011

2. **Specifications:**

See documents of the manufacturer

3. **Measurement system:**

3.1 Calibrated sound level meter: Norsonic 118

4. **Measurement surface:**

4.1 Measurement surface: hemisphere with 10 measuring points  
4.2 Measurement distance: 1 m

5. **Measurement conditions:**

5.1 Environment: Free field over a reflecting plane  
5.2 Environmental correction  $K_{2A}$ : 0.7 dB(A)  
5.3 accuracy class: 2  
5.4 Operating conditions: PCR cyclus

6. **Measurement surface sound pressure level:** 31.2 dB(A)  
**Sound power level:** 39.2 dB(A)

TÜV Nord Umweltschutz GmbH & Co. KG

Große Bahnstraße 31, 22525 Hamburg

Nr. 111UBS165 Date of measurement: 22.10.2011

  
Dipl.-Ing. C. Michalke

**DOMINIQUE DUTSCHER SAS**

# Evaluate Your Manual

Give us your feedback.  
[www.eppendorf.com/manualfeedback](http://www.eppendorf.com/manualfeedback)

DOMINIQUE DUTSCHER SAS