

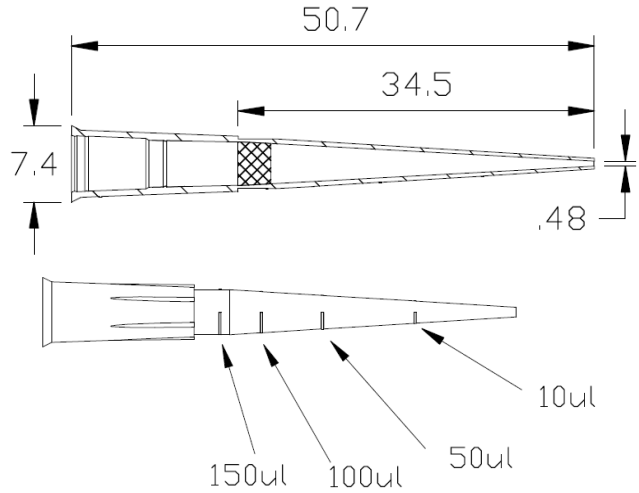

100 µl (1-100 µl) Barrier - Catalog #30380T



Catalog #	Description
30380T	Natural, Polypropylene, Sterile, Low Retention

Packaging Type	Packaging Details
Racked Tips	Sterile, LR, 96 Tips/Rack, 10 Racks/Pack, 5 Packs/Case, HNG Rack

Attributes



Material: Polypropylene
Volume Range: 1-100 µl
Grad Lines: Graduation Line

Certified RNase/DNase Free
 Certified Human DNA Free
 Certified PCR Inhibitor Free
 Certified Pyrogen Free