

Valid for Item-No.: 651101, 651160, 651161, 651180

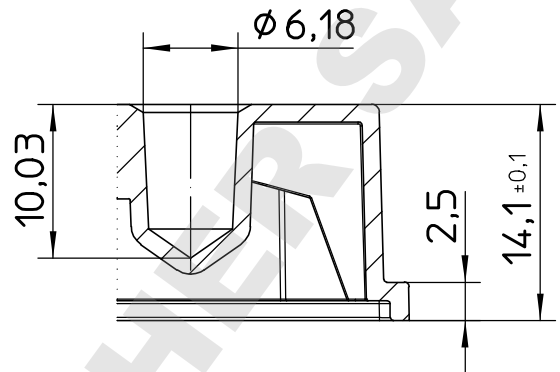

Curvature max.0,2

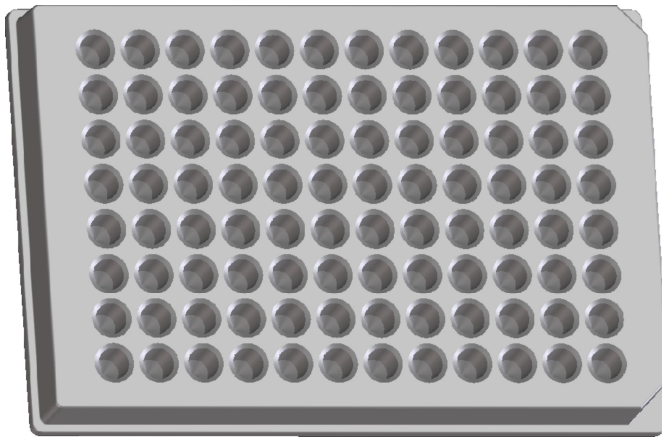
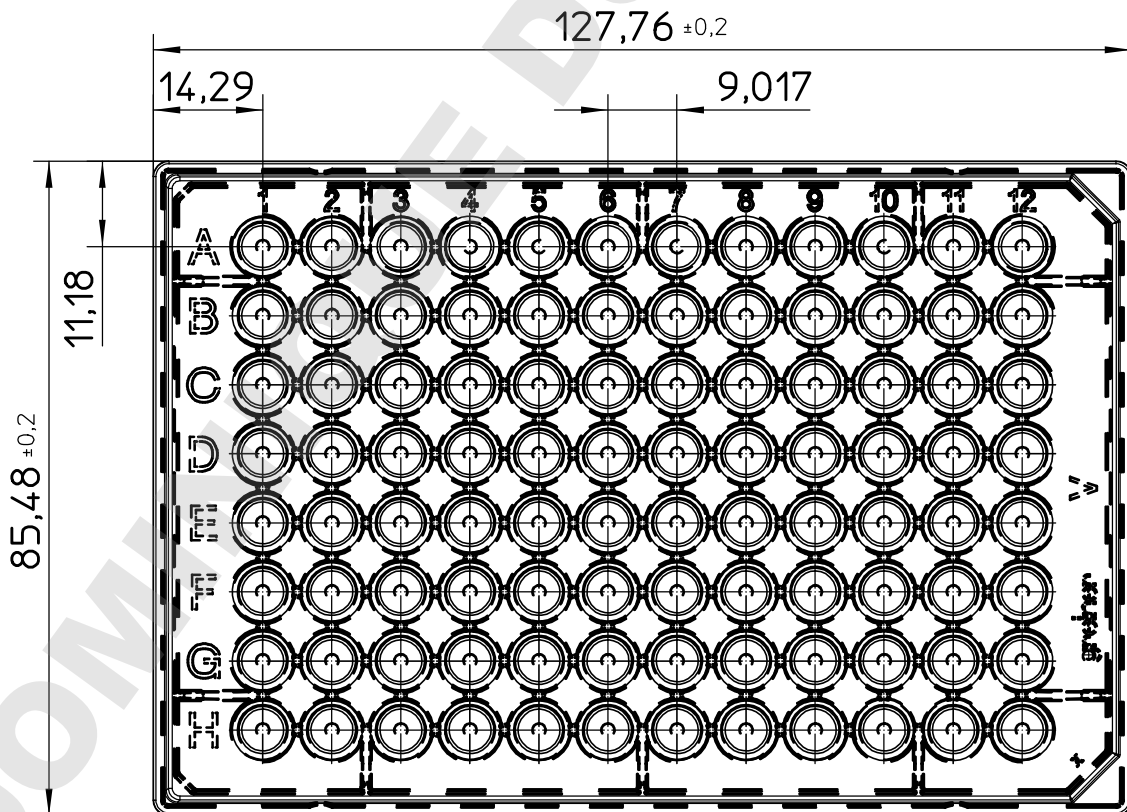
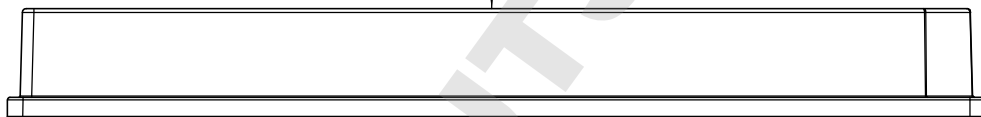

"All dimensions in mm"

Customer drawing subject to change without notice!

Uncontrolled Copy

Prior Issue	Drawn	Approved	Released	CONFIDENTIAL: Information contained in this document or drawing is confidential and proprietary to Greiner Bio-One GmbH. This document may not be reproduced for any reason without written permission from Greiner Bio-One GmbH. All rights of design, invention, and copyright are reserved.
Revision 1	Date 2015/03/16	Date 2017/02/23	Date 2017/02/23	
Date 2015/03/16	Name schwarzj	Name schwarzj	Name sonntag	

Valid for Item-No.: 651101, 651160, 651161, 651180

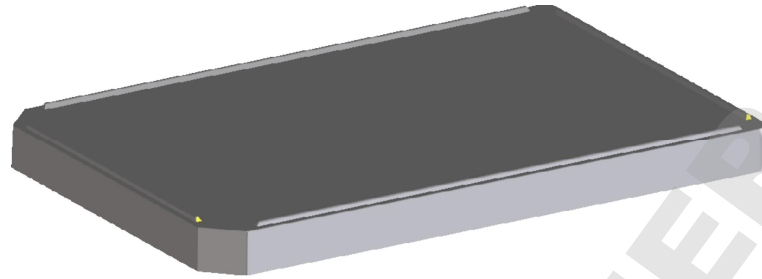

Curvature $+0,3$
 $-0,3$

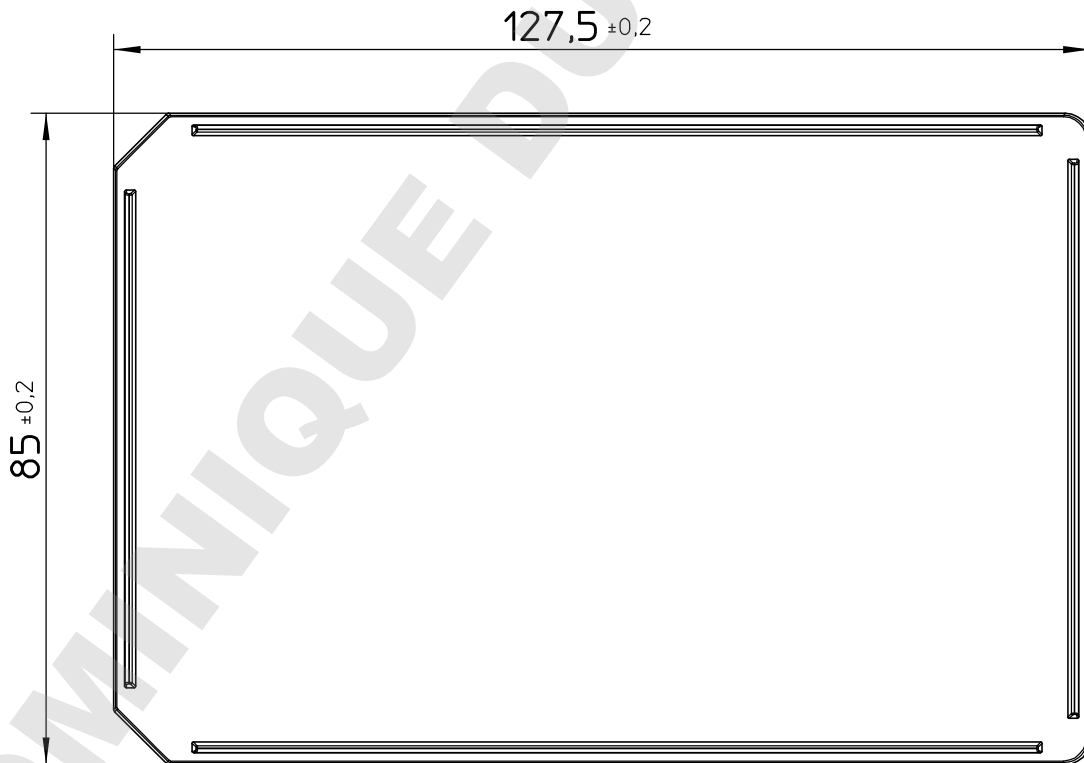
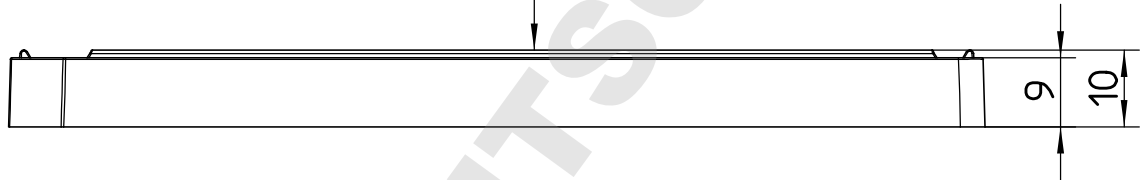

Only Part.-No. 651180 with lid

"All dimensions in mm"

Customer drawing subject to change without notice!

Uncontrolled Copy

Prior Issue	Drawn	Approved	Released	CONFIDENTIAL: Information contained in this document or drawing is confidential and proprietary to Greiner Bio-One GmbH. This document may not be reproduced for any reason without written permission from Greiner Bio-One GmbH. All rights of design, invention, and copyright are reserved.
Revision 1	Date 2015/03/16	Date 2017/02/23	Date 2017/02/23	
Date 2015/03/16	Name schwarzj	Name schwarzj	Name sonntag	