

1974 - 2024
50 YEARS

steriCLIN®



**EVERYTHING
FOR THE CSSD**

RESPONSIBILITY RESULTS IN COMMITMENT.
FOR MORE THAN 50 YEARS

The stericlin® colour guidance system

Make it easy for yourself and use our stericlin® colour coding system for orientation. It visualizes the differentiation between our individual product areas. This way, you will always have an overview when browsing through our catalog and will find the category you are looking for as quickly as possible. But that's not all! In addition to the colour codes, we have provided each product category with its own icon, whose symbolism briefly and concisely reflects the content of the next page.





OR accessories

Supplies for surgical use and patient care in the operating theatre



Personal protective equipment

Medical protective equipment you can rely on!



Cleaning accessories

Chemical indicators for monitoring the sterilisation process and to supplement the parametric process documentation



Indicator systems

Chemical indicators for monitoring the sterilisation process and to supplement the parametric process documentation



See-through packaging

Made of various combinations of materials to pack instruments and individual parts



Wrapping material

In different designs, sizes, colours and combinations - for instrument baskets and sets



CSSD accessories

Sterilisation accessories from stericlin® for maximum safety and to facilitate the work in the CSSD



Labelling / documentation

Identification, controlling, documentation and tracking of sterile barrier systems and medical devices



Sterile goods logistics

For safe sterilisation, transportation and storage of your medical devices

We offer you more ...!



Service and consulting

For us, service and satisfied customers are at the heart of everything we do. We advise and support our customers worldwide in seven languages. The constantly increasing demands on your personnel in the central sterile supply department and specialist departments require permanent training. We support you in this! Our competent staff will provide you with detailed theoretical and practical training on site on the correct use of sterile barrier systems, sterilisation accessories and indicator systems. Furthermore, we organize specialized events and workshops.



+49 (0) 9852 901-289



contact@stericlin.com

Quality & safety

Our sterile barrier systems are manufactured on modern production lines under clean room conditions and on the basis of carefully validated production processes. This includes non-stop control of the production process and complete IT-supported traceability of all materials used. As a stericlin® customer, you can rely on the quality of our products at all times.



Product portfolio

Our broad product range includes indicator systems, sterile barrier systems, sterilisation accessories, products for labeling and documentation, sterile goods logistics products, and hygiene products. Our claim is to continuously develop our products based on your requirements and the applicable standards and laws for medical devices.



Delivery capability

Our high storage capacity and state-of-the-art warehouse technology guarantee safe loading and short-term delivery to you. We maintain a holistic system of interconnected processes, the optimization of which leads to an ever-increasing reduction in response and delivery times.



Climate protection

Environmentally conscious action is part of our corporate policy: We work ecologically sustainable. In addition, we meet all requirements of EN ISO 14001 in the field of environmental management and EN ISO 50001 in the field of energy management.

OR accessories



Polypropylene button cannula	11
Plastic bowls	12
Vascular loops	14
Suture booties	15

Personal protective equipment



Nitrile protective gloves	17
Full face visor	18

Cleaning accessories



Surface cleaning brushes	20
Brushes for hollow instruments	22
Cleaning brushes for endoscopes	26
Cleaning accessories	28

Indicator systems



Cleaning efficacy indicators and tests	
Tosi®	31
SonoCheck	34
HemoCheck-S	35
Pyromol-Test	36
Pyromol-E-Test	37
HydroCheck-E	38
EndoSwab	39
pH-Check	40
Bowie-Dick tests	41
BMS 1200 Batch Monitoring System	43
Type 6, 5, 4, 1 indicator strips	44

See-through packaging



Made of paper and film	50
Made of non-woven and film	54
Made of DuPont™ Tyvek® and film	55
Paper bags with gusset	56

Wrapping material



Double wrap SMS 6 Plus/SMS 6 Plus	59
Double wrap SMS/SMS	60
Double wrap SMS/non-woven	61
Interleaved SMS/SMS	62
Interleaved SMS/non-woven	63
Interleaved non-woven/non-woven	64
SMS 6 Plus	65
Polypropylene (SMS)	66
Non-woven	67
Crepe	68



CSSD accessories



Adhesive tapes and accessories	70
Tray accessories	
Tray labels	72
Silicone plugs	74
Corner reinforcement	75
Tray liners	76
Container accessories	
Absorbent inner layers	77
Seals	78
Container tags and -labels	82
Accessories for small set mini & dental containers	82
Container filters	86
Instrument protection	
Made of paper and film	87
Highline instrument protection caps	88
Cable ties made of silicone	92
Seal seam integrity tests	94
Protective packaging	
Dust cover bags for sterile barrier systems	96
Safety bags for disinfected medical devices	97
Safety bags for explants	98
Hygiene products	
Hygiene wipes	99
Hygiene and waste bags	100

Labeling / documentation



Documentation labels	
Labels for thermal transfer printers	102
Hand labelling device with accessories	108
Labels for manual labelling/markings	109
Patient-related batch traceability documentation system	110
Info labels with imprint	112
Fibre-tip pens	111
Instrument tags	115
Thermal transfer films	116

Sterile goods logistics



Transport solutions	118
Instrument basket tags	123
Mesh covers made of silicone	128
Silicone mesh mats	129
Trays, baskets and accessories	130
Silicone mountings	140
Special trays	142
Endoscope baskets	144

We deliver in more than 70 countries

No distance is too far for stericlein®. Worldwide contacts, on site for you in many countries, and our competent sales office ensure optimal, comprehensive advice and a smooth ordering process. The heart of our activities is the production and logistics site in Germany. From this central location, we supply your needs fast and reliable.



Your advantages as a stericlin® customer / Made in Germany

Responsibility results in commitment – for more than 45 years

Why stericlin®?

For more than 40 years we produce, under the brand name stericlin®, indicator systems, sterile barrier systems and sterilisation accessories. Our customers include hospitals, doctor's offices and service providers in Germany and more than 70 other countries.

Quality and safety

Our sterile barrier packaging materials are manufactured in modern production plants under clean room conditions and on the basis of carefully validated production processes. These include around the clock in-process controls and complete IT-based traceability of all materials used. As a stericlin® customer, you can always rely on the quality of our products.

Requirements to meet the standard

The requirements of national and international standards and laws for medical devices form the basis for the development and manufacturing of our products. To ensure a constant and repeatable quality, we have implemented a quality management system according to ISO 9001 and ISO 13485. Our production takes place in clean rooms of class ISO 7 and ISO 8 according to EN ISO 14644 part 1 and 3. Our relevant international standards are the EN ISO 11140-4 and 11140-3 for Bowie-Dick test systems, the EN 867-5 for batch monitoring systems and EN ISO 11607 and EN 868 for sterile barrier systems. In addition, we let our products be checked externally for the compliance with the strict standard requirements. For example, our Bowie-Dick single use test pack has obtained the Kitemark of the British Standards Institution (BSI), a prestigious and internationally recognised test institute.

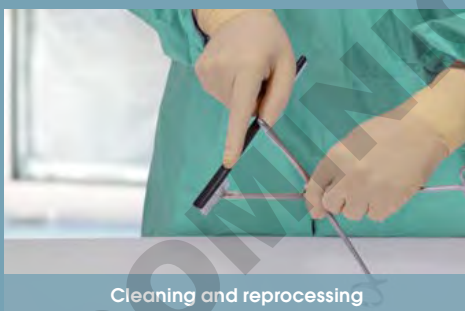

Cleaning and reprocessing



Packing instruments and individual parts

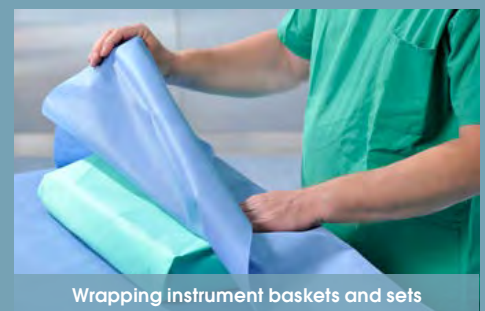

Wrapping instrument baskets and sets



Labeling, marking and documentation



Transportation and storage



Monitor and validate processes



OR accessories



Supplies for surgical use and patient care in the operating theatre

- Polypropylene button cannula
- Plastic bowls
- Vascular loops
- Suture booties

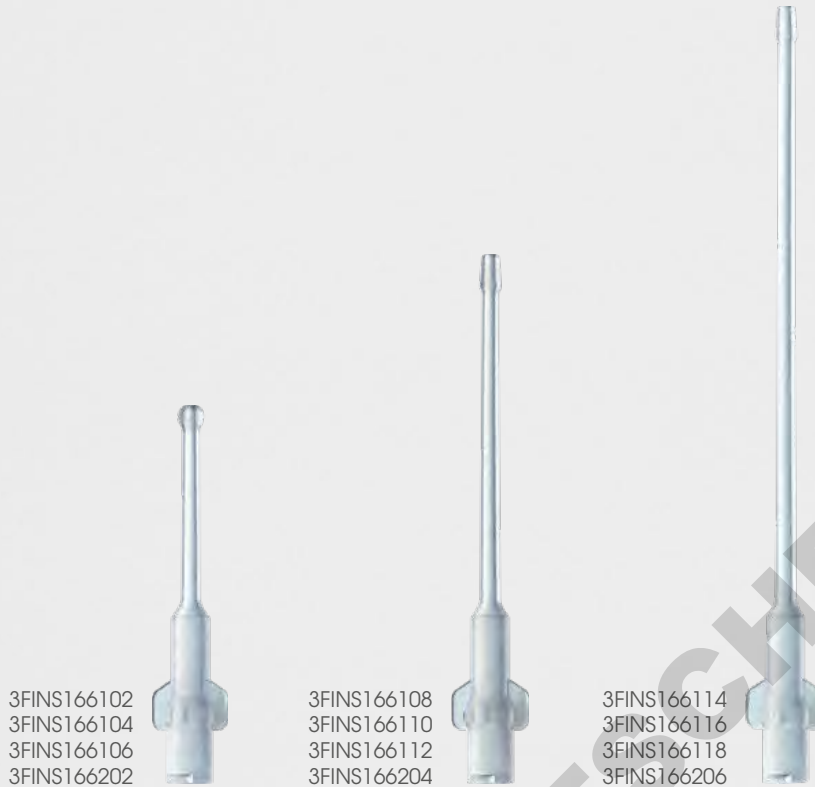

Polypropylene button cannula

Intended for surgically invasive irrigation, application and aspiration as well as for non-invasive use

The plastic cannulas are made of high-quality medical polypropylene and offer the advantage over comparable cannulas on the market that they are approved as a class IIa medical device according to EU-MDR for surgically invasive use. This means that the cannulas can also be used for applications beyond pure topical wound irrigation. Already sterile packed, the cannulas are a hygienic and cost-effective alternative to conventional stainless steel multi-use or disposable cannulas.

The bendability of the cannulas up to 45° makes the purchase of different curved cannulas unnecessary.

In order to meet all quality requirements, no plasticisers (DEHP) or latex are used in production.

We offer the cannulas both sterile packed and non-sterile.

Article No.	Packaging	Total length (mm)	Working length (mm)	Diameter (mm)	Pack (pcs.)
3FINS166102	sterile	50	28	0,9	24
3FINS166104	sterile	50	28	0,9	48
3FINS166106	sterile	50	28	0,9	200
3FINS166108	sterile	70	48	0,9	24
3FINS166110	sterile	70	48	0,9	48
3FINS166112	sterile	70	48	0,9	150
3FINS166114	sterile	103	81	1,0	24
3FINS166116	sterile	103	81	1,0	48
3FINS166118	sterile	103	81	1,0	150
3FINS166202	non-sterile	50	28	0,9	200
3FINS166204	non-sterile	70	48	0,9	150
3FINS166206	non-sterile	103	81	1,0	150



Disposable plastic bowls

For hygienic and efficient work in various functional areas

The reprocessing of reusable bowls is time-, resource- and cost-intensive. By using disposable bowls, internal processes in the CSSD can be streamlined and capacities thus gained can be sensibly used elsewhere. A comprehensive range of sizes and colours offers a variety of uses in different departments.

All bowls are equipped with an internal measuring scale.

Article No.	Design	Fill quantity (ml)	Colour	Pack (pcs.)
3FSOP187202	non-sterile	250	clear	500
3FSOP187204	non-sterile	250	blue	500
3FSOP187206	non-sterile	250	red	500
3FSOP187208	non-sterile	250	green	500
3FSOP187210	non-sterile	250	yellow	500
3FSOP187212	non-sterile	500	clear	300
3FSOP187214	non-sterile	500	blue	300
3FSOP187218	non-sterile	500	green	300
3FSOP187224	non-sterile	1000	blue	270

Article No.	Design	Fill quantity (ml)	Colour	Pack (pcs.)
3FSOP187102	sterile	250	clear	50
3FSOP187104	sterile	250	blue	50
3FSOP187106	sterile	250	red	50
3FSOP187108	sterile	250	green	50
3FSOP187110	sterile	250	yellow	50
3FSOP187112	sterile	500	clear	40
3FSOP187114	sterile	500	blue	40
3FSOP187118	sterile	500	green	40
3FSOP187124	sterile	1000	blue	30

Article No.	Design	Fill quantity (ml)	Colour	Pack (pcs.)
3FSOP187250	Lid, non-sterile	suitable for 250 ml bowls	clear	500
3FSOP187150	Bowl incl. lid, sterile	250	clear	50
3FSOP187152	Bowl incl. lid, sterile	250	blue	50
3FSOP187154	Bowl incl. lid, sterile	250	red	50
3FSOP187156	Bowl incl. lid, sterile	250	green	50
3FSOP187158	Bowl incl. lid, sterile	250	yellow	50
3FSOP187160	Set incl. 3 Bowls, sterile	1x 250; 2x 500	blue	40
3FSOP187260	Bowl, rectangular, non-sterile 200 x 70 x 30 mm	200	blue	350 (underpacked to 50)



3FSOP187304



3FSOP187318



3FSOP187324

Reusable plastic bowls

As an economical alternative to stainless steel bowls

Reusable plastic bowls offer a variety of uses due to the available colours and sizes. For example, consumables (e.g. swabs, compresses, instruments, suture material, etc.) can be easily separated from each other with the help of different colours and quickly checked for completeness postoperatively. In addition, the bowls are an enormous relief for the budget due to the low purchasing costs.

Multiple reprocessing by the most common cleaning, disinfection and steam sterilisation procedures is possible.

All bowls are equipped with an internal measuring scale.

Article No.	Design	Fill quantity (ml)	Colour	Pack (pcs.)
3FSOP187304	Bowl, non-sterile	150	blue	10
3FSOP187308	Bowl, non-sterile	150	green	10
3FSOP187310	Bowl, non-sterile	150	yellow	10
3FSOP187314	Bowl, non-sterile	500	blue	10
3FSOP187318	Bowl, non-sterile	500	green	10
3FSOP187320	Bowl, non-sterile	500	yellow	10
3FSOP187324	Bowl, non-sterile	1000	blue	10
3FSOP187334	Bowl, non-sterile	2500	blue	10

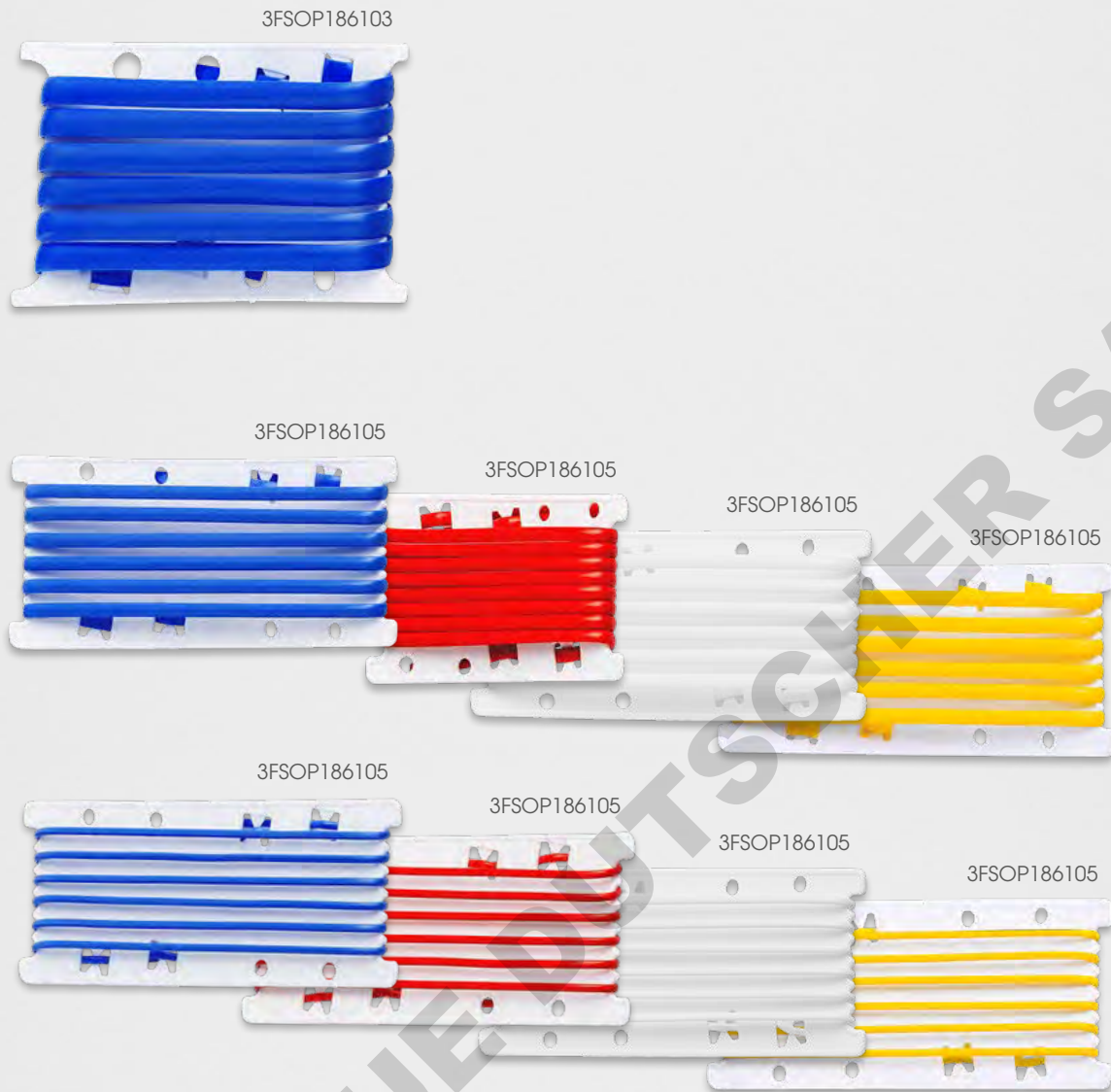

Vascular loops

Used for intraoperative organisation and identification of arteries, veins, nerves or tendons

The four colours and different variants can be used to identify vessels and anatomical structures.

Vascular loops are radiopaque, latex-free, sterile packed and declared for single use.

Article No.	Description	Size (mm)	Length (cm)	Colour	Pack (pcs.)
3FSOP186103	maxi-super	5,0 x 1,5	47,5	blue	200 (10 boxes of 10 x 2 pieces)
3FSOP186105	maxi	2,5 x 1,2	47	blue	200 (10 boxes of 10 x 2 pieces)
3FSOP186107	maxi	2,5 x 1,2	47	red	200 (10 boxes of 10 x 2 pieces)
3FSOP186109	maxi	2,5 x 1,2	47	white	200 (10 boxes of 10 x 2 pieces)
3FSOP186111	maxi	2,5 x 1,2	47	yellow	200 (10 boxes of 10 x 2 pieces)
3FSOP186113	mini	1,5 x 1,0	48	blue	200 (10 boxes of 10 x 2 pieces)
3FSOP186115	mini	1,5 x 1,0	48	red	200 (10 boxes of 10 x 2 pieces)
3FSOP186117	mini	1,5 x 1,0	48	white	200 (10 boxes of 10 x 2 pieces)
3FSOP186119	mini	1,5 x 1,0	48	yellow	200 (10 boxes of 10 x 2 pieces)

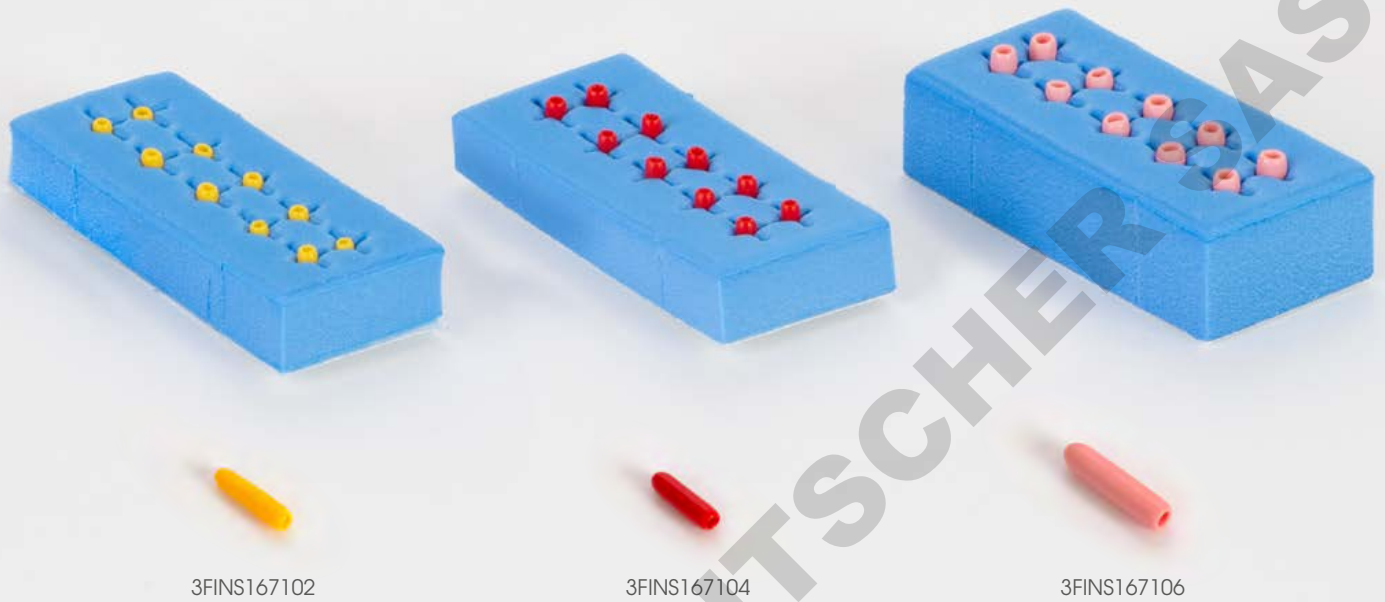

Suture booties

Protect thin and delicate suture material from damage by sharp-edged needle holders

The non-slip surface allows suture material to be held securely and can also be marked using the different colours.

Quick and safe attachment to the instrument is made possible by the paired arrangement. The dispensers are equipped with a self-adhesive back.

A check for completeness can be carried out quickly postoperatively due to the clear design of the dispensers.

The instrument pads are radiopaque, latex-free, sterile packaged and declared for single use.

Article No.	Size	Colour	Pack (pcs.)
3FINS167102	normal	yellow	25 (5 pairs / pad)
3FINS167104	normal	red	25 (5 pairs / pad)
3FINS167106	large	pink	25 (5 pairs / pad)

Personal protective equipment



Medical protective equipment you can rely on!

With our protective equipment, we offer your staff and patients reliable protection against infections and injuries. Especially in areas such as decontamination / CSSD, high-quality protective equipment is essential.

- Nitrile protective gloves
- Full Face Visor



Nitrile protective gloves

Gloves for highest hygienic requirements

Our nitrile disposable gloves offer reliable protection for medical staff and patients. They meet the highest quality standards and are suitable both as protective and examination gloves. Special attention has been paid to ergonomics and quality so that you can rely on flexibility, resistance and comfort even when wearing them for a long time.

Our gloves comply with category III for personal protective equipment (PPE Regulation (EU) 2016/425).

Article No.	Description	Length	Size	Pack (pcs.)
3FPRO181302	colour: blue, material: nitrile, powder-free, fully textured surface, chlorinated inside, non-sterile	40 cm	S (6-7)	50
3FPRO181304	colour: blue, material: nitrile, powder-free, fully textured surface, chlorinated inside, non-sterile	40 cm	M (7-8)	50
3FPRO181306	colour: blue, material: nitrile, powder-free, fully textured surface, chlorinated inside, non-sterile	40 cm	L (8-9)	50
3FPRO181308	colour: blue, material: nitrile, powder-free, fully textured surface, chlorinated inside, non-sterile	40 cm	XL (9-10)	50



Full Face Visor (Cat. II)

Clear vision and protection in every situation

In terms of protection against liquids (drops and splashes), the visor meets the requirements of the standard EN 166 and complies with Regulation (EU) 2016/425 for personal protective equipment.

This protective visor is suitable for spectacle wearers. A face mask or FFP respirator can also be worn under the visor. The foam cushion and the flexible elastic band ensure pleasant comfort even when worn for long periods.

The visor does not protect against mechanical impact.

Article No.	Description	Pack (pcs.)
3FPRO181202	Full Face Visor, for single use	100



Cleaning accessories



Cleaning brushes and various accessories for efficient support of manual and machine cleaning

- Surface cleaning brushes
- Brushes for hollow instruments
- Cleaning brushes for endoscopes
- Various accessories



Stericlin® surface cleaning brushes

For manual (pre-) cleaning

The manual (pre-)cleaning of medical devices is regulated in legislation, standards and guidelines. The KRINKO/ BfArM recommendation states that, among other things, material-compatible equipment that is suitable for the medical device should be used in the pre-cleaning process. Stericlin® offers a wide range of suitable cleaning brushes for various applications and instrument types.

Article No.	Description	Brush head length (mm)	Length (mm)	Reprocessible	Pack (pcs.)
3FRIN550172	hard plastic bristles, plastic handle (green)	80 × 18 × 15	220	no	10
3FRIN550174	soft plastic bristles, plastic handle (yellow)	80 × 18 × 15	220	no	10
3FRIN550176	extra-hard plastic bristles, plastic handle (blue)	80 × 18 × 10	220	no	10



Article No.	Description	Brush head length (mm)	Length (mm)	Reprocessible	Pack (pcs.)
3FRIN550160	extra-hard plastic bristles, plastic handle	75	215	yes	5
3FRIN550162	soft plastic bristles, plastic handle	75	215	yes	5
3FRIN550164	extra-hard plastic bristles, plastic handle	75	235	yes	5
3FRIN550116	double-sided / soft plastic-bristles, plastic handle	25 / 35	175	yes	5
3FRIN550120	double-sided / medium-hard plastic bristles, plastic handle	25 / 35	175	yes	5
3FRIN550158	double-sided / extra-hard plastic bristles, plastic handle	30 / 40	175	yes	5
3FRIN550134	extra-hard plastic bristles, plastic handle	25 / 40	165	yes	5
3FRIN550136	stainless steel bristles, plastic handle *	40	178	no	5
3FRIN550166	brass bristles, plastic handle *	40	178	no	5
3FRIN550168	plastic bristles, plastic handle *	40	178	no	5

* For cleaning of work surfaces only. Not intended for reprocessing of instruments. Therefore not a medical device.

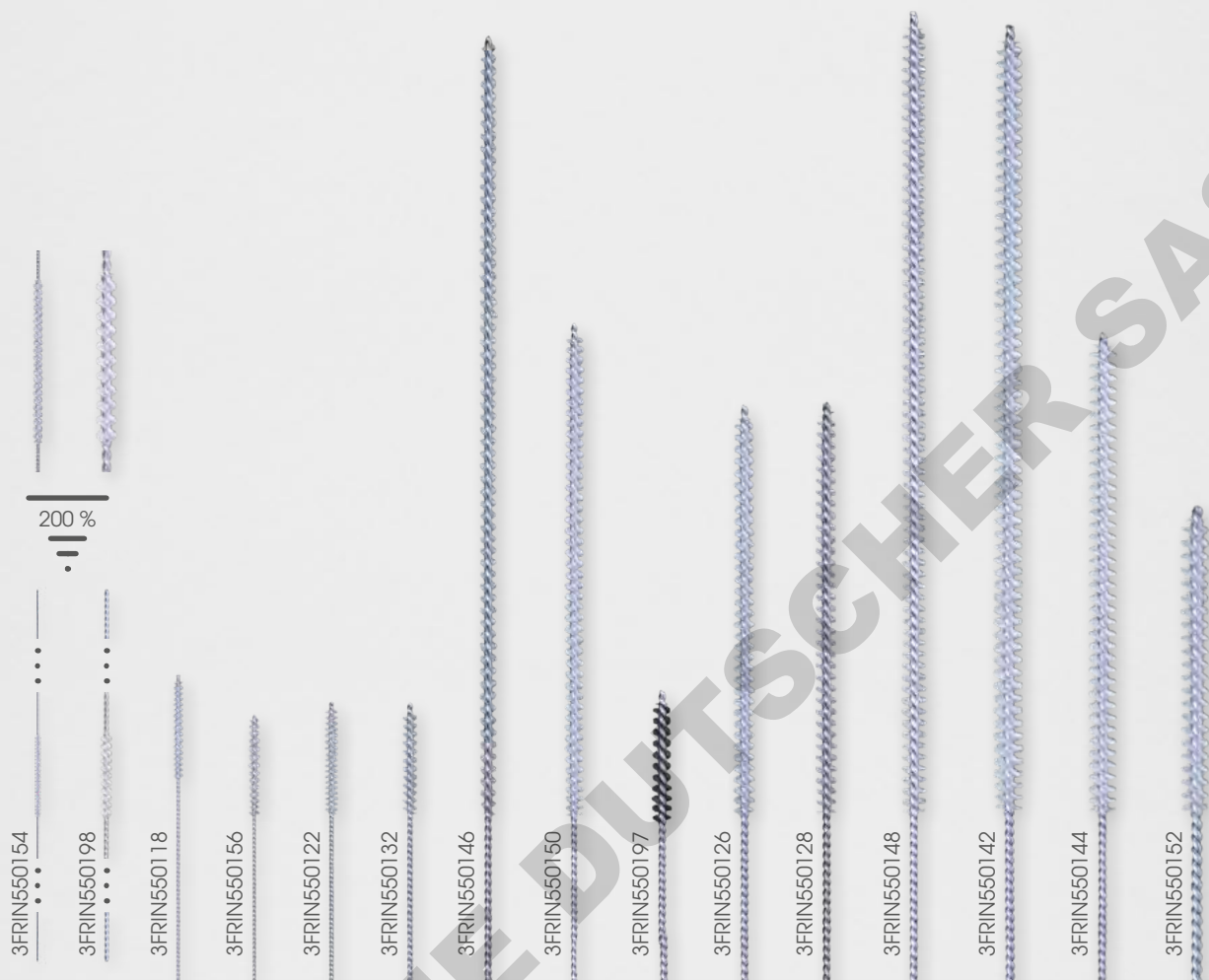

Stericlin® brushes for hollow instruments

For manual (pre-) cleaning

The manual (pre-)cleaning of medical devices is regulated in legislation, standards and guidelines. The KRINKO/ BfArM recommendation states that, among other things, suitable, material-compatible agents that are suitable for the medical device should be used in the pre-cleaning process. Stericlin® offers a wide range of suitable cleaning brushes for various applications and instrument types.

All Stericlin® cleaning brushes for hollow instruments have high-quality nylon bristles and will in future be supplied with round polished end pieces instead of protective tip caps. This meets customer requirements to facilitate the cleaning of curved lumens.

Article No.	Brush head Ø × L (mm)	Total length (mm)	Reprocessible	Properties	Pack (pcs.)
3FRIN550154	0,6 × 10	450	not recommended	Pull-through brush, stainless steel wire	5
3FRIN550198	1,4 × 10	450	not recommended	Pull-through brush, stainless steel wire	5
3FRIN550118	1,0 × 13	450	yes	Stainless steel wire	5
3FRIN550156	1,4 × 13	450	yes	Stainless steel wire	5
3FRIN550122	1,6 × 13	450	yes	Stainless steel wire	5
3FRIN550132	1,8 × 13	450	yes	Stainless steel wire	5
3FRIN550146	2,0 × 100	300	yes	Stainless steel wire	5

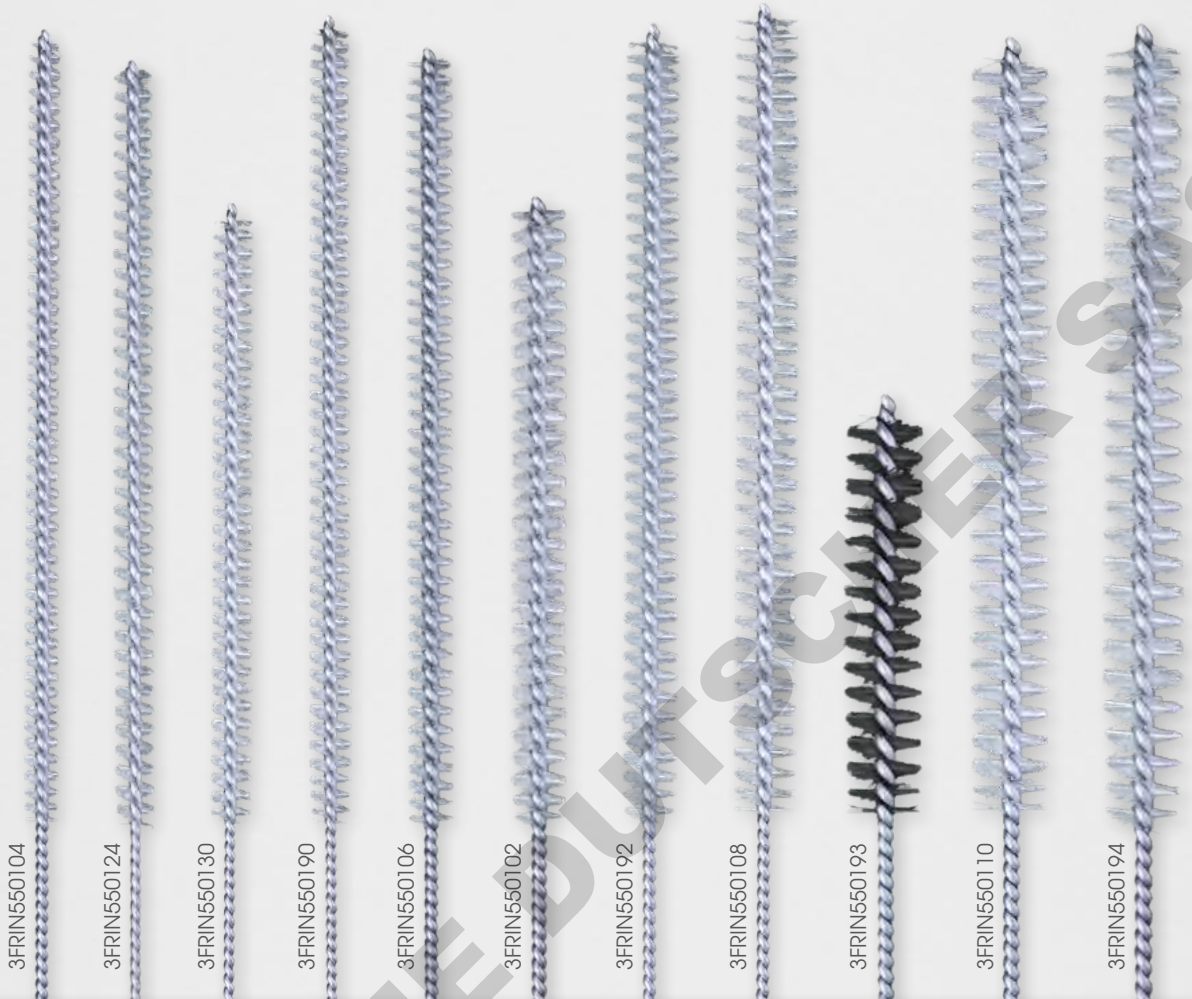

Article No.	Brush head Ø × L (mm)	Total length (mm)	Reprocessa- ble	Properties	Pack (pcs.)
3FRIN550150	2,0 × 60	350	yes	Stainless steel wire	5
3FRIN550197	2,2 × 60	410	yes	Stainless steel wire, black, harder bristles	2
3FRIN550126	2,5 × 50	300	yes	Stainless steel wire	5
3FRIN550128	2,5 × 50	610	yes	Stainless steel wire	5
3FRIN550148	3,0 × 100	300	yes	Stainless steel wire	5
3FRIN550142	3,5 × 100	250	yes	Stainless steel wire	5
3FRIN550144	3,5 × 60	265	yes	Stainless steel wire	5
3FRIN550152	3,5 × 35	500	yes	Stainless steel wire	5
3FRIN550104	4,0 × 100	300	yes	Stainless steel wire	5
3FRIN550124	5,0 × 100	300	yes	Stainless steel wire	5
3FRIN550130	5,0 × 80	405	yes	Stainless steel wire	5
3FRIN550190	5,0 × 100	650	yes	Stainless steel wire	5
3FRIN550106	6,0 × 100	300	yes	Stainless steel wire	5
3FRIN550102	7,0 × 80	350	yes	Stainless steel wire	5
3FRIN550192	7,0 × 100	650	yes	Stainless steel wire	5
3FRIN550108	8,0 × 100	300	yes	Stainless steel wire	5
3FRIN550193	10,0 × 50	460	ja	Stainless steel wire, black, harder bristles	2
3FRIN550110	10,0 × 100	300	yes	Stainless steel wire	5
3FRIN550194	10,0 × 100	650	yes	Stainless steel wire	5



Article No.	Brush head Ø × L (mm)	Total length (mm)	Reprocessible	Properties	Pack (pcs.)
3FRIN550196	12,0 × 100	650	yes	Stainless steel wire *	5
3FRIN550112	15,0 × 100	300	yes	Stainless steel wire *	5
3FRIN550138	20,0 × 150	450	yes	Stainless steel wire *	5
3FRIN550140	20,0 × 100	500	yes	Stainless steel wire *	5
3FRIN550141	40,0 × 60	500	yes	Stainless steel wire *	5

* Note see product description



Article No.	Brush head Ø × L (mm)	Total length (mm)	Reprocessible	Properties	Pack (pcs.)
3FRIN550178	3,0 × 20	600	no	Plastic shaft (white)	5
3FRIN550180	4,0 × 20	600	no	Plastic shaft (blue)	5
3FRIN550182	5,0 × 50	600	no	Plastic shaft (yellow)	5
3FRIN550184	7,0 × 50	600	no	Plastic shaft (white)	5
3FRIN550186	10,0 × 50	600	no	Plastic shaft (blue)	5
3FRIN550188	15,0 × 50	600	no	Plastic shaft (green)	5

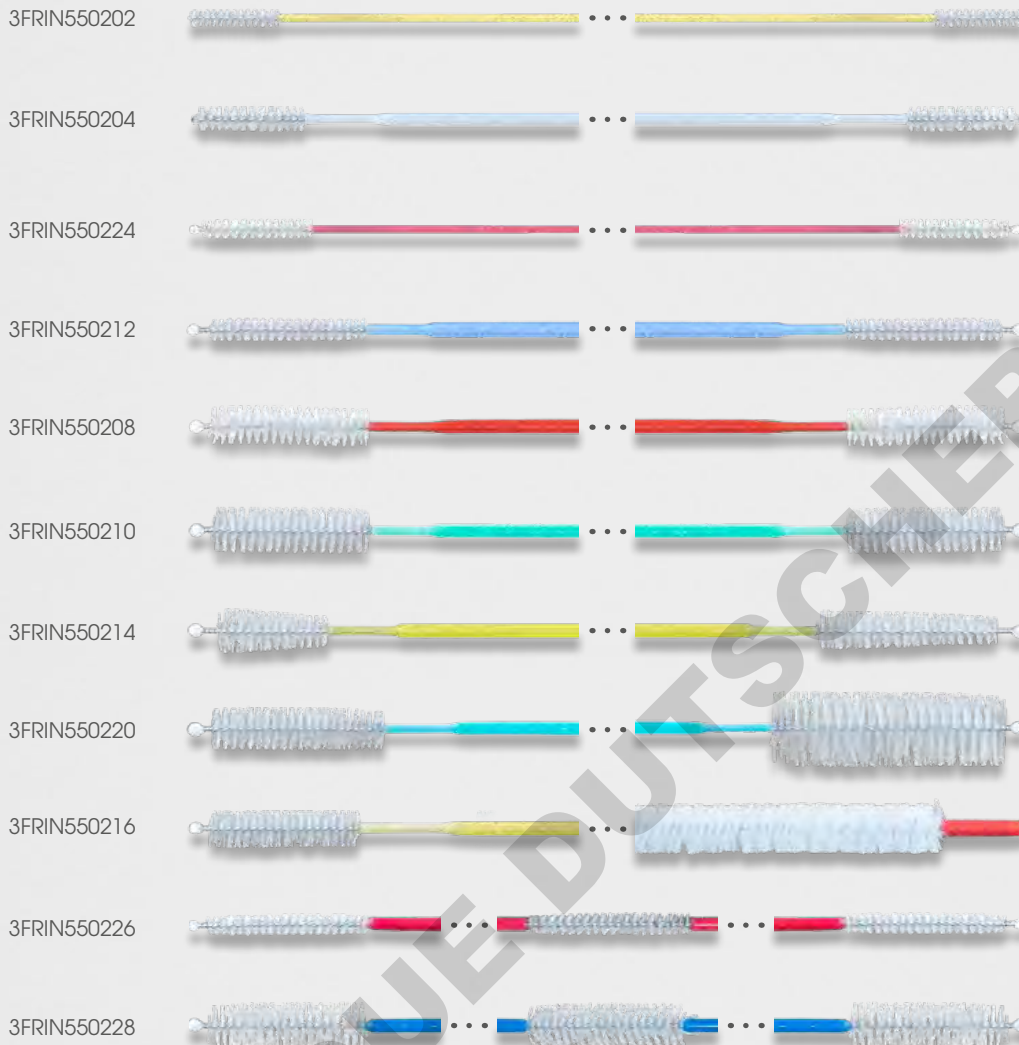

Cleaning brushes for endoscopes

For manual pre-cleaning

The manual (pre-)cleaning of flexible endoscopes and endoscopic accessories is required as standard in various guidelines and is an essential part of successful reprocessing. To avoid possible cross-contamination, it is not recommended to reuse endoscope cleaning brushes in the relevant literature. This is why our cleaning brushes for flexible endoscopes are only suitable for single use.

We offer a wide range of brushes with which the most common working channels and biopsy ports of various endoscope types can be pre-cleaned prior to mechanical reprocessing.

To achieve an ideal cleaning result, but at the same time prevent scratching of sensitive canals, the brushes are fitted with a plastic ball head and have medium-hard nylon bristles. In addition, all brushes have two bristle heads.



3FRIN550218



3FRIN550206



3FRIN550222



3FRIN550116



Article No.	Brush head Ø (mm)	Total length (mm)	Properties	Pack (pcs.)
3FRIN550202	2,0	1000	Colour: yellow	50
3FRIN550204	3,0	1000	Colour: white	50
3FRIN550224	2,5	2300	Colour: red	50
3FRIN550212	3,0	2300	Colour: blue	50
3FRIN550208	5,0	2300	Colour: red	50
3FRIN550210	6,0	2300	Colour: green	50
3FRIN550214	3,0-5,0 / 4,0-6,0	2300	Colour: yellow	50
3FRIN550220	5,5/10	2300	Colour: turquoise	50
3FRIN550216	5,0	2650	With 280 mm pipe cleaner, colour: yellow	50
3FRIN550226	3,0	2500	2 ends + 1 centered, including plastic tip, colour: red	50
3FRIN550228	6,0	2500	2 ends + 1 centered, including plastic tip, colour: blue	50
3FRIN550218	5,2/11	156	Valve cleaning brush, colour: red	100
3FRIN550206	6,5; 5,2/11	2570 156	Set contents: Cleaning brush, colour: blue; Valve cleaning brush, colour: red	50
3FRIN550222	5,0; 5,2/11	2300 156	Set contents: Cleaning brush, colour: red; Valve cleaning brush, colour: red	50
3FRIN550116	Brush head length: 25 / 35	175	double-sided / soft plastic-bristles, plastic handle	5



Stericlin® holders for non self-locking bone forceps and specula

For efficient assistance with machine cleaning

The cleaning and disinfection of forceps, non-demountable instruments with ring handles, specula and other non-self-retaining instruments is a particular challenge in critical areas such as joints or mouth parts. By maximising the area cleaned, the stericlin® holder is an effective aid for successful reprocessing.

Article No.	Description	Size (mm)	Pack (pcs.)
3FEDS844100	Holders for non-autostop bone rongeurs and specula, rust-free stainless steel with silicone padding, colour: white	40	1
3FEDS844108	Holders for non-autostop bone rongeurs and specula, rust-free stainless steel with silicone padding, colour: yellow	50	1
3FEDS844106	Holders for non-autostop bone rongeurs and specula, rust-free stainless steel with silicone padding, colour: blue	60	1
3FEDS844102	Holders for non-autostop bone rongeurs and specula, rust-free stainless steel with silicone padding, colour: red	70	1
3FEDS844110	Holders for non-autostop bone rongeurs and specula, rust-free stainless steel with silicone padding, colour: green	80	1
3FEDS844104	Holders for instruments with ring handle, stainless steel		1



3FSZB790111



3FRIN556105

3FRIN556109

3FRIN556107

3FRIN556111



3FRIN556120

3FRIN556125

Stericlin® cleaning accessories

For the efficient facilitation of mechanical cleaning

Stericlin® Hydro Soak Sets assist with the transport, storage and hydration of distal ends of laparoscopic instruments and EndoWrist® arms.

Our cleaning pads are versatile due to their material composition and perfectly suited for sharpening, polishing and cleaning steel, stainless steel and aluminium.

The steriGLIN® anti-fog cloth prevents lenses and face shields from fogging up due to moisture and sweat. It can be used several times and provides a lint-free, scratch-free, smear-free, long-lasting protective coating due to nanoparticles.

Article No.	Description	Pack (pcs.)
3FRIN556105	Stericlin® Hydro Soak Set with open lid, for transport, storage and hydration of distal ends of laparoscopic instruments and EndoWrist® arms, for single use, colour: green	20
3FRIN556109	Stericlin® Hydro Soak Set with closed lid, for transport, storage, as well as for keeping instruments and surgical robot arms moist, for single use, colour: blue	20
3FRIN556107	Stericlin® Hydro Soak Set with open lid, for transport, storage and hydration of bipolar forceps, for single use, colour: red	20
3FRIN556111	Stericlin® Hydro Soak Set with closed lid, for transport, storage, as well as for keeping bipolar forceps moist, for single use, colour: orange	20
3FRIN556120	Cleaning pads - rough, for sharpening, polishing, cleaning, colour: brown, 150 x 100 mm	3
3FRIN556125	Cleaning pads - fine, for sharpening, polishing, cleaning, colour: grey, 150 x 100 mm	3
3FSZB790111	Stericlin® anti fog cloth	20



Indicator systems



Chemical indicators for monitoring the sterilisation process and to supplement the parametric process documentation

- Cleaning efficacy indicators and tests
- Bowie-Dick test systems
- BMS 1200 batch monitoring system
- Indicator strips Type 6 – Type 1



TOSI®

Routine monitoring and validation of cleaning efficacy of WD's according to EN ISO 15883

TOSI® test devices are simulating contaminated surgical instruments. The contamination is correlating to the practical situation. If a cleaning process cannot clean the TOSI® it is not efficient enough to clean blood contaminated instruments!

Function

- A pre-prepared test giving efficient and repeatable results
- Test soil correlated to human blood in actual practice
- Transparent cover to enable visual check
- The crevice simulates the joint of a surgical instrument
- Clips for a quick and reproducible fixation
- Distinction between chemical and mechanical cleaning problems

Evaluation

The TOSI® will not only give a yes/no answer for blood cleaning efficacy but will also give feedback regarding the cause of a problem.

Contaminated instruments are a hygiene risk and need to be rejected. Instruments need to be free of any residue!

Article No.	Description	Pack (pcs.)
3FRIN555105	TOSI® test device	12



3FRIN555110

3FRIN555115



TOSI®-LumCheck

Validation and routine monitoring of the cleaning efficacy of WD's or ultrasonic cleaners according to EN ISO 15883

TOSI®-LumCheck test specimens simulate contaminated hollow instruments. The soiling behaves in a practical manner. If a cleaning process cannot completely clean the TOSI®-LumCheck, it is not effective enough to completely remove blood as well!

Function

- Luer lock connector for easy attachment
- Test soil on stripe correlates to human blood in actual practice
- Dismountable device for visual check and process evaluation
- The device simulates cannulated surgical instruments

Two common ways to clean cannulated instruments

- Cleaning of cannulated instruments in washer-disinfectors:
Cannulated instruments are connected to the water supply in a special tray of the washer disinfector
- Cleaning of cannulated instruments in ultrasonic cleaner:
Cannulated instruments are reprocessed with the aid of ultrasonic energy.

Evaluation

TOSI®-LumCheck not only shows a yes/no result for the cleaning performance. In the event of cleaning problems, conclusions can also be drawn about possible causes.

Contaminated instruments are a hygiene risk and need to be rejected. Instruments need to be free of any residue!

Article No.	Description	Pack (pcs.)
3FRIN555110	TOSI®-LumCheck test device	1
3FRIN555115	TOSI®-LumCheck test strip	25



TOSI®-FlexiCheck

Validation and routine monitoring of the cleaning performance of WD-E's according to EN ISO 15883

TOSI®-FlexiCheck checks the performance of the machine and the cleaning chemicals. For reprocessing Flexible Endoscopes washers with channel irrigation systems are recommended. FlexiCheck is connected to this system and will simulate a single channel at one time.

Function

- Luer lock connector for easy attachment
- The device simulates a flexible endoscope channel
- Two separate test soils for demonstrating the removal of blood and polysaccharides
- Immediate result through visual control

Evaluation

Flexible endoscopes are often contaminated with mucus however blood is also a possible contaminant. TOSI-FlexiCheck combines 2 different test soils on one test strip: One is the standardised blood test soil and the second is a polysaccharide mixture.

Contaminated instruments are a hygiene risk and need to be rejected. Instruments need to be free of any residue!

Article No.	Description	Pack (pcs.)
3FRIN555120	TOSI®-FlexiCheck test device	1
3FRIN555125	TOSI®-FlexiCheck test strip	25
3FRIN555121	FlexiCheck adapter A (Wassenburg)	1
3FRIN555122	FlexiCheck adapter C (Olympus)	1



SonoCheck

Validating and monitoring the energy of ultrasonic baths according to AS/NZS 4187

SonoCheck is used to monitor the ultrasonic energy level during the cleaning of surgical instruments. SonoCheck is also used to measure the performance of the individual transducers during the functional test.

Function

- Detects sufficient energy for cavitation
- A pre-prepared test showing immediate result
- Colour change from green to yellow indicating a positive result
- Easy evaluation

Evaluation

The process of ultrasonic cleaning relies upon the occurrence of cavitation. This effect will trigger a chemical reaction in the SonoCheck changing its colour.

When the ultrasonic cleaner is supplying sufficient energy, SonoCheck will show a positive result within the recommended cycle time. Effects such as insufficient energy, overloading, water level and de-gassing will increase the time needed for the colour change. In the case of a major problem SonoCheck will not change at all.

Article No.	Description	Pack (pcs.)
3FRIN555130	SonoCheck	30



A colour change to blue-green on the swab indicates blood-protein residue



HemoCheck-S

Detection of blood-protein residue on surgical instruments and surfaces

HemoCheck-S is based on an enzymatic reaction also used in forensic science. Blood contains large quantity of peroxidases and can be detected in very small quantity. For routine monitoring and validation of cleaning efficacy according to EN ISO 15883.

Function

- Pre-prepared and user friendly
- Only test on the market with immediate result
- Enzymatic reaction will detect insoluble residue
- A color change to green indicates contamination of the tested instrument
- Detection already from 0.1 µg blood residue
- Detects blood residue on surfaces and instruments

Evaluation

Different than standard protein testing HemoCheck-S gives a 100% clear answer by blood being the best marker for a hygiene risk. A colour change to green on the swab indicates blood-protein residue on the tested area. A large amount of blood can discolor the entire test.

Contaminated instruments are a hygiene risk and need to be rejected. Instruments need to be free of any residue!

Article No.	Description	Pack (pcs.)
3FRIN555150	HemoCheck-S	12



Colour change to blue indicates a contaminated surface



Pyromol-Test

Detection of protein residue on instruments and surfaces

Pyromol-Test is based on a dye binding method which is also used in clinical chemistry. Blood contains large amount of protein which can be detected at a low level. For routine monitoring and validation of cleaning efficacy according to EN ISO 15883.

Function

- Easy to use test kit
- Quick detection of insoluble protein residue
- Colour change to blue indicates a contaminated surface
- Dye binding method for a detection limit of 1µg
- No interference with glutaraldehyde or peracetic acid

Evaluation

The Pyromol-Test is used for the detection of protein residue where HemoCheck-S cannot be used, for example, when the protein source is other than blood. A blue spot on the swab indicates protein residue on the tested surface. A large amount of protein can discolor the entire test.

Contaminated instruments are a hygiene risk and need to be rejected. Instruments need to be free of any residue!

Article No.	Description	Pack (pcs.)
3FRIN555140	Pyromol-Test	20



Colour change to blue indicates a contaminated channel



Pyromol-E-Test

Detection of protein residue in endoscope channels

Pyromol-Test is based on a dye binding method which is also used in clinical chemistry. Contamination in an endoscope contains protein which can be detected at a low level. For routine monitoring and validation of cleaning efficacy according to EN ISO 15883.

Function

- Easy to use test kit
- Quick detection of insoluble protein residue
- Colour change to blue indicates a contaminated channel
- Dye binding method for a detection limit of 1 µg
- No interference with glutaraldehyde or peracetic acid

Evaluation

Pyromol-E will detect protein residue after manual or automated reprocessing. A blue spot on the swab indicates protein residue in the tested channel. A large amount of protein can discolor the entire test.

Contaminated instruments are a hygiene risk and need to be rejected. Instruments need to be free of any residue!

Article No.	Ø in mm	Length	Pack (pcs.)
3FRIN555141	1,0	2 m	6
3FRIN555142	1,7	2 m	6
3FRIN555143	2,8	2 m	6
3FRIN555144	3,8	2 m	6
3FRIN555145	5,0	2 m	6



Purple colour change indicates residual water



HydroCheck-E

Test for residual water in flexible endoscopes

HydroCheck-E can detect a very small amount of residual water inside an endoscope channel to avoid recontamination during storage.

Function

- Easy to use test kit
- Verify the dryness of flexible endoscope channels
- Purple colour change indicates residual water in the tested channel
- Detection limit of 0.05 µl residual water
- Immediate result, no incubation required

Evaluation

A swab is used to sample any residual water from the endoscope channel and is then tested with the HydroCheck-E. A purple spot on the swab indicates residual water in the tested channel.

Article No.	Description	Pack (pcs.)
3FRIN555172	Ø 1,7 mm / length 2,3 m	6
3FRIN555173	Ø 2,8 mm / length 2,3 m	6
3FRIN555174	Ø 3,8 mm / length 2,3 m	6
3FRIN555175	Ø 5,0 mm / length 2,3 m	6



EndoSwab

Highly absorbent cleaning and monitoring brushes for flexible endoscopes

Endoswabs are based on a highly absorbent polyester fibre. Endoswabs will absorb and collect residue out of the channel, while nylon fibres glide through mucus residue inside the channel.

- High cleaning efficacy for endoscope channels
- Available in 4 sizes: 1,7 mm | 2,8 mm | 3,8 mm | 5,0 mm
- Up to 2,3 m long
- Compatible with Pyromol-E and HydroCheck-E

Endoswabs can be used for the manual cleaning step according to the flexible endoscope cleaning procedure and for testing the cleanliness of the channels.

Article No.	Description	Size	Pack (pcs.)
3FRIN555181	Endoswab	Ø 1,7 mm / length 2,3 m	10
3FRIN555182	Endoswab	Ø 2,8 mm / length 2,3 m	10
3FRIN555183	Endoswab	Ø 3,8 mm / length 2,3 m	10
3FRIN555184	Endoswab	Ø 5,0 mm / length 2,3 m	10
3FRIN555188	Robotic Arm Swab, high performance test brush for robotic arms	Ø 1,38 mm / length 0,75 m	10
3FRIN555190	High performance aluminium test brush	Ø 1,0 mm / length 14,5 cm	12



pH-Check

For identifying alkaline residues

The pH-Check is based on an indicator solution. Alkaline residues from cleaners or hard water lead to a color change to red.

Function

- Easy to use test kit
- Instrument surface is wiped with a moistened swab
- Quick detection of detergents or hard water
- Color change to red indicates alkaline residues

Evaluation

A red discoloration on the test swab indicates alkaline residues on the tested surface.

Contaminated instruments are a hygiene risk and need to be rejected. Instruments need to be free of any residue!

Artikel-Nr.	Beschreibung	Inhalt (Stück)
3FRIN555160	pH-Check	24



Bowie-Dick helix test

Process challenge device made of aluminium - EN ISO 11140-4

Our steriCLIN® Bowie-Dick helix test corresponds to the standard EN ISO 11140-4 and checks your steriliser objectively on air extraction and steam penetration. The process challenge device (PCD) made of aluminium with integrated plastic helix can be used for 250 sterilisation cycles.

The handling convinces with simplicity and speed:

- Place indicator strip in the capsule
- Screw the capsule on the PCD
- Run the Bowie-Dick program
- Remove the test strip
- Check result

At full steam penetration, the indicator changes colour from blue to pink. An incomplete colour change indicates a malfunction with the steriliser.

SteriCLIN® indicators contain no heavy metals or toxic substances. After the initial colour change, the colour of the indicator no longer changes. This gives you completely secure documentation.

Article No.	Description	Pack (pcs.)
3FSKS613102	Bowie-Dick-Helix Test	250



3FSKS611102



3FSKS610506



3FSKS610502



Original sheet



Test passed



Test passed



Test failed



Test failed



Test failed

Representation for your information, colours may vary.
Original can be requested via postal service

Kitemark test seal of the British Standards Institution (BSI)

Bowie-Dick single use test pack

Easy handling of the steam penetration tests – EN ISO 11140-4

Our stericlin® Bowie-Dick single use test pack allows the daily function control and quality assurance of your steam steriliser.

The ease of use convinces:

- Place test pack in the steriliser
- Run the Bowie-Dick program
- Remove the test sheet
- Check result

Stericlin® indicators contain no heavy metals or toxins. After the initial colour change, the colour of the indicator no longer changes. This gives you completely secure documentation.

Kitemark of the British Standards Institution (BSI)

The renowned, internationally recognised test institute confirms compliance of our Bowie-Dick single use test pack with the strict standard requirements of EN ISO 11140-4.

With the Lean Pack we offer an ecological and economical alternative for the daily Bowie-Dick test.

The Prime Pack contains a firmer indicator card with stronger colour printing and more paper layers. In addition, unlike the tubular bag of the Lean-Pack, a folding box is used as outer packaging.

Article No.	Description	Pack (pcs.)
3FSKS611102	Bowie-Dick-single use test pack (Lean-Pack)	40
3FSKS610506	Bowie-Dick-single use test pack (Prime-Pack)	50
3FSKS610502	Bowie-Dick-single use test pack (Chinese)	28



BMS 1200 Batch Monitoring System

Batch monitoring system according to requirements of EN 867-5

Our steriGLIN® Batch Monitoring System meets the requirements of EN 867-5 and is specially designed for batch control of the sterilisation load. The process challenge device (PCD) made of aluminium simulates hard to sterilise hollow instruments. The so-called "helix" is located inside and at the end the chemical indicator is placed in a screw cap made of plastic. The PCD may be reused.

The handling of the steriGLIN® Batch Monitoring System is easy as well as time and space efficient:

- Place indicator strip in the capsule
- Screw the capsule on the PCD
- Run sterilisation programme
- Remove the test strip
- Check result

With full steam penetration, the indicator changes colour from blue to pink, incomplete colour change indicates a malfunction of the steriliser.

SteriGLIN® indicators contain no heavy metals or toxic substances. After the initial colour change, the colour of the indicator no longer changes. This gives you absolute security documentation.

The use of batch control systems to monitor steam penetration is recommended by the Commission for Hospital Hygiene and Infection Prevention at the Robert Koch Institute (RKI), the Federal Institute for Drugs and Medical Devices (BfArM), the German Society for Hospital Hygiene and health authorities.

Article No.	Description	Pack (pcs.)
3FSKS630106	Starter Kit: 1 PCD, 2 capsules, 250 indicator strips	1
3FSKS630102	Indicator strips (incl. 1 capsule), size: 76,5 x 5,5 mm	250



Indicator strips Type 6 (STEAM)

Emulating indicators according to EN ISO 11140-1

Our stericlin® indicator strips Type 6 check your sterilisation processes for sufficient steam exposure (steam, temperature and time) in the interior of trays or other selected locations. Only upon compliance with all parameters a correct colour change does appear. Uncompromising error contrast disclosed. It can be checked independently with different sterile barrier systems within a batch.

The indicator strips are easy to use:

- Place at the desired locations in the loading area (in see-through packaging, wrapping materials, containers, etc.)
- Run sterilisation programme
- Remove indicator strip
- Check result

With sufficient steam exposure, the indicator changes colour from blue to pink, incomplete colour change indicates a malfunction of the steriliser.

The stericlin® indicator strips meet the requirements of EN ISO 11140-1 for the designated Type 6 (Emulators). For both performance requirements, we ensure a high precision resistometer for testing purposes. Therefore, we guarantee standard compliance and absolute consistency of this product.

Stericlin® indicators contain no heavy metals or toxic substances. After the initial colour change, the colour of the indicator no longer changes. This gives you absolute security documentation.

Article No.	Description	Size	Pack (pcs.)
3FSKS645102	134 °C - 3,5 min.	80 x 30 mm	500
3FSKS645104	132 °C - 4 min.	80 x 30 mm	500
3FSKS645105	134°C - 4 min.	80 x 30 mm	500
3FSKS645106	134 °C - 5,3 min.	80 x 30 mm	500
3FSKS645108	134 °C - 7 min.	80 x 30 mm	500
3FSKS645112	134 °C - 18 min.	80 x 30 mm	500



Indicator strips Type 5 (STEAM)

Integrated indicators according to EN ISO 11140-1

Our stericlin® indicator strips Type 5 check your sterilisation processes for sufficient steam exposure (steam, temperature and time) in the interior of trays or other selected locations. The specifications for this arise from the behaviour of biological indicators. It can be checked independently with different sterile barrier systems within a batch. The indicator Type 5 is particularly advantageous if you sterilise your reprocessed medical products at both 121 °C and 134 °C.

The indicator strips are easy to use:

- Place at the desired locations in the loading area (in see-through packaging, wrapping materials, containers, etc.)
- Perform sterilisation program
- Remove indicator strip
- Check result

With sufficient steam exposure, the indicator changes colour from blue to pink, incomplete colour change means a malfunction of the steriliser.

The stericlin® indicator strips meet the requirements of EN ISO 11140-1 for the designated Type 5 (Integrators). For both performance requirements, we ensure a high precision resistometer for testing purposes. Therefore, we guarantee standard compliance and absolute consistency of this product.

Stericlin® indicators contain no heavy metals or toxic substances. After the initial colour change, the colour of the indicator no longer changes. This gives you absolute security documentation.

Article No.	Description	Size	Pack (pcs.)
3FSKS646102	134 °C/121 °C	80 × 30 mm	500



Indicator strips Type 4 (STEAM)

Multi-parameter indicators according to EN ISO 11140-1

Our stericlin® indicator strips Type 4 check your sterilisation processes for the exposure of steam, temperature and time in the interior of trays or other selected locations. Only upon compliance with all parameters a correct colour change does appear. Uncompromising error contrast disclosed. It can be checked independently with different sterile barrier systems within a batch.

The indicator strips are easy to use:

- Place at the desired locations in the loading area (in see-through packaging, wrapping materials, containers, etc.)
- Perform sterilisation program
- Remove indicator strip
- Check result

With sufficient steam exposure, the indicator changes colour from blue to pink, incomplete colour change indicates a malfunction of the steriliser.

The stericlin® indicator strips meet the requirements of EN ISO 11140-1 for the designated Type 4 (Multi-parameter indicators). For both performance requirements, we ensure a high precision resistometer for testing purposes. Therefore, we guarantee standard compliance and absolute consistency of this product.

Stericlin® indicators contain no heavy metals or toxic substances. After the initial colour change, the colour of the indicator no longer changes. This gives you absolute security documentation.

Article No.	Description	Size	Pack (pcs.)
3FSKS647102	134 °C – 3,5 min.	80 x 30 mm	500
3FSKS647106	134 °C – 5,3 min. / 121 °C – 15 min.	80 x 30 mm	500



Indicator strips Type 1 (STEAM)

Process indicators according to EN ISO 11140-1

SteriClin® indicator strips Type 1 enable easy sterilisation monitoring and documentation. The indicator strips are available for STEAM and FORM-sterilisation. As process indicators, they serve as a distinction between sterilised and non-sterilised products.

Labelling fields for batch, steriliser, content, expiration date, OK/fail and a signature field are printed on the steriClin® indicator strips Type 1.

The steriClin® indicator strips meet the requirements of EN ISO 11140-1 for the designated Type 1 (Process indicators).

Article No.	Description	Size	Pack (pcs.)
3FSKS650102	STEAM, self-adhesive	150 x 30 mm	250
3FSKS650104	STEAM	150 x 30 mm	250

APPLICATION INFORMATION
SEE-THROUGH PACKAGING

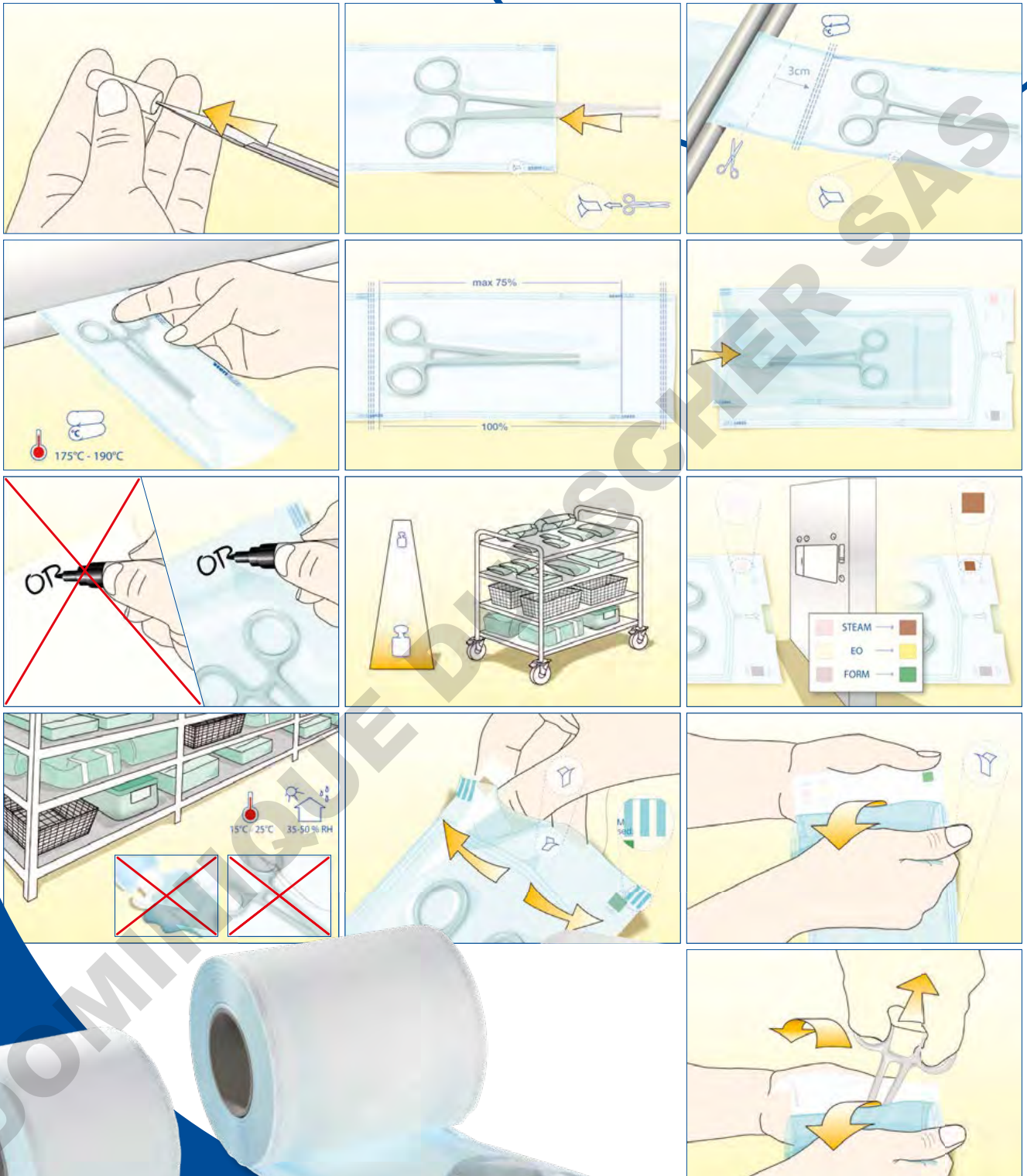



See-through packaging



The right material combination for each application

- See-through packaging made of paper and film
- See-through packaging made of non-woven and film
- See-through packaging made of PP non-woven (White Line) and film
- See-through packaging made of DuPont™ Tyvek® and film



See-through pouches flat made of paper and film

Safe sterilisation – different sizes – EN ISO 11607

Stericlin® see-through pouches meet the requirements of EN ISO 11607 and DIN 868-5 and are the universal packaging system for sterilisation. So that you can pack almost all light and medium-heavy instruments. The sterilisation-resistant 70 g/m² heavy-duty paper creates an effective barrier against germs, but is also permeable to air, steam and sterilisation gases. Three indicators are printed outside the filling area: STEAM, EO and FORM.

Convincing quality

Our Stericlin® see-through packaging made of 70 g/m² paper stands out against market regular 60 g/m² paper packaging in terms of quality, strength and safety margins.

Article No.	Size in cm (width × length)	Pack (pcs.)
3FKFB210102	5,5 × 20	2000
3FKFB210104	5,5 × 25	2000
3FKFB210106	7,5 × 15	2000
3FKFB210108	7,5 × 20	2000
3FKFB210110	7,5 × 25	2000
3FKFB210112	7,5 × 30	2000
3FKFB210114	10 × 15	2000
3FKFB210116	10 × 20	2000
3FKFB210118	10 × 25	2000
3FKFB210120	10 × 30	2000
3FKFB210122	10 × 36	1000
3FKFB210124	10 × 40	1000
3FKFB210126	10 × 52	1000
3FKFB210128	12,5 × 25	2000
3FKFB210130	12,5 × 30	2000
3FKFB210131	12,5 × 35	1000
3FKFB210132	12,5 × 40	1000
3FKFB210134	12,5 × 52	1000
3FKFB210136	15 × 20	1000
3FKFB210138	15 × 27	1000
3FKFB210140	15 × 30	1000
3FKFB210142	15 × 38	1000

Article No.	Size in cm (width × length)	Pack (pcs.)
3FKFB210143	15 × 50	1000
3FKFB210144	15 × 61	1000
3FKFB210146	16 × 22	1000
3FKFB210148	20 × 27	1000
3FKFB210150	20 × 40	1000
3FKFB210152	20 × 61	1000
3FKFB210154	21 × 33	1000
3FKFB210156	22 × 30	1000
3FKFB210158	22 × 35	1000
3FKFB210160	22 × 42	1000
3FKFB210162	25 × 38	1000
3FKFB210164	25 × 40	1000
3FKFB210166	25 × 42	1000
3FKFB210168	25 × 48	500
3FKFB210170	27 × 45	500
3FKFB210172	30 × 42	500
3FKFB210174	30 × 57	500
3FKFB210176	32 × 50	500
3FKFB210178	36 × 58	500
3FKFB210180	38 × 50	500
3FKFB210182	42 × 50	500
3FKFB210184	42 × 61	500

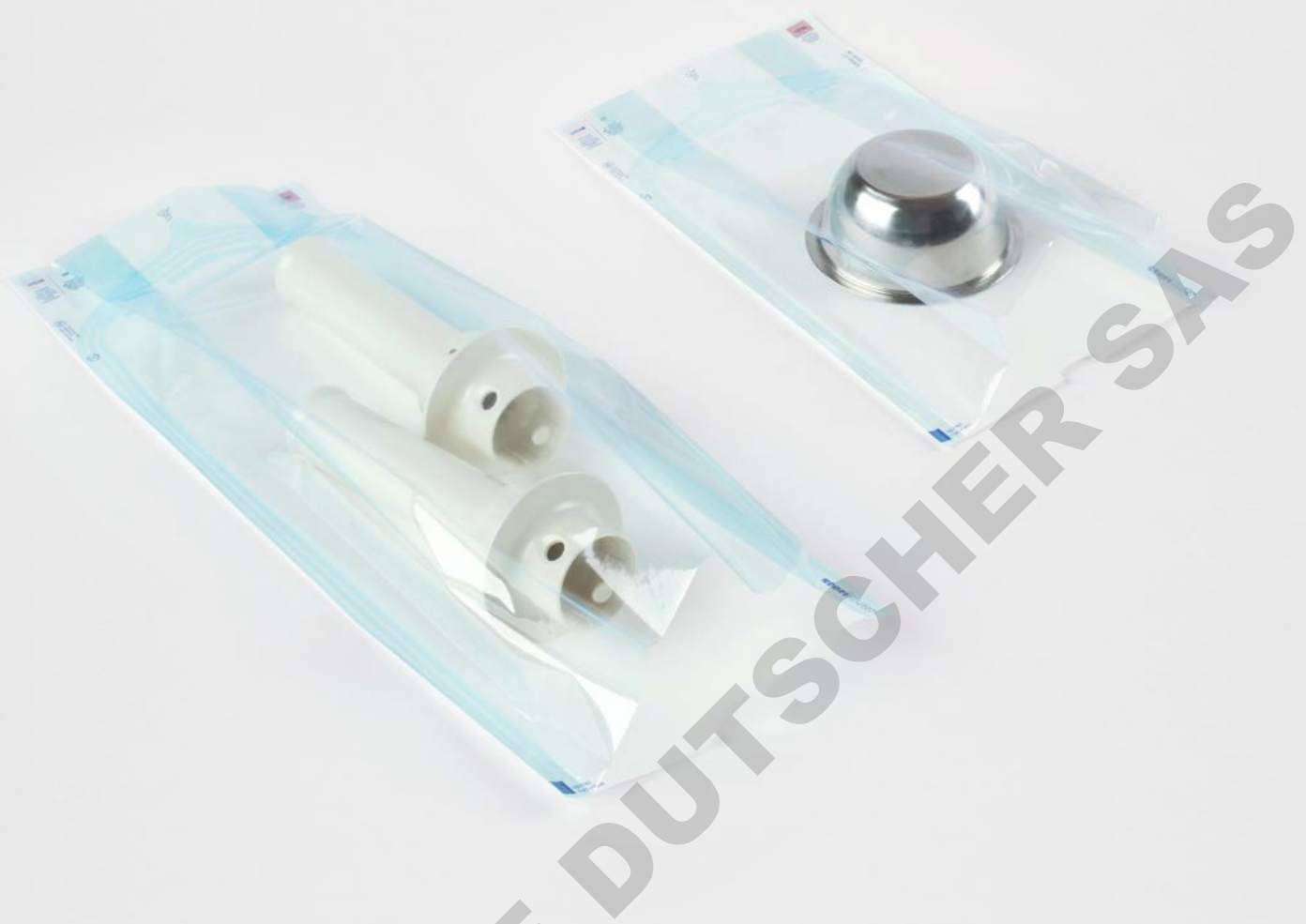

See-through pouches gusseted made of paper and film

Safe sterilisation – different sizes – EN ISO 11607

Stericlin® see-through pouches meet the requirements of EN ISO 11607 and DIN 868-5 and are the universal packaging system for sterilisation. So that you can pack almost all light and medium-heavy instruments. The sterilisation-resistant 70 g/m² heavy-duty paper creates an effective barrier against germs, but is also permeable to air, steam and sterilisation gases. Three indicators are printed outside the filling area: STEAM, EO and FORM.

Convincing quality

Our stericlin® see-through packaging made of 70 g/m² paper stands out against market regular 60 g/m² paper packaging in terms of quality, strength and safety margins.

Article No.	Size in cm (width × gusset × length)	Pack (pcs.)
3FKSB220102	10 × 5 × 30	2000
3FKSB220104	10 × 5 × 40	2000
3FKSB220106	15 × 5 × 28	1000
3FKSB220108	15 × 5 × 40	1000
3FKSB220110	20 × 5 × 40	1000
3FKSB220112	20 × 5 × 48	500
3FKSB220114	25 × 6,5 × 48	500
3FKSB220116	30 × 6,5 × 61	500
3FKSB220118	41 × 6,5 × 61	500



See-through reels flat made of paper and film

Safe sterilisation – different sizes – EN ISO 11607

Stericlin® see-through reels meet the requirements of EN ISO 11607 and DIN 868-5 and are the universal packaging system for sterilisation. So that you can pack almost all light and medium-heavy instruments. The sterilisation-resistant 70 g/m² heavy-duty paper creates an effective barrier against germs, but is also permeable to air, steam and sterilisation gases. Three indicators are printed outside the filling area: STEAM, EO and FORM.

Convincing quality

Our stericlin® see-through packaging made of 70 g/m² paper stands out against market regular 60 g/m² paper packaging in terms of quality, strength and safety margins.

Article No.	Width in cm	Length	Pack (reels)
3FKFS230102	5	200 m	6
3FKFS230104	7,5	200 m	4
3FKFS230106	10	200 m	3
3FKFS230108	12,5	200 m	2
3FKFS230110	15	200 m	2
3FKFS230112	20	200 m	2
3FKFS230114	25	200 m	2
3FKFS230116	30	200 m	1
3FKFS230117	35	200 m	1
3FKFS230118	38	200 m	1
3FKFS230119	40	200 m	1
3FKFS230120	42	200 m	1
3FKFS230122	50	200 m	1

Article No.	Width in cm	Length	Pack (reels)
3FKFS230302	5	100 m	3
3FKFS230304	7,5	100 m	2
3FKFS230306	10	100 m	1
3FKFS230308	12,5	100 m	4
3FKFS230310	15	100 m	1
3FKFS230312	20	100 m	2
3FKFS230314	25	100 m	2
3FKFS230316	30	100 m	1
3FKFS230320	42	100 m	1



See-through reels gusseted made of paper and film

Safe sterilisation – different sizes – EN ISO 11607

SteriClin® see-through reels meet the requirements of EN ISO 11607 and DIN 868-5 and are the universal packaging system for sterilisation. So that you can pack almost all light and medium-heavy instruments. The sterilisation-resistant 70 g/m² heavy-duty paper creates an effective barrier against germs, but is also permeable to air, steam and sterilisation gases. Three indicators are printed outside the filling area: STEAM, EO and FORM.

Convincing quality

Our steriClin® see-through packaging made of 70 g/m² paper stands out against market regular 60 g/m² paper packaging in terms of quality, strength and safety margins.

Article No.	Size in cm (width × gusset)	Length	Pack (reels)
3FKSS230204	7,5 × 2,5	100 m	4
3FKSS230206	10 × 5	100 m	3
3FKSS230210	15 × 5	100 m	2
3FKSS230212	20 × 5	100 m	2
3FKSS230214	25 × 6,5	100 m	2
3FKSS230216	30 × 6,5	100 m	1
3FKSS230218	38 × 8,0	100 m	1
3FKSS230220	42 × 8,0	100 m	1



See-through packaging made of non-woven and film

Ideal for large-volume goods – high steam permeability – EN ISO 11607

This stericlín® see-through packaging made of 56 g/m² non-woven with sealed-laminated film. Three indicators for STEAM, EO and FORM sterilisation are printed outside the filling area. Our system combines the sterilisation-technical advantages of flexible packaging (non-woven fabric) with the facilitation of see-through packaging. The high air and steam permeability allows the use of large and absorbent loads. Due to mechanical strength, heavy instruments can also be safely packaged. Stericlín® see-through packaging meets the requirements of DIN EN ISO 11607 and EN 868-5.

Article No.	Type	Size (width × length)	Pack
3FKFB240105	Pouch	27 × 36 cm	500 pcs.
3FKFB240110	Pouch	32 × 45 cm	500 pcs.
3FKFB240115	Pouch	40 × 52 cm	250 pcs.
3FKFB240120	Pouch	50 × 60 cm	250 pcs.
3FKFB240125	Pouch	57 × 72 cm	250 pcs.
3FKFB240130	Pouch	62 × 72 cm	250 pcs.
3FKFS240212	Reel	20 cm × 100 m	2 reels
3FKFS240220	Reel	42 cm × 100 m	1 reel

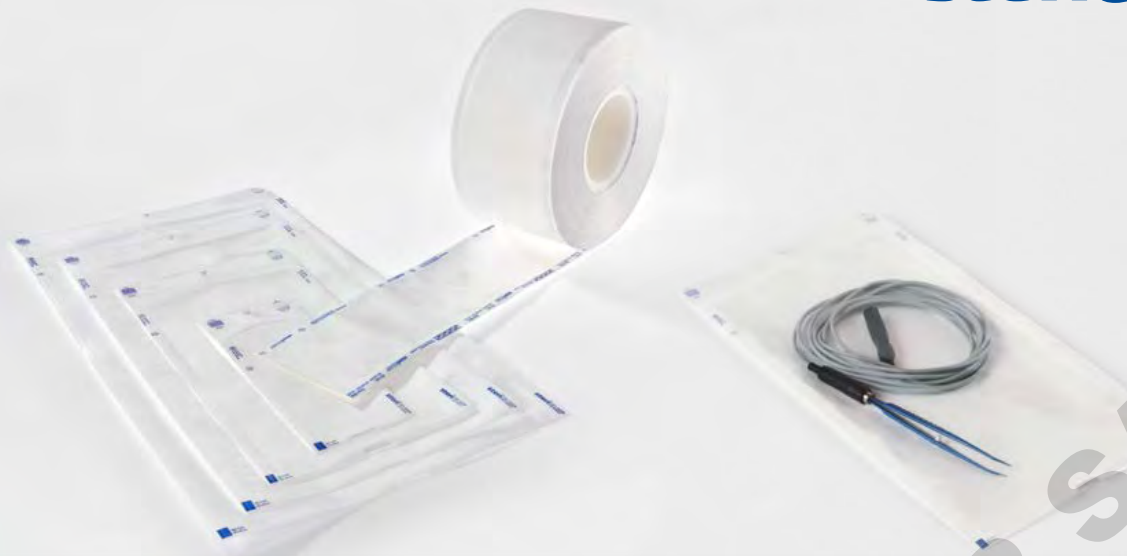

See-through packaging made of DuPont™ Tyvek® and film

Ideal for heat-sensitive instruments – fibre-free peeling – EN ISO 11607

The quality of steriCLIN® see-through packaging made of Tyvek® and composite film is decisively influenced by the selected material. Therefore, we use only the strongest medical Tyvek®: Type 1073 B with a base weight of 75 g/m² and Tyvek 2FS with a base weight of 59,5 g/m².

Tyvek® and the composite film used are ideal for VH2O2 (plasma)-, EO-, FORM- and irradiation sterilisation. Two indicators for the VH2O2 (plasma)- and EO sterilisation are printed outside the filling area. With the more economical 2FS packaging, only the VH2O2 indicator is imprinted and, if required, you can attach an additional steriCLIN® EO, FORM or irradiation indicator onto or inside the packaging.

The steriCLIN® sterile barrier system is first choice in gas sterilisation, as Tyvek® and the composite film hardly absorb the toxic gases and enable residual gases to be far below specified limits. SteriCLIN® see-through packaging meets the requirements of EN ISO 11607 and EN 868-9.

Article No.	Type	Material	Indicator	Size (width × length)	Pack
3FKFB250105	Pouch	Tyvek® and film	VH2O2 (plasma) + EO	7,5 × 20 cm	1000 pcs.
3FKFB250110	Pouch	Tyvek® and film	VH2O2 (plasma) + EO	10 × 27 cm	500 pcs.
3FKFB250115	Pouch	Tyvek® and film	VH2O2 (plasma) + EO	15 × 30 cm	500 pcs.
3FKFB250120	Pouch	Tyvek® and film	VH2O2 (plasma) + EO	20 × 40 cm	500 pcs.
3FKFB250125	Pouch	Tyvek® and film	VH2O2 (plasma) + EO	25 × 48 cm	500 pcs.
3FKFS250204	Reel	Tyvek® and film	VH2O2 (plasma) + EO	7,5 cm × 100 m	2 reels
3FKFS250206	Reel	Tyvek® and film	VH2O2 (plasma) + EO	10 cm × 100 m	2 reels
3FKFS250210	Reel	Tyvek® and film	VH2O2 (plasma) + EO	15 cm × 100 m	1 reel
3FKFS250212	Reel	Tyvek® and film	VH2O2 (plasma) + EO	20 cm × 100 m	1 reel
3FKFS250214	Reel	Tyvek® and film	VH2O2 (plasma) + EO	25 cm × 100 m	1 reel
3FKFS250216	Reel	Tyvek® and film	VH2O2 (plasma) + EO	30 cm × 100 m	1 reel
3FKFS250218	Reel	Tyvek® and film	VH2O2 (plasma) + EO	38 cm × 100 m	1 reel
3FKFS250222	Reel	Tyvek® and film	VH2O2 (plasma) + EO	50 cm × 100 m	1 reel
3FKFS252204	Reel	Tyvek® 2FS and film	VH2O2 (plasma)	7,5 cm × 100 m	2 reels
3FKFS252206	Reel	Tyvek® 2FS and film	VH2O2 (plasma)	10 cm × 100 m	2 reels
3FKFS252210	Reel	Tyvek® 2FS and film	VH2O2 (plasma)	15 cm × 100 m	1 reel
3FKFS252212	Reel	Tyvek® 2FS and film	VH2O2 (plasma)	20 cm × 100 m	1 reel
3FKFS252214	Reel	Tyvek® 2FS and film	VH2O2 (plasma)	25 cm × 100 m	1 reel
3FKFS252216	Reel	Tyvek® 2FS and film	VH2O2 (plasma)	30 cm × 100 m	1 reel
3FKFS252218	Reel	Tyvek® 2FS and film	VH2O2 (plasma)	38 cm × 100 m	1 reel
3FKFS252222	Reel	Tyvek® 2FS and film	VH2O2 (plasma)	50 cm × 100 m	1 reel



Paper bags with gusset

With printed STEAM indicator - EN ISO 11607

Stericlin® paper bags gusseted correspond to the standard of EN ISO 11607 and are suitable for STEAM, EO, FORM and irradiation sterilisation. They consist of 60 g/m² medical grade paper. A STEAM indicator is additionally printed.

Article No.	Size in cm (width × gusset)	Length in cm	Pack (pcs.)
3FPBT260102	9 × 5	16,8	1000
3FPBT260104	11 × 3	19,6	1000
3FPBT260106	12,5 × 5	25,7	1000
3FPBT260108	14 × 7,5	26	1000
3FPBT260110	14 × 5	33,5	1000
3FPBT260112	16 × 7	38,4	500
3FPBT260114	18 × 9,5	38,4	500
3FPBT260116	20 × 6	33,5	500
3FPBT260118	25 × 10	38,4	500
3FPBT260120	38 × 12,5	54,9	500

WRAPPING METHOD „DIAGONAL“

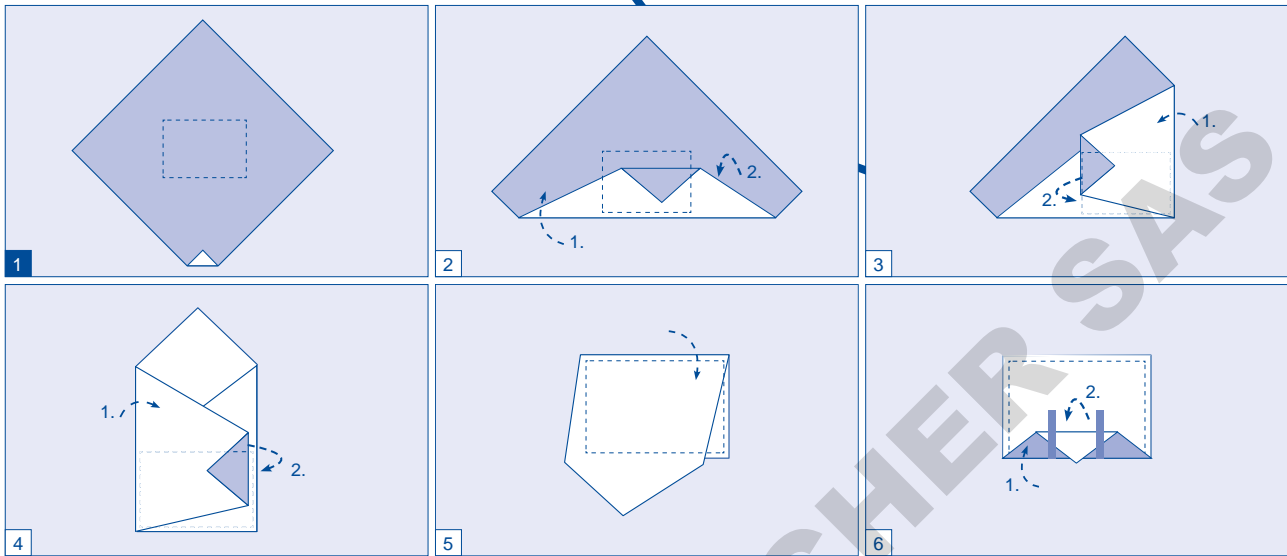

WRAPPING METHOD „PARALLEL“

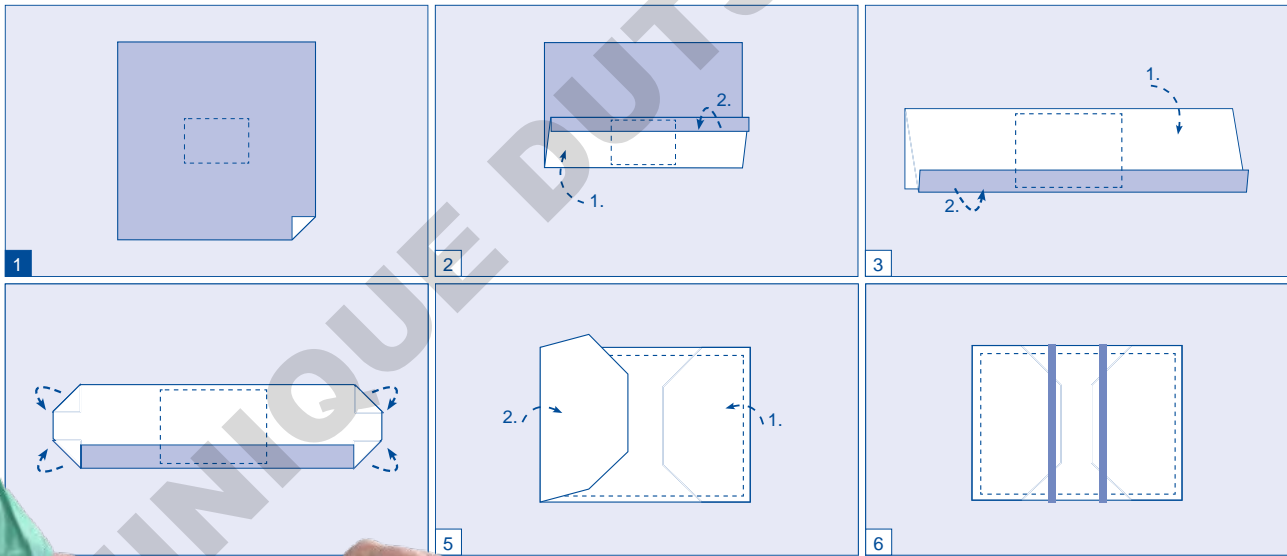

Wrapping material



Even you will be satisfied by the efficiency of flexible packaging

The advantages of stericlin® wrapping material speak for themselves in terms of economy and low storage space requirements. Wrapping material facilitates air extraction, steam penetration and drying after steam sterilisation and also serves as a sterilisation barrier system in other sterilisation processes.

We offer different versions for your flexible packaging, in many sizes, colours and combinations - meeting all your requirements and sterilisation procedures. Stericlin® wrapping material meets the requirements of EN ISO 11607 and EN 868-2.

- Double wrap SMS 6 Plus/SMS 6 Plus
- Double wrap SMS/SMS
- Double wrap SMS/non-woven
- Wrapping material interleaved SMS/SMS
- Wrapping material interleaved SMS/non-woven
- Wrapping material interleaved non-woven/non-woven
- Wrapping material SMS 6 Plus
- Wrapping material polypropylene (SMS)
- Wrapping material non-woven
- Wrapping material crepe



Double wrap SMS 6 PLUS/SMS 6 PLUS

Highest tensile strength and tear resistance of our SMS combined with the absorbency of paper

The innovative SMS 6 PLUS double sheet combines maximum quality with efficiency. It consists of two combined layers: a white, hygroscopic side and a completely hydrophobic, green side. This combination enables particularly reliable dual packaging in just one work step.

The exceptional stability of the 6-layer SMS material ensures maximum protection, while the special material composition supports rapid and complete drying of residual moisture after sterilization. Thanks to the different colors of the sheets, any damage to the packaging is easy to identify. The SMS 6 PLUS double sheet meets all the requirements of modern sterile packaging and offers a cost-effective solution for everyday use.

SMS 6 PLUS can be used for steam and gas sterilization. Validation and manufacturer approval for the respective VH2O2 (plasma) hydrogen plasma sterilizers will take place shortly.

Article No.	Material	Size in cm	Pack (pcs.)
3FDOP391206	SMS 6 PLUS double wrap, SSMMS 55g / SSMMS 55g	60 x 60	200
3FDOP391208	SMS 6 PLUS double wrap, SSMMS 55g / SSMMS 55g	75 x 75	200
3FDOP391212	SMS 6 PLUS double wrap, SSMMS 55g / SSMMS 55g	90 x 90	120
3FDOP391214	SMS 6 PLUS double wrap, SSMMS 55g / SSMMS 55g	100 x 100	100
3FDOP391218	SMS 6 PLUS double wrap, SSMMS 55g / SSMMS 55g	120 x 120	72
3FDOP391226	SMS 6 PLUS double wrap, SSMMS 55g / SSMMS 55g	140 x 140	50



Double wrap SMS/SMS

The innovative wrapping material – EN ISO 11607

The innovative stericlin® double wrap meets the requirements of EN ISO 11607 and EN 868-2 and combines two different wrapping materials made of polypropylene. A blue sheet and a green sheet of non-woven polypropylene, made of synthetic fibres, are firmly welded together at two sides. Damage to the packaging can be identified more easily by the different colours of the inner and outer sheet.

Stericlin® wrapping material made of non-woven polypropylene (SMS) are extremely tear-resistant, robust and drapable non-woven, made of pure synthetic fibres, which are suitable for all types of wrapping material. The sterile barrier system double wrap SMS/SMS from stericlin® is usable for steam and low-temperature sterilisation. According to information from the manufacturers Johnson & Johnson Advanced Sterilization Products ASP (STERRAD® systems), Steelco S.P.A. by Miele Group (PL plasma sterilisers) and GETINGE, this quality is approved and validated for the respective VH2O2 (plasma) hydrogen plasma sterilisers.

Article No.	Material	Size in cm	Pack (pcs.)
3FDOP381206	SMMMS blue 43g / SMMMS green 43g	60 x 60	150
3FDOP381208	SMMMS blue 43g / SMMMS green 43g	75 x 75	96
3FDOP381212	SMMMS blue 43g / SMMMS green 43g	90 x 90	54
3FDOP381214	SMMMS blue 43g / SMMMS green 43g	100 x 100	54
3FDOP381218	SMMMS blue 43g / SMMMS green 43g	120 x 120	54
3FDOP381226	SMMMS blue 43g / SMMMS green 43g	140 x 140	36
3FDOP383208	SMMMS blue 50g / SMMMS green 50g	75 x 75	66
3FDOP383212	SMMMS blue 50g / SMMMS green 50g	90 x 90	54
3FDOP383214	SMMMS blue 50g / SMMMS green 50g	100 x 100	54

Article No.	Material	Size in cm	Pack (pcs.)
3FDOP383218	SMMMS blue 50g / SMMMS green 50g	120 x 120	54
3FDOP383226	SMMMS blue 50g / SMMMS green 50g	140 x 140	36
3FDOP385206	SMMMS blue 60g / SMMMS green 60g	60 x 60	126
3FDOP385208	SMMMS blue 60g / SMMMS green 60g	75 x 75	66
3FDOP385212	SMMMS blue 60g / SMMMS green 60g	90 x 90	54
3FDOP385214	SMMMS blue 60g / SMMMS green 60g	100 x 100	54
3FDOP385218	SMMMS blue 60g / SMMMS green 60g	120 x 120	36
3FDOP385226	SMMMS blue 60g / SMMMS green 60g	140 x 140	36



SSMMS blue 55g /
Non-woven green 67g

SMMS light blue 47g /
Non-woven green 57g

Double wrap SMS/non-woven

The innovative wrapping material – EN ISO 11607

The innovative stericlin® double wrap meets the requirements of EN ISO 11607 and EN 868-2 and combines two different materials together: a blue sheet of non-woven polypropylene (SMS) made of synthetic fibres and a green sheet of non-woven made of cellulose and synthetic fibres, which are firmly welded together at both sides. The respective advantages of the materials are used perfectly.

The extreme stability of the blue SMS material is combined with the properties of the blend fibres of the green non-woven, which supports the complete drying of the residual moisture after sterilisation. Furthermore, damage to the packaging is more easily identifiable by the different colours of the inner (green) and outer (blue) sheet.

Article No.	Material	Size in cm	Pack (pcs.)
3FDOP372208	SMMS light blue 47g / Non-woven green 57g	75 x 75	120
3FDOP372212	SMMS light blue 47g / Non-woven green 57g	90 x 90	100
3FDOP372214	SMMS light blue 47g / Non-woven green 57g	100 x 100	100
3FDOP372218	SMMS light blue 47g / Non-woven green 57g	120 x 120	72
3FDOP372226	SMMS light blue 47g / Non-woven green 57g	140 x 140	52
3FDOP373208	SSMMS blue 55g / Non-woven green 67g	75 x 75	100
3FDOP373212	SSMMS blue 55g / Non-woven green 67g	90 x 90	100
3FDOP373214	SSMMS blue 55g / Non-woven green 67g	100 x 100	80
3FDOP373218	SSMMS blue 55g / Non-woven green 67g	120 x 120	60
3FDOP373226	SSMMS blue 55g / Non-woven green 67g	140 x 140	40

DUTSCHER SAS

Wrapping material interleaved SMS/SMS

Non-woven polypropylene (SMS) in two colours - EN ISO 11607

Stericlin® wrapping material made of non-woven polypropylene (SMS) are extremely tear-resistant, robust and drapable non-woven, made of pure synthetic fibres, which are suitable for all types of wrapping material.

They are usable for steam and low-temperature sterilisation. According to STERRAD®-Info of the manufacturer Johnson & Johnson from August 2018 the quality stericlin® wrapping material interleaved SMS/SMS is also validated for the STERRAD®-systems Advanced Sterilisation Products (ASP).

Our stericlin® wrapping material interleaved comes factory-made with blue and green sheets of non-woven polypropylene alternately stacked. Thereby assembling the sheets from two different boxes is not necessary. The preparation of the packing procedure for the double-packaging is significantly simplified. Damage to the packaging can be identified more easily through the different colours of the inner and outer packaging.

We recommend that you create a double-packaging by two successive packaging operations. Only that way you will get efficient double packaging, which enables a bacterial count reduction during unpacking, ensuring an aseptic presentation.

Article No.	Material	Size in cm	Pack (pcs.)
3FITL381106	SMMMS blue 43g / SMMMS green 43g	60 × 60	360
3FITL381108	SMMMS blue 43g / SMMMS green 43g	75 × 75	180
3FITL381114	SMMMS blue 43g / SMMMS green 43g	100 × 100	150
3FITL381118	SMMMS blue 43g / SMMMS green 43g	120 × 120	102
3FITL381126	SMMMS blue 43g / SMMMS green 43g	140 × 140	102



SMMS blue 60g /
Non-woven green 67g

SSMMS light blue 43g /
Non-woven green 57g

Wrapping material interleaved SMS/non-woven

Two types of non-woven and a lot of advantages – EN ISO 11607

Stericlin® wrapping material interleaved meets the requirements of EN ISO 11607 and EN 868-2 and combines two different materials together: a blue non-woven polypropylene (SMS) sheet made of synthetic fibres and a green non-woven sheet made of cellulose and synthetic fibres which are alternately placed in a stack. The respective advantages of the materials are used perfectly.

The extreme stability of the blue SMS material is combined with the properties of the blend fibres of the green non-woven, which supports the complete drying of the residual moisture after sterilisation. Furthermore, damage to the packaging is more easily identifiable by the different colours of the inner (green) and outer (blue) sheet.

We recommend that you create a double-packaging by two successive packaging operations. Only that way you will get efficient double packaging, which enables a bacterial count reduction during unpacking, ensuring an aseptic presentation.

Article No.	Material	Size in cm	Pack (pcs.)
3FITL370108	SSMMS light blue 43g / Non-woven green 57g	75 × 75	200
3FITL370114	SSMMS light blue 43g / Non-woven green 57g	100 × 100	200
3FITL370118	SSMMS light blue 43g / Non-woven green 57g	120 × 120	120
3FITL370126	SSMMS light blue 43g / Non-woven green 57g	140 × 140	120
3FITL375108	SMMS blue 60g / Non-woven green 67g	75 × 75	200
3FITL375114	SMMS blue 60g / Non-woven green 67g	100 × 100	160
3FITL375118	SMMS blue 60g / Non-woven green 67g	120 × 120	120
3FITL375126	SMMS blue 60g / Non-woven green 67g	140 × 140	80

Wrapping material interleaved non-woven/non-woven

Non-woven in two colours – EN ISO 11607

The stericlin® non-woven 52g is a material which is characterised by a very good drapability and high mechanical stability. It meets the requirements of EN ISO 11607 and EN 868-2 and is suitable for packaging of medical supplies, such as instrument trays and textiles. The mixed fibres (cellulose and synthetic fibres) of the non-woven fabric support the complete drying of the residual moisture after sterilisation.

Packing with stericlin® interleaved wrapping material offers many advantages. Damage to the packaging is more easily distinguishable through the different colours of the inner and outer packaging. Because blue and green sheets are alternately stacked, the sheet assembly of two different boxes is omitted.

We recommend that you create a double-packaging by two successive packaging operations. Only that way you will get efficient double packaging, which enables a bacterial count reduction during unpacking, ensuring an aseptic presentation.

Article No.	Material	Size in cm	Pack (pcs.)
3FITL340108	Non-woven blue 52g / Non-woven green 52g	75 x 75	204
3FITL340112	Non-woven blue 52g / Non-woven green 52g	90 x 90	204
3FITL340114	Non-woven blue 52g / Non-woven green 52g	100 x 100	204
3FITL340118	Non-woven blue 52g / Non-woven green 52g	120 x 120	126
3FITL340120	Non-woven blue 52g / Non-woven green 52g	120 x 140	102



Wrapping material SMS 6 PLUS

Highest tensile strength and tear resistance of our SMS combined with the absorbency of paper

The SMS 6 PLUS single sheet made of polypropylene (SMS) is an extremely tear-resistant and durable sheet packaging that is ideal for all types of packaging. Made from several layers of high-quality spunbond and meltblown fibers, it offers an excellent combination of flexibility, drapability and an effective germ barrier.

Depending on requirements, the SMS 6 PLUS single sheet can be used as a cost-effective solution for inner container wrapping or for double packaging of sterile goods. The material is particularly absorbent, effectively absorbing and draining moisture, which helps the residual moisture to dry completely after sterilization.

The SMS 6 PLUS single sheet complies with the requirements of EN ISO 11607 and EN 868-2, making it a reliable choice for everyday use.

SMS 6 PLUS can be used for steam and gas sterilization. Validation and manufacturer approval for the respective VH2O2 (plasma) hydrogen plasma sterilizers will take place shortly.

Article No.	Material	Size in cm	Pack (pcs.)
3FSMS390106	SMS 6 PLUS, SSMMMS 55g	60 x 60	400
3FSMS390108	SMS 6 PLUS, SSMMMS 55g	75 x 75	400
3FSMS390112	SMS 6 PLUS, SSMMMS 55g	90 x 90	250
3FSMS390114	SMS 6 PLUS, SSMMMS 55g	100 x 100	200
3FSMS390116	SMS 6 PLUS, SSMMMS 55g	100 x 140	150
3FSMS390118	SMS 6 PLUS, SSMMMS 55g	120 x 120	150
3FSMS390120	SMS 6 PLUS, SSMMMS 55g	120 x 140	100
3FSMS390126	SMS 6 PLUS, SSMMMS 55g	140 x 140	100
3FSMS390124	SMS 6 PLUS, SSMMMS 55g	130 x 150	120

SMMS blue 60g

SSMMS blue / violet 43g

SMMS blue 37g

Wrapping material polypropylene (SMS)

The suitable grammage for each application – EN ISO 11607

Stericlin® wrapping material made of non-woven polypropylene (SMS) are extremely tear-resistant, robust and drapable non-woven, made of pure synthetic fibres, which are suitable for all types of wrapping material. The higher the grammage of the non-woven, the more resistant the flexible packaging produced from it. All stericlin® wrapping material made of non-woven polypropylene (SMS) meet the requirements of EN ISO 11607 and EN 868-2.

Our non-woven polypropylene consisting of several layers of spunbond fibres (S) and meltblown fibres (M). Spunbond layers provide exceptional flexibility and drapability, whereas meltblown layers provide excellent defence against bacteria.

For double packaging, you can combine SMS, non-woven and crepe packaging – regardless of colour and format. Please refer to the packing methods described in the DIN 58953, part 7.

We recommend that you create a double-packaging by two successive packaging operations. Only that way you will get efficient double packaging, which enables a bacterial count reduction during unpacking, ensuring an aseptic presentation.

Article No.	Material	Size in cm	Pack (pcs.)
3FSMS355106	SMMS blue 37g	60 × 60	480
3FSMS355108	SMMS blue 37g	75 × 75	200
3FSMS355112	SMMS blue 37g	90 × 90	200
3FSMS355114	SMMS blue 37g	100 × 100	200
3FSMS355118	SMMS blue 37g	120 × 120	120
3FSMS355120	SMMS blue 37g	120 × 140	120
3FSMS355126	SMMS blue 37g	140 × 140	120
3FSMS355127	SMMS blue 37g	140 × 190	80
3FSMS365114	SMMS blue 60g	100 × 100	104
3FSMS365118	SMMS blue 60g	120 × 120	96
3FSMS365126	SMMS blue 60g	140 × 140	80

Article No.	Material	Size in cm	Pack (pcs.)
3FSMS360104	SSMMS blue / violet 43g	50 × 50	500
3FSMS360108	SSMMS blue / violet 43g	75 × 75	200
3FSMS360112	SSMMS blue / violet 43g	90 × 90	200
3FSMS360114	SSMMS blue / violet 43g	100 × 100	200
3FSMS360118	SSMMS blue / violet 43g	120 × 120	120
3FSMS360120	SSMMS blue / violet 43g	120 × 140	120
3FSMS360126	SSMMS blue / violet 43g	140 × 140	120
3FSMS360128	SSMMS blue / violet 43g	150 × 190	48



Non-woven blue 52g

Non-woven green 52g

Non-woven blue 59g

Wrapping material non-woven

The combination of cellulose and synthetic fibres – EN ISO 11607

Stericlin® wrapping material made of non-woven distinguish by excellent drapability in conjunction with high mechanical strength. It meets the requirements of EN ISO 11607 and EN 868-2 and is suitable for the packaging of medical devices such as instrument trays and textiles. The higher the grammage of the non-woven, the more resistant the flexible packaging produced from it.

The mixed fibres (cellulose and synthetic fibres) of the non-woven material support the complete drying of the residual moisture after sterilisation.

For double packaging, you can combine SMS, non-woven and crepe packaging – regardless of colour and format. Please refer to the packing methods described in the DIN 58953, part 7.

We recommend that you create a double-packaging by two successive packaging operations. Only that way you will get efficient double packaging, which enables a bacterial count reduction during unpacking, ensuring an aseptic presentation.

Article No.	Material	Size in cm	Pack (pcs.)
3FVLI330104	Non-woven blue 52g	50 × 50	504
3FVLI330106	Non-woven blue 52g	60 × 60	504
3FVLI330108	Non-woven blue 52g	75 × 75	204
3FVLI330112	Non-woven blue 52g	90 × 90	204
3FVLI330114	Non-woven blue 52g	100 × 100	204
3FVLI330116	Non-woven blue 52g	100 × 140	102
3FVLI330118	Non-woven blue 52g	120 × 120	126
3FVLI330120	Non-woven blue 52g	120 × 140	126
3FVLI330124	Non-woven blue 52g	130 × 150	102
3FVLI330126	Non-woven blue 52g	140 × 140	102
3FVLI330128	Non-woven blue 52g	150 × 190	108

Article No.	Material	Size in cm	Pack (pcs.)
3FVLI330206	Non-woven green 52g	60 × 60	504
3FVLI330208	Non-woven green 52g	75 × 75	204
3FVLI330212	Non-woven green 52g	90 × 90	204
3FVLI330214	Non-woven green 52g	100 × 100	204
3FVLI330218	Non-woven green 52g	120 × 120	126
3FVLI350106	Non-woven blue 59g	60 × 60	504
3FVLI350108	Non-woven blue 59g	75 × 75	204
3FVLI350112	Non-woven blue 59g	90 × 90	204
3FVLI350114	Non-woven blue 59g	100 × 100	204
3FVLI350118	Non-woven blue 59g	120 × 120	126
3FVLI350126	Non-woven blue 59g	140 × 140	102

Wrapping material crepe

Made of 100% cellulose-based medical paper – EN ISO 11607

Stericlin® crepe is the most economical wrapping material and is made of 100% cellulose-based medical paper. This wrapping material is particularly suitable for the packaging of lighter instruments and kits. The material meets the requirements of EN ISO 11607 and EN 868-2.

For double packaging, you can combine SMS, non-woven and crepe packaging – regardless of colour and format. Please refer to the packing methods described in the DIN 58953, part 7.

We recommend that you create a double-packaging by two successive packaging operations. Only that way you will get efficient double packaging, which enables a bacterial count reduction during unpacking, ensuring an aseptic presentation.

Article No.	Material	Size in cm	Pack (pcs.)
3FPAP310102	Crepe white	40 × 40	1440
3FPAP310106	Crepe white	60 × 60	702
3FPAP310108	Crepe white	75 × 75	348
3FPAP310112	Crepe white	90 × 90	252
3FPAP310114	Crepe white	100 × 100	252
3FPAP310118	Crepe white	120 × 120	126

Article No.	Material	Size in cm	Pack (pcs.)
3FPAP310202	Crepe green	40 × 40	1440
3FPAP310204	Crepe green	50 × 50	702
3FPAP310206	Crepe green	60 × 60	702
3FPAP310208	Crepe green	75 × 75	348
3FPAP310212	Crepe green	90 × 90	252
3FPAP310214	Crepe green	100 × 100	252
3FPAP310218	Crepe green	120 × 120	126



CSSD accessories



For maximum safety during the sterilisation process

It is of critical importance to ensure a correct, safe and complete reprocessing process for medical devices, and to validate and document the process sequence. Possible errors or failure could lead to serious consequences.

CSSD accessories from stericlin® enable unparalleled quality assurance: first-class products from a single supplier, excellent service included.

- Adhesive tapes
- Tray accessories
- Container accessories
- Cable ties
- Instrument protection
- Seal seam tests
- Protective packaging
- Hygiene wipes
- Waste bags with adhesive strip
- Disposable carton

Indicator change after sterilization (colours not binding, may differ in reality). Images of the strips show original size.

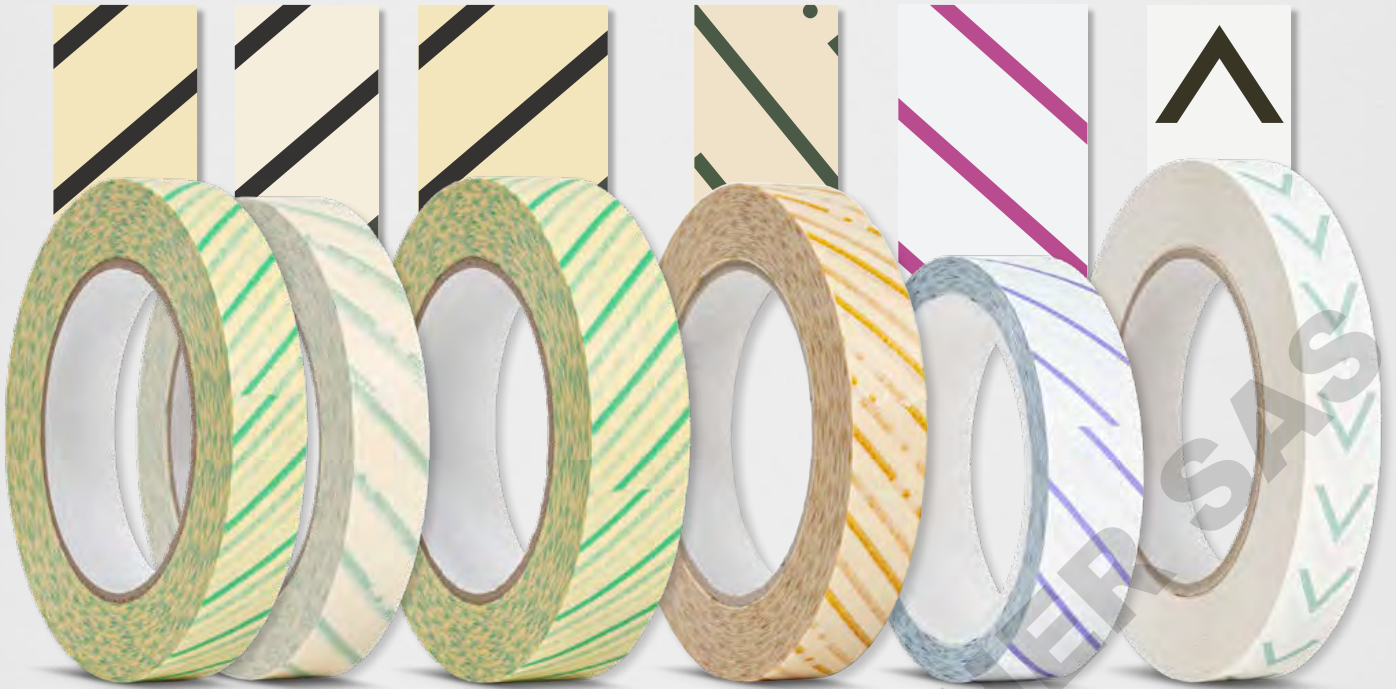

3FKLB410710

3FKLB410302

3FKLB410712

3FKLB410308

3FKLB410410

3FKLB410112 /
3FKLB410412



3FKLB410702

3FKLB410402

3FKLB410704

3FKLB410706

Stericlin® adhesive tapes

With or without indicator imprint

Stericlin® adhesive tapes are used for safe and sterilisation-resistant sealing of crepe, non-woven and SMS wrapping materials. They are available with or without indicator print.

Article No.	Description	Width, length	Pack
3FKLB410710 / 3FKLB410302 *	Crepe, beige, with STEAM indicator	19 mm, 50 m	48 reels
3FKLB410712	Crepe, beige, with STEAM indicator	25 mm, 50 m	36 reels
3FKLB410308	Crepe, beige, with EO indicator	19 mm, 50 m	48 reels
3FKLB410410	Film, white, with VH2O2 (plasma) indicator	25 mm, 25 m	12 reels

Article No.	Description	Width, length	Pack
3FKLB410112 / 3FKLB410412	Crepe, white, with DRY-HEAT indicator	19 mm, 50 m	48 reels
3FKLB410702 / 3FKLB410402 *	Crepe, beige, without indicator	19 mm, 50 m	48 reels
3FKLB410704	Crepe, beige, without indicator	25 mm, 50 m	36 reels
3FKLB410706	Crepe, beige, without indicator	50 mm, 50 m	24 reels

* Not stocked - minimum order quantity: 2304 rolls; lower adhesive strength



3FSZB410304

3FSZB410303
3FSZB410305

3FSZB410302

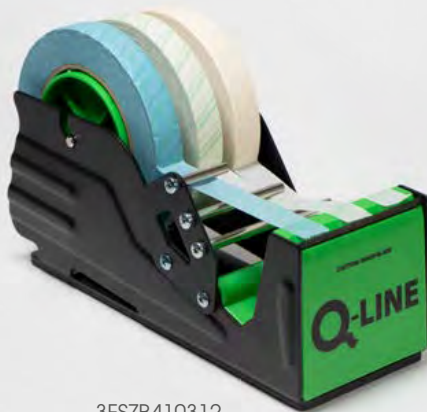

3FSZB410312



3FSZB670220

Tape dispenser

Accessories for stericlin® adhesive tapes

Our tape dispensers can be used for all stericlin® adhesive tapes. They stand for an efficient, quick and easy work process.

Article No.	Description	Pack (pcs.)
3FSZB410302	Tape dispenser, colour: blue (made of metal)	1
3FSZB410303	Spare blades for 3FSZB410302	10
3FSZB410304	Dual tape dispenser, colour: blue (made of metal)	1
3FSZB410305	Spare blades for 3FSZB410304	10
3FSZB410312	Triple tape dispenser, colour: blue/green (made of metal)	1
3FSZB670220	Label dispenser, made of metal, heavy duty, multiple dispenser (maximum 216 mm total width), for labels up to 77mm core diameter, dimensions: 230 x 220 x 130 mm (L x W x H), base: metal with suction cup and height adjustable feet	1

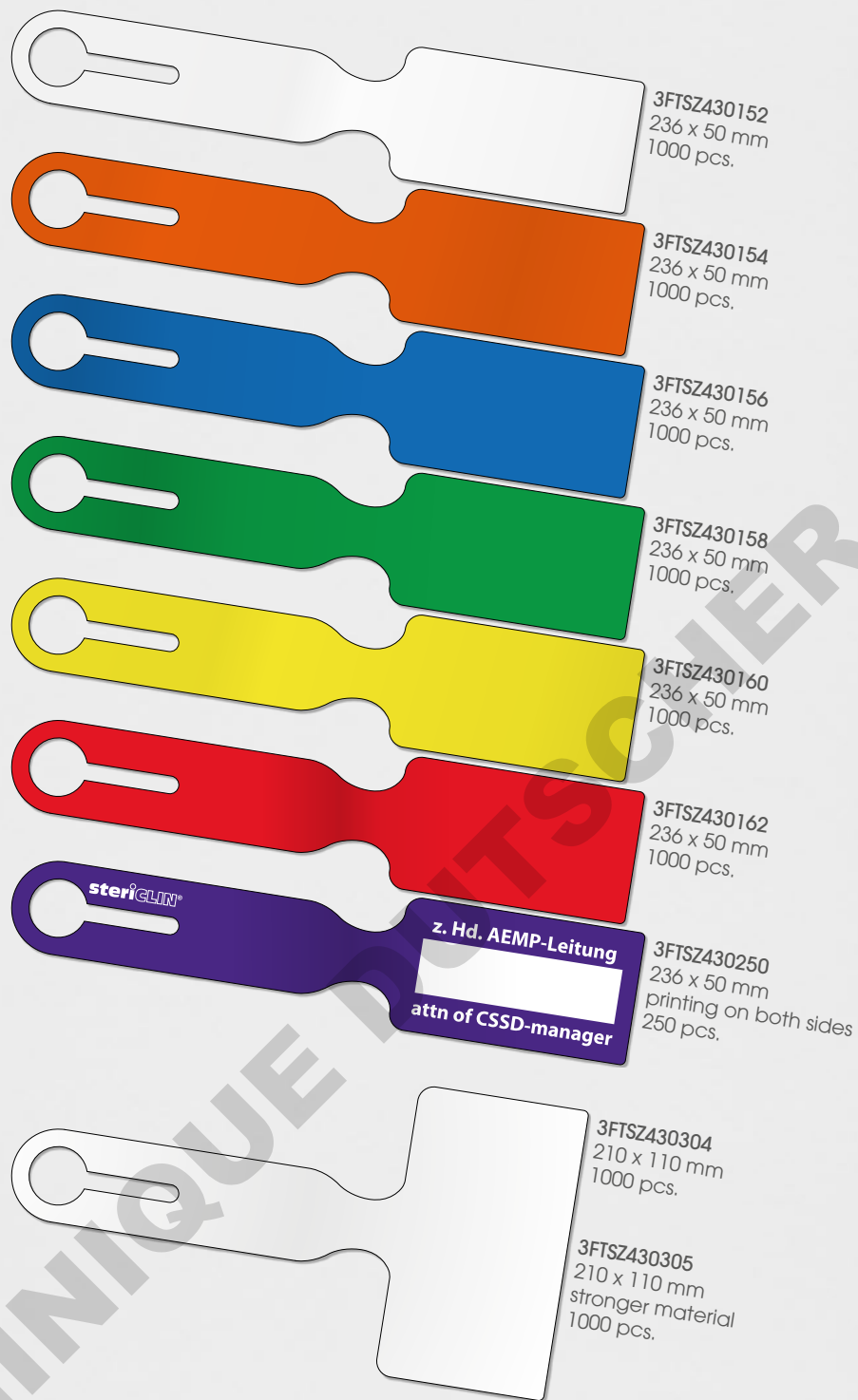

Stericlin® tray labels

The simple marking of instrument trays

For quick identification, sorting and coding of instrument trays. Due to their material properties, stericlin® tray labels are suitable for the entire reprocessing cycle and can be written on with fiber pens or glued on with labels. Various colours and labels provide the necessary flexibility to communicate information between departments. Customized combinations can also be manufactured upon customer request.

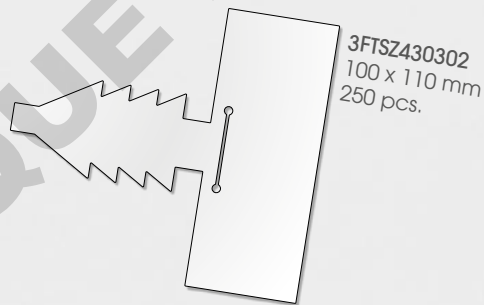

Article No.	Size (mm)	Colour	Printing	Pack (pcs.)
3FTSZ430152	236 x 50	white	blank	1000
3FTSZ430154	236 x 50	orange	blank	1000
3FTSZ430156	236 x 50	blue	blank	1000
3FTSZ430158	236 x 50	green	blank	1000
3FTSZ430160	236 x 50	yellow	blank	1000
3FTSZ430162	236 x 50	red	blank	1000
3FTSZ430250	236 x 50	violet	both sides	250
3FTSZ430304	210 x 110	white	blank	1000
3FTSZ430305	210 x 110	white	blank	1000
		stronger material		

Article No.	Size (mm)	Colour	Printing	Pack (pcs.)
3FTSZ430172	160 x 35	white	blank	1000
3FTSZ430174	160 x 35	orange	blank	1000
3FTSZ430176	160 x 35	blue	blank	1000
3FTSZ430178	160 x 35	green	blank	1000
3FTSZ430180	160 x 35	yellow	blank	1000
3FTSZ430182	160 x 35	red	blank	1000
3FTSZ430302	100 x 110	white	blank	250



Stericlin® silicone plugs

For fixation of basket labels and corner protectors

Our Stericlin® silicone plugs offer flexibility in fixation. The plugs are easy to attach as well as to remove and provide a good flow of cleaning media.

We offer different colours for the differentiation of e.g. departments or purposes.

Article No.	Description	Pack (pcs.)
3FEDS843302	For wire mesh baskets, colour: blue, length: 22 mm, diameter: 3 mm (pen) / 16 mm (plate)	100
3FEDS843304	For wire mesh baskets, colour: yellow, length: 22 mm, diameter: 3 mm (pen) / 16 mm (plate)	100
3FEDS843308	For wire mesh baskets, colour: transparent, length: 22 mm, diameter: 3 mm (pen) / 16 mm (plate)	100
3FEDS843320	For perforated plate baskets, colour: light blue, length: 13 mm, diameter: 2 mm (pen) / 12 mm (plate)	100



3FTSZ422202



3FTSZ422105

Stericlin® corner reinforcement for sterilisation trays

Reliable protection for your flexible packaging

Robust and reliable: stericlin® corner reinforcement prevents damage to the sterile barrier system, which can be caused by sharp edges or feet of heavy trays respectively rental trays. The corner reinforcement optimally protects the wrapping material during sterilisation, transport and storage.

The silicone corner protectors can be fixed with our silicone plugs (page 74) or silicone cable ties (page 92).

Article No.	Description	Size in cm	Pack (pcs.)
3FTSZ422105	Corner protectors made of paper	10 × 10 × 5	1200
3FTSZ422202	Stericlin® corner protectors made of silicone, heat resistant up to 200°C, colour: green, suitable for permanent attachment to perforated plate or wire mesh baskets by using our silicone plugs or cable ties	7,5 × 7,5 × 3	4

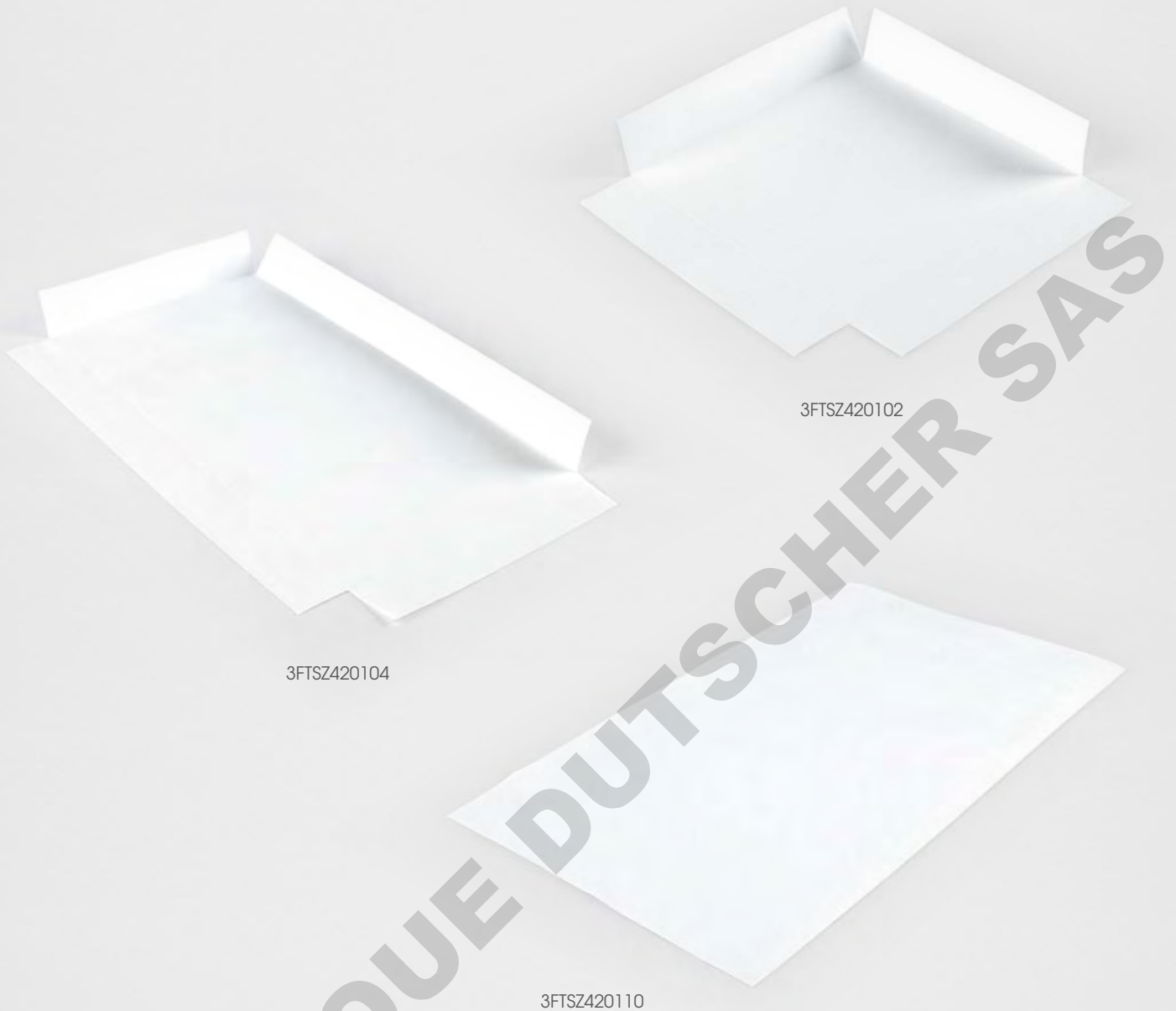

3FTSZ420104

3FTSZ420102

3FTSZ420110

Stericlin® tray liners

Reliable protection for your flexible packaging

Robust and reliable: stericlein® tray liners for mesh trays are made of heavy-duty, moisture-absorbent crepe to avoid damage of the sterile barrier wrapping material during sterilisation, transport and storage. They also support the drying process.

Article No.	Size in cm	Pack (pcs.)
3FTSZ420102	25 × 25 *; outer dimensions 35 × 35	500
3FTSZ420104	48 × 25 *; outer dimensions 58 × 35	500
3FTSZ420110	58 × 35	708

* The versions 25 × 25 cm and 48 × 25 cm are delivered „pre-formed“ – with cutted edges and in front folded protrusion (5 cm per side).

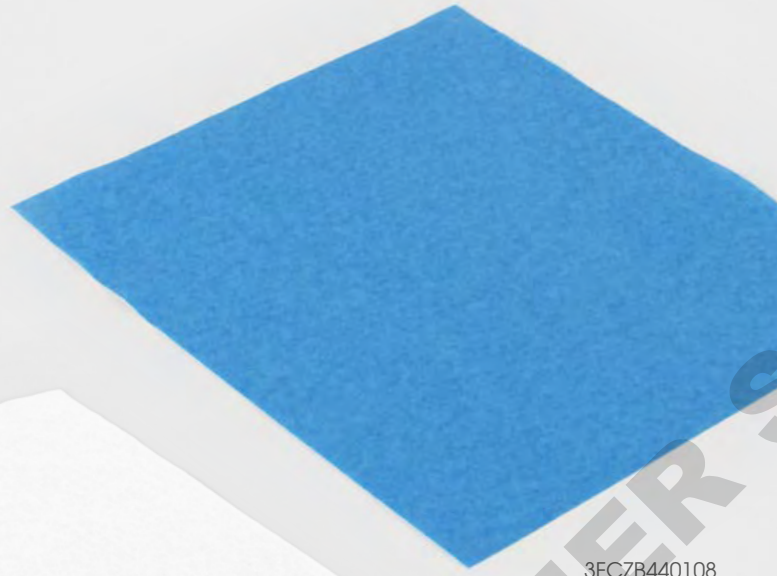

3FCZB440108



3FCZB440114



Stericlin® absorbent inner layers

To avoid wet instrument trays

Stericlin® absorbent pads made of non-woven fabric (3FCZB440108-110) and pure polypropylene (3FCZB440112-114) with a special coating absorb the condensation that forms in the container or instrument tray during the sterilization process and distribute it evenly so that it evaporates more easily during the drying process.

Please note: Absorbent inner layers have no barrier function, therefore they do not replace a sterile barrier system at all.

3FCZB440112-114 can also be recycled as a plastic monomaterial with other PP nonwovens on the market.

Article No.	Size in cm	Description	Pack (pcs.)
3FCZB440108	25 x 30	blue	1000
3FCZB440110	30 x 50	blue	1000
3FCZB440112	25 x 30	strong, white	1000
3FCZB440114	30 x 50	strong, white	1000



MultiSeal

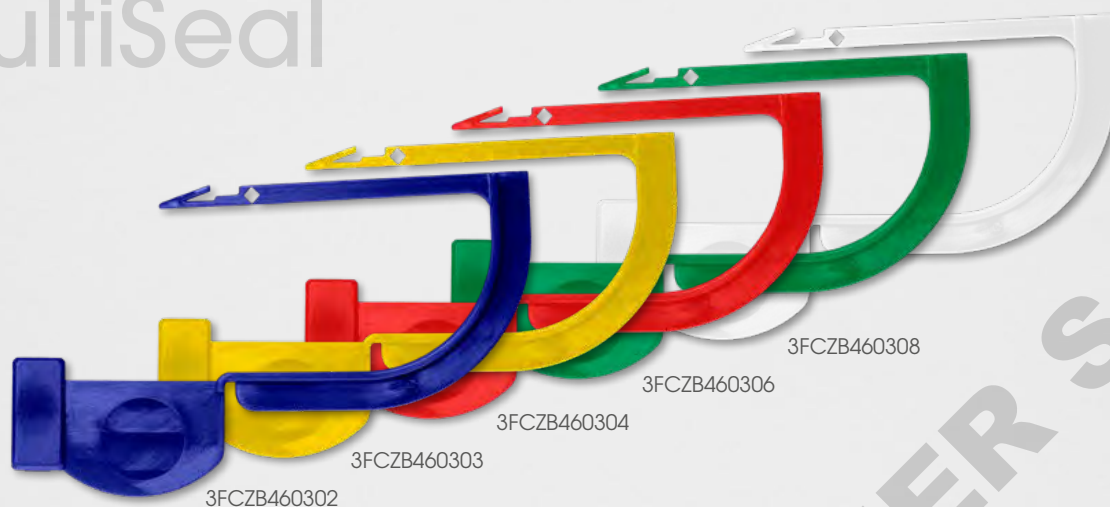

DuoSeal



Stericlin® plastic seals Solo / Duo and Multi

Secure sealing for protection against manipulation

Stericlin® plastic seals consist of sterilisation-resistant polypropylene and are available in different colours. All common container systems with locking eyelets can be securely sealed in simple steps.

Stericlin® SoloSeals are ideally suited for Aesculap containers - Stericlin® DuoSeals are recommended for Wagner containers and Stericlin® MultiSeals for various other containers. The special construction of all versions of the Stericlin® plastic seal with a large opening angle facilitates simple fitting to the container and locking by hooking on.

The container can only be opened by breaking the seal. This ensures that the sterile goods container has not been manipulated on its arrival at the place of use. Stericlin® plastic seals are opened by bending at the defined breaking point and turning the handle plate gently. The Stericlin® plastic seal can then be broken without any effort.

SoloSeal

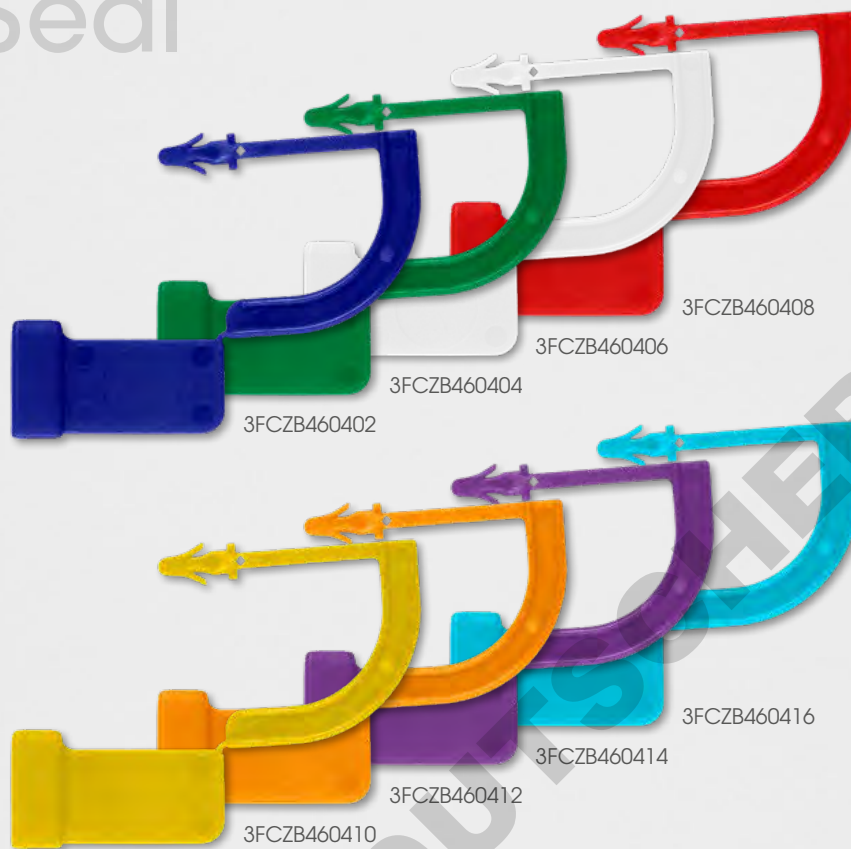

Without indicator				
Article No.	Description	Container compatibility	Colour	Pack (pcs.)
3FCZB460302	MultiSeal	Diverse	dark blue	1000
3FCZB460303	MultiSeal	Diverse	yellow	1000
3FCZB460304	MultiSeal	Diverse	red	1000
3FCZB460306	MultiSeal	Diverse	green	1000
3FCZB460308	MultiSeal	Diverse	white	1000
3FCZB460452	DuoSeal	Aesculap / Wagner	red	1000
3FCZB460454	DuoSeal	Aesculap / Wagner	dark blue	1000
3FCZB460456	DuoSeal	Aesculap / Wagner	green	1000
3FCZB460458	DuoSeal	Aesculap / Wagner	yellow	1000
3FCZB460402	SoloSeal	Aesculap	dark blue	1000
3FCZB460404	SoloSeal	Aesculap	green	1000
3FCZB460406	SoloSeal	Aesculap	white	1000
3FCZB460408	SoloSeal	Aesculap	red	1000
3FCZB460410	SoloSeal	Aesculap	yellow	1000
3FCZB460412	SoloSeal	Aesculap	orange	1000
3FCZB460414	SoloSeal	Aesculap	violet	1000
3FCZB460416	SoloSeal	Aesculap	light blue	1000

With indicator				
Article No.	Description	Container compatibility	Colour	Pack (pcs.)
3FCZB460310	MultiSeal	Diverse	dark blue	1000
3FCZB460313	MultiSeal	Diverse	yellow	1000
3FCZB460312	MultiSeal	Diverse	red	1000
3FCZB460314	MultiSeal	Diverse	green	1000
3FCZB460316	MultiSeal	Diverse	white	1000
3FCZB460460	DuoSeal	Aesculap / Wagner	red	1000
3FCZB460462	DuoSeal	Aesculap / Wagner	dark blue	1000
3FCZB460464	DuoSeal	Aesculap / Wagner	green	1000
3FCZB460466	DuoSeal	Aesculap / Wagner	yellow	1000
3FCZB460418	SoloSeal	Aesculap	dark blue	1000
3FCZB460420	SoloSeal	Aesculap	green	1000
3FCZB460422	SoloSeal	Aesculap	white	1000
3FCZB460424	SoloSeal	Aesculap	red	1000
3FCZB460426	SoloSeal	Aesculap	yellow	1000
3FCZB460428	SoloSeal	Aesculap	orange	1000
3FCZB460430	SoloSeal	Aesculap	violet	1000
3FCZB460432	SoloSeal	Aesculap	light blue	1000

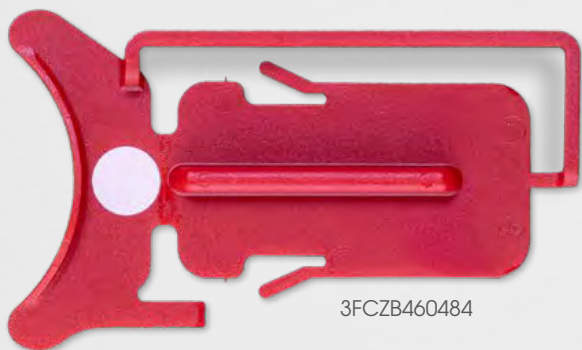

3FCZB460484



3FCZB460482



3FSZB861302



3FSZB861304

Special seals and security seals for various applications

For identification, assignment and transmission of information

The original KLS Martin microStop® and MiniSet single-use plastic seals are simply clicked into the corresponding containers from above and lock themselves in place.

Security seals are used to mark and secure a wide variety of transport goods. Containers, trolleys, boxes, transport carts and other items are protected against tampering. The consecutive numbering ensures traceability and provides complete documentation. Thanks to the practical removal aid, the seal can be opened without tools.

Article No.	Description	Container compatibility	Colour	Indicator	Pack (pcs.)
3FCZB460482	KLS Martin miniset seal	MiniSet containers	red	STEAM	1000
3FCZB460484	KLS Martin multi seal	microStop® containers	red	STEAM	500
3FCZB460486	KLS Martin multi seal	microStop® containers	red	no	500
3FSZB861302	steriCLIN® safety seal made of polypropylene, length: 230 mm, with removal aid, consecutively numbered	Various	red	no	100
3FSZB861304	steriCLIN® safety seal made of polypropylene, length: 230 mm, with removal aid, consecutively numbered	Various	green	no	100

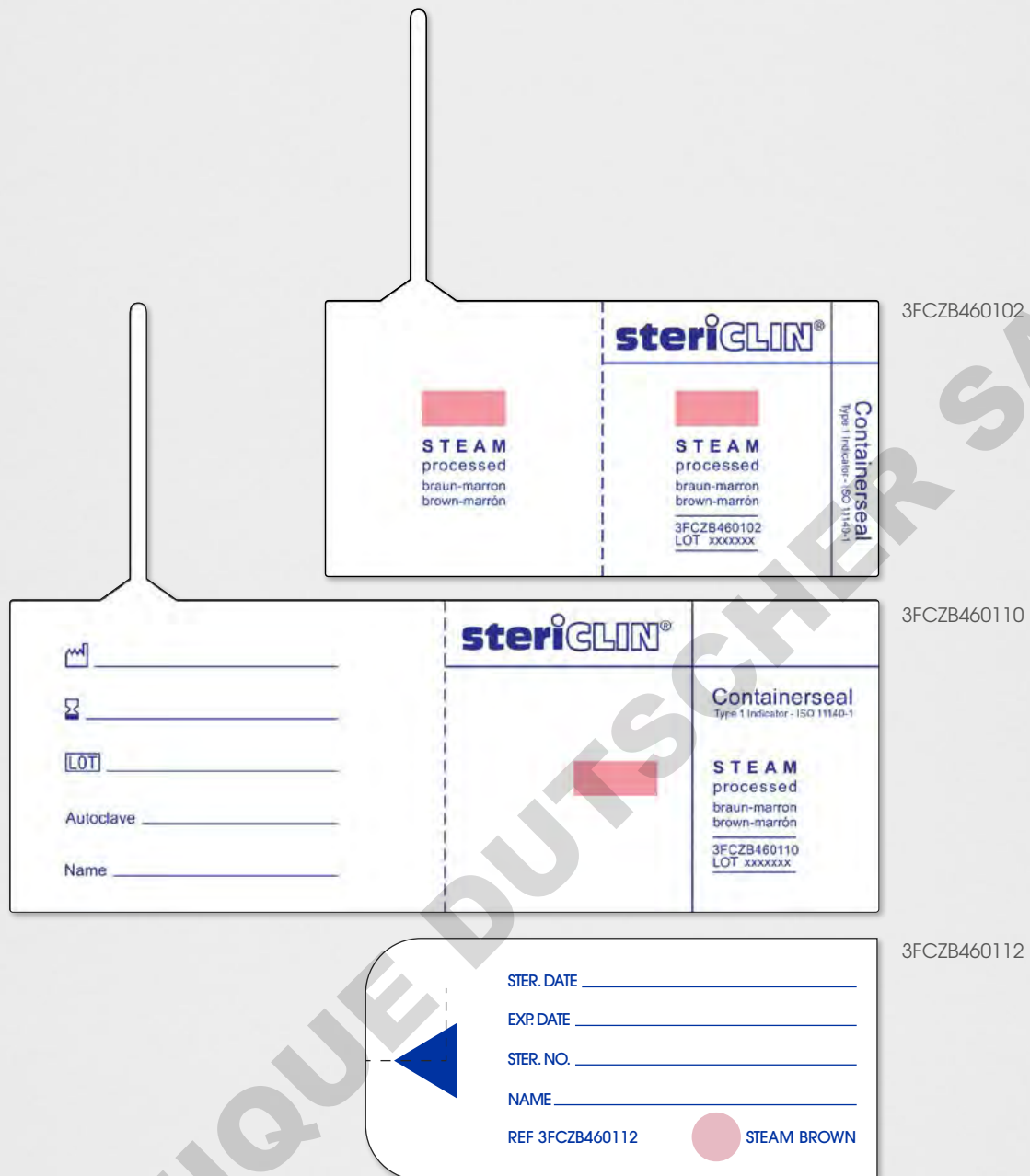

3FCZB460102

3FCZB460110

3FCZB460112

Container seals made of sterilisation-proof special cardboard

Safe protection against manipulation

All common container systems with locking loop can be easily and securely sealed with the steriGLIN® container seal. The container can only be opened by destroying the seal.

Article No.	Description	Size (width × height)	Pack (pcs.)
3FCZB460102	with STEAM indicator, without documentation field	80 × 40 mm (folded: 40 × 40 mm), strip: 2,5 × 70 mm	500
3FCZB460110	with STEAM indicator, with documentation field	125 × 45 mm (folded: 62,5 × 45 mm), strip: 2,5 × 70 mm	500
3FCZB460112	with STEAM indicator, self-adhesive, insert from right	74 × 35 mm	1000



3FEDS843202



3FEDS843204



3FEDS843206



3FEDS843208



3FEDS843210

Identification plates

For labelling, allocation and transmission of information

Identification plates made of aluminium can be used, among other things, in the drawers of various container types and also communicate information by means of a colour assignment.

Article No.	Description	Size in mm	Colour	Pack (pcs.)
3FEDS843202	Aluminium	50 × 18	blue	25
3FEDS843204	Aluminium	50 × 18	green	25
3FEDS843206	Aluminium	50 × 18	red	25
3FEDS843208	Aluminium	50 × 18	yellow	25
3FEDS843210	Aluminium	50 × 18	natural	25

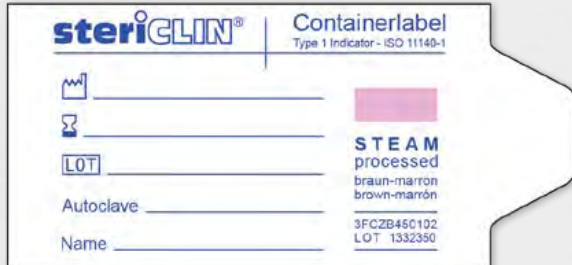

3FCZB450102

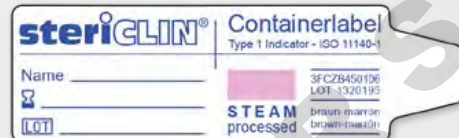

3FCZB450106



3FCZB450104



3FCZB450108

Stericlin® container labels

Many versions – for all common container systems

Labelling and identification made easy! Stericlin® container labels are self-adhesive and contain all the fields relevant for recording information. In this way, reliable tracking of every container is guaranteed.

We can implement other dimensions or special requirements for you individually. Please contact us, we will advise you.

Article No.	Container type	Size (width × height)	Pack (pcs.)
3FCZB450102	Aesculap	75 × 35 mm (incl. flap)	1000
3FCZB450104	Aesculap	67 × 39 mm (incl. flap)	1000
3FCZB450106	Aesculap	60 × 18 mm (incl. flap)	1000
3FCZB450108	Wagner	59 × 40 mm	1000



3FSKS675222

Accessories for small set mini & dental containers

For convenient and residue-free labeling

With our accessories, your small set mini & dental containers can be labeled without leaving any residue very easily. As the insert label does not require any adhesive, the foil label is particularly easy to remove without leaving any residue even after sterilization thanks to the peel-off area marked in blue. This way, you can attach your existing adhesive labels and the CSSD has no problems with adhesive residue.

The slide-in label made of high-quality stainless steel is the reusable solution for securely attaching your production labels to existing container inserts, even during STEAM sterilization.



3FEDS843105
Slide-in Label „Bamberg“

Article No.	Size in mm	Description	Pack (pcs.)
3FSKS675222	80 × 40	Film label on roll, extra easy to remove with peel-off area marked in blue, ideal for use as a residue-free backing material for other labeling materials, core: 76 mm, roll width: 83 mm	500
3FEDS843105	50 × 18	„Bamberg“ slide-in label, for simple clamp fastening of labeling material on small set and dental containers	500

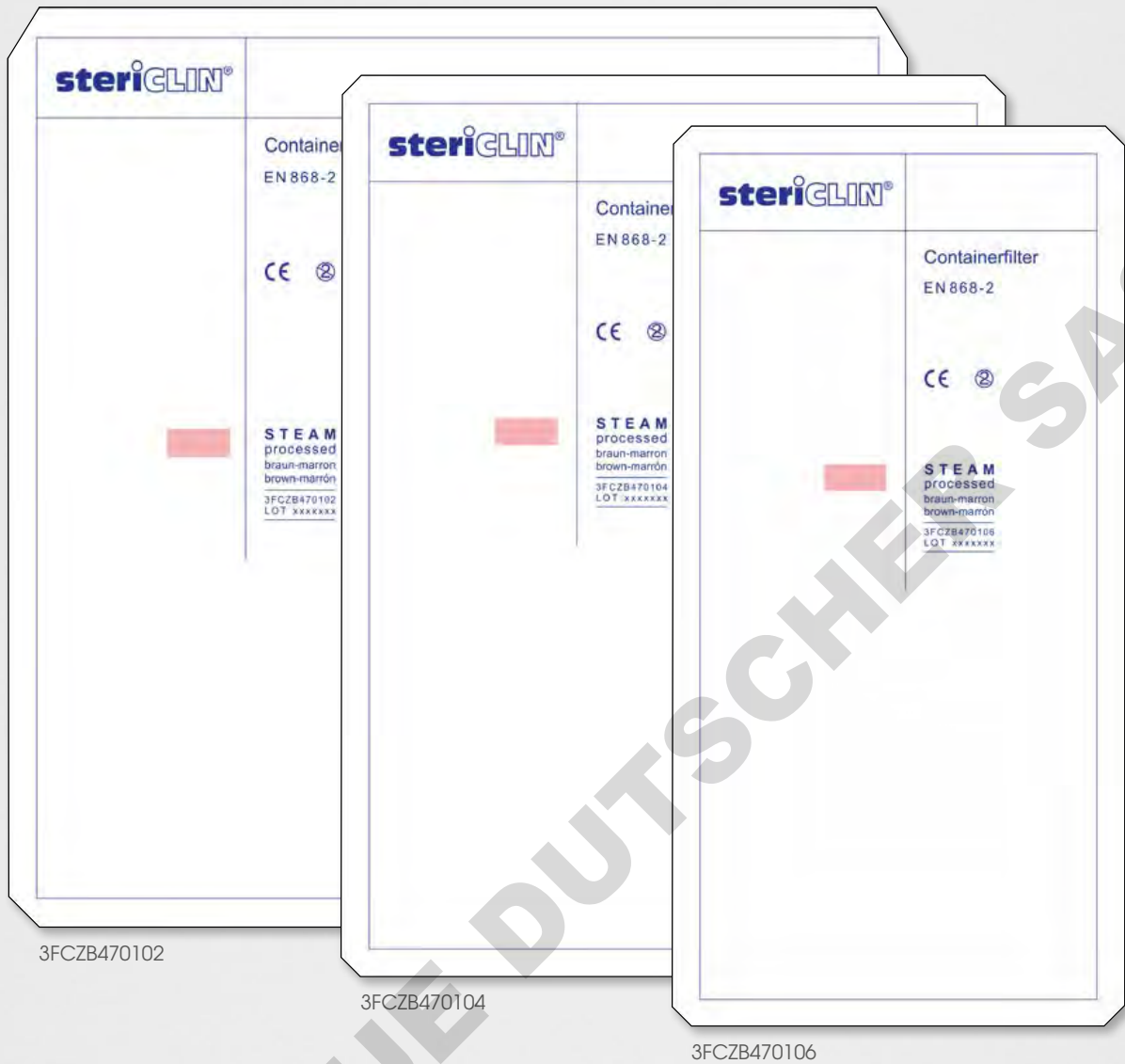

Stericlin® container filters

The reliable barrier against germs and bacteria

Stericlin® container filters form a reliable barrier against germs and bacteria. The material meets the requirements of EN ISO 11607 and EN 868-2. Made for single use only, they guarantee reproducible quality. An extra benefit comes with their high efficiency.

We can implement other dimensions or special requirements for you individually. Please contact us, we will advise you.

Article No.	Container type	Description	Pack (pcs.)
3FCZB470102	Aesculap	rectangular, made of paper, with print + STEAM indicator, size: 230 × 230 mm, sloped edges	500
3FCZB470104	Aesculap	rectangular, made of paper, with print + STEAM indicator, size: 171 × 232 mm, sloped edges	1000
3FCZB470106	Aesculap	rectangular, made of paper, with print + STEAM indicator, size: 118 × 235 mm, sloped edges	1000



3FSZB730102



3FSZB730104



3FSZB730120

Stericlin® instrument protection made of paper and film

The protection for high-quality instruments against damage

The stericlin® InstruProtector is intended to protect small and sensitive instruments during sterilisation and keeps them in place. In addition, the InstruProtector helps to prevent damage to the sterile barrier system (e.g. see-through packaging).

Forceps, knife handles, probes – instrument bags from stericlin® help organise and optimally protect all small components for sterilisation in a tray or see-through packaging. After assembly, the instrument bags can be folded or rolled up and sterilised well protected in the tray or in see-through packaging.

Please note: Instrument bags have no barrier function, therefore they do not replace a sterile barrier system at all.

Article No.	Description	Pack (pcs.)
3FSZB730102	InstruProtector, size: 51 × 127 mm	250
3FSZB730104	InstruProtector, size: 90 × 168 mm	100
3FSZB730120	Instrument bag, with STEAM-Indicator, size: 520 × 210 mm	250



Stericlin® highline instrument protection caps

Protection against damage for points and edges

Stericlin® Highline instrument protection caps are available in different versions, and are specially designed for instrument protection. The easy-to-use protective caps, are protecting the tips and edges of the instruments from damage during sterilisation and transport. In addition, highline protective caps help to prevent damage to the sterile barrier system (e.g. transparent packaging) and cut and stab injuries to employees.

In order to increase patient safety, we deliberately refrain from punching holes in stericlin® Highline instrument protection caps, as these cannot be produced completely without burrs according to current state-of-the-art technology. Especially when using sharp-edged instruments, it cannot be ruled out that particles become separated from the holes in the protective cap. In order to be able to ensure that the sterilisation medium flows around the instruments very well, even without perforating the protective cap, the protective caps are equipped with internal knobs. These prevent the protective caps from being too tight and fully adhered on the instruments and subsequently reliably enable successful sterilisation.

All versions are suitable for steam sterilisation.



3FSZB730450



3FSZB730446



3FSZB730448



3FSZB730441



3FSZB730443



3FSZB730445

Article No.	Description	Size in mm	Colour (translucent)	Pack (pcs.)
3FSZB730456	Round cap	1,6 × 19	white	100
3FSZB730420	Round cap	1,6 × 19	clear	100
3FSZB730458	Round cap	2 × 19	blue	100
3FSZB730422	Round cap	2 × 19	clear	100
3FSZB730460	Round cap	2,8 × 19	green	100
3FSZB730424	Round cap	2,8 × 19	clear	100
3FSZB730462	Round cap	3,2 × 25,4	red	100
3FSZB730426	Round cap	3,2 × 25,4	clear	100
3FSZB730464	Round cap	5 × 25	yellow	100
3FSZB730428	Round cap	5 × 25	clear	100
3FSZB730411	Round cap	10 × 19	violet	100
3FSZB730413	Round cap	10 × 19	clear	100
3FSZB730452	Flat cap	6,4 × 19	clear	50
3FSZB730454	Flat cap	2 × 9 × 25	clear	100
3FSZB730444	Flat cap	2 × 9 × 25	orange	100
3FSZB730440	Flat cap	12,7 × 25	clear	50
3FSZB730468	Flat cap	2 × 16 × 25	brown	100
3FSZB730466	Flat cap	2 × 16 × 25	clear	100
3FSZB730450	Flat cap	19 × 25,4	clear	50
3FSZB730446	Flat cap	3 × 25 × 25	clear	100
3FSZB730448	Flat cap	3 × 25 × 25	black	100
3FSZB730441	Flat cap	32 × 32	clear	50
3FSZB730443	Flat cap	38 × 38	clear	50
3FSZB730445	Flat cap	32 × 44,5	clear	50



Why our protection caps are not perforated?

Contamination due to cutting residues

During internal inspections, it became apparent that in the case of perforated protective caps, which represent the most common product group on the market, production surpluses (burrs) are visible in the punched holes. This is mainly due to the punching process, which as a rule cannot be carried out completely without residues. These tiny particles/residues bear the risk of falling off during the use of the protective cap and instrument, remaining on the instrument and, in the worst case, getting into the patient during an operation or wound treatment.

Basically, punched holes give the impression that holes ensure a safe sterilisation result. The impression can arise that steam flows through the holes under the cap or onto the instrument surface and ensures a safe sterilisation result. This is only partial correct!

Only the correct selection of the protective cap size gives the possibility to achieve sufficient steam circulation around the instrument. In reality, this can lead to perforated protective caps sitting too lightly on the instrument and therefore falling off during the process.

To avoid these risks, we have turned to new designs and manufacturing processes and have chosen protective caps with inner nubs because of their clear advantages. The nub protection cap reduces the risk of choosing too small cap sizes, as even with a tighter fitting nub protection cap, the nubs minimize the contact area which allows steam to still flow around the instrument. We have proven the sterilisation success through sterilisation validations by an independent laboratory.



3FSZB730429



3FSZB730431



3FSZB730430



3FSZB730432



3FSZB730434



3FSZB730435



3FSZB730486



3FSZB730488



3FSZB730490

Article No.	Description	Size in mm	Colour (translucent)	Pack (pcs.)
3FSZB730470	Pointed cap	Ø: 2 – 3 / length: 38	white	70
3FSZB730472	Pointed cap	Ø: 3 – 4 / length: 38	blue	70
3FSZB730474	Pointed cap	Ø: 4 – 5 / length: 38	green	70
3FSZB730476	Pointed cap	Ø: 5 – 6 / length: 38	red	70
3FSZB730477	Pointed cap	Ø: 6 – 7 / length: 38	yellow	70
3FSZB730478	Pointed cap	Ø: 7 – 8 / length: 38	violet	70
3FSZB730480	Pointed cap	Ø: 2 – 3 / length: 51	white	70
3FSZB730482	Pointed cap	Ø: 3 – 4 / length: 51	blue	70
3FSZB730483	Pointed cap	Ø: 4 – 5 / length: 51	green	70
3FSZB730484	Pointed cap	Ø: 5 – 6 / length: 51	red	70
3FSZB730485	Pointed cap	Ø: 6 – 7 / length: 51	yellow	70
3FSZB730487	Pointed cap	Ø: 7 – 8 / length: 51	violet	70
3FSZB730429	Twin cap	1,6 × 19	white	50
3FSZB730431	Twin cap	2 × 19	blue	50
3FSZB730430	Twin cap	2,8 × 19	green	50
3FSZB730432	Twin cap	3,2 × 25	red	50
3FSZB730434	Twin cap	5 × 25	yellow	50
3FSZB730435	Twin cap	2 × 9 × 25	orange	50
3FSZB730486	Retractor cap	13 × 25	violet	50
3FSZB730488	Retractor cap	13 × 25	clear	50
3FSZB730490	Retractor cap	13 × 32	clear	50



Stericlin® cable ties made of silicone

Useful in many applications: bundling, attaching, marking...

Our stericlin® silicone cable ties are produced in compliance with the highest quality standards. They protect your instruments and create clear structures in your instrument trays. In addition, stericlin® cable ties allow colour coding of instrument trays, transport baskets, etc.

High resistance properties ensure that all common cleaning, disinfection and sterilisation processes can be used - at temperatures up to 230°C.

The stericlin® cable ties are designed to securely fix a wide range of diameters of instrument bundles. The silicone material has a high elasticity and therefore prevents damage to your instruments during bundling.

Stericlin® silicone cable ties are available in various lengths, colours and designs to meet all requirements. All variants have locking teeth along the entire length, as well as two eyelets on each headpiece. This allows very versatile mounting options. For a better grip and easy opening, the head piece is also fitted with grooves.

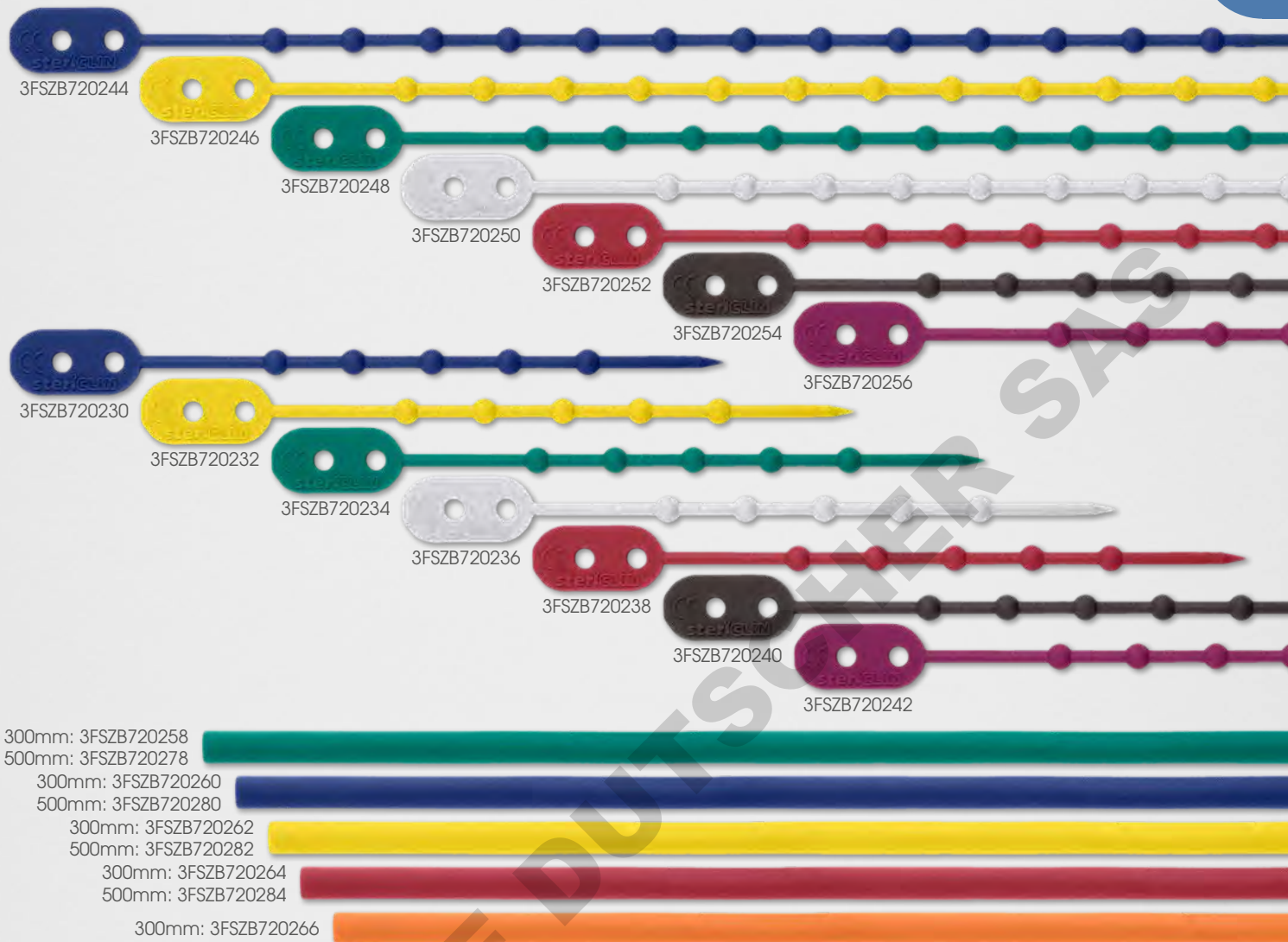

Article No.	Description	Size (length)	Pack (pcs.)
3FSZB720202	flat, blue	190 mm	100
3FSZB720204	flat, yellow	190 mm	100
3FSZB720206	flat, green	190 mm	100
3FSZB720208	flat, transparent	190 mm	100
3FSZB720210	flat, orange	190 mm	100
3FSZB720212	flat, red	190 mm	100
3FSZB720214	flat, black	190 mm	100
3FSZB720216	flat, blue	110 mm	100
3FSZB720218	flat, yellow	110 mm	100
3FSZB720220	flat, green	110 mm	100
3FSZB720222	flat, transparent	110 mm	100
3FSZB720224	flat, orange	110 mm	100
3FSZB720226	flat, red	110 mm	100
3FSZB720228	flat, black	110 mm	100
3FSZB720286	flat, mint	60 mm	100
3FSZB720288	flat, blue	60 mm	100
3FSZB720290	flat, yellow	60 mm	100
3FSZB720292	flat, green	60 mm	100
3FSZB720294	flat, red	60 mm	100
3FSZB720244	round, blue	210 mm	100
3FSZB720246	round, yellow	210 mm	100

Article No.	Description	Size (length)	Pack (pcs.)
3FSZB720248	round, green	210 mm	100
3FSZB720250	round, transparent	210 mm	100
3FSZB720252	round, red	210 mm	100
3FSZB720254	round, black	210 mm	100
3FSZB720256	round, violet	210 mm	100
3FSZB720230	round, blue	110 mm	100
3FSZB720232	round, yellow	110 mm	100
3FSZB720234	round, green	110 mm	100
3FSZB720236	round, transparent	110 mm	100
3FSZB720238	round, red	110 mm	100
3FSZB720240	round, black	110 mm	100
3FSZB720242	round, violet	110 mm	100
3FSZB720258	bundle strings, flat, green	300 mm	100
3FSZB720260	bundle strings, flat, blue	300 mm	100
3FSZB720262	bundle strings, flat, yellow	300 mm	100
3FSZB720264	bundle strings, flat, red	300 mm	100
3FSZB720266	bundle strings, flat, orange	300 mm	100
3FSZB720278	bundle strings, flat, green	500 mm	100
3FSZB720280	bundle strings, flat, blue	500 mm	100
3FSZB720282	bundle strings, flat, yellow	500 mm	100
3FSZB720284	bundle strings, flat, red	500 mm	100



3FSZB830102

3FSZB830103
3FSZB830104

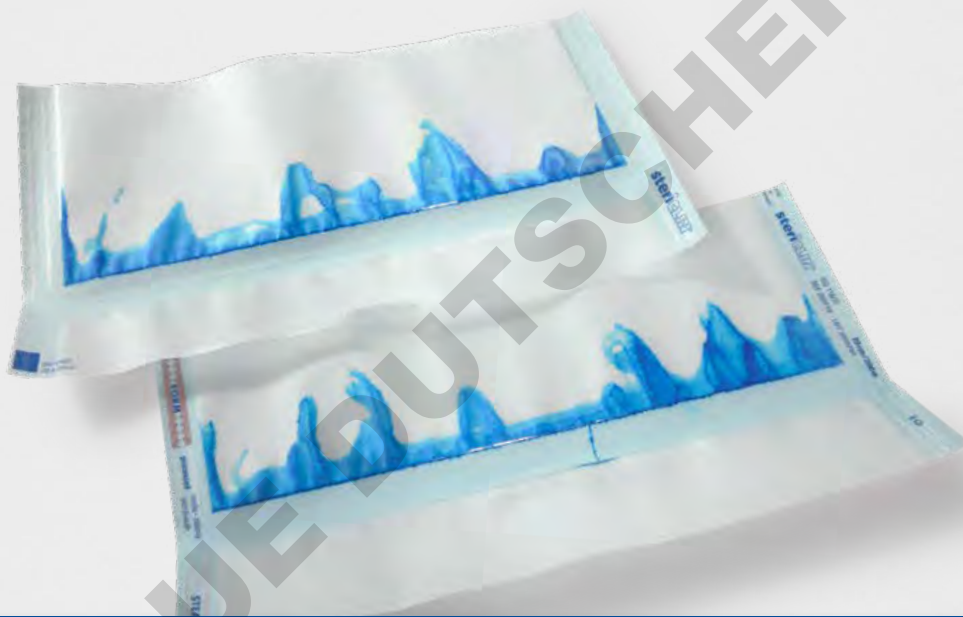

Stericlin® seal seam integrity tests

For routine testing of seal seams according to EN ISO 11607

Stericlin® seal seam integrity tests are easy to perform and detect quickly channels and voids of the seal seam. In combination with the Seal Test they offer the comprehensive and secure routine testing for the heat sealing process.

For specifications, see the DGSV guidelines for the validation of packaging processes according to EN ISO 11607-2. The use of ink tests is required in Appendix A.7.3 and A.7.4 (page 23/24).

We offer the seal seam integrity tests in two basic versions: „pipette“ and „disposable ink bag“.

Our seal seam integrity tests are free of Triton X.

Article No.	Description	Pack (pcs.)
3FSZB830102	Seal seam integrity test (75 ml) pipette, EN ISO 11607/ASTM F1929	1
3FSZB830103	Seal seam integrity test „Liquid Control“, disposable ink bag, EN ISO 11607/ASTM F1929, for see-through packaging made of paper and film	30
3FSZB830104	Seal seam integrity test „Liquid Control“, disposable ink bag, EN ISO 11607, for see-through packaging made of polyolefins (DuPont™ Tyvek®) and film, and for see-through packaging made of PP non-woven and film	30



Stericlin® seal tests

For routine testing of seal seams according to EN ISO 11607

The Stericlin® Seal Test is used for routine testing of the seal device, showing irregularities and damage clearly in the seam. In combination with the seal seam integrity test it offers the most comprehensive and reliable routine examination for the heat sealing process.

For specifications, see the DGSV guidelines for the validation of packaging processes according to EN ISO 11607-2. The use of seal tests is required in Appendix A.7.2 (page 22).

Article No.	Description	Pack (pcs.)
3FSZB830106	Seal test paper, EN ISO 11607	250
3FSZB830107	Seal test PP non-woven, EN ISO 11607	125
3FSZB830108	Seal test DuPont™ Tyvek®, EN ISO 11607	125



Stericlin® dust cover bags for sterile barrier systems

The protective packaging with self-adhesive closure

Dust cover bags from Stericlin® offer reliable protection packaging for sterile goods and sterile barrier systems during transport and storage. They extend the possible storage period of sterile medical devices.

Article No.	Size in cm (width × length)	Pack (pcs.)
3FSSV510102	20 × 30	1000
3FSSV510106	25 × 40	500
3FSSV510108	25 × 120	500
3FSSV510110	30 × 50	500
3FSSV510112	42 × 70	500
3FSSV510114	60 × 50	100
3FSSV510116	60 × 75	100
3FSSV510118	70 × 100	100

3FSSV512101

3FSSV512102

3FSSV512110

Stericlin® safety bags for disinfected medical devices

According to the recommendation of DGSV's Quality Task Group (90)

The safety bag from stericlin® reliably protects your disinfected medical devices from recontamination. Gamma sterilization after production ensures that the safety bags are germ-free on the inside. The bag fulfils and exceeds the 2015 recommendations of DGSV's Quality Task Group (90).

Article No.	Size in mm (width × length)	Pack (pcs.)
3FSSV512101	197 × 170	500
3FSSV512102	197 × 300	500
3FSSV512106	247 × 390	500
3FSSV512110	297 × 500	500
3FSSV512112	413 × 460	500
3FSSV512114	623 × 550	200



3FSSV514102

3FSSV514106

Stericlin® safety bags for explants

The transport and storage packaging for extracted implants

Implants are the property of the patient and must be handed on request after extraction. Our stericlin® safety bags for explants are used for transport and storage of remote implants.

Article No.	Size in mm (width × length)	Pack (pcs.)
3FSSV514102	197 × 170	100
3FSSV514104	197 × 300	100
3FSSV514106	197 × 600	100



Stericlin® hygiene wipes

Compatible with commercially available disinfectants

Stericlin® hygiene wipes made of 100% microfibre are compatible with commercially available disinfectants, lint-free and are characterised by outstanding cleaning and absorption performance.

The absorption capacity amounts 850% at a base weight of 60 g/m².

Please note that the hygiene wipes are intended for single use only.

Article No.	Description	Pack (pcs.)
3FSZB790120	Hygiene wipes microfibre (disposable), colour: white, size: 305 x 340 mm, pack: 8 x 40 pcs.	320



Stericlin® hygiene and waste bags

An easy solution for disposal

Stericlin® waste bags can be used in a variety of ways for disposal and can be adhered with the adhesive strip on the back, e.g. to the patient's bed.

Article No.	Description	Pack (pcs.)
3FSZB710130	Waste bags with adhesive strip on the back, material: foil (LDPE), size: 22 x 25 cm	1000

Labeling / documentation



Identification, controlling, documenting and tracking of sterile barrier systems and medical devices

Make responsibility towards your patients visible - each sterilisation control must meet this claim and allow an easy and economical documentation that can be tracked in the patient record. We have set ourselves this claim in the design of our products. Convince yourself of stericlin®! We provide a variety of self-adhesive labels and thermal transfer films for all common thermal transfer printers and documentation systems, indicator strips and labels for manual labelling of sterilisation types STEAM, EO, FORM, VH2O2 (plasma) and irradiation.

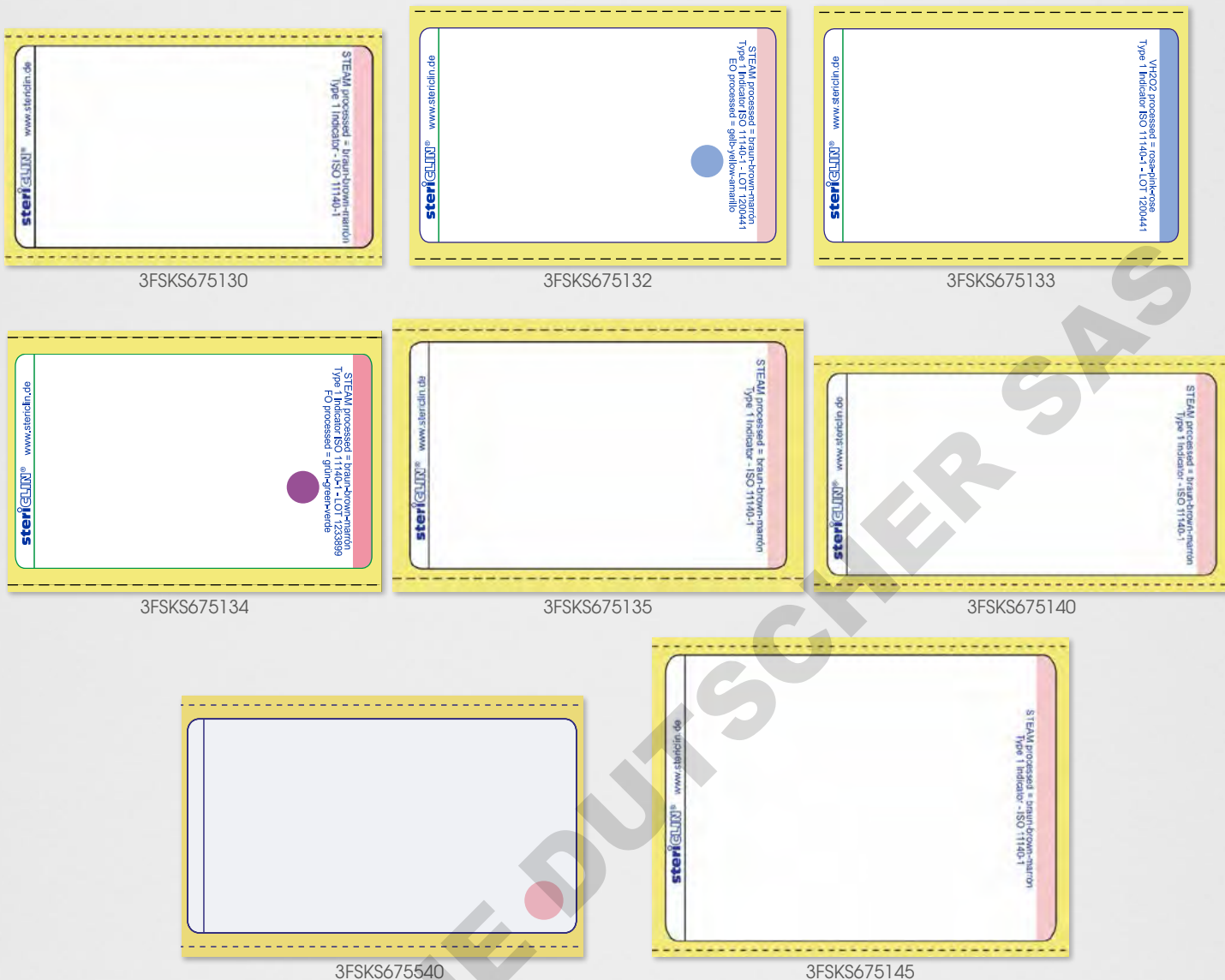

Stericlin® self-adhesive labels, single, in different formats

Sterilisation-proof marking and documentation of medical devices

Barcode labels from Stericlin® are used with thermal transfer printers. For the "single" type we have an extensive assortment with different formats and splits, to match your use. Stericlin® labels are available with or without indicator, single or double self-adhesive.

Article No.	Material	Winding direction	Description	Pack (pcs.)
3FSKS675130	Paper	inside	with STEAM indicator, double self-adhesive (sandwich), size: 55 x 31 mm, core: 40 mm, roll width: 58 mm	10000 (roll at 1000)
3FSKS675132	Paper	outside	with STEAM and EO indicator, double self-adhesive (sandwich), size: 55 x 33 mm, core: 40 mm, roll width: 58 mm	10000 (roll at 1000)
3FSKS675133	Film	outside	with VH2O2 indicator, double self-adhesive (sandwich), size: 55 x 33 mm, core: 40 mm, roll width: 58 mm	10000 (roll at 1000)
3FSKS675134	Paper	outside	with STEAM and FORM indicator, double self-adhesive (sandwich), size: 55 x 33 mm, core: 40 mm, roll width: 58 mm	10000 (roll at 1000)
3FSKS675135	Paper	inside	with STEAM indicator, double self-adhesive (sandwich), size: 58 x 35 mm, core: 40 mm, roll width: 63 mm	10000 (roll at 1000)
3FSKS675140	Paper	inside	with STEAM indicator, double self-adhesive (sandwich), size: 60 x 31 mm, core: 40 mm, roll width: 64 mm	10000 (roll at 1000)



3FSKS675150



3FSKS675153



3FSKS675155 / 3FSKS675156



3FSKS675158 / 3FSKS675159



3FSKS675162

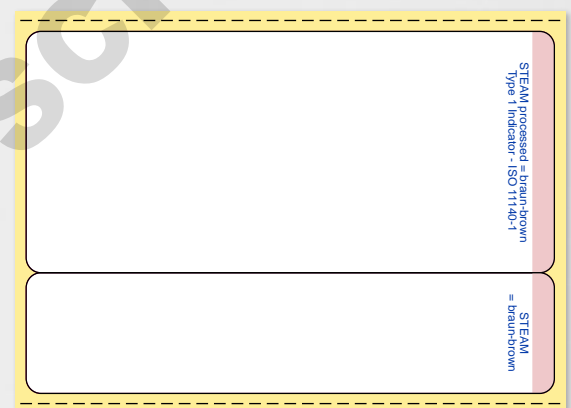

3FSKS675163 / 3FSKS675164

Article No.	Material	Winding direction	Description	Pack (pcs.)
3FSKS675540	Vellum	inside	with STEAM indicator, double self-adhesive (sandwich), size: 60 x 33 mm, core: 40 mm, roll width: 62 mm	10000 (roll at 1000)
3FSKS675145	Paper	inside	with STEAM indicator, double self-adhesive (sandwich), size: 60 x 44 mm, core: 40 mm, roll width: 64 mm	10000 (roll at 1000)
3FSKS675150	Paper	inside	with STEAM indicator, double self-adhesive (sandwich), size: 63 x 40 mm, core: 40 mm, roll width: 67 mm	10000 (roll at 1000)
3FSKS675153	DuPont™ Tyvek®	inside	with VH2O2 indicator, double self-adhesive (sandwich), size: 70 x 35 mm, core: 40 mm, roll width: 73 mm	2000 (roll at 1000)
3FSKS675155	Paper	inside	with STEAM indicator, double self-adhesive (sandwich), size: 70 x 35 mm, core: 40 mm, roll width: 73 mm	10000 (roll at 1000)
3FSKS675156	Paper	inside	with STEAM indicator, double self-adhesive (sandwich), size: 70 x 35 mm, core: 76 mm, roll width: 73 mm	10000 (roll at 1000)
3FSKS675158	Paper	inside	without print / without indicator, double self-adhesive (sandwich), size: 75 x 35 mm, core: 40 mm, roll width: 78 mm	10000 (roll at 1000)
3FSKS675159	Paper	inside	without print / without indicator, double self-adhesive (sandwich), size: 75 x 35 mm, core: 76 mm, roll width: 78 mm	10000 (roll at 1000)
3FSKS675162	Paper	inside	with STEAM indicator, double self-adhesive (sandwich), size: 70 x 48 mm, core: 40 mm, roll width: 73 mm	10000 (roll at 1000)
3FSKS675163	Paper	outside	with STEAM indicator, double self-adhesive (sandwich), size: 72 x 48 mm, core: 76 mm, roll width: 75 mm, split horizontal in top material (= 72 x 16 mm + 72 x 32 mm)	10000 (roll at 1000)
3FSKS675164	Paper	outside	with STEAM indicator, double self-adhesive (sandwich), size: 72 x 48 mm, core: 72 mm, roll width: 75 mm, split horizontal in top material (= 72 x 16 mm + 72 x 32 mm)	10000 (roll at 1000)

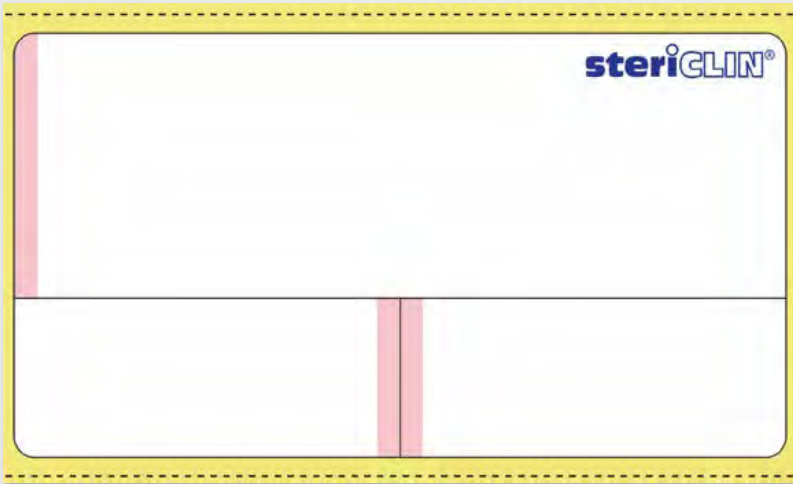

3FSKS675558 / 3FSKS675165 / 3FSKS675166



3FSKS675170



3FSKS675175

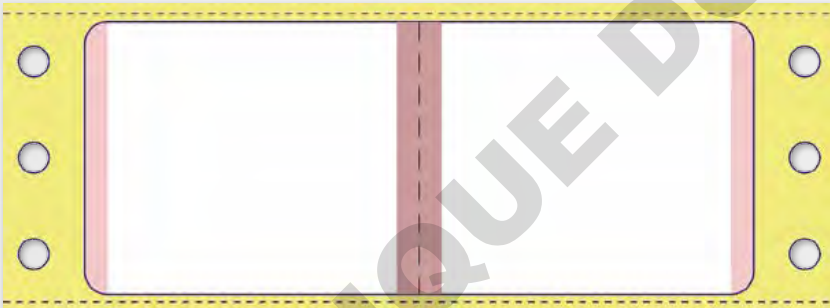

3FSKS675180

Article No.	Material	Winding direction	Description	Pack (pcs.)
3FSKS675558	Paper	outside	with STEAM indicator, double self-adhesive (sandwich), size: 102 x 56 mm, core: 25 mm, roll width: 105 mm, split in T-shape in top material (= 102 x 35 mm + 51 x 21 mm x 2)	8000 (roll at 800)
3FSKS675165	Paper	inside	with STEAM indicator, double self-adhesive (sandwich), size: 102 x 56 mm, core: 76 mm, roll width: 105 mm, split in T-shape in top material (= 102 x 35 mm + 51 x 21 mm x 2)	10000 (roll at 1000)
3FSKS675166	Paper	outside	with STEAM indicator, double self-adhesive (sandwich), size: 102 x 56 mm, core: 76 mm, roll width: 105 mm, split in T-shape in top material (= 102 x 35 mm + 51 x 21 mm x 2)	10000 (roll at 1000)
3FSKS675170	Paper	outside	with STEAM indicator, single self-adhesive, size: 70 x 38,1 mm, core: 40 mm, roll width: 70 mm, 3 mm width control bar for printer on back side	10000 (roll at 1000)
3FSKS675175	Paper	outside	with STEAM indicator, single self-adhesive, size: 88,5 x 36 mm, core: 40 mm, roll width: 110 mm, centrally perforated, with remainer	10000 (roll at 1000)
3FSKS675180	Paper	outside	with STEAM and FORM indicator, single self-adhesive, size: 88,5 x 36 mm, core: 40 mm, roll width: 110 mm, centrally perforated, with remainer	10000 (roll at 1000)

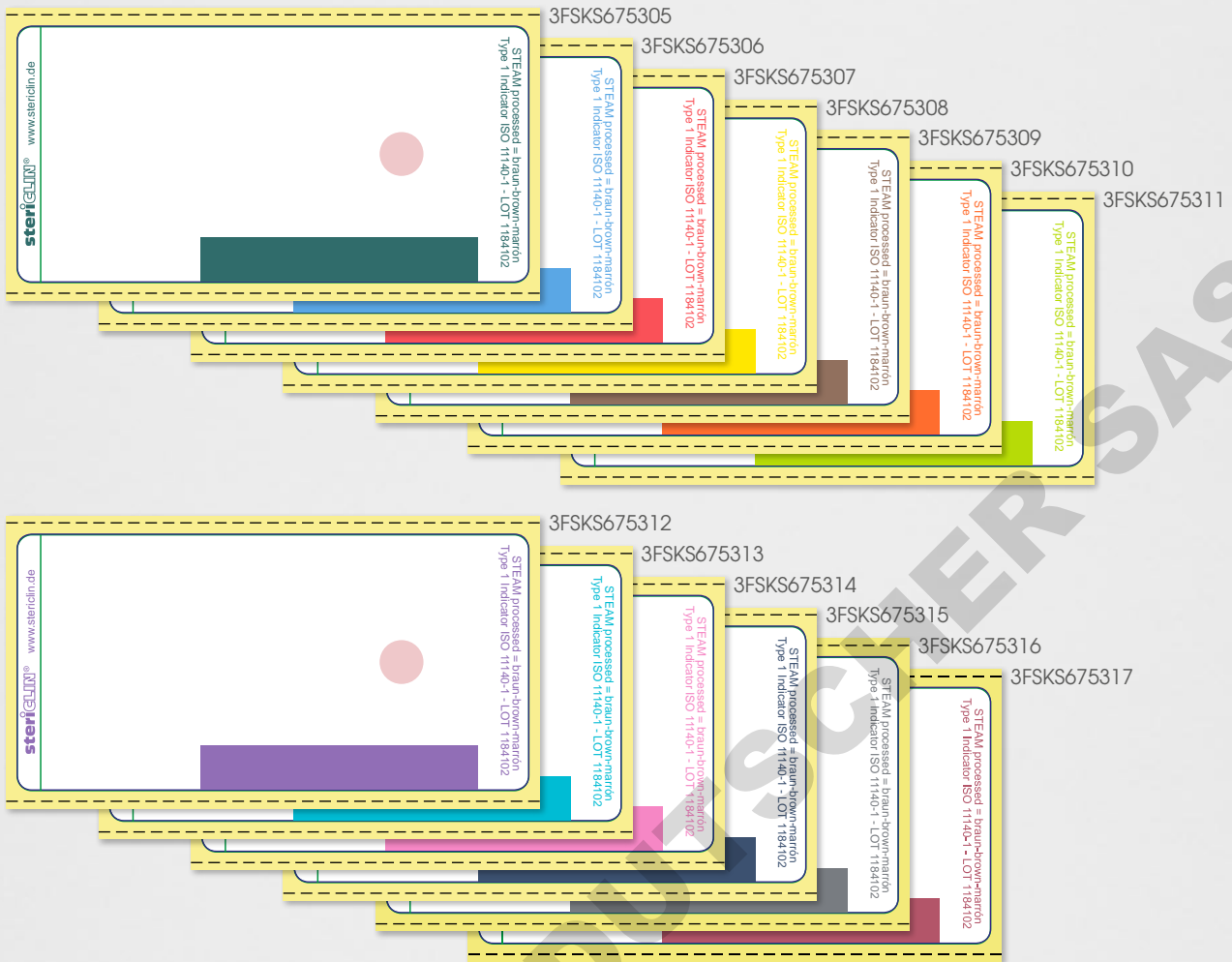

Stericlin® self-adhesive labels for colour differentiation

Sterilisation-proof marking and documentation of medical devices

Barcode labels from steriCLIN® are used with thermal transfer printers. For colour differentiation, such as for expiry dates on your medical device packaging, one size of the steriCLIN® self-adhesive labels with STEAM indicator is now available in 13 different types. You can specify the sequence or the assigned month according to your needs.

Every variant has a STEAM indicator and all labels are double self-adhesive (sandwich) and wound on the inside.

Article No.	Material	Colour	Description	Pack (pcs.)
3FSKS675305	Paper	green	size: 70 × 35 mm, core: 40 mm, reel width: 73 mm	10000 (roll at 1000)
3FSKS675306	Paper	blue	size: 70 × 35 mm, core: 40 mm, reel width: 73 mm	10000 (roll at 1000)
3FSKS675307	Paper	red	size: 70 × 35 mm, core: 40 mm, reel width: 73 mm	10000 (roll at 1000)
3FSKS675308	Paper	yellow	size: 70 × 35 mm, core: 40 mm, reel width: 73 mm	10000 (roll at 1000)
3FSKS675309	Paper	brown	size: 70 × 35 mm, core: 40 mm, reel width: 73 mm	10000 (roll at 1000)
3FSKS675310	Paper	orange	size: 70 × 35 mm, core: 40 mm, reel width: 73 mm	10000 (roll at 1000)
3FSKS675311	Paper	light green	size: 70 × 35 mm, core: 40 mm, reel width: 73 mm	10000 (roll at 1000)
3FSKS675312	Paper	violet	size: 70 × 35 mm, core: 40 mm, reel width: 73 mm	10000 (roll at 1000)
3FSKS675313	Paper	cyan	size: 70 × 35 mm, core: 40 mm, reel width: 73 mm	10000 (roll at 1000)
3FSKS675314	Paper	pink	size: 70 × 35 mm, core: 40 mm, reel width: 73 mm	10000 (roll at 1000)
3FSKS675315	Paper	dark blue	size: 70 × 35 mm, core: 40 mm, reel width: 73 mm	10000 (roll at 1000)
3FSKS675316	Paper	gray	size: 70 × 35 mm, core: 40 mm, reel width: 73 mm	10000 (roll at 1000)
3FSKS675317	Paper	burgundy	size: 70 × 35 mm, core: 40 mm, reel width: 73 mm	10000 (roll at 1000)

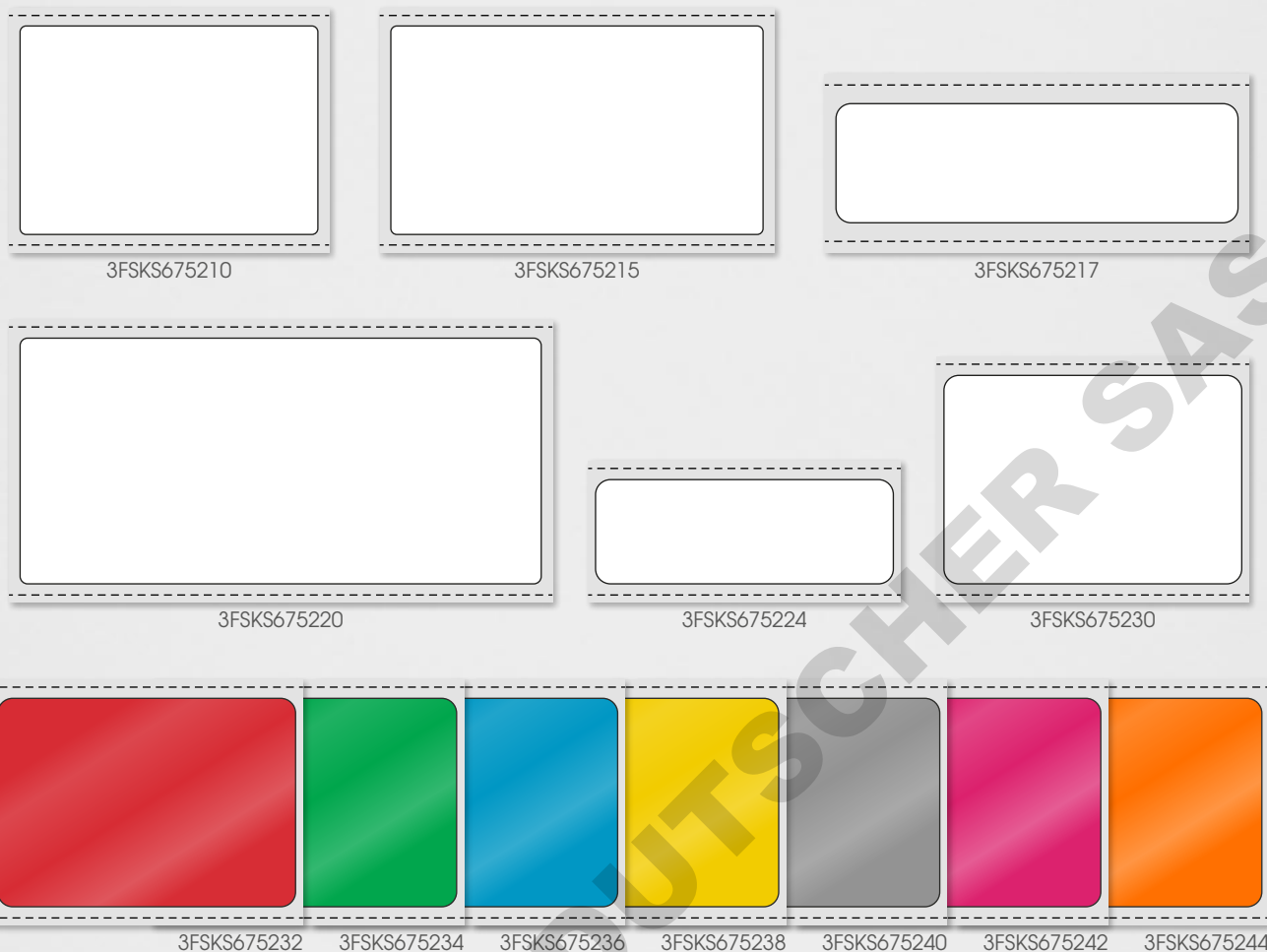

Stericlin® self-adhesive labels for permanent marking

Cleaning, disinfection-resistant and sterilisation-proof, for permanent marking

Barcode labels from stericlín® are used with thermal transfer printers. For permanent marking of medical devices, stericlín® self-adhesive labels are made of film material, without indicator. For printing, use our AXR® 8 thermal transfer film - it is perfect for this usage.

Article No.	Material	Colour	Winding direction	Description	Pack (pcs.)
3FSKS675210	Film	white	inside	size: 40 x 28 mm, core: 40 mm, reel width: 43 mm	1000
3FSKS675215	Film	white	inside	size: 50 x 28 mm, core: 40 mm, reel width: 53 mm	1000
3FSKS675217	Film	white	inside	size: 54 x 16 mm, core: 40 mm, reel width: 57 mm	1000
3FSKS675220	Film	white	outside	size: 70 x 33 mm, core: 40 mm, reel width: 73 mm	1000
3FSKS675224	Film	white	outside	size: 40 x 14 mm, core: 40 mm, reel width: 42 mm	1000
3FSKS675230	Film	white	outside	size: 40 x 28 mm, core: 40 mm, reel width: 42 mm	1000
3FSKS675232	Film	red	outside	size: 40 x 28 mm, core: 40 mm, reel width: 42 mm	1000
3FSKS675234	Film	green	outside	size: 40 x 28 mm, core: 40 mm, reel width: 42 mm	1000
3FSKS675236	Film	blue	outside	size: 40 x 28 mm, core: 40 mm, reel width: 42 mm	1000
3FSKS675238	Film	yellow	outside	size: 40 x 28 mm, core: 40 mm, reel width: 42 mm	1000
3FSKS675240	Film	silver	outside	size: 40 x 28 mm, core: 40 mm, reel width: 42 mm	1000
3FSKS675242	Film	pink	outside	size: 40 x 28 mm, core: 40 mm, reel width: 42 mm	1000
3FSKS675244	Film	orange	outside	size: 40 x 28 mm, core: 40 mm, reel width: 42 mm	1000

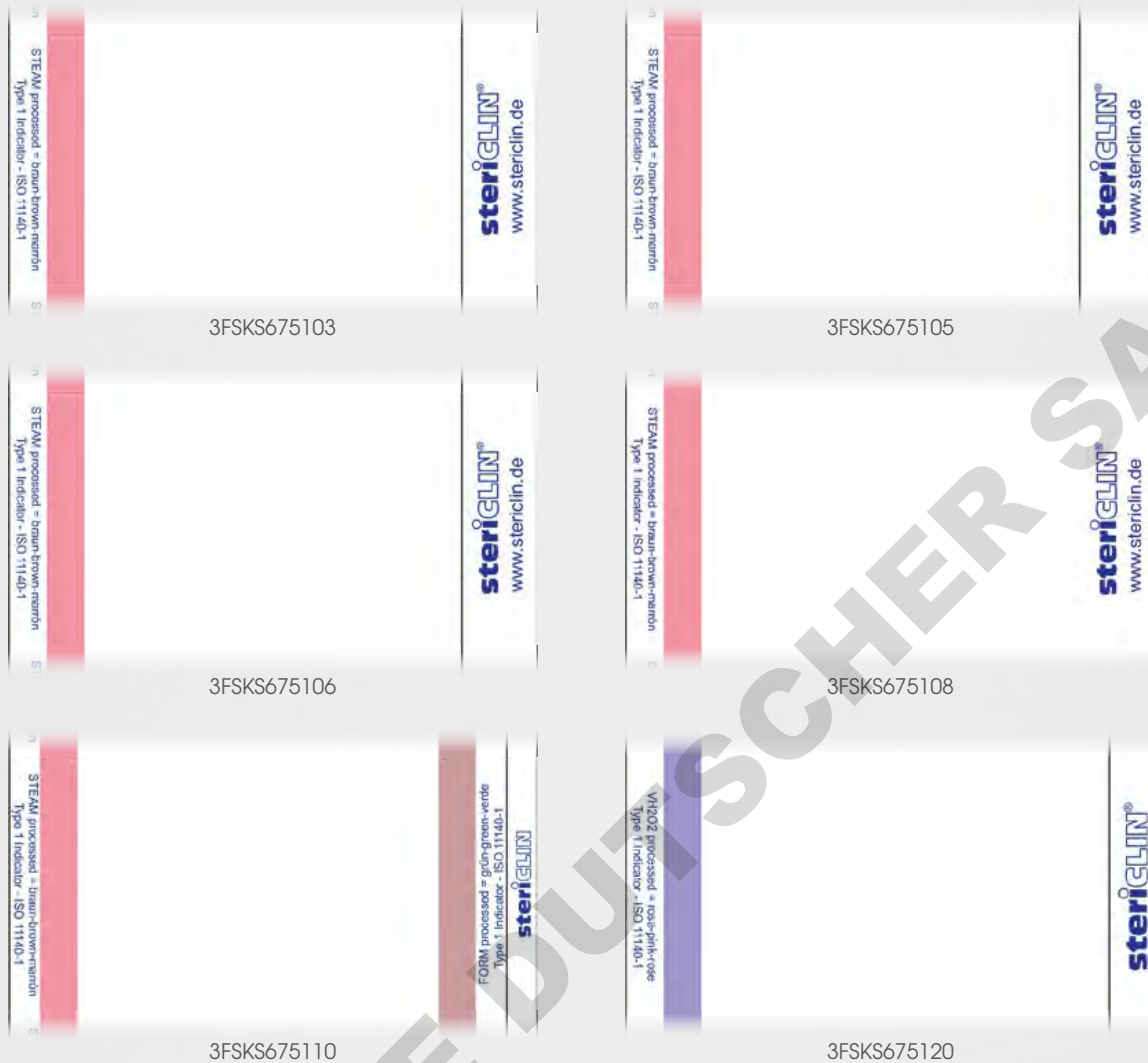

Stericlin® self-adhesive labels, continuous roll

Sterilisation-proof marking and documentation of medical devices

Barcode labels from stericlin® are used with thermal transfer printers. For the „continuous roll“ type, you specify the length of the individual labels that matches your usage. Stericlin® labels are available with or without indicator, single or double, self-adhesive.

Article No.	Material	Winding direction	Description	Pack (pcs.)
3FSKS675103	Paper	outside	with STEAM indicator, double self-adhesive (sandwich), modified adhesive (less adhesion), roll width: 70 mm, core: 50 mm, roll length: 80 m	5 reels
3FSKS675105	Paper	outside	with STEAM indicator, double self-adhesive (sandwich), roll width: 70 mm, core: 50 mm, roll length: 80 m	5 reels
3FSKS675106	Paper	outside	with STEAM indicator, double self-adhesive (sandwich), roll width: 70 mm, core: 76 mm, roll length: 80 m	5 reels
3FSKS675108	Paper	outside	with STEAM indicator, single self-adhesive, roll width: 70 mm, core: 50 mm, roll length: 80 m	5 reels
3FSKS675110	Paper	outside	with STEAM and FORM indicator, double self-adhesive (sandwich), roll width: 70 mm, core: 50 mm, roll length: 80 m	5 reels
3FSKS675120	DuPont™ Tyvek®	outside	with VH2O2 (PLASMA) indicator, double self-adhesive (sandwich), roll width: 70 mm, core: 50 mm, roll length: 40 m	5 reels



3FSZB670202



3FSKS670210

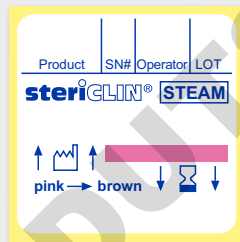

3FSKS670212

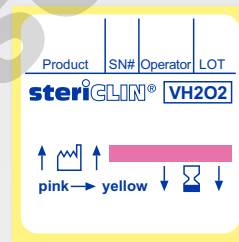

3FSKS670216

Hand labelling device with accessories

Easy, reliable and quick documentation

Our stericlin® hand labelling device with matching special labels is perfect for tracing and documenting medical products. All packaged sterilised goods are given a label with unique identification: product, serial number, employee, LOT number, date of manufacture and expiration date. After use in the OR the double self-adhesive labels can be peeled off the package and stuck in the patient file. This guarantees full traceability.

The stericlin® hand labelling device has a printing mechanism with 3 lines and 11 numbers each. This means that information such as product, employee, serial number, and LOT number can be applied coded to the label. The date of manufacture and expiration can be printed out in clear format.

Special labels for the stericlin® hand labelling device are available either without indicator or with Type 1 indicator according to EN ISO 11140-1 for all common sterilisation methods. Each package of special labels already contains a suitable ink roll.

Article No.	Description	Size in mm	Pack (pcs.)
3FSZB670202	Hand labelling device, 3 lines		1 pc.
3FSKS670210	Self-adhesive labels without indicator, 500 pcs. per roll	29 x 28	5000 pcs. + ink roll
3FSKS670212	Self-adhesive labels with STEAM indicator, 500 pcs. per roll	29 x 28	5000 pcs. + ink roll
3FSKS670216	Self-adhesive labels with VH2O2 indicator, 500 pcs. per roll	29 x 28	2500 pcs. + ink roll

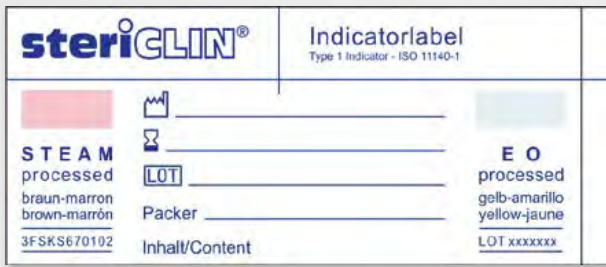

3FSKS670102



3FSKS670501



3FSKS670106



3FSKS670108



3FSKS670110



3FSKS670112



3FSKS670114

Stericlin® labels for manual labelling/marketing

Sterilisation-proof marking and documentation of medical devices

With our stericlin® documentation labels for manual inscription all medical devices and sterile barrier systems featuring can be easily and professionally marked and documented.

Article No.	Description	Pack (pcs.)
3FSKS670102	double self-adhesive, with STEAM and EO indicator, split in front and backing material as removal aid, size: 80 x 34 mm (single label), at 250 pcs. in a dispenser box	1000
3FSKS670501	single self-adhesive, with STEAM- and EO-Indicator, label format: 75 x 25 mm, (3000 labels per reel)	9000
3FSKS670106	single self-adhesive, with STEAM indicator, label format: 25 x 20 mm, (25 labels per sheet)	2500
3FSKS670108	single self-adhesive, with FORM indicator, label format: 25 x 20 mm, (25 labels per sheet)	2500
3FSKS670110	single self-adhesive, with EO indicator, label format: 25 x 20 mm, (25 labels per sheet)	2500
3FSKS670112	single self-adhesive, with VH202 (PLASMA) indicator, label format: 25 x 20 mm, (25 labels per sheet)	2500
3FSKS670114	single self-adhesive, GAMMA indicator adhesive dots on roll, size: 12,7 mm	5000



3FSKS680102



3FSKS680106

Stericlin® patient-related batch traceability documentation system

Sterilisation-proof marking and documentation of medical devices

With our stericlin® patient-related batch traceability documentation system you can easily and professionally ensure the traceability of medical devices and sterile barrier systems without the help of technical equipment.

This system can also provide a batch traceability documentation system as part of a failure concept (for example, failure of IT-based documentation).

Article No.	Description	Pack (pcs.)
3FSKS680102	Label, single self-adhesive, with STEAM indicator, with imprint and code, size: 92 x 40 mm, dispenser box at 250 pcs.	1000
3FSKS680106	Batch card, DIN A5, with STEAM indicator	1000



3FSZB710102

3FSZB710104

3FSZB710828

Stericlin® fibre-tip pens

For labelling of disposables

Sterile barrier systems, adhesive tapes, labels and more: The sterilisation-proof stericlin® fibre-tip pens have been developed for marking of a big variety of surfaces. We offer the pens in two colours with the line width „F“ (about 0,6 mm).

Please note: The inscription of see-through packaging may only take place on the film side and outside the filling area.

Article No.	Description	Pack (pcs.)
3FSZB710102	black	10
3FSZB710104	blue	10
3FSZB710828	red	25



Stericlin® info labels with imprint

Standardized labeling of medical devices

With our pre-printed stericlin® labels, you can indicate on specific features and characteristics of medical devices.

Article No.	Description	Pack (pcs.)
3FSZB710178	Stericlin® status label to indicate the hygiene status, removable without leaving any residue, size: 100 x 100 mm, core: 76 mm	1000
3FSZB710179	Stericlin® status label to indicate the hygiene status, removable without leaving any residue, size: 100 x 100 mm, core: 76 mm	500



Leihsieb
Loaner tray

3FSZB710202

unvollständig
incomplete

3FSZB710204

gereinigt & desinfiziert
cleaned & disinfected

3FSZB710206



3FSZB710180



3FSZB710182



3FSZB710190



3FSZB710192



3FSZB710194



3FSZB710176



3FSZB710177

ZU HÄNDEN DER
AEMP-LEITUNG



FOR THE ATTENTION OF
THE CSSD MANAGEMENT

3FSZB710195



3FSZB670220

Article No.	Description	Pack (pcs.)
3FSZB710202	Adhesive label, yellow, size 100 x 40 mm	500
3FSZB710204	Adhesive label, orange, size 100 x 40 mm	500
3FSZB710206	Adhesive label, light blue, size 100 x 40 mm	1000
3FSZB710180	Adhesive label, red, with safety perforation, size 80 x 25 mm	500
3FSZB710182	Adhesive label, red, with safety perforation, size 80 x 25 mm	500
3FSZB710190	Adhesive label, green, with safety perforation, size 80 x 25 mm	500
3FSZB710192	Adhesive label, green, with safety perforation, size 80 x 25 mm	500
3FSZB710194	Adhesive label, green, with safety perforation, size 80 x 25 mm	500
3FSZB710195	Status label, removable without leaving any residue, violet, size: 100 x 100 mm, core: 76mm	500
3FSZB710176	Status label, removable without leaving any residue, green, size: 100 x 100 mm, core: 76mm	500
3FSZB710177	Status label, removable without leaving any residue, red, size: 100 x 100 mm, core: 76mm	500
3FSZB670220	Label dispenser, made of metal, heavy duty, (maximum 216mm total width), for labels up to 77mm core diameter, dimensions: 230 x 220 x 130 mm (L x W x H), base: metal with suction cup and height adjustable feet	1



Stericlin® instrument tags

For quick identification of instruments in need of repair

For quick marking of instruments for information transfer between departments. Stericlin® repair tags are suitable for the entire reprocessing cycle due to their material properties and can be written on with fiber pens or affixed with labels. Custom configurations can also be manufactured upon customer request.

Article No.	Colour	Printing	Size	Pack (pcs.)
3FINS168202	orange	REPARATUR / REPAIR	110 x 15 mm	10 sheets with 10 pcs.
3FINS168204	blue	REPARIERT / REPAIRED	110 x 15 mm	10 sheets with 10 pcs.



Stericlin® thermal transfer films

The perfect complement for printing on stericlin® labels

The stericlin® APX® FH+ thermal transfer film is a high-end wax/resin ribbon. It provides an excellent transfer quality on all smooth surfaces of paper and film with low energy consumption.

The thermal transfer printing is on a stericlin® label of colour resistance during steam sterilisation according to EN 646 and EN 648. This is confirmed by an ISEGA report.

The stericlin® thermal transfer film AXR® 8 is suitable in combination with our stericlin® labels made of film for the permanent labelling of containers or instrument trays. The combination is stable in cleaning-/disinfection machines and in steam sterilisation.

Further advantages of our stericlin® thermal transfer films include:

- Very high resistance to smudge and scratch
- Heat resistance up to 150 °C
- Very good printing quality and resolution
- Excellent sensitivity and receptor multi-compatibility

Please note the right setting for your printer in terms of speed and temperature.

Article No.	Description	Pack (pcs.)
3FSGZ815460	Thermal transfer film APX® FH+, outside coated, 80 mm/74 m, core: 110 mm x 12,7 mm Ø	10
3FSGZ815462	Thermal transfer film APX® FH+, outside coated, 80 mm/300 m, core: 80 mm x 25,4 mm Ø	5
3FSGZ815472	Thermal transfer film APX® FH+, outside coated, 110 mm/300 m, core: 110 mm x 25,4 mm Ø	5
3FSGZ815480	Thermal transfer film AXR® 8, outside coated 60 mm/74 m, core: 110 mm x 12,7 mm Ø	5
3FSGZ815482	Thermal transfer film AXR® 8, outside coated 60 mm/300 m, core: 60 mm x 25,4 mm Ø	1
3FSGZ815484	Thermal transfer film AXR® 8, outside coated 83 mm/74 m, core: 110 mm x 12,7 mm Ø	1

EVERYTHING FOR THE CSSD

Mesh covers 1/2 - PAGE 128

Our stericlin® silicone mesh covers provide secure fixation of instruments and accessories during reprocessing. (Gitterabdeckung 1/1 - 3FEDS842406)

Reusable plastic bowls 150ml - PAGE 13

Reusable plastic bowls offer a variety of uses due to the available colours and sizes.

Holders - PAGE 28

By maximising the area cleaned, the stericlin® holder is an effective aid for successful reprocessing.

Mesh mats 1/2 - PAGE 129

Our stericlin® silicone mesh mats combine protection against slipping with durability. We offer you the right mat size for baskets with perforated side walls and for wire mesh baskets in sizes 1/2 and 1/1.

Kögel wire mesh trays - PAGE 136

We offer sieve baskets with wire mesh or perforated plates in all standard sizes for reprocessing and storage.

Silicone plugs - PAGE 74

Available in different colors for variable attachment of accessories to mesh trays.

Plastic instrument basket tags - PAGE 123

Made of glass fiber reinforced polyamide plastic, they combine the flexibility and durability of a plastic sign with improved adhesion of information media to the sign.

Corner reinforcement - PAGE 75

Prevents damage to the sterile barrier system caused by sharp edges or feet of heavy trays.

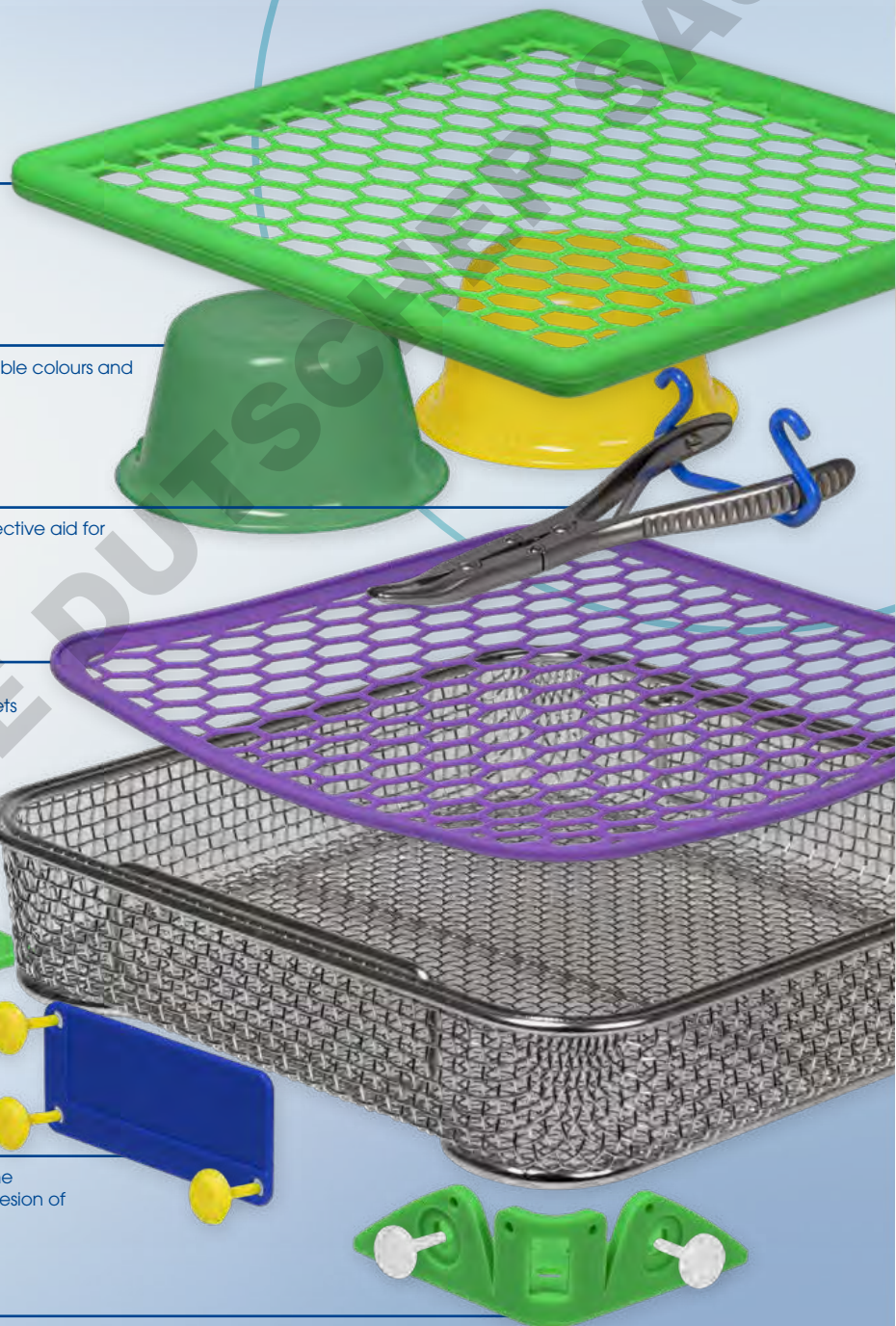



Sterile goods logistics



For safe transportation and storage of your medical devices

Our more than 40 years of expertise in the development and production of indicator systems, sterile barrier systems and sterilisation accessories, led us to support you with a comprehensive high quality range for transportation and storage of your medical devices.

- Transport box and accessories
- Silicone mats
- Instrument basket mesh covers made of silicone
- Instrument basket tags
- Instrument baskets and accessories



Stericlin® transport box

Liquid-tight single-use package for disposal – for transport from the OR to the CSSD

The Stericlin® transport box is the ideal solution for more hygiene and safety in the disposal and transport of contaminated instruments from the OR for preparation in the CSSD.

An easy to handle single-use package - the economic alternative to metal or plastic containers. By using the Stericlin® transport, box handling costs are significantly lowered and additional capacities created in the container washer or washer-disinfector - thus saving on energy, water and cleaning chemicals.

Article No.	Description	Size in mm	Pack (pcs.)
3FSZB855108	Transport box, bottom, size M (for ½ DIN tray 24 × 25 cm)	284 × 280 × 102	50
3FSZB855128	Transport box, lid, size M	300 × 290 × 92	50
3FSZB855110	Transport box, bottom, size L (for DIN tray 48 × 25 cm)	531 × 280 × 102	50
3FSZB855130	Transport box, lid, size L	547 × 290 × 92	50
3FSZB855112	Transport box, bottom, size XL (for DIN tray 54 × 25 cm or loaner trays)	576 × 280 × 139	50
3FSZB855132	Transport box, lid, size XL	592 × 290 × 129	50
3FSZB855114	Transport box, bottom, size XXL	706 × 415 × 112	50
3FSZB855134	Transport box, lid, size XXL	722 × 425 × 102	50
3FSZB855118	Transport box, bottom, „ROBOT“ (for DaVinci instruments „XI“, „SI“ and optics)	831 × 255 × 117	50
3FSZB855138	Transport box, lid, „ROBOT“ (for DaVinci instruments „XI“, „SI“ and optics)	847 × 265 × 107	50



3FSZB855432



3FSZB855402

3FEDS842835

Transport and disposal tray

For safe transport of used instruments and endoscopes

Disposal tray with optional lid for safe transport and disposal of used instruments and endoscopes in medical facilities. It is WD suitable and resistant to disinfectants but not autoclavable.

The perforated PP plastic tray is used to protect packaged sterile goods during storage and transportation. The perforations improve circulation during sterilization and drying.

Article No.	Description	Size in mm	Pack (pcs.)
3FSZB855402	Transport and disposal tray, suitable for washer-disinfectors, resistant to disinfectants, not autoclavable	590 x 295 x 150	1
3FSZB855432	Lid for transport and disposal tray, suitable for washer-disinfectors, resistant to disinfectants, not autoclavable	590 x 295 x 30	1
3FEDS842835	PP plastic tray, rectangular, 200ml, colour: blue, perforated, with spacers, individually packed	560 x 300 x 30	20



3FSZB855454



3FSZB855452



3FSZB730150



3FEDS843704



MR Plast Solutions transport solutions

Product solutions for the daily routine in the CSSD

With MR Plast Solutions GmbH as a cooperation partner, we offer completely individual product solutions made of plastic, silicone and stainless steel for everyday CSSD use.

Article No.	Description	Size in mm	Pack (pcs.)
3FSZB855454	MR Plast transport and storage container incl. lid, suitable for TEE probes, colour: blue, material: polypropylene, WD-suitable, resistant to disinfectants, not autoclavable	600 x 400 x 120	1
3FSZB855452	MR Plast transport and storage container incl. lid, suitable for bronchoscopes, colour: grey, material: polypropylene, WD-suitable, resistant to disinfectants, not autoclavable	600 x 400 x 120	1
3FSZB730150	MR Plast reusable packaging bag for surgical instruments, material: silicone, 6 pockets horizontal	270 x 575 x 10	10
3FEDS843704	MR Plast transport trolley sign, printed on 2 sides, with handle opening	250 x 150 x 2	10



Article No.	Description	Size in mm	Pack (pcs.)
3FSZB855450	MR Plast transport trolley with protective cover for TEE / Broncho transport & storage containers, material: stainless steel (V2A), 6 slide-in compartments, corrosion-resistant, 4 stainless steel swivel castors with TPU coating, 2 with parking brake, incl. protective cover made of PVC-coated polyester fabric, waterproof, transparent front with zippers and roll-up fastening	675 x 474 x 1078	1
3FSZB855456	MR Plast transport and storage container base / tray, colour: blue, material: polypropylene, suitable for washer-disinfectors, resistant to disinfectants, not autoclavable	593 x 388 x 193	5
3FSZB855472	Lid for MR Plast transport and storage containers, colour: blue, material: polypropylene, suitable for washer-disinfectors, resistant to disinfectants, not autoclavable	600 x 400 x 23	5
3FSZB855474	Lid for MR Plast transport and storage containers, with embossing: "AEMP", colour: blue, material: polypropylene, suitable for washer-disinfectors, resistant to disinfectants, not autoclavable	600 x 400 x 23	5
3FSZB855492	Replacement handles for transport and storage containers, colour: yellow		10
3FSZB855494	Replacement handles for transport and storage containers, colour: red		10
3FSZB855496	Replacement handles for transport and storage containers, colour: green		10
3FSZB855498	Replacement handles for transport and storage containers, colour: light blue		10



Paper rack

Robust and flexible paper rack for efficient storage and mobility

The mobile paper rack offers an ideal solution for storing and easily accessing sheets of paper and fleece up to a length of 1200 mm.

The robust square tube frame construction (25 x 25 mm) is made of 18/10 stainless steel (material 1.4301) and is burr-free for added safety and durability.

The rack is equipped with four swivel castors (diameter 75 mm), two of which are lockable. These castors are abrasion-resistant, non-staining, anti-static and fitted with thread guards and wall deflectors to ensure maximum maneuverability and protection.

The rack has four frames that provide sufficient space for sheets of paper or fleece.

Article No.	Description	Size in mm
3FEDS850490	Paper rack, mobile, made of 18/10 chromium-nickel steel, material 1.4301	1357 x 545 x 920



Stericlin® plastic instrument basket tags

In different colours to differentiate between departments or priorities

Our stericlin® instrument basket tags made of glass fiber reinforced polyamide combine the flexibility and durability of a plastic tag with improved adhesion of information mediums to the tag. The material is heat resistant up to 134 °C.

We offer different colours to differentiate between departments or priorities.

The instrument basket tags can be fixed with our silicone plugs (page 74) or silicone cable ties (page 92).

Article No.	Size in mm	Colour	Pack (pcs.)
3FEDS843402	90 x 38	blue	100
3FEDS843404	90 x 38	yellow	100
3FEDS843406	90 x 38	gray	100
3FEDS843408	90 x 38	green	100
3FEDS843410	90 x 38	sky blue	100
3FEDS843412	90 x 38	purple	100
3FEDS843414	90 x 38	royal blue	100
3FEDS843416	90 x 38	orange	100
3FEDS843418	90 x 38	pink	100
3FEDS843420	90 x 38	red	100
3FEDS843422	90 x 38	black	100
3FEDS843424	90 x 38	white	100
3FEDS843426	90 x 38	terracotta	100
3FEDS843428	90 x 38	lime	100
3FEDS843430	90 x 38	turquoise	100
3FEDS843432	90 x 38	mustard	100
3FEDS843434	90 x 38	beige	100



Stericlin® clip-on labels made of plastic

In different colours to distinguish between departments or priorities

Our stericlin® clip-on labels made of plastic combine the flexibility and durability of a plastic label with improved adhesion of film labels to the label. At the same time, the clip-on signs are heat-resistant up to 134 °C.

To distinguish departments or priorities, we offer different colours.

Use with P-Touch labels is only recommended to a limited extent.

Article No.	Size in mm	Colour	Pack (pcs.)
3FEDS843602	30 x 30	red	25
3FEDS843604	30 x 30	orange	25
3FEDS843606	30 x 30	light blue	25
3FEDS843608	30 x 30	blue	25
3FEDS843610	30 x 30	yellow	25
3FEDS843612	30 x 30	white	25
3FEDS843614	30 x 30	black	25
3FEDS843616	30 x 30	violet	25
3FEDS843618	30 x 30	green	25
3FEDS843620	30 x 30	light green	25
3FEDS843622	30 x 30	brown	25

Article No.	Size in mm	Colour	Pack (pcs.)
3FEDS843652	75 x 33	red	25
3FEDS843654	75 x 33	orange	25
3FEDS843656	75 x 33	light blue	25
3FEDS843658	75 x 33	blue	25
3FEDS843660	75 x 33	yellow	25
3FEDS843662	75 x 33	white	25
3FEDS843664	75 x 33	black	25
3FEDS843666	75 x 33	violet	25
3FEDS843668	75 x 33	green	25
3FEDS843670	75 x 33	light green	25
3FEDS843672	75 x 33	brown	25



3FEDS843152



3FEDS843170

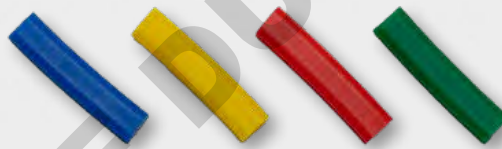

Stainless steel instrument basket tags with colour identification

For labelling, allocation and transmission of information

For the first time, our new stericlin® stainless steel instrument basket tags with colour identification made of silicone combine the material advantages of durable stainless steel with the labelling options of conventional plastic tags. The coloured silicone inserts can be assigned to departments, priorities or affiliations, for example.

Article No.	Size in mm	Colour	Pack (pcs.)
3FEDS843152	90 × 30	blue	10
3FEDS843154	90 × 30	red	10
3FEDS843156	90 × 30	yellow	10
3FEDS843158	90 × 30	green	10
3FEDS843168	90 × 50	blue	10
3FEDS843170	90 × 50	red	10
3FEDS843172	90 × 50	yellow	10
3FEDS843174	90 × 50	green	10



3FEDS843102



3FEDS843108



3FEDS843114

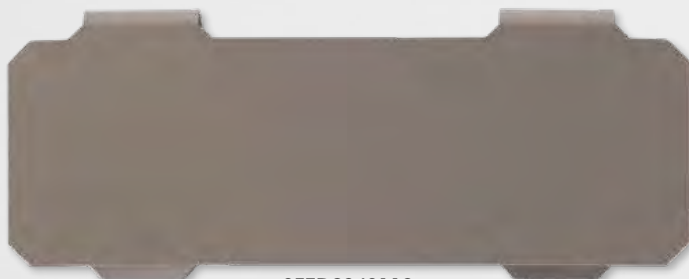

3FEDS843118



3FEDS843122



3FEDS843104



3FEDS843116

Stericlin® stainless steel instrument basket tags

For labelling, classification and displaying information

Stericlin® stainless steel instrument basket tags are indispensable in every processing department for medical devices as they help identify individual instrument baskets, instruments and sets or even transport trolleys. Important information such as department affiliation, contents, barcodes and much more can be applied to the tags by means of labels, laser or etching engraving and P-Touch labels.

We offer Stericlin® stainless steel instrument basket tags in two versions:
Basket tags / Clip tags

The basket tags can be fixed with our silicone plugs (page 74) or silicone cable ties (page 92).

For more information on application and options, contact our sales team or visit us online at www.stericlin.com.



3FEDS843106



3FEDS843110



3FEDS843103



3FEDS843112

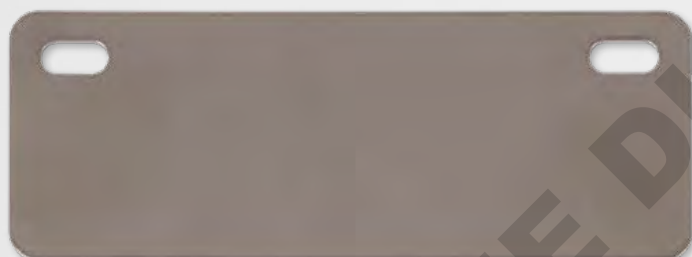

3FEDS843120



3FEDS843124

Article No.	Description	Size in mm	Pack (pcs.)
3FEDS843102	Stainless steel clip tag, material: 1.4310	30 × 30	25
3FEDS843108	Stainless steel clip tag, material: 1.4310	55 × 30	25
3FEDS843114	Stainless steel clip tag, material: 1.4310	70 × 30	25
3FEDS843118	Stainless steel clip tag, material: 1.4310	90 × 30	25
3FEDS843122	Stainless steel clip tag, material: 1.4310	90 × 50	25
3FEDS843104	Stainless steel clip tag, material: 1.4310	42 × 36	25
3FEDS843116	Stainless steel clip tag, material: 1.4310	75 × 35	25
3FEDS843106	Stainless steel clip tags holder for plastic tag inserts, material: 1.4310	50 × 20	25
3FEDS843110	Stainless steel clip tags holder for plastic tag inserts, material: 1.4310	60 × 40	25
3FEDS843103	Stainless steel basket tag, material: 1.4310	40 × 20	50
3FEDS843112	Stainless steel basket tag, material: 1.4404	65 × 24	5
3FEDS843120	Stainless steel basket tag, material: 1.4404	90 × 33	50
3FEDS843124	Stainless steel basket tag, material: 1.4404	90 × 50	50

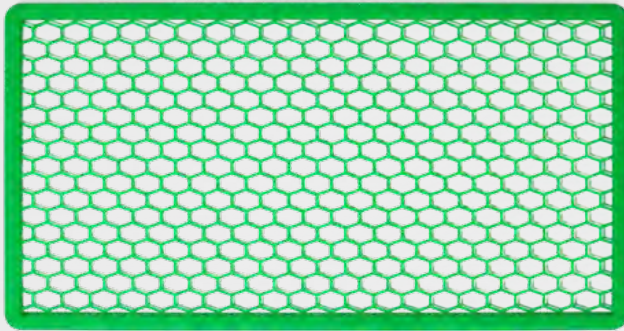

3FEDS842404 / 3FEDS842406

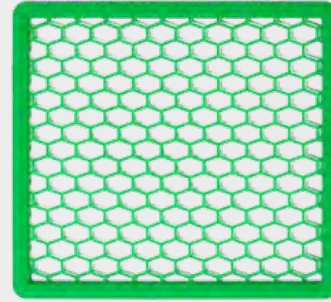

3FEDS842408 / 3FEDS842410

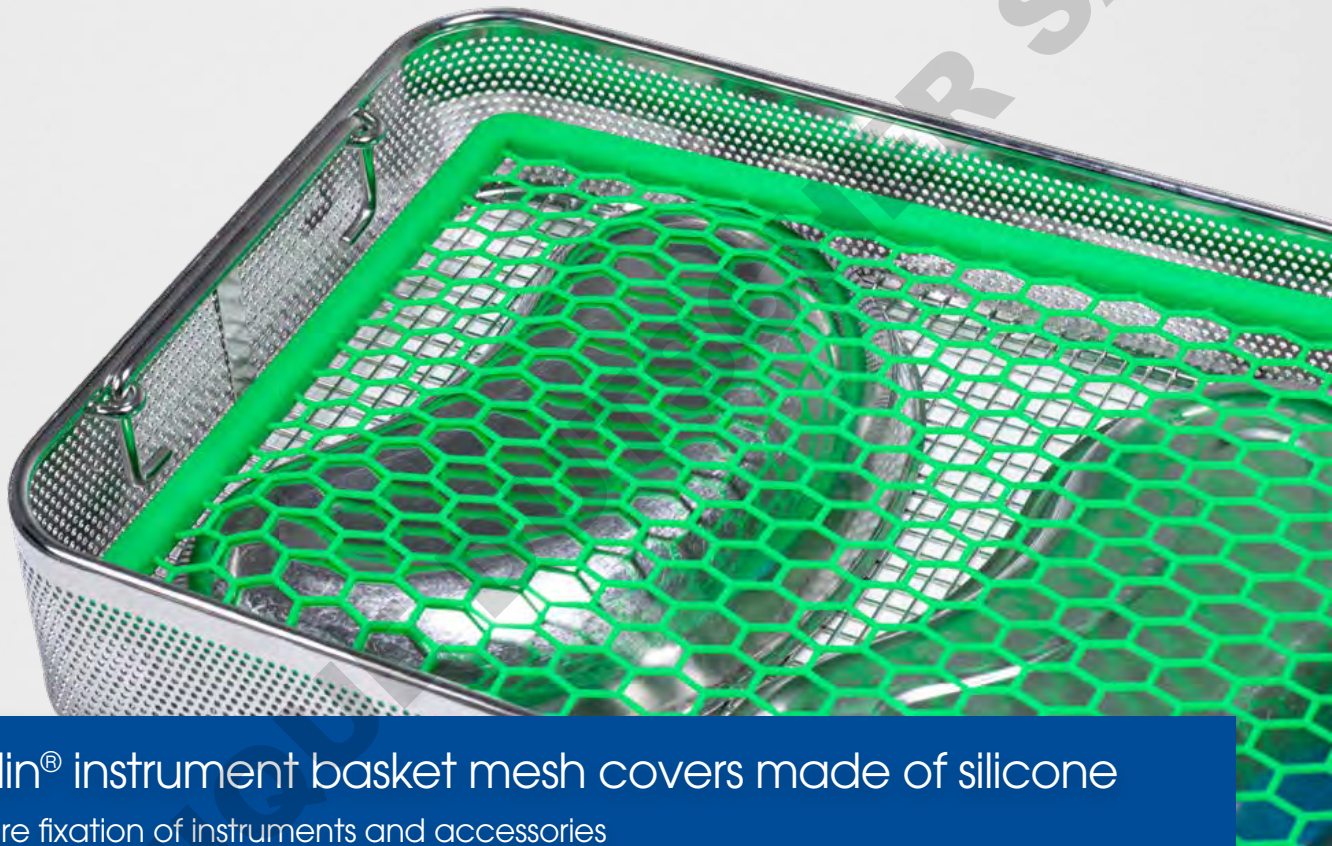

Stericlin® instrument basket mesh covers made of silicone

For secure fixation of instruments and accessories

Our Stericlin® silicone mesh covers provide secure fixation of instruments and accessories during reprocessing.

The improved design of the hexagonal structure prevents accumulation of moisture even more consequently.

The instrument basket covers with internal stainless steel frame offer increased stability due to their heavier weight.

Article No.	Description	Size in mm	Pack (pcs.)
3FEDS842404	Silicone mesh basket cover, flexible, with hexagonal structure for improved drying, heat resistant: up to 200 °C	440 x 230	1
3FEDS842406	Silicone mesh basket cover, rigid, with internal stainless steel frame and hexagonal structure for improved drying, heat resistant: up to 200 °C	440 x 230	1
3FEDS842408	Silicone mesh basket cover, flexible, with hexagonal structure for improved drying, heat resistant: up to 200 °C	230 x 210	1
3FEDS842410	Silicone mesh basket cover, rigid, with internal stainless steel frame and hexagonal structure for improved drying, heat resistant: up to 200 °C	230 x 210	1



3FEDS842402

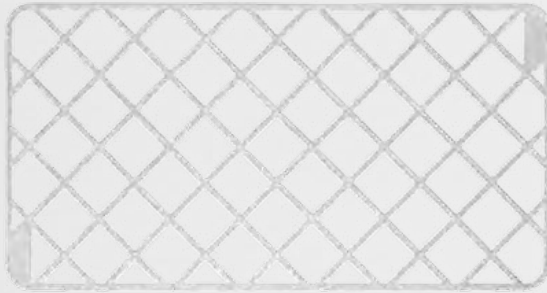

3FEDS842418

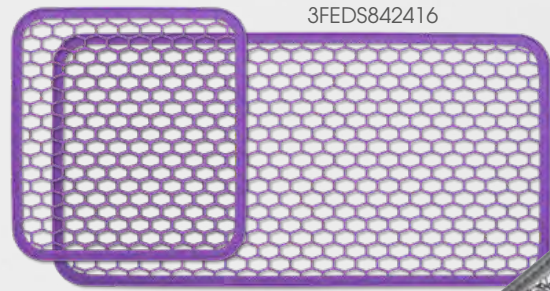

3FEDS842416

3FEDS842412

3FEDS842414

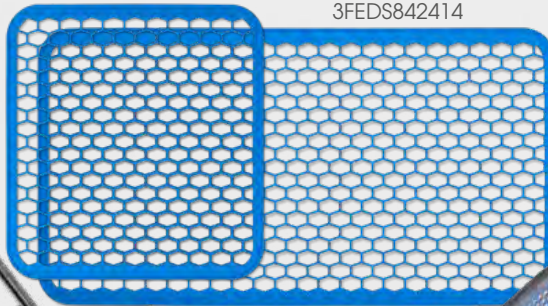

Stericlin® silicone mesh mats

Flexible inserts to prevent slipping

Our stericlin® silicone mesh mats combine protection against slipping with durability.

The mats are washer-disinfector compatible and due to their improved structure they prevent the accumulation of moisture even more consequently.

We offer you the right mesh mat size for baskets with perforated sides as well as wire mesh baskets.

Article No.	Description	Size in mm	Pack (pcs.)
3FEDS842412	Silicone mat for perforated plate baskets 1/2, with hexagonal structure for improved drying, heat resistant: up to 200 °C	238 x 248	1
3FEDS842414	Silicone mat for perforated plate baskets 1/1, with hexagonal structure for improved drying, heat resistant: up to 200 °C	480 x 250	1
3FEDS842418	Silicone mat for wire mesh baskets 1/2, with hexagonal structure for improved drying, heat resistant: up to 200 °C	215 x 229	1
3FEDS842416	Silicone mat for wire mesh baskets 1/1, with hexagonal structure for improved drying, heat resistant: up to 200 °C	460 x 229	1
3FEDS842402	Silicone mat for system / transport baskets 1/1, heat resistant: up to 200 °C	540 x 280 x 3	1

3FEDS850301



3FEDS850302



3FEDS850303
3FEDS850304
3FEDS850305



3FEDS850309
3FEDS850310
3FEDS850311



3FEDS850315
3FEDS850316
3FEDS850317



3FEDS850326
3FEDS850327
3FEDS850328
3FEDS850329



3FEDS850341
3FEDS850342

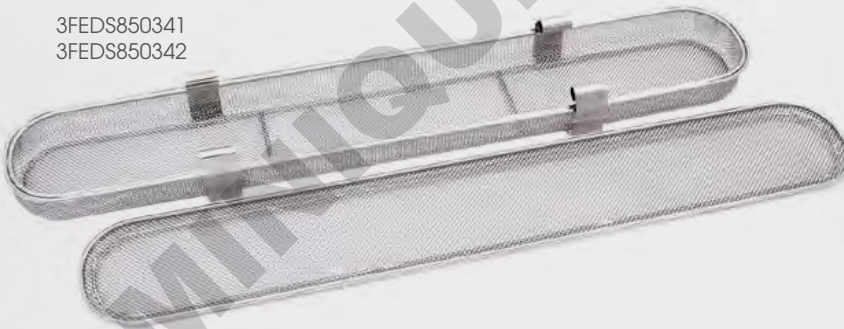

Kögel system small parts tray sets

For optimized organization of sterile goods

Kögel small parts tray sets with patented double frame enable optimized organization of sterile goods. The flexible, configurable system offers product-specific storage solutions, as well as optimized individual holding of a wide variety of instruments.



3FEDS850349
3FEDS850350
3FEDS850351



3FEDS850356



Article No.	Description	Dimensions L x W x H (mm)	Mesh size in mm
3FEDS850301	1/32	63 x 63 x 23,5	1 x 1 x 0,5
3FEDS850302	for drills	135 x 37,5 x 23,4	1 x 1 x 0,5
3FEDS850303	1/16	121 x 73 x 35	1 x 1 x 0,5
3FEDS850304	1/16	121 x 73 x 35	2,5 x 2,5 x 0,7
3FEDS850305	1/16	121 x 73 x 53	2,5 x 2,5 x 0,7
3FEDS850309	1/8	121 x 121 x 35	1 x 1 x 0,5
3FEDS850310	1/8	121 x 121 x 35	2,5 x 2,5 x 0,7
3FEDS850311	1/8	121 x 121 x 53	2,5 x 2,5 x 0,7
3FEDS850315	1/6	236 x 73,5 x 35	1 x 1 x 0,5
3FEDS850316	1/6	236 x 73,5 x 53	2,5 x 2,5 x 0,7
3FEDS850317	1/6 XL	296 x 73,5 x 53	2,5 x 2,5 x 0,7
3FEDS850326	1/4	236 x 122 x 35	1 x 1 x 0,5
3FEDS850327	1/4	236 x 122 x 35	2,5 x 2,5 x 0,7

Article No.	Description	Dimensions L x W x H (mm)	Mesh size in mm
3FEDS850328	1/4	236 x 122 x 53	2,5 x 2,5 x 0,7
3FEDS850329	1/4-296	296 x 122 x 53	2,5 x 2,5 x 0,7
3FEDS850330	1/4-370	370 x 122 x 53	2,5 x 2,5 x 0,7
3FEDS850331	1/4-480	480 x 122 x 53	2,5 x 2,5 x 0,7
3FEDS850332	1/4-560	560 x 122 x 53	2,5 x 2,5 x 0,7
3FEDS850333	1/4-731	731 x 122 x 53	5 x 5 x 1
3FEDS850341	1/3 L	466 x 73,5 x 35	1 x 1 x 0,5
3FEDS850342	1/3 L	466 x 73,5 x 53	2,5 x 2,5 x 0,7
3FEDS850349	1/2	236 x 236 x 35	1 x 1 x 0,5
3FEDS850350	1/2	236 x 236 x 35	2,5 x 2,5 x 0,7
3FEDS850351	1/2	236 x 236 x 53	2,5 x 2,5 x 0,7
3FEDS850356	1/1	482 x 250 x 58	2,5 x 2,5 x 0,7



Stainless steel trays for small parts with clip closure

For optimized organization of sterile goods

Trays for small parts are used to prepare various small parts (screws, implants, etc.) in the operating theatre and are the basic support for reprocessing in the sterilisation unit. They also facilitate instrument organisation in the wire basket and in the CSSD. Our mesh baskets for small parts provide an economical alternative to comparable products on the market and are designed for efficiency and quality.

A wide range of dimensions assures the necessary flexibility and can also be extended with customised variants for larger purchase quantities. We offer fine meshes of 1,6 x 1,6 mm as standard as well as ultra-fine meshes of 0,5 x 0,5 mm for special applications, such as the preparation of K-wires, fine probes and other small parts.

Article No.	Description	Dimensions L x W x H (mm)	Mesh size in mm
3FEDS842102	fine	40 x 40 x 20	1,6 x 1,6 x 0,7
3FEDS842104	fine	40 x 40 x 30	1,6 x 1,6 x 0,7
3FEDS842106	fine	70 x 70 x 30	1,6 x 1,6 x 0,7
3FEDS842108	fine	80 x 40 x 20	1,6 x 1,6 x 0,7
3FEDS842110	fine	80 x 40 x 30	1,6 x 1,6 x 0,7
3FEDS842112	fine	80 x 80 x 34	1,6 x 1,6 x 0,7
3FEDS842114	fine	80 x 80 x 40	1,6 x 1,6 x 0,7
3FEDS842116	fine	80 x 80 x 50	1,6 x 1,6 x 0,7
3FEDS842118	fine	90 x 90 x 50	1,6 x 1,6 x 0,7
3FEDS842120	fine	100 x 100 x 50	1,6 x 1,6 x 0,7
3FEDS842122	fine	105 x 70 x 25	1,6 x 1,6 x 0,7
3FEDS842124	fine	150 x 50 x 35	1,6 x 1,6 x 0,7
3FEDS842126	fine	190 x 85 x 100	1,6 x 1,6 x 0,7

Article No.	Description	Dimensions L x W x H (mm)	Mesh size in mm
3FEDS842128	fine	200 x 100 x 35	1,6 x 1,6 x 0,7
3FEDS842130	fine	220 x 140 x 50	1,6 x 1,6 x 0,7
3FEDS842132	fine	235 x 155 x 40	1,6 x 1,6 x 0,7
3FEDS842134	fine	240 x 90 x 40	1,6 x 1,6 x 0,7
3FEDS842136	fine	240 x 120 x 35	1,6 x 1,6 x 0,7
3FEDS842138	fine	275 x 175 x 35	1,6 x 1,6 x 0,7
3FEDS842140	fine	275 x 200 x 35	1,6 x 1,6 x 0,7
3FEDS842152	ultrafine	80 x 40 x 30	0,5 x 0,5 x 0,3
3FEDS842154	ultrafine	80 x 80 x 34	0,5 x 0,5 x 0,3
3FEDS842156	ultrafine	100 x 100 x 50	0,5 x 0,5 x 0,3
3FEDS842158	ultrafine	180 x 130 x 30	0,5 x 0,5 x 0,3
3FEDS842160	ultrafine	230 x 100 x 60	0,5 x 0,5 x 0,3
3FEDS842162	ultrafine	240 x 120 x 60	0,5 x 0,5 x 0,3



Double wire baskets

For optimized organization of sterile goods

The system baskets feature a double frame design, ensuring enhanced durability and stability. They enable protected storage and optimal organization of sterile goods, focusing on handling safety and processing quality while maximizing cost-effectiveness. Additionally, their stackable nature facilitates efficient use of space.

Article No.	Description	Dimensions in mm
3FEDS842870	1/1, 138, with handle opening	600 x 300 x 138
3FEDS842871	1/2, 138, with handle opening	300 x 300 x 138
3FEDS842872	1/1, 150, with handle opening	600 x 300 x 150



System baskets



Wire containers

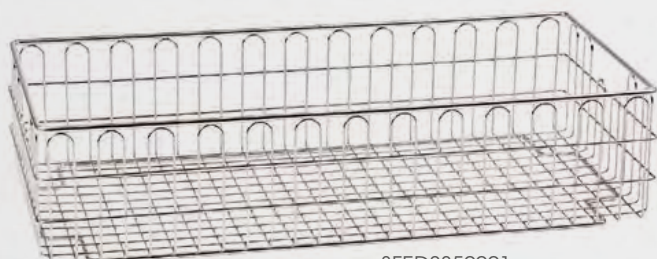

3FEDS850001



3FEDS850003



Kögel system baskets

For optimized organization of sterile goods

Kögel system baskets enable protected storage and optimum organization of sterile goods. The focus here is on handling safety and processing quality, with the highest degree of cost-effectiveness. The extremely extensive product range, as well as customer-specific solutions, enable exact adaptation to medical and logistical requirements.

System baskets		
Article No.	Description	Dimensions in mm
3FEDS850126	1/2, 96, with handle opening	300 x 298 x 96
3FEDS850127	1/2, 150, with handle opening	300 x 298 x 148
3FEDS850128	1/2, 204, with handle opening	300 x 298 x 204
3FEDS850129	1/2, 250, with handle opening	300 x 298 x 250
3FEDS850130	1/1, 96, with handle opening	580 x 298 x 96
3FEDS850131	1/1, 128, with handle opening	580 x 298 x 128
3FEDS850132	1/1, 148, with recess on front side	580 x 298 x 148
3FEDS850133	1/1, 150, with handle opening	580 x 298 x 148
3FEDS850134	1/1, 204, with handle opening	580 x 298 x 204
3FEDS850135	1/1, 250, with handle opening	580 x 298 x 249
3FEDS850136	1/1 ISO, 150, with handle opening	580 x 378 x 148

Wire containers		
Article No.	Description	Dimensions in mm
3FEDS850014	Size 3	327 x 197 x 200
3FEDS850015	Size 4	230 x 150 x 125
3FEDS850016	Size 3, attachable in equipment rails	388 x 197 x 200
3FEDS850017	Size 4, attachable in equipment rails	290 x 145 x 123
3FEDS850001	Sterile-goods basket 1/2 DIN-StE, with handle opening	575 x 278 x 132
3FEDS850003	Sterile-goods basket 1 DIN-StE, with handle opening	575 x 278 x 260



Set
incl. system clips



Kögel system trays

For optimized organization of sterile goods

The selection of Kögel System trays offers exact adaptation to medical and logistical requirements. At the same time, the modular system enables extremely flexible organization of the sterile goods. The patented double frame is a prerequisite for handling safety and at the same time reduces repair costs.

Trays			
Article No.	Description	Dimensions in mm	Mesh size in mm
3FEDS850107	Tray, 1/2 SL 50	240 x 250 x 50	4 x 4 x 1
3FEDS850108	Tray, 1/2 SL 70	240 x 250 x 70	5 x 5 x 1
3FEDS850109	Tray, 1/1 SL 50	482 x 250 x 50	4 x 4 x 1
3FEDS850110	Tray, 1/1 SL 70	482 x 250 x 70	5 x 5 x 1
3FEDS850101	Set 1/2 SL 50/50, incl. system clips	240 x 250 x 100	4 x 4 x 1
3FEDS850102	Set 1/2 SL 50/70, incl. system clips	240 x 250 x 120	4 x 4 / 5 x 5
3FEDS850103	Set 1/2 SL 70/70, incl. system clips	240 x 250 x 140	5 x 5 x 1
3FEDS850104	Set 1/1 SL 50/50, incl. system clips	482 x 250 x 100	4 x 4 x 1
3FEDS850105	Set 1/1 SL 50/70, incl. system clips	482 x 250 x 120	4 x 4 / 5 x 5
3FEDS850106	Set 1/1 SL 70/70, incl. system clips	482 x 250 x 140	5 x 5 x 1

Lids			
Article No.	Description	Dimensions in mm	Mesh size in mm
3FEDS850112	Lid, 1/2 SL 50, incl. removable clips	242 x 241 x 9	4 x 4 x 1
3FEDS850114	Lid, 1/2 SL 70, incl. removable clips	242 x 241 x 9	4 x 4 x 1
3FEDS850116	Lid, 1/1 SL 50, incl. removable clips	482 x 241 x 9	4 x 4 x 1
3FEDS850118	Lid, 1/1 SL 70, incl. removable clips	482 x 241 x 9	4 x 4 x 1
3FEDS850111	Lid, 1/2 SL 50, incl. fixed clips	242 x 241 x 9	4 x 4 x 1
3FEDS850113	Lid, 1/2 SL 70, incl. fixed clips	242 x 241 x 9	4 x 4 x 1
3FEDS850115	Lid, 1/1 SL 50, incl. fixed clips	482 x 241 x 9	4 x 4 x 1
3FEDS850117	Lid, 1/1 SL 70, incl. fixed clips	482 x 241 x 9	4 x 4 x 1



3FEDS850204

3FEDS850233



Kögel wire mesh trays

For optimized organization of sterile goods

Kögel wire mesh trays are manufactured with handling safety and reprocessing efficiency in mind. The extremely extensive product range, as well as customer-specific solutions, make exact adaptation to medical and logistical requirements possible.

The patented double frame drastically reduces repair costs and protects staff as well as sterile goods, as no sharp / pointed wires can stick out.

All wire mesh baskets are made of high-quality stainless steel (material 1.4301), electrolytically polished, processed without burrs and are stackable due to the base frame. A modular system of accessories (e.g. lids, silicone holders, etc.) allows variable use of the screen baskets. For further information on application and options, please contact our sales team or visit our website at www.sterclin.com.



3FEDS850227

3FEDS850235

Article No.	Size	Dimensions in mm	Mesh size in mm
3FEDS850201	265	265 x 120 x 45	4 x 4 x 1
3FEDS850202	265	264 x 175 x 38	4 x 4 x 1
3FEDS850203	1/2-30	240 x 250 x 30	4 x 4 x 1
3FEDS850204	1/2-50	240 x 250 x 50	4 x 4 x 1
3FEDS850205	1/2-70	240 x 250 x 70	5 x 5 x 1
3FEDS850206	1/2-100	240 x 250 x 100	5 x 5 x 1
3FEDS850207	3/4-50	362 x 250 x 50	4 x 4 x 1
3FEDS850208	3/4-70	362 x 250 x 70	5 x 5 x 1
3FEDS850209	3/4 L-30	404 x 250 x 30	4 x 4 x 1
3FEDS850210	3/4 L-50	404 x 250 x 50	4 x 4 x 1
3FEDS850211	3/4 L-70	404 x 250 x 70	5 x 5 x 1
3FEDS850212	3/4 L-100	404 x 250 x 100	5 x 5 x 1
3FEDS850213	1/1-30	482 x 250 x 30	4 x 4 x 1
3FEDS850214	1/1-50	482 x 250 x 50	4 x 4 x 1
3FEDS850215	1/1-70	482 x 250 x 70	5 x 5 x 1
3FEDS850216	1/1-100	482 x 250 x 100	5 x 5 x 1
3FEDS850217	ISO	482 x 340 x 50	4 x 4 x 1
3FEDS850218	530-30	530 x 250 x 30	4 x 4 x 1
3FEDS850219	530-50	530 x 250 x 50	4 x 4 x 1
3FEDS850220	530-70	530 x 250 x 70	5 x 5 x 1

Article No.	Size	Dimensions in mm	Mesh size in mm
3FEDS850221	530-100	530 x 250 x 100	5 x 5 x 1
3FEDS850222	XL 560/50	560 x 250 x 50	4 x 4 x 1
3FEDS850223	XL 560/70	560 x 250 x 70	5 x 5 x 1
3FEDS850224	1/2-50	240 x 250 x 50	4 x 4 x 1
3FEDS850225	1/2-70	240 x 250 x 70	5 x 5 x 1
3FEDS850226	1/1-50	482 x 250 x 50	4 x 4 x 1
3FEDS850227	1/1-70	482 x 250 x 70	5 x 5 x 1

Lids			
Article No.	Size	Dimensions in mm	Mesh size in mm
3FEDS850230	turn-lock fastener	265 x 120 x 16,8	6 x 6 x 1
3FEDS850231	turn-lock fastener	265 x 175 x 16,8	6 x 6 x 1
3FEDS850232	1/2, 4 centering eyes	240 x 250 x 8	4 x 4 x 1
3FEDS850233	1/2, turn-lock fastener	240 x 250 x 14,8	6 x 6 x 1
3FEDS850234	3/4, turn-lock fastener	404 x 250 x 14,8	6 x 6 x 1
3FEDS850235	1/1, 4 centering eyes	480 x 250 x 8	4 x 4 x 1
3FEDS850236	1/1, turn-lock fastener	482 x 250 x 14,8	6 x 6 x 1
3FEDS850237	530, turn-lock fastener	530 x 250 x 14,8	6 x 6 x 1



Tray with drop-type handles

Lid with turn-lock fastener



Kögel perforated plate trays

For optimized organization of sterile goods

The Kögel trays made of perforated plates offer an ideal solution when soft packaging is used. The perforations in the side walls protect both the valuable sterile goods and the soft packaging from damage, and the overlap-free weld seams reduce the risk of contamination.

A modular system of accessories (e.g. lids, silicone holders, etc.) allows variable use of the sieve baskets.

All perforated plate baskets are made of high-quality stainless steel (material 1.4301), electrolytically polished, processed burr-free and are stackable due to the base frame.



Tray with drop and retractable handles

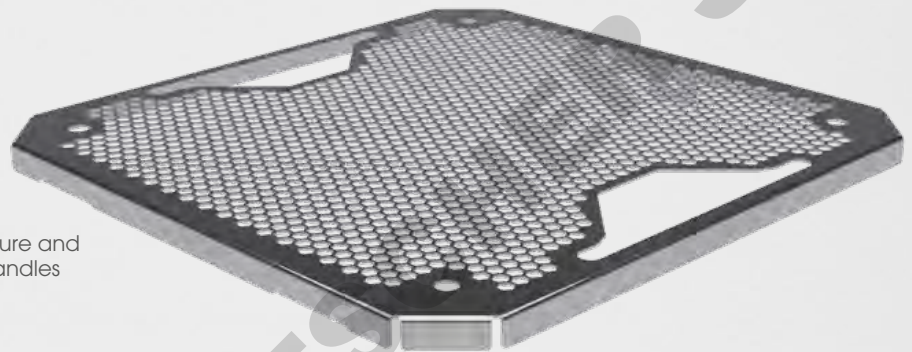

Lid with clip closure and opening for handles

Article No.	Description	Size	Dimensions in mm	Mesh size in mm
3FEDS850249	Tray, drop-type handles	1/2-60	240 x 250 x 65	Bottom: 4 x 4, walls: 2 x 2
3FEDS850250	Tray, drop-type handles	1/1-60	480 x 250 x 65	Bottom: 4 x 4, walls: 2 x 2
3FEDS850251	Tray, drop-type handles	1/1-100	480 x 250 x 105	Bottom: 4 x 4, walls: 2 x 2
3FEDS850252	Lid, turn-lock fastener	1/1	478 x 247 x 16,5	6 x 6
3FEDS850253	Lid, turn-lock fastener	1/2	238 x 247 x 16,5	6 x 6
3FEDS850254	Tray, drop and retractable handles	1/2-30	243 x 253 x 31	Bottom: 5 x 5, walls: 3 x 3
3FEDS850255	Tray, drop and retractable handles	1/2-50	243 x 253 x 47	Bottom: 5 x 5, walls: 3 x 3
3FEDS850256	Tray, drop and retractable handles	1/2-70	243 x 253 x 67	Bottom: 5 x 5, walls: 3 x 3
3FEDS850257	Tray, drop and retractable handles	1/2-100	243 x 253 x 95	Bottom: 5 x 5, walls: 3 x 3
3FEDS850258	Tray, drop and retractable handles	3/4-30	405 x 253 x 31	Bottom: 5 x 5, walls: 3 x 3
3FEDS850259	Tray, drop and retractable handles	3/4-50	405 x 253 x 47	Bottom: 5 x 5, walls: 3 x 3
3FEDS850260	Tray, drop and retractable handles	3/4-70	405 x 253 x 67	Bottom: 5 x 5, walls: 3 x 3
3FEDS850261	Tray, drop and retractable handles	3/4-100	405 x 253 x 95	Bottom: 5 x 5, walls: 3 x 3
3FEDS850262	Tray, drop and retractable handles	1/1-30	480 x 253 x 31	Bottom: 5 x 5, walls: 3 x 3
3FEDS850263	Tray, drop and retractable handles	1/1-50	480 x 253 x 47	Bottom: 5 x 5, walls: 3 x 3
3FEDS850264	Tray, drop and retractable handles	1/1-70	480 x 253 x 67	Bottom: 5 x 5, walls: 3 x 3
3FEDS850265	Tray, drop and retractable handles	1/1-100	480 x 253 x 95	Bottom: 5 x 5, walls: 3 x 3
3FEDS850266	Tray, drop and retractable handles	540-30	540 x 253 x 31	Bottom: 5 x 5, walls: 3 x 3
3FEDS850267	Tray, drop and retractable handles	540-50	540 x 253 x 47	Bottom: 5 x 5, walls: 3 x 3
3FEDS850268	Tray, drop and retractable handles	540-70	540 x 253 x 67	Bottom: 5 x 5, walls: 3 x 3
3FEDS850269	Lid with clip closure and opening for handles	1/2	244 x 254 x 15	5 x 5
3FEDS850270	Lid with clip closure and opening for handles	3/4	406 x 254 x 15	5 x 5
3FEDS850271	Lid with clip closure and opening for handles	1/1	481 x 254 x 15	5 x 5
3FEDS850272	Lid with clip closure and opening for handles	540	541 x 254 x 15	5 x 5



3FEDS850416



3FEDS850411



3FEDS850423



3FEDS850424



3FEDS850425



3FEDS850426



3FEDS850427



3FEDS850428



3FEDS850429



3FEDS850430



3FEDS850431



3FEDS850432



3FEDS850458

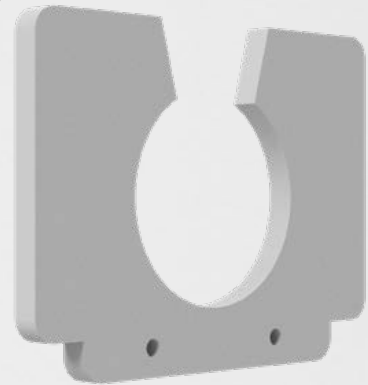

3FEDS850459



Silicone mountings with different diameters

For secure transport of instruments and endoscopes

Silicone mountings used for individual fixation of rigid optics and instruments. This protects the endoscope from slipping and damage during transport and sterilization.

Article No.	Description	Size in mm
3FEDS850411	Holder for the fixation of silicone mountings, screwable, 2 pins	55 x 18,5 x Ø 6
3FEDS850412	Holder for the fixation of silicone mountings, screwable, 3 pins	90 x 18,5 x Ø 6
3FEDS850413	Holder for the fixation of silicone mountings, screwable, 3 pins	110 x 18,5 x Ø 6
3FEDS850414	Holder for the fixation of silicone mountings, screwable, 3 pins	140 x 18,5 x Ø 6
3FEDS850415	Holder for the fixation of silicone mountings, screwable, 4 pins	200 x 18,5 x Ø 6
3FEDS850416	Holder for the fixation of silicone mountings, clipable, 2 pins	61,5 x 38 x Ø 6
3FEDS850417	Holder for the fixation of silicone mountings, clipable, 3 pins	109 x 20 x Ø 6
3FEDS850418	Holder for the fixation of silicone mountings, clipable, 3 pins	152 x 38 x Ø 6
3FEDS850419	Holder for the fixation of silicone mountings, clipable, 4 pins	224 x 38 x Ø 6
3FEDS850420	Holder for the fixation of silicone mountings, clipable, 4 pins	232 x 38 x Ø 6



3FEDS850433



3FEDS850434



3FEDS850435



3FEDS850436



3FEDS850437



3FEDS850438



3FEDS850439



3FEDS850440



3FEDS850441

Article No.	Description	Size in mm
3FEDS850423	Silicone mounting, open, for 1 instrument	45 x 33 x 5 x Ø 5
3FEDS850424	Silicone mounting, closed, for 1 instrument	45 x 33 x 5 x Ø 6
3FEDS850425	Silicone mounting, open, for 1 instrument	45 x 33 x 5 x Ø 8
3FEDS850426	Silicone mounting, open, for 1 instrument	45 x 33 x 5 x Ø 10
3FEDS850427	Silicone mounting, closed, for 1 instrument	45 x 33 x 5 x Ø 11
3FEDS850428	Silicone mounting, open, for 1 instrument	45 x 33 x 5 x Ø 12
3FEDS850429	Silicone mounting, open, for 1 instrument	45 x 33 x 5 x Ø 14
3FEDS850430	Silicone mounting, open, for 1 instrument	45 x 33 x 5 x Ø 18
3FEDS850431	Silicone mounting, open, for 1 instrument	45 x 33 x 5 x Ø 20
3FEDS850432	Silicone mounting, slotted, for 7 instruments	45 x 25 x 5
3FEDS850458	Silicone mounting, open, for 1 instrument	50 x 80 x 5 Ø 35
3FEDS850459	Silicone mounting, open, for 1 instrument	50 x 60 x 5 Ø 23
3FEDS850433	Silicone mounting, slotted, for 23 instruments	88 x 25 x 5
3FEDS850434	Silicone mounting, fir-tree, for 7 instruments	92 x 25 x 5
3FEDS850435	Silicone mounting, fir-tree, for 6 instruments, suitable only for screwable holder 3FEDS850412	118 x 25 x 5
3FEDS850436	Silicone mounting, fir-tree, for 11 instruments	206 x 25 x 5
3FEDS850437	Silicone mounting, fir-tree, for 18 instruments	206 x 25 x 5
3FEDS850438	Silicone mounting, fir-tree, for 12 instruments	228 x 25 x 5
3FEDS850439	Silicone mounting, slotted, for 37 instruments	230 x 25 x 5
3FEDS850440	Silicone mounting varia, without openings, for cutting-to-size individually, suitable only for screwable holder 3FEDS850412	90 x 25 x 5
3FEDS850441	Silicone blank holder for mounting to the lid, suitable only for screwable holder 3FEDS850412	88 x 22 x 5



3FEDS842202



3FEDS842204



3FEDS842206

Special trays made of stainless steel with silicone holders

For optimized organization of ophthalmology and dental instruments

Ophthalmology trays are used for the safe storage of the finest micro instruments. The instruments are securely fixed during the entire reprocessing cycle as well as during transport. The trays are available in 3 different sizes and can be an economical alternative to cost-intensive custom-made products.

With different sizes and colour coding, dental trays for hand instruments facilitate the organisation of instrument sets, tailored to your needs. The design of the trays ensures that the instruments are very easy to rinse and dry. This ensures efficient reprocessing.



3FEDS842252
3FEDS842258



3FEDS842254
3FEDS842256

Article No.	Description	Dimensions L x W x H (mm)
3FEDS842202	Ophthalmology tray (micro), with silicone holders / strips on base and lid, side walls are made of perforated sheet metal	240 x 250 x 40
3FEDS842204	Ophthalmology tray (micro), with silicone holders / strips on base and lid, side walls are made of perforated sheet metal	340 x 250 x 40
3FEDS842206	Ophthalmology tray (micro), with silicone holders / strips on base and lid, side walls are made of perforated sheet metal	440 x 250 x 40
3FEDS842252	Dental instrument tray, with twist lock and spring holder, side walls are made of perforated sheet metal	220 x 125 x 40
3FEDS842258	Dental instrument tray, with twist lock and spring holder, side walls are made of perforated sheet metal	250 x 220 x 40
3FEDS842254	Dental tray (fine), with tension lock, with silicone holders on bottom and lid	235 x 155 x 40
3FEDS842256	Dental tray (fine), with tension lock, with silicone holders on bottom and lid	240 x 90 x 40

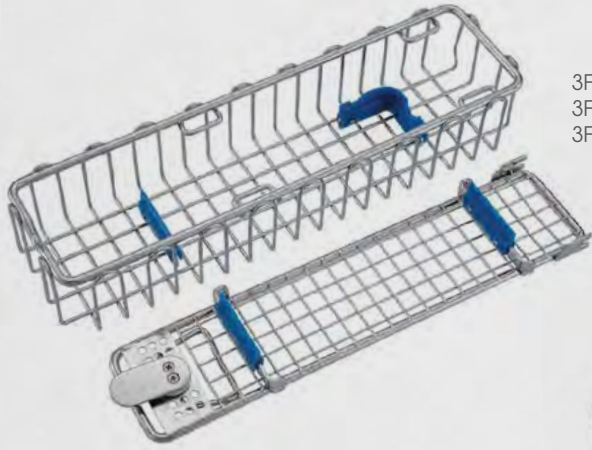

3FEDS842222
3FEDS842224
3FEDS842226

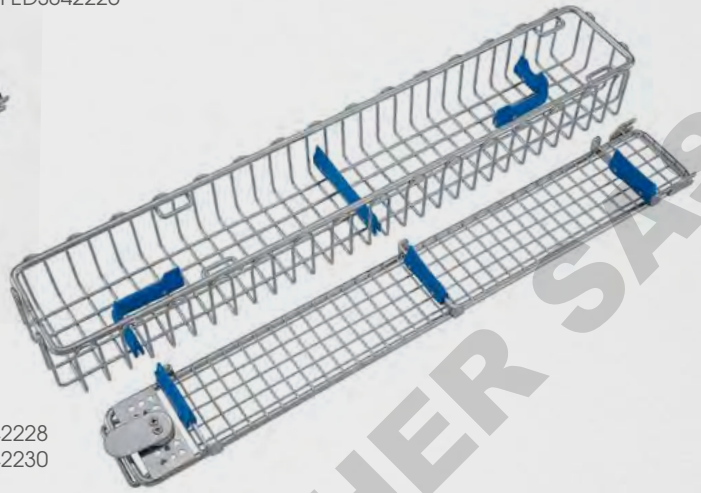

3FEDS842228
3FEDS842230

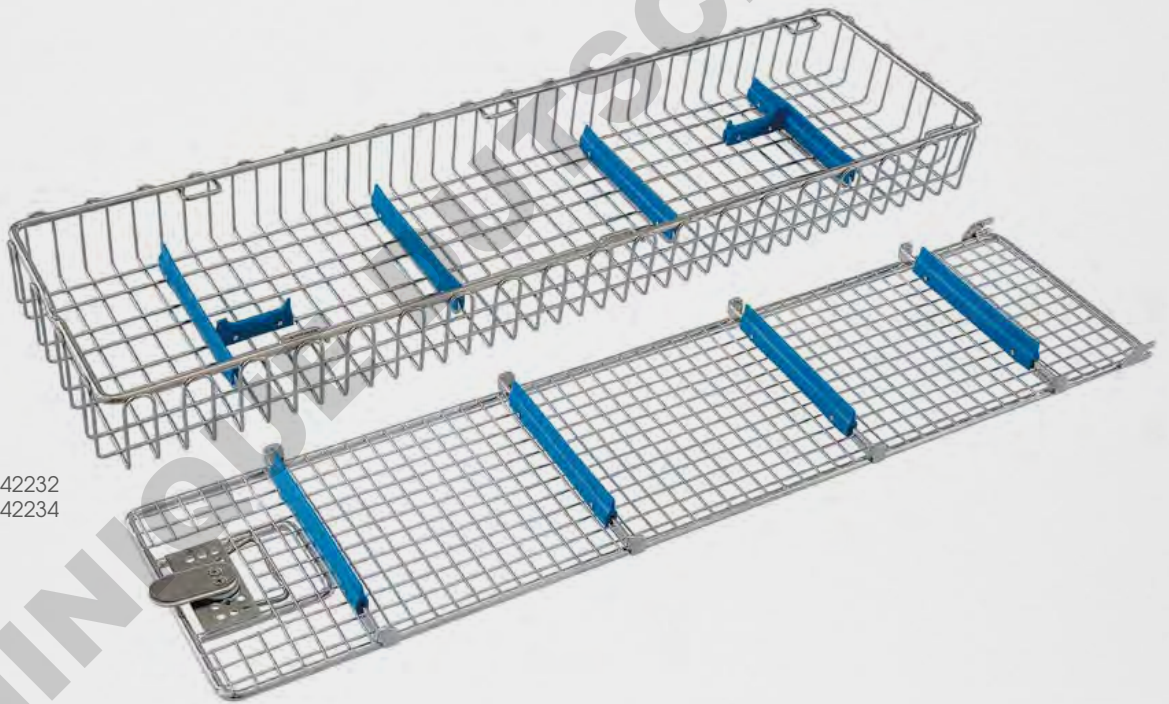

3FEDS842232
3FEDS842234

Endoscope baskets made of stainless steel with silicone holders For optimized organization of optics

Endoscope baskets offer safe protection for expensive and sensitive endoscopes during the entire reprocessing or use cycle and are equipped with a twist lock.

The silicone pads on the base and lid provide a stable hold without damaging the endoscopes and lenses.

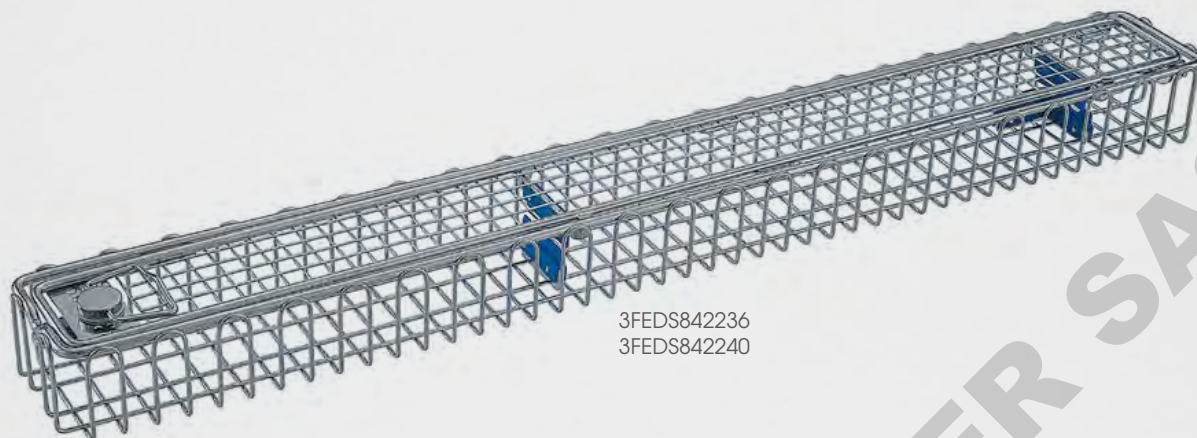

3FEDS842236
3FEDS842240

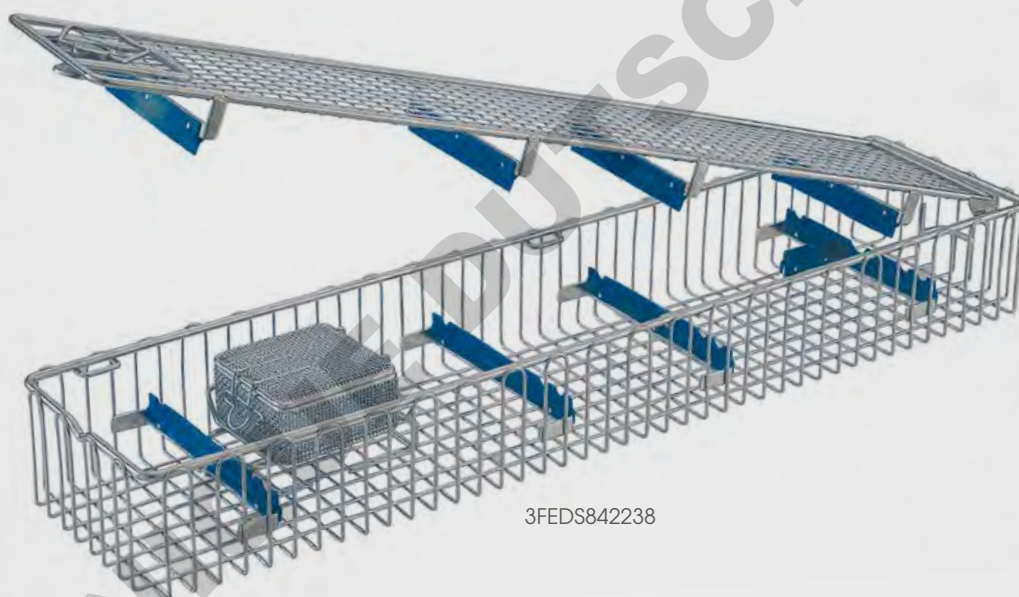

3FEDS842238

Article No.	Description	Dimensions L x W x H (mm)
3FEDS842222	For one lens	180 x 80 x 52
3FEDS842224	For one lens	290 x 80 x 52
3FEDS842226	For two lenses	290 x 80 x 52
3FEDS842228	For one lens	460 x 80 x 52
3FEDS842230	For two lenses	460 x 80 x 52
3FEDS842232	For one lens	580 x 160 x 52
3FEDS842234	For two lenses	580 x 160 x 52
3FEDS842236	For one lens	670 x 80 x 52
3FEDS842240	For one lens	800 x 80 x 52
3FEDS842238	With integrated tray for small parts / for one lens	640 x 150 x 77

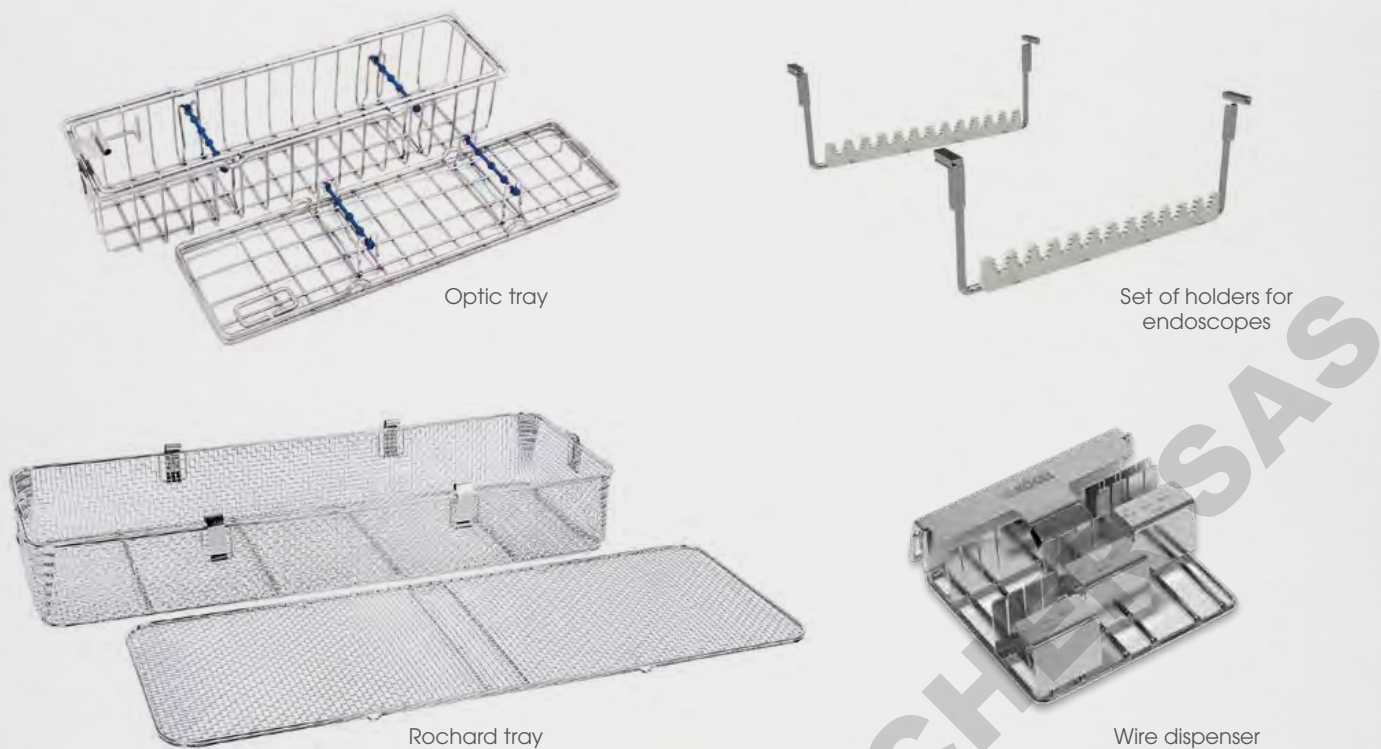

Kögel optics and endoscopy baskets

For optimized organization of optics

Kögel optics and endoscopy baskets with safe-to-handle double frame provide secure protection for expensive and sensitive endoscopes during the entire reprocessing or use cycle and are equipped with a removable lid and locking clip. Storage via silicone ball chains provide stable support without damaging the endoscopes and optics. Depending on the design, the baskets can be loaded with one or two optics.

Article No.	Description	Dimensions L x W x H (mm)
3FEDS850273	Optic tray 294, for one optic, incl. lid, clips and silicon chains, mesh size: 17,5 x 17,5 x 2 mm	294 x 84 x 69
3FEDS850274	Optic tray 294, for two optics, incl. lid, clips and silicon chains, mesh size: 17,5 x 17,5 x 2 mm	294 x 84 x 69
3FEDS850275	Optic tray 445, for one optic, incl. lid, clips and silicon chains, mesh size: 17,5 x 17,5 x 2 mm	445 x 84 x 69
3FEDS850276	Optic tray 445, for two optics, incl. lid, clips and silicon chains, mesh size: 17,5 x 17,5 x 2 mm	445 x 84 x 69
3FEDS850277	Optic tray 674, for one optic, incl. lid, clips and silicon chains, mesh size: 17,5 x 17,5 x 2 mm	674 x 84 x 69
3FEDS850278	Optic tray for storage of one Da Vinci optic, incl. lid, clips and silicon mounting, mesh size: 17,5 x 17,5 x 2 mm	674 x 84 x 80
3FEDS850279	Rochard tray, incl. lid and clips, mesh size: 5 x 5 x 1 mm	725 x 275 x 105
3FEDS850280	Set of holders for endoscopes	257 x 97 x Ø 6
3FEDS850398	Wire dispenser for holding various types of wires, Ø 0.6; 0.8; 1.0 mm, with diameter gauge, wires in 60 - 100 mm lengths, suitable for the most common cleaning, disinfection and sterilization processes	

EVERYTHING FOR THE CSSD

steriCLIN®

Bowie-Dick Helix Test

Entspricht / conforms to ISO 1140-4

STEAM Temp. 135 °C Time 3,5 min.



max. 250 Zyklen / cycles

3FSK5612102

3028492

1.2.2018

Papier-Produktionsunternehmen
Industriestraße 6 · D-91555 Feuchtwangen
Tel. (0) 9852 901-188 · Fax (0) 9852 901-189
www.stericlein.com



steriCLIN®

Vereinigte Papierwarenfabriken GmbH
Industriestraße 6 · D-91555 Feuchtwangen

Tel. +49 (0) 9852 901-289

contact@stericlein.com

www.stericlein.com