

# Cole-Parmer<sup>®</sup>

## HM-200 & SHM-200 Series

### Heating Mantles

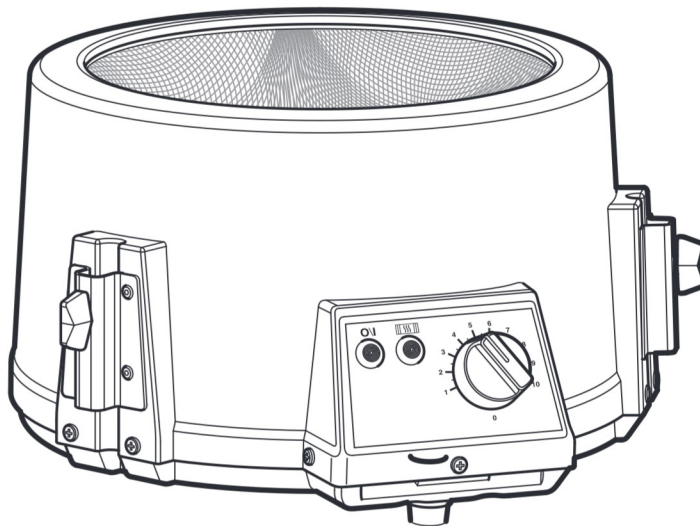
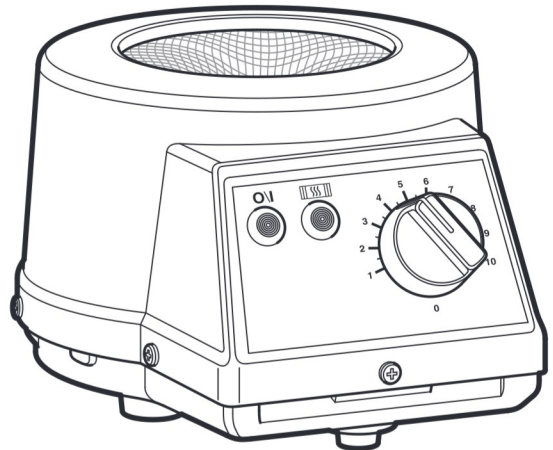
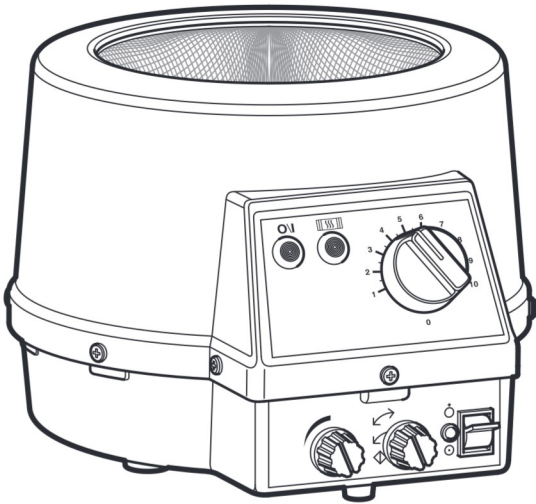

Instruction Manual  
M6873-CPB Version 12.9

**Cole-Parmer<sup>®</sup>**  
essentials

**Please take your time to read this Instruction Manual in order to understand the safe and correct use of your new Cole-Parmer product.**

**It is recommended the Responsible Body for use of this equipment reads this Instruction Manual and ensures the user(s) are suitably trained in its operation.**

### **Contents.**

|                    |  |                |
|--------------------|--|----------------|
| <b>Section 1.</b>  | <b>Introduction.</b>                               | <b>Page 3</b>  |
| <b>Section 2.</b>  | <b>Symbols and using this Instructions Manual.</b> | <b>Page 4</b>  |
| <b>Section 3.</b>  | <b>Safety Information.</b>                         | <b>Page 5</b>  |
| <b>Section 4.</b>  | <b>Unpack and Contents.</b>                        | <b>Page 7</b>  |
| <b>Section 5.</b>  | <b>Installation.</b>                               | <b>Page 9</b>  |
| <b>Section 6.</b>  | <b>Environmental Protection.</b>                   | <b>Page 10</b> |
| <b>Section 7.</b>  | <b>Product Operation.</b>                          | <b>Page 11</b> |
| <b>Section 8.</b>  | <b>Technical Specification.</b>                    | <b>Page 14</b> |
| <b>Section 9.</b>  | <b>Maintenance.</b>                                | <b>Page 19</b> |
| <b>Section 10.</b> | <b>Replaceable Parts and Accessories.</b>          | <b>Page 22</b> |
| <b>Section 11.</b> | <b>Customer Support.</b>                           | <b>Page 24</b> |
| <b>Section 12.</b> | <b>Notes.</b>                                      | <b>Page 25</b> |
| <b>Section 13.</b> | <b>Declaration of Conformity.</b>                  | <b>Page 26</b> |

*© The copyright of this instruction manual is the property of Antylia Scientific Ltd. This instruction manual is supplied by Antylia Scientific Ltd on the express understanding that it is to be used solely for the purpose for which it is supplied. It may not be copied, used or disclosed to others in whole or part for any purpose except as authorised in writing by Antylia Scientific Ltd. Antylia Scientific Ltd. reserves the right to alter, change or modify this document without prior notification.*

*In the interest of continued development Antylia Scientific Ltd. reserve the right to alter or modify the design and /or assembly process of their products without prior notification.*

**This product is manufactured in the United Kingdom by Antylia Scientific, part of Antylia Scientific Ltd.**

**Antylia Scientific Ltd.**  
Beacon Road,  
Stone,  
Staffordshire,  
ST15 0SA,  
United Kingdom  
Tel: +44 (0)1785 812121

## 1. INTRODUCTION.

- 1.1. The Cole-Parmer series of heating mantles has been specifically designed to provide a comprehensive answer to heating fluids in round bottomed glassware in the modern laboratory. It combines the traditional Cole-Parmer heating element with many new features thus providing the user with several options to meet different applications.
- 1.2. Heating control is provided by a built-in solid state energy regulator. Non stirring mantles can be used with an external controller. (Please contact distributor / manufacturer for details).
- 1.3. The enclosures of the HM-200, SHM-200, HM-200-V and HM-200-SP individual heating mantles are manufactured from chemical resistant Polypropylene.
- 1.4. The products are provided with ventilation slots underneath and around the rim to ensure a low enclosure surface temperature. The heating element is retained in thermal Rockwool to create a heating cartridge that facilitates very easy replacement in the event of any damage. On all sizes up to 1 litre, a single support clamp is provided at the rear of the unit. On the 2, 3 and 5 litre models there are three rod support clamps. The HM-200-V and HM-200-SP range have a hole in the base to enable funnels or bottom outlet flasks to be heated. All models are supplied with support rods and clamps.
- 1.5. Antylia Scientific offers a comprehensive range of Mantles, and Controllers. The Mantles range from the Standard cool-to-touch vented case, with element temperatures between ambient and 450 deg C. The Standard Individual HM-200 Mantle range has configurations Spill-Proof (HM-200-SP), V-Shaped (HM-200-V) and Heating and Stirring (SHM-200 range) with single or bi-directional stirring options. Capacities for round-bottomed glassware ranging from 50ml up to 5,000ml, plus funnel options. Replacement heater cartridges are available.





















## 2. SYMBOLS AND USING THIS INSTRUCTION MANUAL.

2.1. Throughout this Instruction Manual the following symbols are shown to identify conditions which pose a hazard to the user, or to identify actions that should be observed. These symbols are also shown on the product, or its packaging. When a symbol is shown next to a paragraph or statement it is recommended the user takes particular note of that instruction in order to prevent damage to the equipment or to prevent injury to one's self or other people.

**The Responsible Body and the Operator should read and be familiar with this Instruction Manual in order preserve the protection afforded by the equipment.**

**To prevent injury or equipment damage it is the manufacturers recommendation that all persons using this equipment are suitably trained before use.**

### 2.2. Symbols defined.

|   |   |   |   |
|---|---|---|---|
|    | Caution, risk of danger. See note or adjacent symbol.   |    | This symbol adjacent to an indication lamp means mains power Off/On when lamp non-illuminated / illuminated         |
|    | Protective conductor terminal to be earthed.<br><b>(Do not loosen or disconnect).</b>                   |    | This symbol adjacent to a switch denotes the Off condition for mains power.   |
|    | Caution / risk of electric shock  |    | This symbol adjacent to a switch denotes the ON condition for mains power.  |
|   | Recyclable Packing Material.  |   | This symbol adjacent to a switch denotes the Off condition for the Heater or Stirrer.                               |
|  | Do not dispose of product in normal domestic waste.   |  | This symbol adjacent to a switch denotes the On condition for a Heater or Stirrer.                                  |
|  | Caution. Hot surface.   |  | This symbol indicates an output terminal for the equipment.   |
|  | Refer to Instruction Manual.  |  | This symbol indicates an input terminal for the equipment.  |
|  | This symbol denotes stirrer speed control.  |  | This symbol adjacent to an indication lamp means the heater power Off / On when lamp non-illuminated / illuminated. |
|  | This symbol adjacent to the stirrer switch denotes the bi-directional stir condition with auto-reverse. |  | This symbol adjacent to the stirrer switch denotes the uni-directional stir condition.                              |
|  | <i>Material irritant to skin. When handling wear face mask to BS/EN 149 and protective gloves</i>       |  | This symbol adjacent to the stirrer switch denotes the stirrer manual capture condition or stirrer off.             |
|   |   |  | Bio Chemical Hazard. Caution required. Will require decontamination.  |

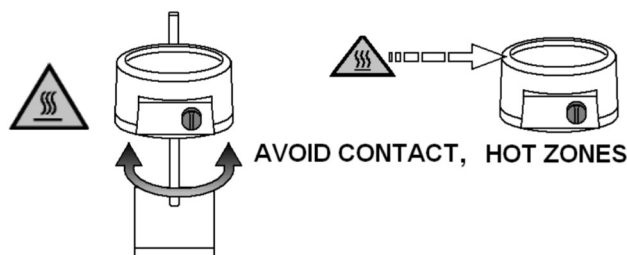

### 3. SAFETY INFORMATION.

This product has been designed for safe operation when used as detailed in accordance with the Manufacturers instructions.

**NOTE:** Failure to use this equipment in accordance with the manufactures instruction manual may compromise your basic safety protection afforded by the equipment and may invalidate the warranty / guarantee. The warranty / guarantee does not cover damaged caused by faulty installation or misuse of the equipment

#### 3.1. Prevention of Fire and Electric Shock.



To prevent a risk of fire or electric shock, **DO NOT** open your *product* case without authorisation. Only qualified Service personnel should attempt to repair this product.



Replace fuses only with the type as listed in section, 'Technical Specifications and Parts and Accessories' (See fuse type and rating).



Ensure the Mains Power Supply conforms to rating found on the data plate located on the back of this product.



**Never** Operate this equipment without connection to earth / ground. Ensure the mains supply voltage is correctly earthed / grounded in accordance with current area legislation.

#### 3.2. General Safe Operating Practice.



Always follow good laboratory practice when using this equipment. Give due recognition to your company's safety and legislative health & safety procedures and all associated legislation applicable to your areas of operation. Check laboratory procedures for substances being heated and ensure all hazards (e.g. explosion, implosion or the release of toxic or flammable gases) that might arise have been suitably addressed before proceeding. When heating certain substances the liberation of hazardous gases may require the use of a fume cupboard or other means of extraction.



Ensure equipment is used on a clean, dry, non-combustible, solid work surface with at least 300mm suitable clearance all around from other equipment.



**Do not** position the product so that it is difficult to disconnect from the mains supply.



**Do not** touch the heating element or any glass vessel whilst in use.



**Do not** lean or stretch over equipment, glassware and fixings when in use.



**Do not** immerse unit in water or fluids.



**Do not** spill substances onto the mantle. If spillage does occur, disconnect unit from mains supply and follow instructions as detailed in Maintenance. (Section 9).



**Do not** cover the mantle whilst in use. **Do not** block or obstruct ventilation slots / airways.



**Do not** leave equipment switched on without a charged flask(s).



**Do not** thermally insulate the exposed upper section of the vessel(s), as the insulation used may obstruct the convection cooling airways around the rim of the cartridge enclosure and cause the mantle to overheat.



It is not recommended to leave any heating apparatus unattended during operation.



Only use Original Equipment manufactures spares and accessories. Ref Section 10.



Stirring versions of this equipment generate magnet fields. Keep all metal objects and magnetic data devices (e.g. credit cards) away from the stirrer unit.



The equipment is not spark, flame or explosion proof and has not been designed for use in hazardous areas in terms of BSEN 60079-14:1997. Keep flammable, low flash point substances away from the apparatus.



**Do not** operate or handle any part of the product with wet hands.



Keep the Mains cord and moulded IEC plug and lead set away from the heating surface.



**ATTENTION:-**

With high energy input and certain configurations of glassware in EMV & EMX products, where the heating contact of the glassware is relatively small, localised heating and subsequent 'bumping' of the fluid being heated may occur. Application advice should be sought from the manufacturer.

## 4. UNPACKING AND CONTENTS.

### 4.1. Product Identification:

The model number allocated to each type of mantle is descriptive. The method of coding is detailed below.

### STIRRING AND NON-STIRRING MODELS

#### Example

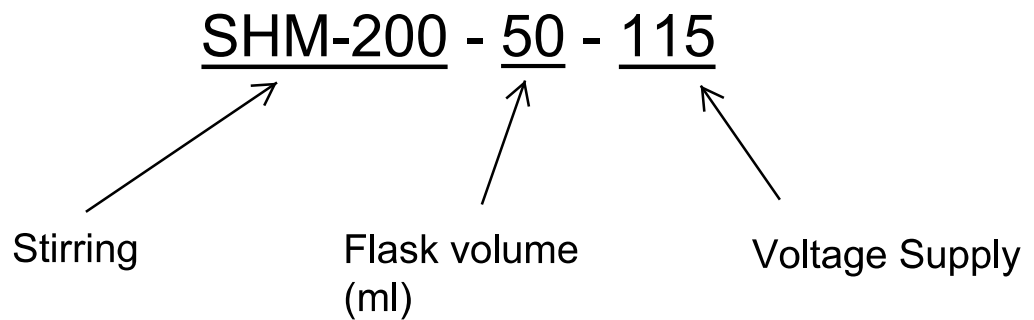

Note: Non-Stirring models are prefixed "HM-200"

HM-200 flask volume: 50ml, 100ml, 250ml, 500ml, 1000ml, 2000ml, 3000ml, 5000ml

SHM-200 flask volume: 50ml, 100ml, 250ml, 500ml, 1000ml

Supply Voltage: Model numbers not suffixed "-115" = 230V a.c

### SPILLPROOF AND FUNNEL MODELS (WITH OPENING IN BASE)

#### Example

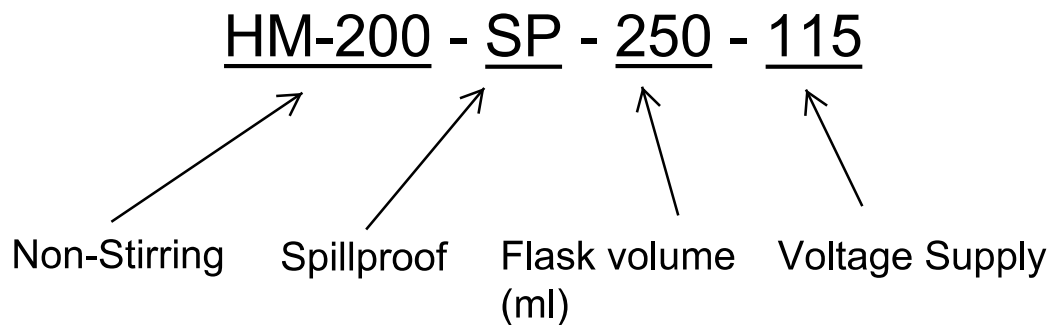

Note: Non-Stirring models only

Heating area configuration: SP = Spillproof (Stainless Steel liner) with opening in base for funnel  
V = Opening in base for funnel

HM-200-SP flask volume: 1000ml, 5000ml

SHM-200-V flask volume: 50ml, 250ml, 1000ml

Supply Voltage: Model numbers not suffixed "-115" = 230V a.c

Please check the contents of your carton against the relevant product diagram.

Applicable to all HM-200 and SHM-200 product Range.

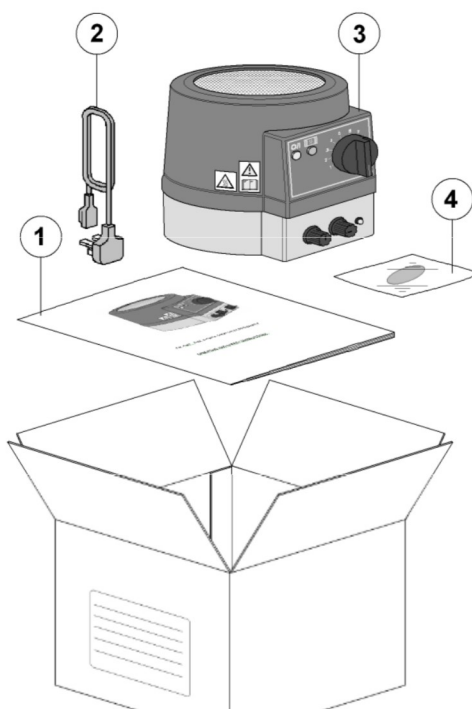

| Item No | Description   | Qty |
|---------|---|-----|
| 1       | Instruction manual  | 1   |
| 2       | Mains cord and moulded IEC plug and lead set                    | A/R |
|         | <i>(May differ from illustration depending on destination).</i> |     |
| 3       | Product ( <i>Model shown SHM-200</i> )                          | 1   |
| 4       | Stir bar ( <i>only on SHM-200</i> )                             | 1   |

|  |                      |                              |
|--|----------------------|------------------------------|
| For future reference please record your products Serial and Model Numbers. | <b>Serial Number</b> | <b>Unit Model/Cat Number</b> |
|  |                      |                              |



## 5. INSTALLATION.

### 5.1. Electrical safety and installation.

5.1.1. This equipment is designed to be used safely under the following conditions:-

- Indoor use.
- Altitude up to 2000 meters.
- Temperatures between 5°C and 40°C.
- Maximum relative humidity 80% for temperatures up to 31°C decreasing linearly to 50% relative humidity at 40°C.
- Mains supply voltage fluctuations up to  $\pm 10\%$  of the nominal voltage.
- Transient overvoltages typically present on the mains supply. Overvoltage category II
- Applicable rated pollution degree 2.

5.1.2.  This equipment must be earthed / grounded to a fixed earth / grounded mains socket outlet. The mains supply is to earthed / grounded in accordance with current legislation. See Technical Specification for recommended fuse ratings.

5.1.3. Ensure only the correct rated mains input fuses are fitted. (Where applicable ensure the correct Mains cord and moulded IEC plug and lead set fuse if fitted). See Technical Information Section 8 of this Instructions Manual.

5.1.4. Check the voltage on the product data label on this product unit and those of any accompanying electrical accessory. Ensure the rating conforms to your local supply.

5.1.5. This product should be connected to a mains supply source which incorporates a RCD or GFCI device that has a tripping current of 30mA or less. The RCD or GFCI residual Current Device cuts off power to the equipment immediately it detects a current leakage fault. For example, cutting off the power when there is an accidental liquid spillage in a mantle protected with an earth (ground) screen.

5.1.6.  Do not install this product or accessories on a surface which may become flooded.

5.1.7. The unit is supplied with a Mains cord and moulded IEC plug and lead set wired as follows.



**Green / Yellow** or **Green** = **Earth / Ground**

**Blue** or **White** = **Neutral**

**Brown** or **Black** = **Live / line hot.**

5.2. **Observation:** the surface of the heating element of a mantle cartridge will upon receipt look slightly discoloured. This discolouration is normal and occurs at the factory during test when the mantle is first heated up.

5.3. Cole-Parmer controllers, series CN-200-2300 / CN-200-1100-115 / CN-200-1800 / CN-200-800 and CN-200D, can also be used for external control when the mantle is used in a fume cupboard. NOTE: External controllers cannot be used for EMA or EMEA products.

### **USA Notification.**

**Warning!** Any modification or changes made to this device, unless explicitly approved by Antylia Scientific, will invalidate the authorisation of this device. Operation of an unauthorised device is prohibited under Section 302 of the Communications Act of 1934 as amended, and Subpart 1 of Part 2 of Chapter 47 of the code of Federal Regulations.

**Note:** This equipment has been tested and found to comply with the limits for a Class B digital device, pursuant to part 15 of the FCC Rules. These limits are designed to provide reasonable protection against harmful interference in a residential installation. This equipment generates, uses and can radiate radio frequency energy and, if not installed and used in accordance with the instructions, may cause harmful interference to radio communications. However, there is no guarantee that interference will not occur in a particular installation. If this equipment does cause harmful interference to radio or television reception, which can be determined by turning the equipment off and on, the user is encouraged to try to correct the interference by one or more of the following measures:

- Reorient or relocate the receiving antenna.
- Increase the separation between the equipment and receiver.
- Connect the equipment into an outlet on a circuit different from that to which the receiver is connected.
- Consult the dealer or an experienced radio/TV technician for help.

## **6. ENVIRONMENTAL PROTECTION.**

6.1. Maximum consideration has been given to environmental issues within the design and manufacturing process without compromising end product performance and value.



6.2. Packaging materials have been selected such that they may be sorted for recycling.



6.3. At the end of your product and accessories life, it must not be discarded as domestic waste. Ref: EU Directive 2002/96/EC on Waste Electrical and Electronic Equipment Directive (WEEE). Please contact your distributor / supplier for further information. For end users outside of the EU consult applicable regulations.

6.4. This product should only be dismantled for recycling by an authorised recycling company.



**This product and accessories must be accompanied by a completed Decontamination Certificate prior to any disposal. Copies of the Certificate are available from Distributor/Manufacturer.**

## 7. PRODUCT OPERATION.

### 7.1. HM-200, SHM-200 HM-200-V and HM-200-SP Mantle with controller.

#### 7.1.1. Overview of HM-200 Mantle with controller.

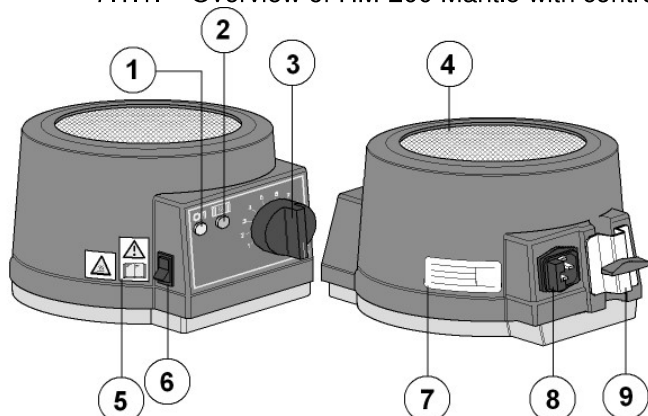

**Note:** Circuit selection switch (only for mantles with two heating circuits).

Position I is for lower heating circuits only.  
Position II is for both circuits on.

**Note:** If an external controller is to be used, always set the energy regulator control knob to maximum setting 10.

| Item | Description.  |
|------|---|
| 1    | Mains power on indicator  |
| 2    | Heating element on  |
| 3    | Energy regulator control knob   |
| 4    | Heating Element  |
| 5    | Warning Labels.<br><b>(Hot surface and refer to this Instructions Manual).</b>                      |
| 6    | Circuit selection switch (for mantles with two heating circuits)                                    |
| 7    | Data Plate  |
| 8    | Mains input IEC socket ( <b>Contains protective fuses</b> ).  |
| 9    | Support rod bracket. ( <b>Note for 2, 3 &amp; 5 litre variants 3 clamp positions are fitted</b> ).  |

**Note:** The **SHM-200-V** and **SHM-200-SP** series mantles both have bottom opening for use with a funnel. SHM-200-SP has a spill proof liner. Both units may be raised up using a retort rod stand allowing for heated filtration of the sample.

Both mantles can be supported using the rod clamp arrangement as illustrated.

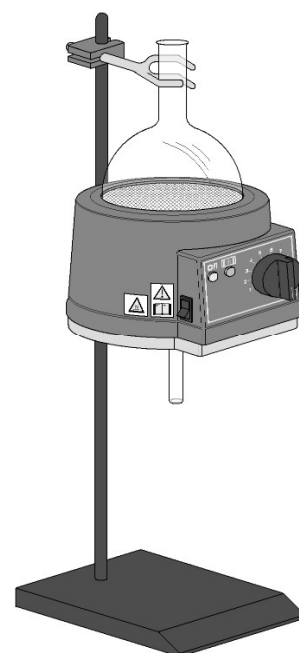

7.1.2.  When heating a funnel in an HM-200-V or HM-200-SP the mantle should be securely supported above the work surface using the support rod clamps.

7.1.3. With the mains electricity supply switched off, connect the Mains cord and moulded IEC plug and lead set to the mains IEC socket.

7.1.4. Place a charged, clean, dry glass vessel of the size indicated on the mantle data plate label. Wherever possible the glass vessel should be supported within the mantle by means of the support rod and clamp.

7.1.5. Switch on the mains electrical supply. Adjust the controller regulator knob to the required setting.

**NOTE: The 'mains power on' indication neon will illuminate. The 'amber heating on' neon will illuminate / pulsate when the heaters are in operation.**

7.1.6. When the process is complete switch the regulator knob to the off position. Disconnect the mains electricity supply.

7.1.7.  Remove charged vessel. Handle hot charged vessel with care.

## 7.2. SHM-200 Mantle (With controller and stir facility).

7.2.1. Overview of SHM-200 Mantle with stir facility.

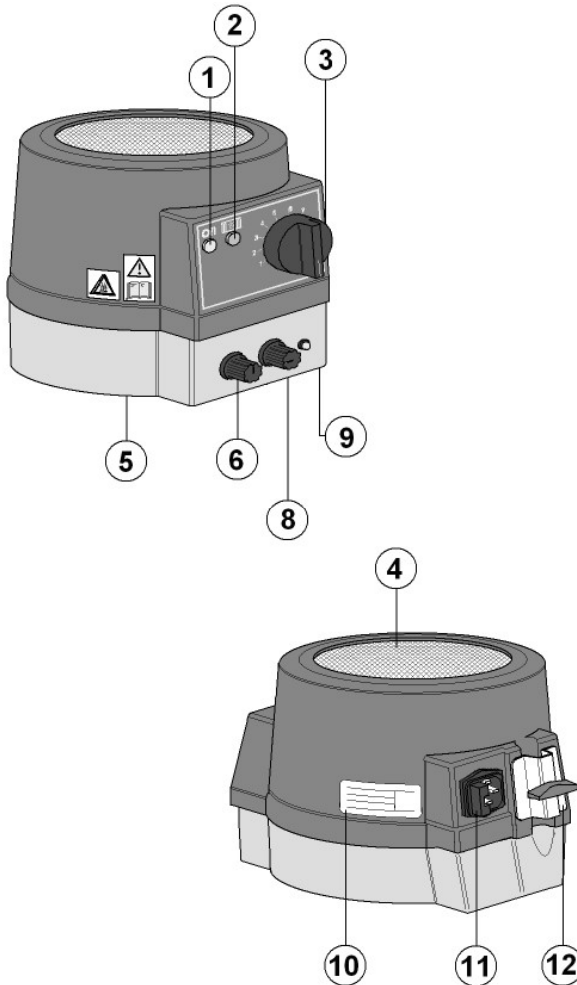



| Item | Description.  |
|------|---|
| 1    | Mains power on indicator  |
| 2    | Heating element on  |
| 3    | Energy regulator control knob   |
| 4    | Heating Element  |
| 5    | Warning Labels. <b>(Hot surface and refer to this Instructions Manual).</b>                           |
| 6    | Stir speed adjustment.  |
| 8    | Stir selection rotary switch.   |
| 9    | Stir facility 'on' LED indicator.   |
| 10   | Data Plate  |
| 11   | Mains input IEC socket <b>(Contains protective fuses).</b>  |
| 12   | Support rod bracket. <b>(Note for 2, 3 &amp; 5 litre variants 3 clamp positions are fitted).</b>      |

- 7.2.2. With the mains supply electricity switch off, Connect the Mains cord and moulded IEC plug and leads set to the mains IEC socket. Ensure the stirrer rotary switch is in the off position.
- 7.2.3. Place a charged, clean, dry glass vessel of the size indicated on the mantle data plate. Wherever possible the glass vessel should be supported within the mantle by means of the support rod and clamp.
- 7.2.4. Switch on the mains electrical supply. Adjust the Energy regulator control knob to the required setting.

**NOTE: The mains power on indication neon will illuminate. The amber heating on neon will illuminated when the heaters are in operation.**

- 7.2.5. On the SHM-200 there are two stirring functions available.
- a) Bi-directional with auto capture and auto reverse period of approximately 20 / 30 seconds.
  - b) Uni-directional up to 500RPM approximately.
  - c) Manual capture / reset is achieved with the rotary switch in the off position.
- 7.2.6. Carefully place the stirrer bar provided into the vessel and turn the rotational speed control to its minimum position.
- 7.2.7. Select the required stir function on the stir selection rotary switch. The green LED will now illuminate.
- 7.2.8. Adjust the rotational speed by means of the speed control knob. Should the stirring action be lost by over rotation, then reduce the stir speed slightly and recapture the stir bar by selecting the off position on the stir selection rotary switch
- 7.2.9. When the process is complete switch the stir speed and regulator knobs to there off positions. Disconnect the mains electricity supply.

- 7.2.10.   Remove charged vessel. Handle hot charged vessel with care.

## 8. TECHNICAL SPECIFICATION.

### 8.1. Specifications HM-200 range (General).

|                               |  |
|-------------------------------|--|
| Fuse type                     | 20mm x 5mm Glass Quickblow. (2 per unit) See below for rating.         |
| Heating Element Construction. | Thermal insulated element wire stitched into a cartridge construction. |
| Maximum Element temperature.  | 450°C. Nominal Max.  |
| EM Case construction.         | Polypropylene.   |
| Thermal Insulation            | Ceramic Fibre.   |

#### 8.1.1. Power Consumption and fuse ratings.

| Type             | Size   | Total Heating Power (Watts). |              | Fuse rating (Amps) |       |
|------------------|--|------------------------------|--------------|--------------------|-------|
|                  |  | 220/240V~                    | 115V~        | 220/240V~          | 115V~ |
| <b>HM-200</b>    | 50ml   | 60                           | 70           | F0.5               | F1.25 |
|                  | 100ml  | 60                           | 70           | F0.5               | F1.25 |
|                  | 250ml  | 150                          | 150          | F1.25              | F2.5  |
|                  | 500ml  | 200                          | 200          | F1.25              | F2.5  |
|                  | 1000ml   | 300                          | 300          | F2.5               | F3.15 |
|                  | 2000ml   | 500                          | 500          | F2.5               | F6.3  |
|                  | 3000ml   | 500                          | 500          | F2.5               | F6.3  |
|                  | 5000ml   | 500+300                      | 500+300      | F6.3               | F6.8  |
| <b>SHM-200</b>   | 50ml   | 60+(20stir)                  | 76+(20stir)  | F0.5               | F1.25 |
|                  | 100ml  | 60+(20stir)                  | 76+(20stir)  | F0.5               | F1.25 |
|                  | 250ml  | 150+(20stir)                 | 190+(20stir) | F1.25              | F2.5  |
|                  | 500ml  | 200+(20stir)                 | 250+(20stir) | F1.25              | F2.5  |
|                  | 1000ml   | 300+(20stir)                 | 380+(20stir) | F2.5               | F6.3  |
|                  | 2000ml   | 500+(20stir)                 | 650+(20stir) | F2.5               | F6.3  |
|                  | <b>The power consumption of the stir facility is 20 Watts.</b> |                              |              |                    |       |
| <b>HM-200-V</b>  | 50ml   | 60                           | 70           | F0.5               | F1.25 |
|                  | 250ml  | 100+50                       | 100+50       | F1.25              | F2.5  |
|                  | 1000ml   | 200+100                      | 200+100      | F2.5               | F3.15 |
|                  | 5000ml   | 500+300                      | 500+300      | F6.3               | F8    |
| <b>HM-200-SP</b> | 1000ml   | 165+80                       | 160+80       | F1.25              | F2.5  |
|                  | 5000ml   | 400+200                      | 400+200      | F6.3               | F10   |

8.1.2. The Ingress protection rating for the HM-200, HM-200-MP3 & MP6, HM-200-V SHM-200 product range is IPX0.

For the HM-200-SP range the Ingress protection rating is IPX1.

8.1.3. Dimensions and Weight (unpacked).

HM-200-50

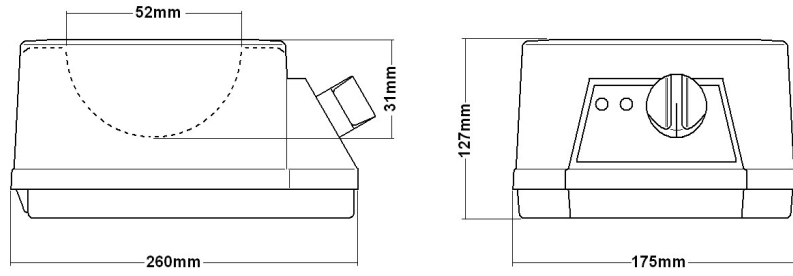

WEIGHT 0.78Kg

HM-200-100

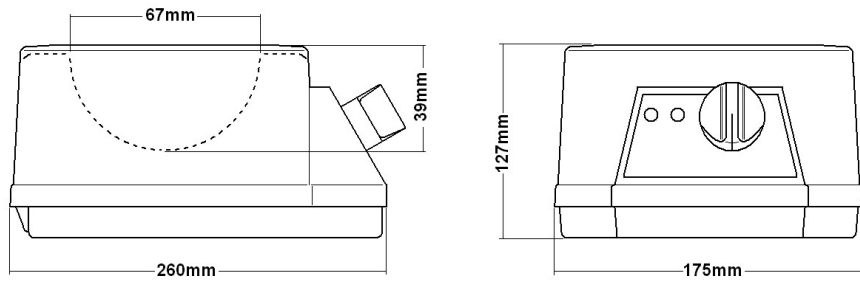

WEIGHT 0.78Kg

HM-200-250

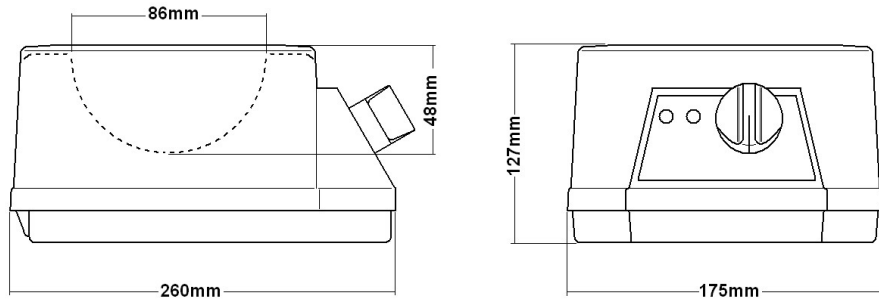

WEIGHT 0.78Kg

HM-200-500

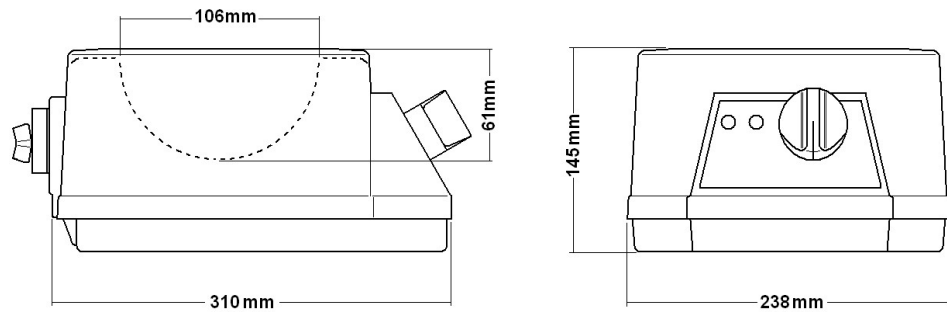

WEIGHT 1.25Kg

**HM-200-1000**

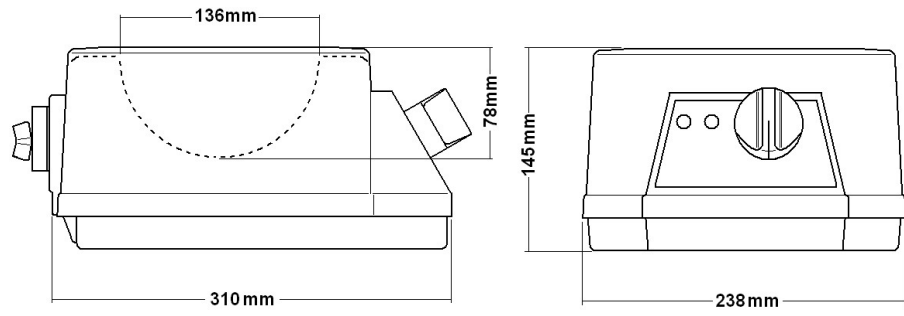

**WEIGHT 1.25Kg**

**HM-200-2000**

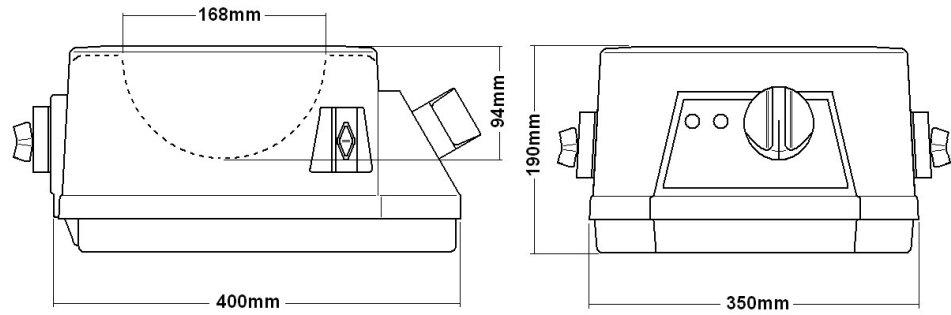

**WEIGHT 2.58Kg**

**HM-200-3000**

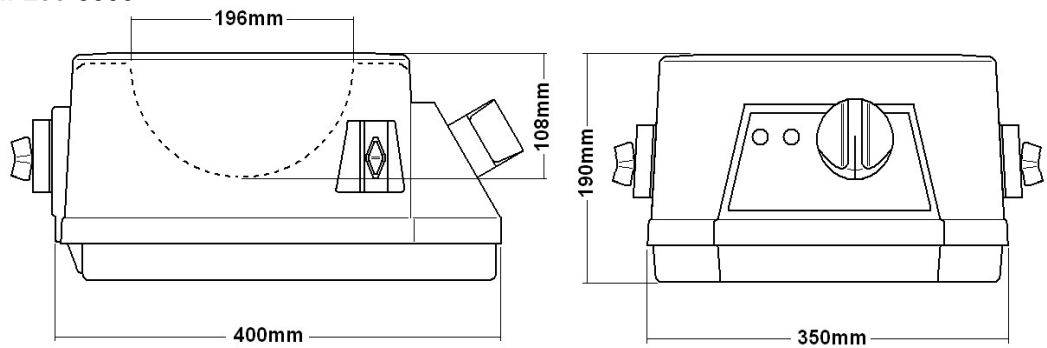

**WEIGHT 2.58Kg**

**HM-200-5000**

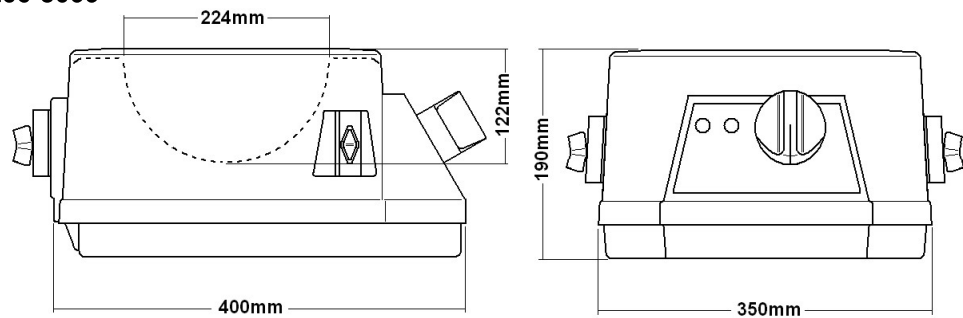



**HM-200-V-50. Glass sizes 10 – 50ml.**

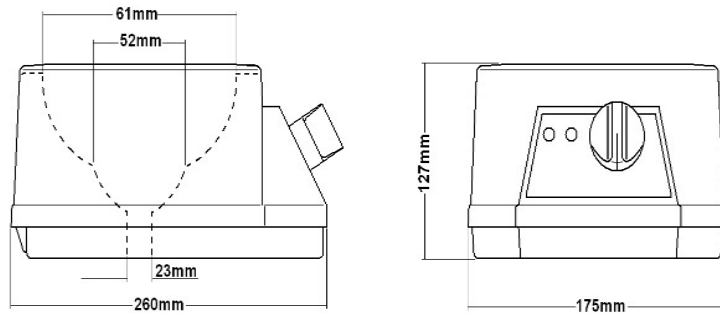

**WEIGHT 0.78Kg.**

**HM-200-V-250. Glass size 100 – 250ml.**

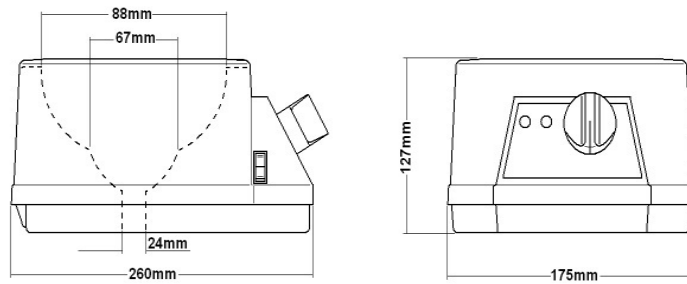

EMV0250/CE

**WEIGHT 0.78Kg.**

**HM-200-V-1000. Glass size 500 – 1000ml**  
**HM-200-SP-1000 Glass size 50 to 1000ml**

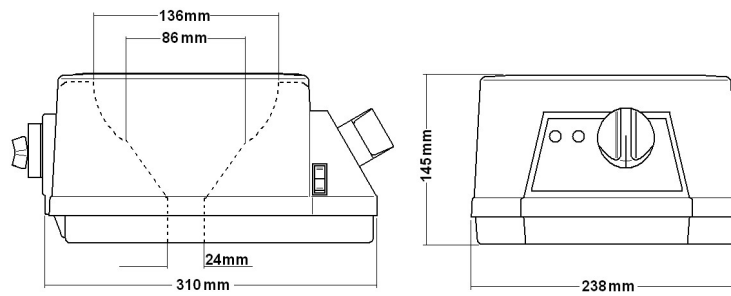

**WEIGHT 2.76Kg**

**HM-200-V-5000. Glass size 2000 – 5000ml.**  
**HM-200-SP-5000 Glass size 500 to 5000ml**

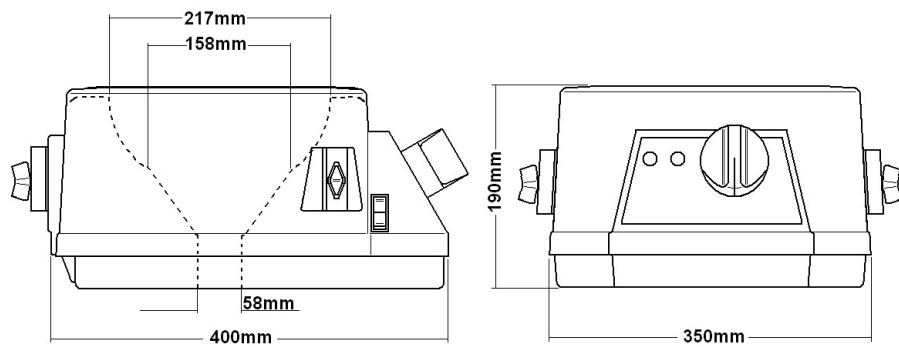

**WEIGHT 5.69Kg**

**SHM-200-50**

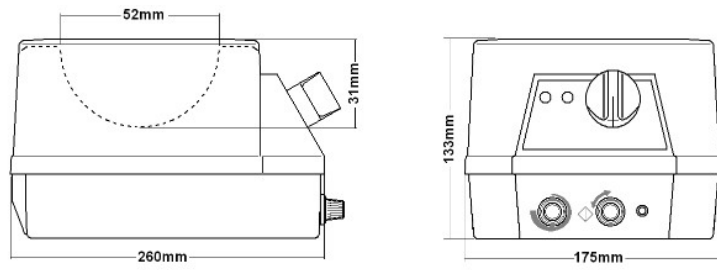

**WEIGHT 1.73Kg**

**SHM-200-250**

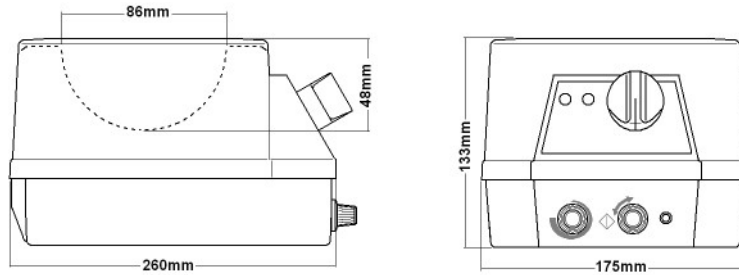

**WEIGHT 1.73Kg.**

**SHM-200-500**

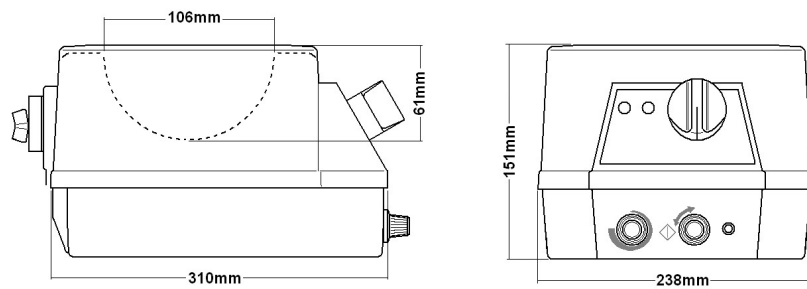

**WEIGHT 2.75Kg.**

**SHM-200-1000**

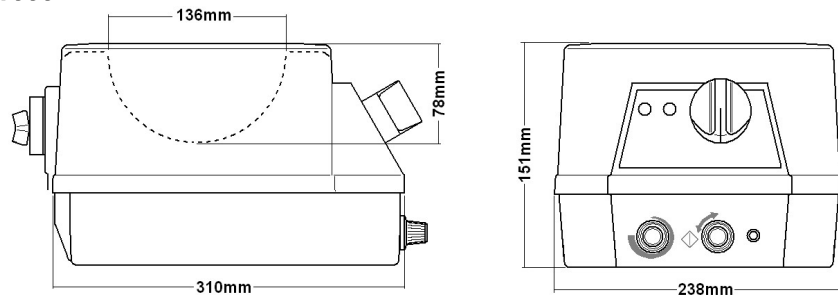

**WEIGHT 2.75Kg**

**SHM-200-2000**

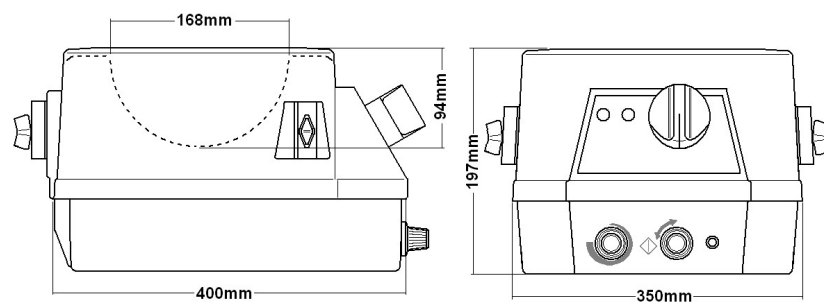

**WEIGHT 5.68Kg**

## 9. MAINTENANCE.

### 9.1. General Information.



Unplug the unit from the mains voltage supply and allow it to cool before undertaking any maintenance tasks.



Maintenance should only be carried out under the direction of the Responsible Body, by a competent electrician. Failure to do so may result in damage to the product and in extreme cases be a danger to the end user.

With proper care in operation this equipment has been designed to give many years of reliable service. Contamination or general misuse will reduce the effective life of this product and may cause a hazard.

Maintenance for the unit should include:

- Periodic electrical safety testing (an annual test is recommended as the minimum requirement).
- Regular inspection for damage with particular attention to the mains lead and plug set.
- Routine cleaning of the equipment should be undertaken using a clean cloth.

**DO NOT USE SOLVENTS FOR CLEANING ANY PART OF THIS EQUIPMENT.**

### 9.2. Fuse Replacement.

The mains fuse holder is located at rear your product. Refer to Technical specification, 'Fuse Rating' for correct fuse type and rating. Turn your product off and disconnect it from the mains supply.

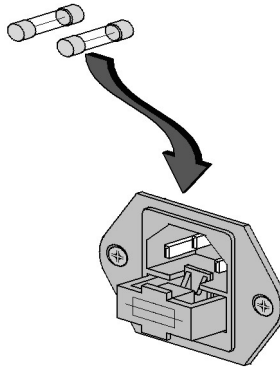

#### 9.2.1. Heater Cartridge replacement.



**Attention.** The heater contains insulation material made from Refractory Ceramic Fibres (RCF), classified as a category 2 carcinogenic under EU Directive 67/548/EC. Follow the guidelines for working with RCF as laid down under in the ECFIA Code of Practise. Wear suitable protective clothing and gloves.



In the event of a heater element becoming damaged or open circuit the follow procedure should be adopted for its replacement.

#### **HM-200 and SHM-200**

- 9.2.1.1. Unplug or disconnect the mantle from the mains electricity supply.
- 9.2.1.2. The **(S)HM-200** single heater mantles should be turned over and placed upside down on a clean dry surface.
- 9.2.1.3. Remove the plastic rivets from around the base of the mantle and remove the base.
- 9.2.1.4. On 2,3 and 5 litre models remove the 3 cross-head screws and remove the triangular base plate.
- 9.2.1.5. On **(S)HM-200** product remove the 2 cross-head screws retaining the base bracket then hinge the bracket clear of the heater cartridge.
- 9.2.1.6. Disconnect the two or four heater cold leads. (The number of leads is dependant on single / double element configuration).
- 9.2.1.7. Lift the heater cartridge out of the case without disconnecting the earth connection to the metal ring.
- 9.2.1.8. The new heater cartridge is then fitted into the metal ring and the heater cold leads reconnected.
- 9.2.1.9. On **(S)HM-200** product replace the base bracket. On the 2, 3 and 5 litre models replace the triangular base plate and refit the 3 screws.
- 9.2.1.10. Replace the earth lead and base and refasten using the previously removed plastic rivets.
- 9.2.1.11. The responsible body shall check the electrical safety of the product before further use.

### 9.3. Spillage and Decontamination.

#### Spillage:

In the event of spillage or glassware fracture, do not touch the mantle. Disconnect the product from the mains electrical supply. Allow the product to cool. Wearing suitable hand protection (giving due consideration to substances that were being heated) carefully remove any pieces of broken glassware. If decontamination is necessary, see section below. Otherwise wipe off all excess liquid from the mantle and surrounding area using an absorbent soft cloth. Drain of any residual fluid retained in the mantle. In the case of excessive spillage/ flask fracture, invert the mantle and allow it to drain for minimum of one hour. Then proceed with the following drying out procedure. Place the complete mantle, the correct way up, in a heated oven at 50 °C for a minimum period of 40 hours

**! Warning:** The equipment cannot be assumed to meet all the safety requirements of EN 61010-2-010: 2003 during the drying out process and until the drying out process is completed.

If in doubt please consult Customer Support. Refer to section 11.” NB: Replacement heater cartridges are obtainable from your Distributor/Manufacturer.



Before further use, the mantle must be subjected to electrical safety testing by competent service personnel.

If in doubt please consult Customer Support. Refer to section 11.



If the equipment has been exposed to contamination, the Responsible Body is responsible for carrying out appropriate decontamination. If hazardous material has been spilt on or inside the equipment, decontamination should only be undertaken under the control of the Responsible Body with due recognition of possible hazards. Before using any cleaning or decontamination method, the Responsible Body should check with the manufacturer the proposed method will not damage the equipment.

Prior to further use, the Responsible Body shall check the electrical safety of the unit. Only if all safety requirements are met can the unit be used again. The above procedure is intended as a guide. Should spillage occur with a toxic or hazardous fluid then special precautions may be necessary.

#### Decontamination Certificate.

**Note:** In the event of this equipment or any part of the unit becoming damaged, or requiring service, the item(s) should be returned to the manufacturer for repair accompanied by a decontamination certificate. **Copies of the Certificate are available from Distributor/Manufacturer.**

**At the end of life, this product must be accompanied by a Decontamination Certificate. See section 6.3 and 6.4**

## 10. PARTS AND ACCESSORIES

**10.1. Replacement Heater Cartridges.** All Cole-Parmer mantles are specified by the letters RE and Flask size. Add x1 suffix when ordering for 115V

**For all 220/240 volt product quote the Non x1 part number.**

| <b>Mantle model type</b> |       | <b>Replacement heater Cartridge.</b> |
|--------------------------|-------|--------------------------------------|
| HM-200-50                | Order | RE0050                               |
| HM-200-100               | Order | RE0100                               |
| HM-200-250               | Order | RE0250                               |
| HM-200-500               | Order | RE0500                               |
| HM-200-1000              | Order | RE1000                               |
| HM-200-2000              | Order | RE2000                               |
| HM-200-3000              | Oder  | RE3000                               |
| HM-200-5000              | Order | RE5000                               |
| SHM-200-50               | Order | REA0050                              |
| SHM-200-100              | Order | REA0100                              |
| SHM-200-250              | Order | REA0250                              |
| SHM-200-500              | Order | REA0500                              |
| SHM-200-1000             | Order | REA1000                              |
| SHM-200-2000             | Order | REA2000                              |
| HM-200-SP-1000           | Order | REMX1000                             |
| HM-200-SP-5000           | Order | REMX5000                             |
| HM-200-V-50              | Order | REMV0050                             |
| HM-200-V-250             | Order | REMV0250                             |
| HM-200-V-1000            | Order | REMV1000                             |
| HM-200-V-5000            | Order | REMV5000                             |

## 10.2. REPLACEABLE PARTS.

| <b>Order Number</b> | <b>Description.</b>                   | <b>Quantity</b> |
|---------------------|---------------------------------------|-----------------|
| AZ9021              | Spares Pack Simmerstat Controller     | 1               |
| AZ9034              | Fuse: F10A                            | 10              |
| AZ9035              | Fuse: F8A                             | 10              |
| AZ9036              | Fuse: F6.3A                           | 10              |
| AZ9038              | Fuse: F0.5A                           | 10              |
| AZ9040              | Fuse:F2.5A                            | 10              |
| AZ9041              | Fuse: F3.15A                          | 10              |
| AZ9130              | Fuse; F3A                             | 10              |
| CRM5607             | Neon: Clear (230V)                    | 1               |
| CRM5608             | Neon: Amber (230V)                    | 1               |
| CRM5619             | Neon: Clear (115V)                    | 1               |
| CRM5620             | Neon: Amber (115V)                    | 1               |
| CRM5621             | Switch, Element Selection (EMX, EMV). | 1               |
| 129320/3            | Support rod (710mm / 28 " long).      | 1               |
| 129320/4            | Support rod (1160mm / 45" long).      | 1               |
| 129320/5            | Support rod (1440mm / 55" long).      | 1               |
| 129320/6            | Support rod (590mm / 23" long).       | 1               |
| HH179(S)            | UK mains lead moulded plug            | 1               |
| HH180(S)            | European mains lead with plug         | 1               |
| CRM6288             | US moulded plug/lead set              | 1               |

## 11. CUSTOMER SUPPORT.

For help and support in using this product, please contact Customer Services at the following address.

**Antylia Scientific Ltd.**

Beacon Road,  
Stone,  
Staffordshire,  
ST15 0SA,  
United Kingdom  
Tel: +44 (0)1785 812121

General enquiries: [cpinfo@antylia.com](mailto:cpinfo@antylia.com)  
Order enquiries: [cpsales@antylia.com](mailto:cpsales@antylia.com)  
Technical support: [cptechsupport@antylia.com](mailto:cptechsupport@antylia.com)

[www.coleparmer.com](http://www.coleparmer.com)



## 12. NOTES.



This product meets the applicable CE Directives and UKCA Legislation for radio frequency interference and may be expected not to interfere with, or be affected by, other equipment with similar qualifications. We cannot be sure that other equipment used in its vicinity will meet these standards and so we cannot guarantee

that interference will not occur in practise. Where there is a possibility that injury, damage or loss might occur if equipment malfunctions due to radio frequency interference, or for general advise before use, contact the manufacturer.

Declaration of Conformity is available to view online at [www.coleparmer.com](http://www.coleparmer.com)

**EU Representative address**

Antylia Scientific GmbH  
Futtererstraße 16  
97877 Wertheim  
Deutschland  
Tel: +49 9377 9203-0  
Email: [sales@coleparmer.de](mailto:sales@coleparmer.de)

**UK Representative address**

Antylia Scientific  
9 Orion Court  
Ambuscade Road  
Colmworth Business Park  
St. Neots  
PE19 8YX  
United Kingdom  
Tel: +44 (0) 1480 277339  
Email: [enquiries@antylia.com](mailto:enquiries@antylia.com)

## Ordering Information

| Order No. | Series  | Model              | Legacy SKU    |
|-----------|---------|--------------------|---------------|
| 36002-02  | HM-200  | HM-200-50          | EM0050/CE     |
| 36002-00  | HM-200  | HM-200-50-115      | EM0050/CEX1   |
| 36002-06  | HM-200  | HM-200-100         | EM0100/CE     |
| 36002-04  | HM-200  | HM-200-100-115     | EM0100/CEX1   |
| 36002-10  | HM-200  | HM-200-250         | EM0250/CE     |
| 36002-08  | HM-200  | HM-200-250-115     | EM0250/CEX1   |
| 36002-14  | HM-200  | HM-200-500         | EM0500/CE     |
| 36002-12  | HM-200  | HM-200-500-115     | EM0500/CEX1   |
| 36002-18  | HM-200  | HM-200-1000        | EM1000/CE     |
| 36002-16  | HM-200  | HM-200-1000-115    | EM1000/CEX1   |
| 36002-22  | HM-200  | HM-200-2000        | EM2000/CE     |
| 36002-20  | HM-200  | HM-200-2000-115    | EM2000/CEX1   |
| 36002-26  | HM-200  | HM-200-3000        | EM3000/CE     |
| 36002-24  | HM-200  | HM-200-3000-115    | EM3000/CEX1   |
| 36002-30  | HM-200  | HM-200-5000        | EM5000/CE     |
| 36002-28  | HM-200  | HM-200-5000-115    | EM5000/CEX1   |
| 04641-05  | SHM-200 | SHM-200-50         | EMA0050/CEB   |
| 04641-00  | SHM-200 | SHM-200-50-115     | EMA0050/CEBX1 |
| 04641-15  | SHM-200 | SHM-200-100        | EMA0100/CEB   |
| 04641-10  | SHM-200 | SHM-200-100-115    | EMA0100/CEBX1 |
| 04641-25  | SHM-200 | SHM-200-250        | EMA0250/CEB   |
| 04641-20  | SHM-200 | SHM-200-250-115    | EMA0250/CEBX1 |
| 04641-35  | SHM-200 | SHM-200-500        | EMA0500/CEB   |
| 04641-30  | SHM-200 | SHM-200-500-115    | EMA0500/CEBX1 |
| 04641-45  | SHM-200 | SHM-200-1000       | EMA1000/CEB   |
| 04641-40  | SHM-200 | SHM-200-1000-115   | EMA1000/CEBX1 |
| 04641-55  | SHM-200 | SHM-200-2000       | EMA2000/CEB   |
| 04641-50  | SHM-200 | SHM-200-2000-115   | EMA2000/CEBX1 |
| 36104-05  | HM-200  | HM-200-V-50        | EMV0050/CE    |
| 36104-00  | HM-200  | HM-200-V-50-115    | EMV0050/CEX1  |
| 36104-15  | HM-200  | HM-200-V-250       | EMV0250/CE    |
| 36104-10  | HM-200  | HM-200-V-250-115   | EMV0250/CEX1  |
| 36104-25  | HM-200  | HM-200-V-1000      | EMV1000/CE    |
| 36104-20  | HM-200  | HM-200-V-1000-115  | EMV1000/CEX1  |
| 36104-35  | HM-200  | HM-200-V-5000      | EMV5000/CE    |
| 36104-30  | HM-200  | HM-200-V-5000-115  | EMV5000/CEX1  |
| 36101-05  | HM-200  | HM-200-SP-1000     | EMX1000/SCE   |
| 36101-00  | HM-200  | HM-200-SP-1000-115 | EMX1000/SCEX1 |
| 36101-15  | HM-200  | HM-200-SP-5000     | EMX5000/SCE   |
| 36101-10  | HM-200  | HM-200-SP-5000-115 | EMX5000/SCEX1 |

Warranty Registration



**Cole-Parmer®**  
essentials

**Antylia Scientific Ltd**  
Beacon Road, Stone,  
Staffordshire,  
ST15 0SA,  
United Kingdom

**UK**

T: +44 (0) 1480 272279  
E: uk.sales@antylia.com  
W: coleparmer.co.uk

**Germany**

T: +49 (0) 9377 92030  
E: de.sales@antylia.com  
W: coleparmer.de

**France**

T: +33 (0) 1486 37800  
E: fr.sales@antylia.com  
W: coleparmer.fr

**Italy**

T: +39 (0) 284349215  
E: it.sales@antylia.com  
W: coleparmer.it

**India**

T: +9122 61394444  
E: info@coleparmer.in  
W: coleparmer.in

**China**

T: +1 847 549 7600  
E: sales@antylia.com  
W: coleparmer.com

**USA**

T: +1 847 549 7600  
E: sales@antylia.com  
W: coleparmer.com

**Canada**

T: +514 355 6100  
E: info@antylia.ca  
W: coleparmer.ca

**Other**

T: +1 847 549 7600

