

Cole-Parmer®

HM-200 & SHM-200 Series

3 & 6 Position Mantles

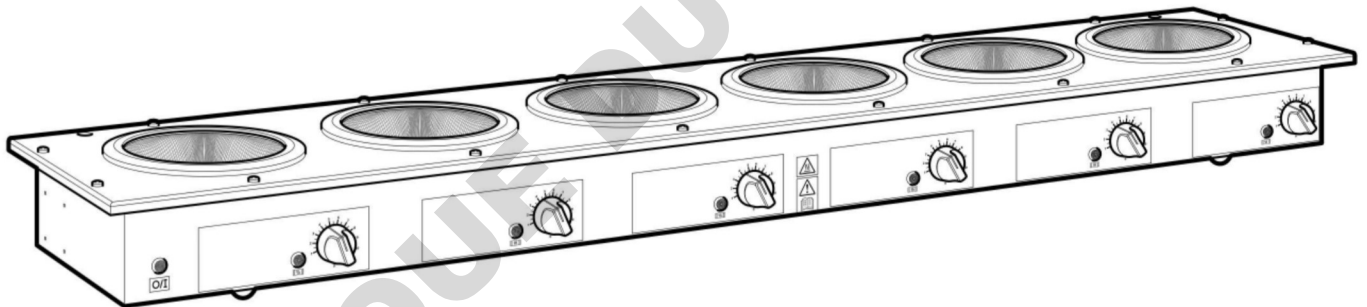

Instruction Manual

M8165 Version 2.5

Cole-Parmer®
essentials

Please take your time to read this Instructions book in order to understand the safe and correct use of your new Cole-Parmer product.

It is recommended the Responsible Body for use of this equipment reads this Instruction book and ensures the user(s) are suitably trained in its operation.

Contents.

Section 1.	Introduction.	Page 3
Section 2.	Symbols and using this Instruction Manual.	Page 4
Section 3.	Safety Information.	Page 5
Section 4.	Unpacking and Contents.	Page 7
Section 5.	Installation.	Page 9
Section 6.	Environmental Protection.	Page 10
Section 7.	Product Operation.	Page 11
Section 8.	Technical Specification.	Page 14
Section 9.	Maintenance.	Page 17
Section 10.	Parts and Accessories.	Page 20
Section 11.	Customer Support.	Page 21
Section 12.	Declaration of Conformity	Page 22

© The copyright of this instruction book is the property of Antylia Scientific Ltd. This instruction book is supplied by Antylia Scientific Ltd on the express understanding that it is to be used solely for the purpose for which it is supplied. It may not be copied, used or disclosed to others in whole or part for any

purpose except as authorised in writing by Antylia Scientific Ltd. Antylia Scientific Ltd reserves the right to alter, change or modify this document without prior notification.

In the interest of continued development Antylia Scientific Ltd. reserve the right to alter or modify the design and /or assembly process of their products without prior notification.

This product is manufactured in the United Kingdom by Antylia Scientific, part of Antylia Scientific Ltd.

Antylia Scientific Ltd.
Beacon Road,
Stone,
Staffordshire,
ST15 0SA,
United Kingdom
Tel: +44 (0)1785 812121

1. INTRODUCTION

- 1.1. The Cole-Parmer series of heating mantles has been specifically designed to provide a comprehensive answer to heating fluids in round bottomed glassware in the modern laboratory. It combines the traditional Cole-Parmer heating elements with many new features thus providing the user with several options to meet different applications.
- 1.2. Heating control is provided by a built-in solid state energy regulator.
- 1.3. The enclosures of the (S)HM-200-MP3 & (S)HM-200-MP6 are housed in aluminium cases with a paint finish to give good chemical resistance while the top cover is made from Polypropylene.
- 1.4. The products are provided with ventilation slots underneath and around the rim to ensure a low enclosure surface temperature. The heating element is retained in thermal Rockwool to create a heating cartridge that facilitates very easy replacement in the event of any damage. All Multi-Position Mantles are supplied with support rods and clamps (6 position only).
- 1.5. Antylia Scientific Ltd offers a comprehensive mantle range with the standard cool-to-touch vented case with element temperatures between ambient and 450 deg C.
- 1.6. Multi-Position Mantles are provided with the option of three or six recesses, built in solid-state energy controllers and choice of heater or heater/stirrer combinations. Capacities for flasks range from 100ml to 1000ml. All Extraction Mantles have individual energy regulator with indicator light for each heater cartridge position, allowing liquids with different boiling points to be heated alongside each other. The robust construction permits continuous operation of the units as required by routine extraction tests.















2. SYMBOLS AND USING THIS INSTRUCTION MANUAL

2.1. Throughout this instruction book the following symbols are shown to identify conditions which pose a hazard to the user, or to identify actions that should be observed. These symbols are also shown on the product, or its packaging. When a symbol is shown next to a paragraph or statement it is recommended the user takes particular note of that instruction in order to prevent damage to the equipment or to prevent injury to one's self or other people.

The Responsible Body and the Operator should read and be familiar with this Instruction book in order preserve the protection afforded by the equipment.

To prevent injury or equipment damage it is the manufacturer's recommendation that all persons using this equipment are suitably trained before use.

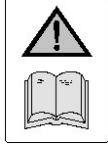
2.2. Symbols defined.

	Caution, risk of danger. See note or adjacent symbol.		This symbol adjacent to an indication lamp means mains power Off/On when lamp non-illuminated / illuminated.
	Protective conductor terminal to be earthed. (Do not loosen or disconnect).		This symbol adjacent to a switch denotes the Off condition for mains power.
	Caution / risk of electric shock.		This symbol adjacent to a switch denotes the ON condition for mains power.
	Recyclable Packing Material.		This symbol adjacent to a switch denotes the Off condition for the Heater or Stirrer.
	Do not dispose of product in normal domestic waste.		This symbol adjacent to a switch denotes the On condition for a Heater or Stirrer.
	Caution. Hot surface.		This symbol denotes stirrer speed control.
	Refer to instruction book.		Bio Chemical Hazard. Caution required. Will require decontamination.
			<i>Material irritant to skin. When handling wear face mask to BS/EN 149 and protective gloves.</i>

 **HOT ZONES, AVOID CONTACT**

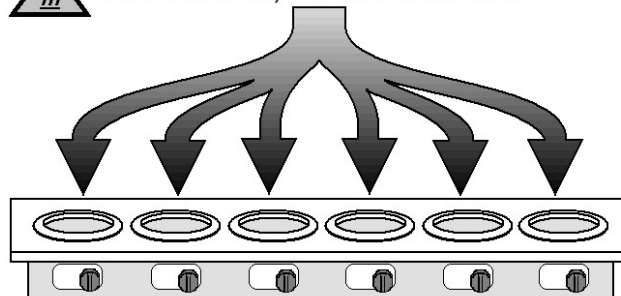

Hot Zone on 3 & 6 Way
HM-200, SHM-200
products

3. SAFETY INFORMATION

This product has been designed for safe operation when used as detailed in accordance with the manufacturer's instructions.

NOTE: Failure to use this equipment in accordance with the manufacturer's instruction book may compromise your basic safety protection afforded by the equipment and may invalidate the warranty / guarantee. The warranty / guarantee does not cover damage caused by faulty installation or misuse of the equipment

3.1. Prevention of Fire and Electric Shock.



To prevent a risk of fire or electric shock, **DO NOT** open your *product* case without authorisation. Only qualified Service personnel should attempt to repair this product.



Replace fuses only with the type as listed in section, 'Technical Specifications and Parts and Accessories' (See fuse type and rating).



Ensure the Mains Power Supply conforms to rating found on the data plate located on the back of this product.



Never operate this equipment without connection to earth / ground. Ensure the mains supply voltage is correctly earthed / grounded in accordance with current area legislation.

3.2. General Safe Operating Practice.



Always follow good laboratory practice when using this equipment. Give due recognition to your company's safety and legislative health & safety procedures and all associated legislation applicable to your areas of operation. Check laboratory procedures for substances being heated and ensure all hazards (e.g. explosion, implosion or the release of toxic or flammable gases) that might arise have been suitably addressed before proceeding. When heating certain substances the liberation of hazardous gases may require the use of a fume cupboard or other means of extraction.



Ensure equipment is used on a clean, dry, non-combustible, solid work surface with at least 300mm suitable clearance all around from other equipment.



Do not position the product so that it is difficult to disconnect from the mains supply.



Do not touch the heating element or any glass vessel whilst in use.



Do not lean or stretch over equipment, glassware and fixings when in use.



Do not immerse unit in water or fluids.



Do not spill substances onto the mantle. If spillage does occur, disconnect unit from mains supply and follow instructions as detailed in Maintenance. (Section 9).



Do not cover the mantle whilst in use. **Do not** block or obstruct ventilation slots / airways.



Do not leave equipment switched on without a charged flask(s).



Do not thermally insulate the exposed upper section of the vessel(s), as the insulation used may obstruct the convection cooling airways around the rim of the cartridge enclosure and cause the mantle to overheat.



It is not recommended to leave any heating apparatus unattended during operation.



Only use Original Equipment manufactures spares and accessories. Ref. Section 10.



Stirring versions of this equipment generate magnet fields. Keep all metal objects and magnetic data devices (e.g. credit cards) away from the stirrer unit.



The equipment is not spark, flame or explosion proof and has not been designed for use in hazardous areas in terms of BSEN 60079-14:1997. Keep flammable, low flash point substances away from the apparatus.



Do not operate or handle any part of the product with wet hands.



Keep the mains cord and moulded IEC plug and lead set away from the heating surface.



Warning statement - Unit will restart following a mains supply interruption

4. UNPACKING AND CONTENTS

4.1. Product Identification:

The model number allocated to each type of mantle is descriptive. The method of coding is detailed below.

Example

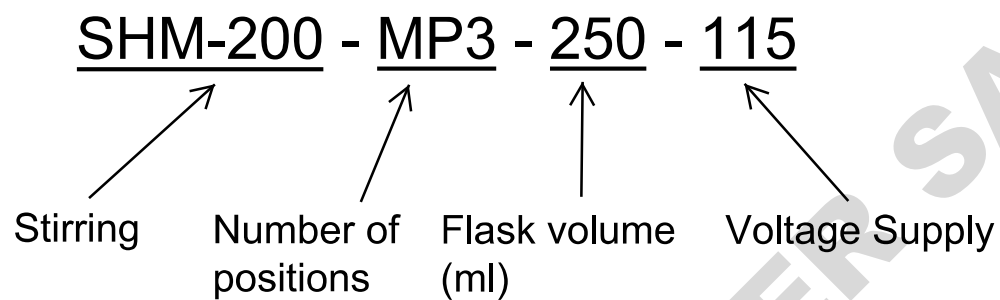

Note: Non-Stirring models are prefixed "HM-200"

Number of Positions: 3 or 6

Flask volume size: 100ml, 250ml, 500ml, 1000ml

Supply Voltage: Model numbers not suffixed "-115" = 230V a.c

Please check the contents of your carton against the relevant product diagram.
 Applicable to all HM-200 Multi-position products.

Item No	Description	Qty
1	HM-200 Multi-position product (6 way shown) .	1
2	Mains cord and moulded IEC plug and lead set. <i>(May differ from illustration depending on variant).</i>	A/R
3	Support rods set. (2 of one length and one of another) .	1
4	Stir bars (bag of 3 or 6) (SHM-200 Only) .	1
5	Instructions book	1
6	Support rod clamps (packet of 2 - 6 position only) .	1

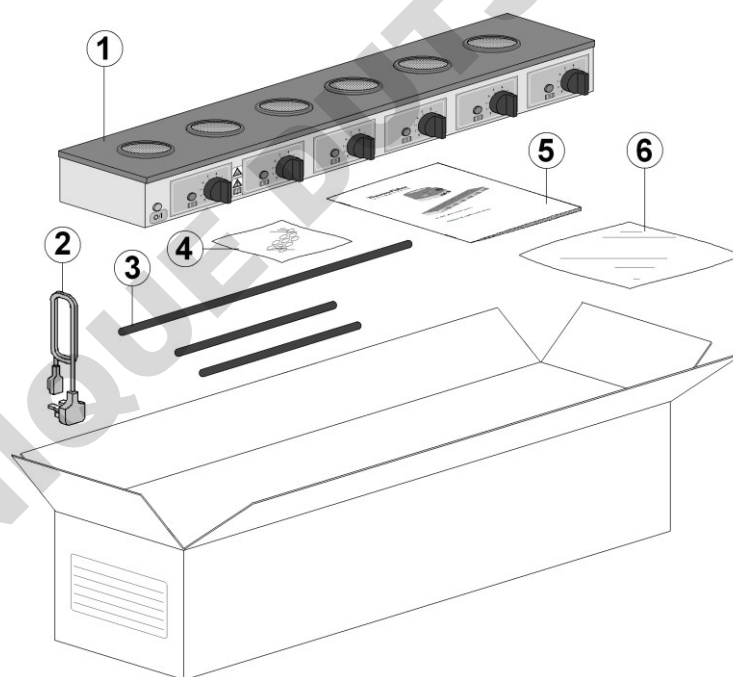

For future reference please record your products Serial and Model Numbers.	Serial Number	Unit Model/Cat Number

5. INSTALLATION

5.1. Electrical safety and installation.

5.1.1. This equipment is designed to be used safely under the following conditions:-



- Indoor use.
- Altitude up to 2000 meters.
- Temperatures between 5°C and 40°C.
- Maximum relative humidity 80% for temperatures up to 31°C decreasing linearly to 50% relative humidity at 40°C.
- Mains supply voltage fluctuations up to $\pm 10\%$ of the nominal voltage.
- Transient overvoltages typically present on the mains supply. Overvoltage category II.
- Applicable rated pollution degree 2.

5.1.2.  This equipment must be earthed / grounded to a fixed earth / grounded mains socket outlet. The mains supply is to earthed / grounded in accordance with current legislation. See Technical Specification for recommended fuse ratings.

5.1.3. Ensure only the correct rated mains input fuses are fitted. (Where applicable ensure the correct Mains cord and moulded IEC plug and lead set fuse if fitted). See technical information Section 8 of this instruction book.

5.1.4. Check the voltage on the product data label on this product unit and those of any accompanying electrical accessory. Ensure the rating conforms to your local supply.

5.1.5. This product should be connected to a mains supply source which incorporates a RCD or GFCI device that has a tripping current of 30mA or less. The RCD or GFCI Residual Current Device cuts off power to the equipment immediately it detects a current leakage fault. For example, cutting off the power when there is an accidental liquid spillage in a mantle protected with an earth (ground) screen.

5.1.6.   Do not install this product or accessories on a surface which may become flooded.

5.1.7. The unit is supplied with a Mains cord and moulded IEC plug and lead set wired as follows.

 Green / Yellow	or	Green	=	Earth / Ground
Blue	or	White	=	Neutral
Brown	or	Black	=	Live / line hot

5.2. **Observation:** the surface of the heating element of a mantle cartridge will upon receipt look slightly discoloured. This discolouration is normal and occurs at the factory during tests when the mantle is first heated up.

USA Notification.

Warning! Any modification or changes made to this device, unless explicitly approved by Antylia Scientific, will invalidate the authorisation of this device. Operation of an unauthorised device is prohibited under Section 302 of the Communications Act of 1934 as amended, and Subpart 1 of Part 2 of Chapter 47 of the code of Federal Regulations.

Note: This equipment has been tested and found to comply with the limits for a Class B digital device, pursuant to part 15 of the FCC Rules. These limits are designed to provide reasonable protection against harmful interference in a residential installation. This equipment generates, uses and can radiate radio frequency energy and, if not installed and used in accordance with the instructions, may cause harmful interference to radio communications. However, there is no guarantee that interference will not occur in a particular installation. If this equipment does cause harmful interference to radio or television reception, which can be determined by turning the equipment off and on, the user is encouraged to try to correct the interference by one or more of the following measures:

- Reorient or relocate the receiving antenna.
- Increase the separation between the equipment and receiver.
- Connect the equipment into an outlet on a circuit different from that to which the receiver is connected.
- Consult the dealer or an experienced radio/TV technician for help.

6. ENVIRONMENTAL PROTECTION

- 6.1. Maximum consideration has been given to environmental issues within the design and manufacturing process without compromising end product performance and value.



- 6.2. Packaging materials have been selected such that they may be sorted for recycling.



- 6.3. At the end of your product and accessories life, it must not be discarded as domestic waste. Ref: EU Directive 2002/96/EC on Waste Electrical and Electronic Equipment Directive (WEEE). Please contact your distributor / supplier for further information. For end users outside of the EU consult applicable regulations.

- 6.4. This product should only be dismantled for recycling by an authorised recycling company.





This product and accessories must be accompanied by a completed Decontamination Certificate prior to any disposal. Copies of the Certificate are available from Distributor/Manufacturer.

7. PRODUCT OPERATION

7.1. HM-200 3 and 6-way.

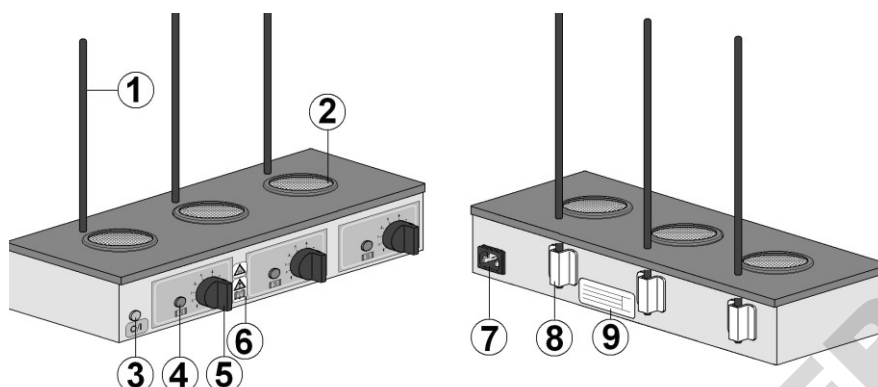
7.1.1. Overview of HM-200 Multi-position Mantle.



Item	Description.
1	Support Rods. (NB for 6 way units the support rod arrangement is as per SHM-200-MP6 (6 way)).
2	Heating Element 
3	Mains power on indicator
4	Heating element on
5	Energy regulator control knob
6	Warning Labels. (Hot surface and refer to this instruction book).
7	Mains input IEC socket (Contains protective fuses).
8	Rod support brackets
9	Data Plate

7.1.2. Fasten the rod supports provided into the mantle's rod support location bracket via the top cover holes.

7.1.3. With the mains supply electricity switched off, connect the mains cord and moulded IEC plug and lead set to the mains IEC socket.

7.1.4. Place a charged, clean, dry glass vessel of the size indicated on the mantle data plate label in the positions intended for use. Wherever possible the glass vessel should be supported within the mantle by means of the support rod and clamp.

7.1.5. Switch on the mains electrical supply. Adjust the controller regulator knob in each position to the required setting.

NOTE: The mains power on indication neon will illuminate. The amber heating on neon will be illuminated in each position and pulsate (depending on setting) when the heaters are in operation.

7.1.6. When the process is complete switch the regulator knobs to their off positions. Disconnect the mains electricity supply.

7.1.7.   Remove charged vessels. Handle hot charged vessel with care.

7.2. SHM-200 Multi-position 3 and 6-way.

7.2.1. Overview of SHM-200 Multi-position Mantle.

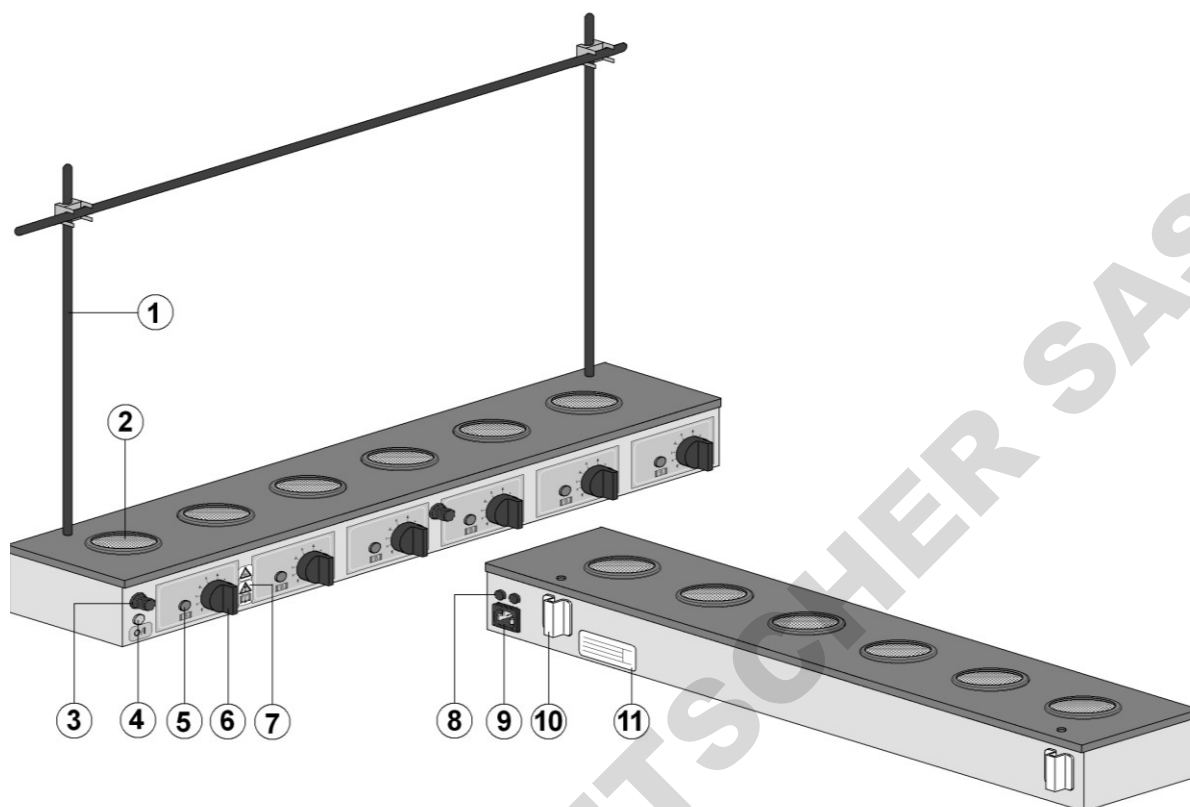

7.2.2. Switch on the mains electrical supply. Adjust the controller regulator knob in each position to the required setting.

NOTE: The mains power on indication neon will illuminate. The amber heating on neon will be illuminated in each position when the heaters are in operation.

Item	Description.
1	Support Rods and clamps (NB for 3 way units the support rod arrangement is as per HM-200-MP3 (3 way).)
2	Heating Element 
3	Stir speed regulation
4	Mains power on indicator
5	Heating element on
6	Energy regulator control knob
7	Warning Labels. (Hot surface and refer to instruction book.)
8	Fuse holders (Contains protective fuses.)
9	Mains input IEC socket
10	Rod support brackets
11	Data Plate

- 7.2.3. Fasten the rod supports provided into the mantle's rod support location bracket via the top cover holes and fit the cross bar using the clamps supplied.
- 7.2.4. With the mains supply electricity switched off, connect the mains cord and moulded IEC plug and leads set to the mains IEC socket.

7.2.5. Carefully place the stir bars provided into each vessel and turn the rotational speed controls to the OFF (O – setting).

7.2.6. Place a charged, clean, dry glass vessel of the size indicated on the mantle data plate label containing the stirrer bars in the positions intended for use. Wherever possible the glass vessel should be supported within the mantle by means of the support rod and clamp.

7.2.7. Switch on the mains electrical supply. Adjust the controller regulator knob in each position to the required setting.

NOTE: The mains power on indication neon will illuminate. The amber heating on neon will be illuminated (and pulsate dependent on setting) in each position when the heaters are in operation.

7.2.8. A single stirring module controls the stirring on the EMEA3. Two separate stirrer modules and two controllers are used on the EMEA6. Each controller controls the stir function on the three mantle positions immediately to the right of the respective control position.

Uni-directional stirring up to 1000 RPM.

7.2.9. Switch the stir facility on. The neon will illuminate.

7.2.10. Adjust the rotational speed by means of the speed control knob. Should the stirring action be lost by over rotation, then reduce the stir speed to minimum, wait for the stir bar to come to rest and slowly re-increase the stir speed once more.

7.2.11. When the process is complete switch the regulator knobs to their off positions. Disconnect the mains electricity supply.

7.2.12.   Remove charged vessels. Handle hot charged vessel with care.

8. TECHNICAL SPECIFICATION

8.1. Specifications EME range (General).

Mains input supply voltage (115V – AC).	115V – AC ± 10% at 50/60Hz.
Mains input supply voltage (230V – AC).	230V – AC ± 10% at 50/60Hz.
Fuse type (HM-200-MP3, SHM-200-MP3).	See table below for fuse type.
Fuse type (HM-200-MP6, SHM-200-MP6).	See table below for fuse type.
Operational climatic conditions. Heating Element Construction.	Temperature range 5°C to 40°C. Humidity no to exceed 80%. Thermal insulated element wire stitched into a cartridge construction.
Maximum Element temperature.	450°C. Nominal Max.
Case construction.	Polypropylene and coated aluminium.
Thermal Insulation.	Mineral Wool.
Clamps for support rods.	½” (12.7mm) dia. max.
Mains cord and moulded IEC plug and lead set cable (UK) 10A BS1363/A.	3 core earthed / ground. 2 meters long Moulded IEC plug and Lead set – supply cord H05 V VF- Replace only with equivalent cable.
Mains cord and moulded IEC plug and lead set cable (Europe).	3 core earthed / ground. 2 meters long Moulded IEC plug and Lead set – supply cord H05 V VF- Replace only with equivalent cable.
Mains cord and moulded IEC plug and lead set cable (USA).	3 core earthed / ground. 2 meters long Moulded IEC plug and Lead set – supply cord SJT VW 1- Replace only with equivalent cable.

8.1.1. Power consumption and fuse rating.

230V Models			
Product	Size	Total Heating Power	Fuse Rating and Type
HM-200-MP3-100	3 x 100ml	3 x 60	F3.15A 6.35 x 32 Ceramic
SHM-200-MP3-100	3 x 100ml	3 x 60 + 40 (stir)	F3.15A 6.35 x 32 Ceramic
HM-200-MP3-250	3 x 250ml	3 x 150	F3.15A 6.35 x 32 Ceramic
SHM-200-MP3-250	3 x 250ml	3 x 150 + 40 (stir)	F3.15A 6.35 x 32 Ceramic
HM-200-MP3-500	3 x 500ml	3 x 200	F3.15A 6.35 x 32 Ceramic
SHM-200-MP3-500	3 x 500ml	3 x 200 + 40 (stir)	F6.3A 6.35 x 32 Ceramic
HM-200-MP3-1000	3 x 1000ml	3 x 300	F5A 6.35 x 32 Ceramic
SHM-200-MP3-1000	3 x 1000ml	3 x 300 + 40 (stir)	F6.3A 6.35 x 32 Ceramic
HM-200-MP6-100	6 x 100ml	6 x 60	F3.15A 5 x 20 Glass Quick Blow
SHM-200-MP6-100	6 x 100ml	6 x 60 + 80 (stir)	F3.15A 5 x 20 Glass Quick Blow
HM-200-MP6-250	6 x 250ml	6 x 150	F5A 5 x 20 Glass Quick Blow
SHM-200-MP6-250	6 x 250ml	6 x 150 + 80 (stir)	F6.3A 5 x 20 Glass Quick Blow
HM-200-MP6-500	6 x 500ml	6 x 200	F6.3A 5 x 20 Glass Quick Blow
SHM-200-MP6-500	6 x 500ml	6 x 200 + 80 (stir)	F6.3A 5 x 20 Glass Quick Blow
HM-200-MP6-1000	6 x 1000ml	6 x 300	F10A 5 x 20 Glass Quick Blow
SHM-200-MP6-1000	6 x 1000ml	6 x 300 + 80 (stir)	F10A 5 x 20 Glass Quick Blow

115V Models			
Product	Size	Total Heating Power	Fuse Rating and Type
HM-200-MP3-100-115	3 x 100ml	3 x 72	F3.15A 6.35 x 32 Ceramic
SHM-200-MP3-100-115	3 x 100ml	3 x 72 + 40 (stir)	F3.15A 6.35 x 32 Ceramic
HM-200-MP3-250-115	3 x 250ml	3 x 150	F8A 6.35 x 32 Ceramic
SHM-200-MP3-250-115	3 x 250ml	3 x 150 + 40 (stir)	F8A 6.35 x 32 Ceramic
HM-200-MP3-500-115	3 x 500ml	3 x 200	F8A 6.35 x 32 Ceramic
SHM-200-MP3-500-115	3 x 500ml	3 x 200 + 40 (stir)	F8A 6.35 x 32 Ceramic
HM-200-MP3-1000-115	3 x 1000ml	3 x 300	F10A 6.35 x 32 Ceramic
SHM-200-MP3-1000-115	3 x 1000ml	3 x 300 + 40 (stir)	F10A 6.35 x 32 Ceramic
HM-200-MP6-100-115	6 x 100ml	6 x 72	F5A 5 x 20 Glass Quick Blow
SHM-200-MP6-100-115	6 x 100ml	6 x 72 + 80 (stir)	F6.3A 5 x 20 Glass Quick Blow
HM-200-MP6-250-115	6 x 250ml	6 x 150	F10A 5 x 20 Glass Quick Blow
SHM-200-MP6-250-115	6 x 250ml	6 x 150 + 80 (stir)	F10A 5 x 20 Glass Quick Blow
HM-200-MP6-500-115	6 x 500ml	6 x 200	F15A 6.35 x 32 Glass Quick Blow
SHM-200-MP6-500-115	6 x 500ml	6 x 200 + 80 (stir)	F15A 6.35 x 32 Glass Quick Blow
HM-200-MP6-1000-115	6 x 1000ml	6 x 300	F10A 6.35 x 32 Ceramic
SHM-200-MP6-1000-115	6 x 1000ml	6 x 300 + 80 (stir)	F10A 6.35 x 32 Ceramic

8.1.2. The Ingress protection rating for the EM product range is IPX0.

8.1.3. Dimensions and weight (unpacked).

**HM-200-MP3-100 / SHM-200-MP3-100 -
100ml x3 Weight 6.2kg / 7.0kg**

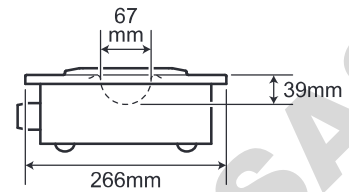
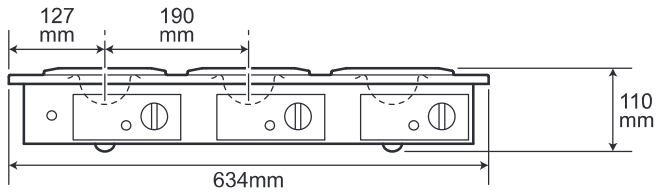

**HM-200-MP3-250 / SHM-200-MP3-250 -
250ml x3 Weight 6.2kg / 7.0kg**

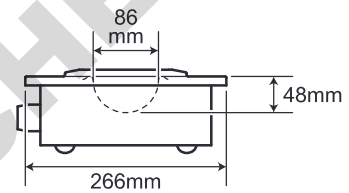
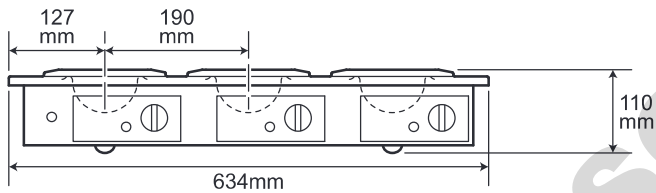

**HM-200-MP3-500 / SHM-200-MP3-500 -
500ml x3 Weight 7.4kg / 8.4kg**

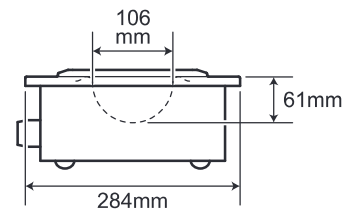
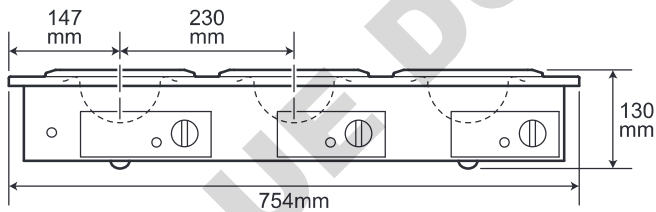

**HM-200-MP3-1000 / SHM-200-MP3-1000 -
1000ml x3 Weight 7.4kg / 8.4kg**

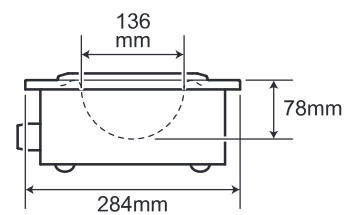
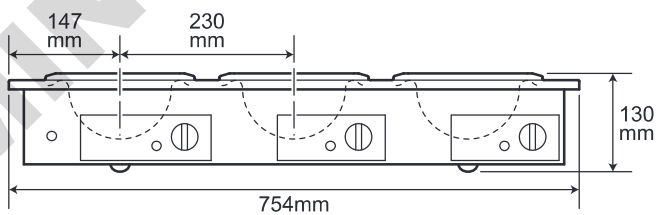

**HM-200-MP6-100 / SHM-200-MP6-100 -
100ml x6 Weight 10.1kg / 12.5kg**

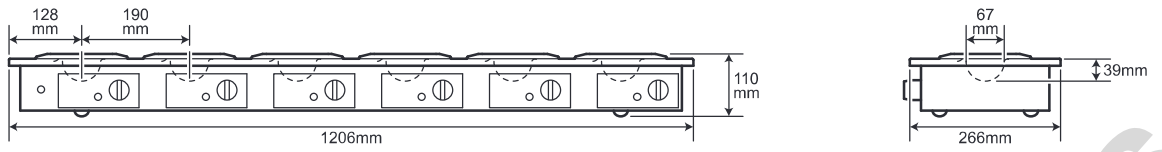

**HM-200-MP6-250 / SHM-200-MP6-250 -
250ml x6 Weight 10.1kg / 12.5kg**

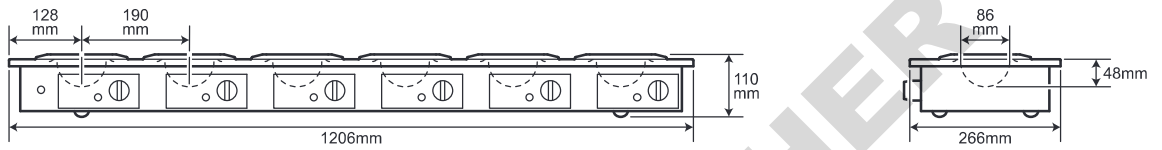

**HM-200-MP6-500 / SHM-200-MP6-500 -
500ml x6 Weight 10.1kg / 12.5kg**

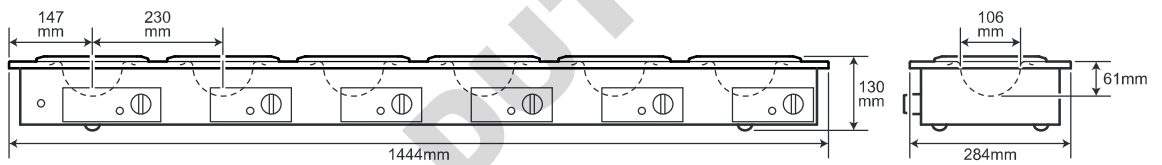

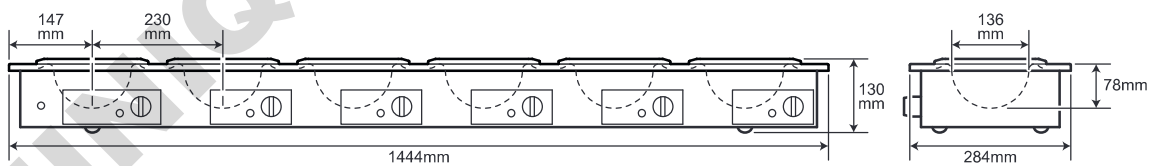

**HM-200-MP6-1000 / SHM-200-MP6-1000 -
1000ml x6 Weight 10.1kg / 12.5kg**



9. MAINTENANCE

9.1. General Information.

  Unplug the unit from the mains voltage supply and allow it to cool before undertaking any maintenance tasks.

 Maintenance should only be carried out under the direction of the Responsible Body, by a competent electrician. Failure to do so may result in damage to the product and in extreme cases be a danger to the end user.

With proper care in operation this equipment has been designed to give many years of reliable service. Contamination or general misuse will reduce the effective life of this product and may cause a hazard.

Maintenance for the unit should include:

- Periodic electrical safety testing (an annual test is recommended as the minimum requirement).
- Regular inspection for damage with particular attention to the mains lead and plug set.
- Routine cleaning of the equipment should be undertaken using a clean cloth.

DO NOT USE SOLVENTS FOR CLEANING ANY PART OF THIS EQUIPMENT.

9.2. Fuse Replacement.

The mains fuse holder is located at the rear of your product. Refer to Technical Specification (section 8) for correct fuse type and rating. Turn your product off and disconnect it from the mains supply.

- ① Unscrew both fuse holder caps from the fuse housings.
- ② Remove the fuses. Fit replacement fuses of the correct type and rating.

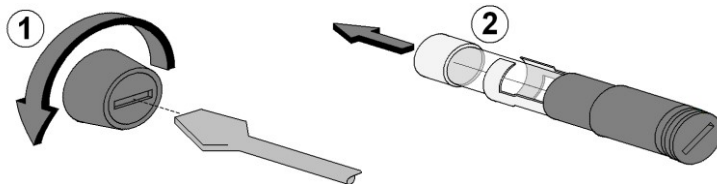

9.3. Heater Cartridge replacement.



IRRITANT

HM-200 and SHM-200 mantles contain Rockwool mineral insulation. When handling a suitable face mask which bears the CE mark should be used. A face mask to BS/EN 149 is adequate. When handling, wear gloves. Should skin irritation be experienced it can be lessened by rinsing hands under cold running water before washing. For further information refer to guidance note EH46 published by HMSO and technical data sheets available from Rockwool Limited., Pencoed, Bridgend, CF35 6NY.

In the event of a heater element becoming damaged or an open circuit the following procedure should be adopted for its replacement:

- 9.3.1. Unplug or disconnect the mantle from the mains electricity supply.
- 9.3.2. Remove the cross-head fixing screws from the lid and lift the lid off.
- 9.3.3. Disconnect the lid from the base earth wire.
- 9.3.4. Remove the three M3 cartridge retention nuts and disconnect the cold leads from the temperature controller PCB.
- 9.3.5. Reverse this process to fit the new cartridge assembly. On SHM-200 product ensure the cold leads do not obstruct the stir belt.
- 9.3.6. Replace the earth lead and base and refasten using the previously removed cross-head fixing screws.
- 9.3.7. The responsible body shall check the electrical safety of the product before further use.

9.4. Spillage and Decontamination.

Spillage:

In the event of spillage or glassware fracture, do not touch the mantle. Disconnect the product from the mains electrical supply. Allow the product to cool. Wearing suitable hand protection (giving due consideration to substances that were being heated) carefully remove any pieces of broken glassware. If decontamination is necessary, see section below. Otherwise wipe off all excess liquid from the mantle and surrounding area using an absorbent soft cloth. Drain of any residual fluid retained in the mantle. In the case of excessive spillage/ flask fracture, invert the mantle and allow it to drain for minimum of one hour. Then proceed with the following drying out procedure. Place the complete mantle, the correct way up, in a heated oven at 50°C for a minimum period of 40 hours.

! Warning !: The equipment cannot be assumed to meet all the safety requirements of EN 61010-2-010 during the drying out process and until the drying out process is completed.

If in doubt please consult customer support. Refer to section 12. NB: Replacement heater cartridges are obtainable from your Distributor/Manufacturer.



Before further use, the mantle must be subjected to electrical safety testing by competent service personnel.

If in doubt please consult customer support. Refer to section 11.



If the equipment has been exposed to contamination, the Responsible Body is responsible for carrying out appropriate decontamination. If hazardous material has been spilt on or inside the equipment, decontamination should only be undertaken under the control of the Responsible Body with due recognition of possible hazards. Before using any cleaning or decontamination method, the Responsible Body should check with the manufacturer the proposed method will not damage the equipment.

Prior to further use, the Responsible Body shall check the electrical safety of the unit. Only if all safety requirements are met can the unit be used again. The above procedure is intended as a guide. Should spillage occur with a toxic or hazardous fluid then special precautions may be necessary.

Decontamination Certificate.

Note: In the event of this equipment or any part of the unit becoming damaged, or requiring service, the item(s) should be returned to the manufacturer for repair accompanied by a decontamination certificate. **Copies of the Certificate are available from Distributor/Manufacturer.**

At the end of life, this product must be accompanied by a Decontamination Certificate. See section 6.3 and 6.4.

10. PARTS AND ACCESSORIES

10.1. Replacement Heater Cartridges. All Cole-Parmer mantles are specified by the letters RE and Flask size. Add X1 suffix when ordering for 115V

Mantle model type			Replacement heater Cartridge.	
HM-100	(3 & 6 way)	Order	REME0100	
HM-250	(3 & 6 way)	Order	REME0250	
HM-500	(3 & 6 way)	Order	REME0500	
HM-1000	(3 & 6 way)	Order	REME1000	
SHM-100	(3 & 6 way)	Order	REMEA0100	
SHM-250	(3 & 6 way)	Order	REMEA0250	
SHM-500	(3 & 6 way)	Order	REMEA0500	
SHM-1000	(3 & 6 way)	Order	REMEA1000	

10.2. Replaceable Parts.

Order Number	Description.	Quantity
HH179(S)	Mains cord and moulded IEC plug and lead set (UK) 230V – 10A BS1363/A	1
HH180(S)	Mains cord and moulded IEC plug and lead set (Europe) 230V	1
CRM6288	Mains cord and moulded IEC plug and lead set (USA) 115V	1
AZ9021	Solid state Simmerstat assembly (90-250V - AC).	1
M5607	Neon: Clear (230V)	1
M5608	Neon: Amber (230V)	1
M5619	Neon: Clear (115V)	1
M5620	Neon: Amber (115V)	1
129320/3	Support rod (710mm / 28" long).	1
129320/4	Support rod (1160mm / 45" long).	1
129320/5	Support rod (1440mm / 55" long).	1
129320/6	Support rod (590mm / 23" long).	1

Replacement fuses can be ordered by contacting cpspares@antylia.com. Please refer to Technical Specification (section 8) for correct fuse type and rating.

11. CUSTOMER SUPPORT.

For help and support in using this product, please contact Customer Services at the following address.

Antylia Scientific Ltd.
Beacon Road,
Stone,
Staffordshire,
ST15 0SA,
United Kingdom
Tel: +44 (0)1785 812121

General enquiries: cpinfo@antylia.com
Order enquiries: cpsales@antylia.com
Technical support: cptechsupport@antylia.com

www.coleparmer.com

DOMINIQUE DUTSCHER SAS



This product meets the applicable CE Directives and UKCA Legislation for radio frequency interference and may be expected not to interfere with, or be affected by, other equipment with similar qualifications. We cannot be sure that other equipment used in its vicinity will meet these standards and so we cannot guarantee

that interference will not occur in practise. Where there is a possibility that injury, damage or loss might occur if equipment malfunctions due to radio frequency interference, or for general advise before use, contact the manufacturer.

Declaration of Conformity is available to view online at www.coleparmer.com

DOMINIQUE DUTSCHER SAS

EU Representative address

Antylia Scientific GmbH
Futtererstraße 16
97877 Wertheim
Deutschland
Tel: +49 9377 9203-0
Email: sales@coleparmer.de

UK Representative address

Antylia Scientific
9 Orion Court
Ambuscade Road
Colmworth Business Park
St. Neots
PE19 8YX
United Kingdom
Tel: +44 (0) 1480 277339
Email: enquiries@antylia.com

Ordering Information

Order No.	Series	Model	Legacy SKU
03076-01	HM-200	HM-200-MP3-100	EME30100/CEB
03076-00	HM-200	HM-200-MP3-100-115	EME30100/CEBX1
03076-04	HM-200	HM-200-MP3-250	EME30250/CEB
03076-03	HM-200	HM-200-MP3-250-115	EME30250/CEBX1
03076-07	HM-200	HM-200-MP3-500	EME30500/CEB
03076-06	HM-200	HM-200-MP3-500-115	EME30500/CEBX1
03076-10	HM-200	HM-200-MP3-1000	EME31000/CEB
03076-09	HM-200	HM-200-MP3-1000-115	EME31000/CEBX1
03076-25	HM-200	HM-200-MP6-100	EME60100/CEB
03076-24	HM-200	HM-200-MP6-100-115	EME60100/CEBX1
03076-28	HM-200	HM-200-MP6-250	EME60250/CEB
03076-27	HM-200	HM-200-MP6-250-115	EME60250/CEBX1
03076-31	HM-200	HM-200-MP6-500	EME60500/CEB
03076-30	HM-200	HM-200-MP6-500-115	EME60500/CEBX1
03076-34	HM-200	HM-200-MP6-1000	EME61000/CEB
03076-33	HM-200	HM-200-MP6-1000-115	EME61000/CEBX1
03076-13	SHM-200	SHM-200-MP3-100	EMEA30100/CE
03076-12	SHM-200	SHM-200-MP3-100-115	EMEA30100/CEX1
03076-16	SHM-200	SHM-200-MP3-250	EMEA30250/CE
03076-15	SHM-200	SHM-200-MP3-250-115	EMEA30250/CEX1
03076-19	SHM-200	SHM-200-MP3-500	EMEA30500/CE
03076-18	SHM-200	SHM-200-MP3-500-115	EMEA30500/CEX1
03076-22	SHM-200	SHM-200-MP3-1000	EMEA31000/CE
03076-21	SHM-200	SHM-200-MP3-1000-115	EMEA31000/CEX1
03076-37	SHM-200	SHM-200-MP6-100	EMEA60100/CE
03076-36	SHM-200	SHM-200-MP6-100-115	EMEA60100/CEX1
03076-40	SHM-200	SHM-200-MP6-250	EMEA60250/CE
03076-39	SHM-200	SHM-200-MP6-250-115	EMEA60250/CEX1
03076-43	SHM-200	SHM-200-MP6-500	EMEA60500/CE
03076-42	SHM-200	SHM-200-MP6-500-115	EMEA60500/CEX1
03076-46	SHM-200	SHM-200-MP6-1000	EMEA61000/CE
03076-45	SHM-200	SHM-200-MP6-1000-115	EMEA61000/CEX1

Warranty Registration



Cole-Parmer®
essentials

Antylia Scientific Ltd
Beacon Road,
Stone,
Staffordshire,
ST15 0SA,
United Kingdom

UK

T: +44 (0) 1480 272279
E: uk.sales@antylia.com
W: coleparmer.co.uk

Germany

T: +49 (0) 9377 92030
E: de.sales@antylia.com
W: coleparmer.de

France

T: +33 (0) 1486 37800
E: fr.sales@antylia.com
W: coleparmer.fr

Italy

T: +39 (0) 284349215
E: it.sales@antylia.com
W: coleparmer.it

India

T: +9122 61394444
E: info@coleparmer.in
W: coleparmer.in

China

T: +1 847 549 7600
E: sales@antylia.com
W: coleparmer.com

USA

T: +1 847 549 7600
E: sales@antylia.com
W: coleparmer.com

Canada

T: +514 355 6100
E: info@antylia.ca
W: coleparmer.ca

Other

T: +1 847 549 7600



DOMINIQUE DUTSCHER SAS