

Cole-Parmer[®]

HM-200 & SHM-200 Series

Heating Mantles

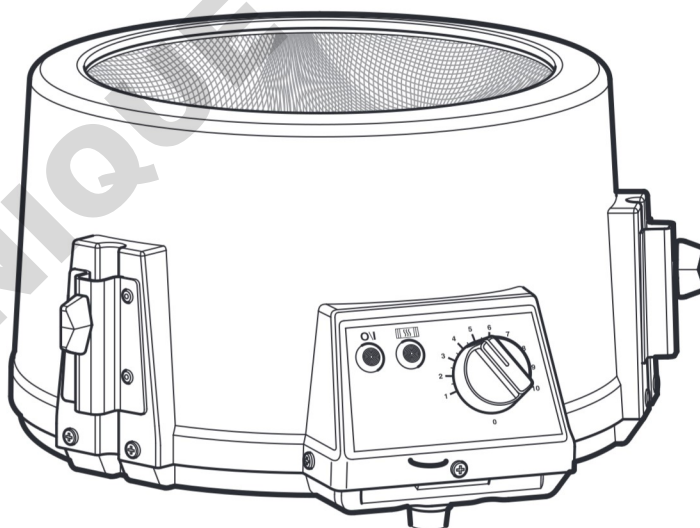
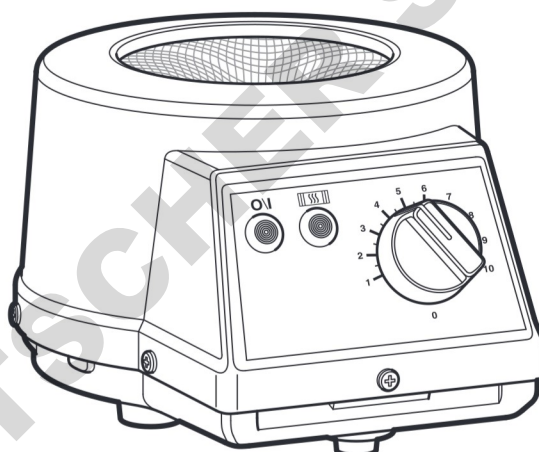
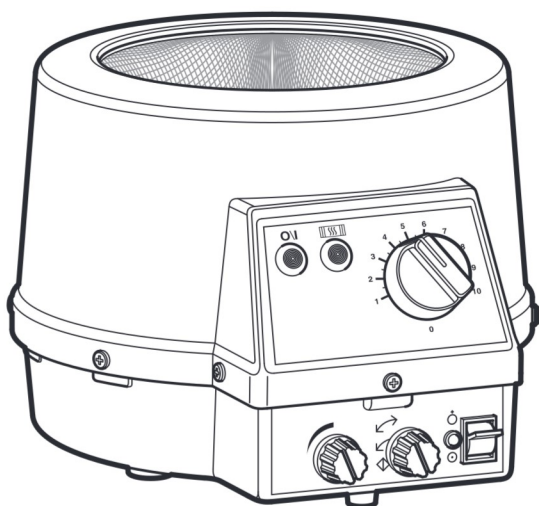

Instruction Manual
M6873 Version 12.9

Cole-Parmer[®]
essentials

Please take your time to read this Instruction Manual in order to understand the safe and correct use of your new Cole-Parmer product.

It is recommended the Responsible Body for use of this equipment reads this Instruction Manual and ensures the user(s) are suitably trained in its operation.

Contents.

Section 1.	Introduction.	Page 3
Section 2.	Symbols and using this Instructions Manual.	Page 4
Section 3.	Safety Information.	Page 5
Section 4.	Unpack and Contents.	Page 7
Section 5.	Installation.	Page 9
Section 6.	Environmental Protection.	Page 10
Section 7.	Product Operation.	Page 11
Section 8.	Technical Specification.	Page 14
Section 9.	Maintenance.	Page 19
Section 10.	Replaceable Parts and Accessories.	Page 22
Section 11.	Customer Support.	Page 24
Section 12.	Notes.	Page 25
Section 13.	Declaration of Conformity.	Page 26

© The copyright of this instruction manual is the property of Antylia Scientific Ltd. This instruction manual is supplied by Antylia Scientific Ltd on the express understanding that it is to be used solely for the purpose for which it is supplied. It may not be copied, used or disclosed to others in whole or part for any purpose except as authorised in writing by Antylia Scientific Ltd. Antylia Scientific Ltd. reserves the right to alter, change or modify this document without prior notification.

In the interest of continued development Antylia Scientific Ltd. reserve the right to alter or modify the design and /or assembly process of their products without prior notification.

This product is manufactured in the United Kingdom by Antylia Scientific, part of Antylia Scientific Ltd.

Antylia Scientific Ltd.
Beacon Road,
Stone,
Staffordshire,
ST15 0SA,
United Kingdom
Tel: +44 (0)1785 812121

I. INTRODUCTION.

6JG %QNG 2CTOGT UGTIGU QH JGCVPI OCPVIGU JCU DGGP URGEKHECNI FGUKIPGF VQ
RTQXIFG C EQORTGJGPKXG CPUYGT VQ JGCVPI HMKFU KP TQWPF DQWQOGF INCUUYCTG KP
VJG OQFGTP NCDQTCVQT[+V EQODKPGU VJG VTCFKKQPCN %QNG 2CTOGT JGCVPI GNGOGPV YKJ
OCP[PGY HGCWWTGU VJWU RTQXIFKPI VJG WUGT YKJ UGXGTGN QRKQPU VQ OGGV FKHHGTGPV
CRRWECVQPU

*GCVPI EQPVTQN KU RTQXIFGF D[C DWNV KP UQWF UVCVG GPGTI [TGIWNCVQT OQP UVKTKPI
OCPVIGU ECP DG WUGF YKJ CP GZVGTPCN EQPVTQNGT 2NGCUG EQPVCEV FKUVTKDWWQT
OCPWHCEWWTGT HQT FGVCNU

6JG GPEINQUWTGU QH the HM-200, SHM-200, HM-200-V and HM-200-SP KPFKXKFWCN JGCVPI
OCPVIGU CTG OCPWHCEWWTGF HTQO EJGOECN TGUKUVCPV 2QNI[RTQR[NGPG

6JG RTQFWEVU CTG RTQXIFGF YKJ XGPVKNVQKQ UNQVU WPFGTGCVJ CPF CTQWPF VJG TKO VQ
GPUWTG C IQY GPEINQUWTG UWTHCEG VGORGTGWTG 6JG JGCVPI GNGOGPV KU TGVCXPGF KP
VJGTQCN 4QEMYQQN VQ ETGCVG C JGCVPI ECTVTKF IG VJCV HCEKNCVIGU XGT[GCU[TGRICEGOGPV
KP VJG GXGPV QH CP[FCOCIG On dN UK\GU WR VQ NVTG, C UKPING UWRRQTV EICOR KU
RTQXIFGF CV VJG TGCT QH VJG WPKV 1P VJG CPF NVTG OQFGNU VJGTG CTG VJTG TQF
UWRRQTV EICORU 6JG HM-200-V CPF HM-200-SP range JCXG C JQNG KP VJG DCUG VQ
GPCDNG HWPPGNIU QT DQWQO QWVIGV HNCUMU VQ DG JGCVGF #N models CTG UWRRKGF YKJ
UWRRQTV TQFU CPF EICORU

Antylia Scientific QHGTU C EQORTGJGPKXG TCPIG QH / CPVIGU CPF %QPVTQNGTU 6JG
/ CPVIGU TCPIG HTQO VJG 5VCPFCF EQQN VQ VQWEJ XGPVGF ECUG YKJ GNGOGPV
VGORGTGWTGU DG VYGGP CODKGPV CPF FGI % 6JG 5VCPFCF Individual HM-200
/ CPVIG range JCU configurations 5RKN 2TQQH (HM-200-SP) 8 5JCRGF (HM-200-V)
and *GCVPI CPF 5VTKTKPI (SHM-200 range) YKJ UKPING QT DK FKTGEVQPCN UVKTKPI
QRKQPU %CRCEKNGU HQT TQWPF DQWQOGF INCUUYCTG TCPIKPI HTQO ON WR VQ ON
RNUU HWPPGNI QRKQPU 4GRICEGOGPV JGCVGT ECTVTKF IGU CTG CXCMCDNG

2. SYMBOLS AND USING THIS INSTRUCTION MANUAL.

2.1. Throughout this Instruction Manual the following symbols are shown to identify conditions which pose a hazard to the user, or to identify actions that should be observed. These symbols are also shown on the product, or its packaging. When a symbol is shown next to a paragraph or statement it is recommended the user takes particular note of that instruction in order to prevent damage to the equipment or to prevent injury to one's self or other people.

The Responsible Body and the Operator should read and be familiar with this Instruction Manual in order to preserve the protection afforded by the equipment.

To prevent injury or equipment damage it is the manufacturers recommendation that all persons using this equipment are suitably trained before use.

2.2. Symbols defined.



Caution, risk of danger. See note or adjacent symbol.



Protective conductor terminal to be earthed.
(Do not loosen or disconnect).



Caution / risk of electric shock



Recyclable Packing Material.



Do not dispose of product in normal domestic waste.



Caution. Hot surface.



Refer to Instruction Manual.



This symbol denotes stirrer speed control.



This symbol adjacent to the stirrer switch denotes the bi-directional stir condition with auto-reverse.



Material irritant to skin. When handling wear face mask to BS/EN 149 and protective gloves



This symbol adjacent to an indication lamp means mains power Off/On when lamp non-illuminated / illuminated



This symbol adjacent to a switch denotes the Off condition for mains power.



This symbol adjacent to a switch denotes the ON condition for mains power.



This symbol adjacent to a switch denotes the Off condition for the Heater or Stirrer.



This symbol adjacent to a switch denotes the On condition for a Heater or Stirrer.



This symbol indicates an output terminal for the equipment.



This symbol indicates an input terminal for the equipment.



This symbol adjacent to an indication lamp means the heater power Off / On when lamp non-illuminated / illuminated.



This symbol adjacent to the stirrer switch denotes the uni-directional stir condition.



This symbol adjacent to the stirrer switch denotes the stirrer manual capture condition or stirrer off.



Bio Chemical Hazard. Caution required. Will require decontamination.



3. SAFETY INFORMATION.

This product has been designed for safe operation when used as detailed in accordance with the Manufacturers instructions.

NOTE: Failure to use this equipment in accordance with the manufactures instruction manual may compromise your basic safety protection afforded by the equipment and may invalidate the warranty / guarantee. The warranty / guarantee does not cover damaged caused by faulty installation or misuse of the equipment

3.1. Prevention of Fire and Electric Shock.



To prevent a risk of fire or electric shock, **DO NOT** open your *product* case without authorisation. Only qualified Service personnel should attempt to repair this product.



Replace fuses only with the type as listed in section, 'Technical Specifications and Parts and Accessories' (See fuse type and rating).



Ensure the Mains Power Supply conforms to rating found on the data plate located on the back of this product.



Never Operate this equipment without connection to earth / ground. Ensure the mains supply voltage is correctly earthed / grounded in accordance with current area legislation.

3.2. General Safe Operating Practice.



Always follow good laboratory practice when using this equipment. Give due recognition to your company's safety and legislative health & safety procedures and all associated legislation applicable to your areas of operation. Check laboratory procedures for substances being heated and ensure all hazards (e.g. explosion, implosion or the release of toxic or flammable gases) that might arise have been suitably addressed before proceeding. When heating certain substances the liberation of hazardous gases may require the use of a fume cupboard or other means of extraction.



Ensure equipment is used on a clean, dry, non-combustible, solid work surface with at least 300mm suitable clearance all around from other equipment.



Do not position the product so that it is difficult to disconnect from the mains supply.



Do not touch the heating element or any glass vessel whilst in use.



Do not lean or stretch over equipment, glassware and fixings when in use.



Do not immerse unit in water or fluids.



Do not spill substances onto the mantle. If spillage does occur, disconnect unit from mains supply and follow instructions as detailed in Maintenance. (Section 9).



Do not cover the mantle whilst in use. **Do not** block or obstruct ventilation slots / airways.



Do not leave equipment switched on without a charged flask(s).



Do not thermally insulate the exposed upper section of the vessel(s), as the insulation used may obstruct the convection cooling airways around the rim of the cartridge enclosure and cause the mantle to overheat.



It is not recommended to leave any heating apparatus unattended during operation.



Only use Original Equipment manufactures spares and accessories. Ref Section 10.



Stirring versions of this equipment generate magnet fields. Keep all metal objects and magnetic data devices (e.g. credit cards) away from the stirrer unit.



The equipment is not spark, flame or explosion proof and has not been designed for use in hazardous areas in terms of BSEN 60079-14:1997. Keep flammable, low flash point substances away from the apparatus.



Do not operate or handle any part of the product with wet hands.



Keep the Mains cord and moulded IEC plug and lead set away from the heating surface.



ATTENTION:-

With high energy input and certain configurations of glassware in EMV & EMX products, where the heating contact of the glassware is relatively small, localised heating and subsequent 'bumping' of the fluid being heated may occur. Application advice should be sought from the manufacturer.

4. UNPACKING AND CONTENTS.

4.1. Product Identification:

The model number allocated to each type of mantle is descriptive. The method of coding is detailed below.

STIRRING AND NON-STIRRING MODELS

Example

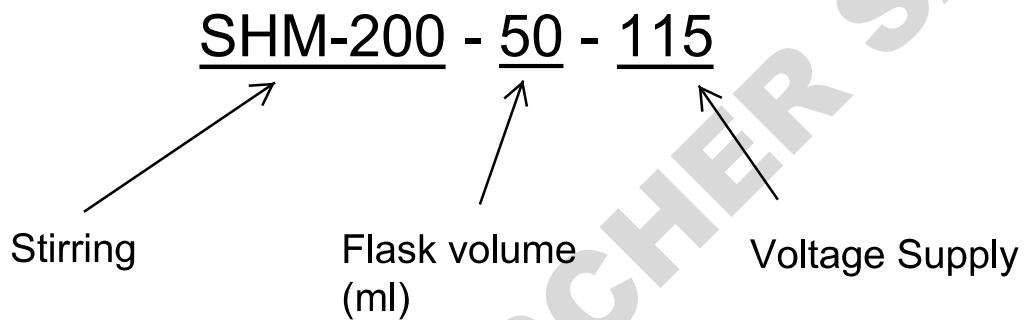

Note: Non-Stirring models are prefixed "HM-200"

HM-200 flask volume: 50ml, 100ml, 250ml, 500ml, 1000ml, 2000ml, 3000ml, 5000ml

SHM-200 flask volume: 50ml, 100ml, 250ml, 500ml, 1000ml

Supply Voltage: Model numbers not suffixed "-115" = 230V a.c

SPILLPROOF AND FUNNEL MODELS (WITH OPENING IN BASE)

Example

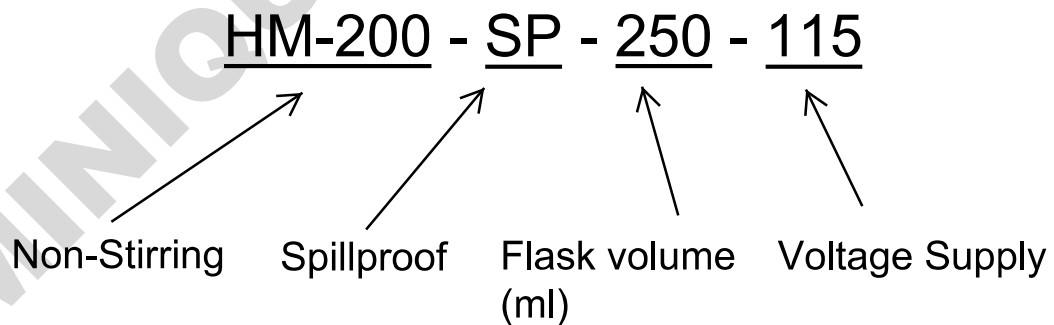

Note: Non-Stirring models only

Heating area configuration: SP = Spillproof (Stainless Steel liner) with opening in base for funnel
V = Opening in base for funnel

HM-200-SP flask volume: 1000ml, 5000ml

SHM-200-V flask volume: 50ml, 250ml, 1000ml

Supply Voltage: Model numbers not suffixed "-115" = 230V a.c

Please check the contents of your carton against the relevant product diagram.

Applicable to all HM-200 and SHM-200 product Range.

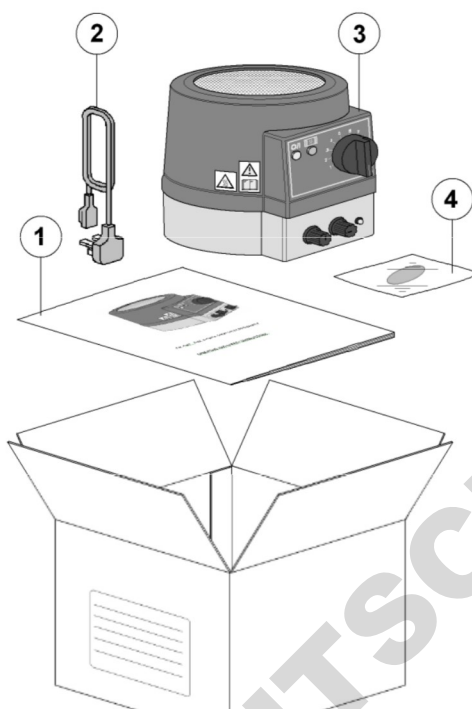

Item No	Description	Qty
1	Instruction manual	1
2	Mains cord and moulded IEC plug and lead set <i>(May differ from illustration depending on destination).</i>	A/R
3	Product (<i>Model shown SHM-200</i>)	1
4	Stir bar (<i>only on SHM-200</i>)	1

For future reference please record your products Serial and Model Numbers.	Serial Number	Unit Model/Cat Number

5. INSTALLATION.

5.1. Electrical safety and installation.

5.1.1. This equipment is designed to be used safely under the following conditions:-

- Indoor use.
- Altitude up to 2000 meters.
- Temperatures between 5°C and 40°C.
- Maximum relative humidity 80% for temperatures up to 31°C decreasing linearly to 50% relative humidity at 40°C.
- Mains supply voltage fluctuations up to $\pm 10\%$ of the nominal voltage.
- Transient overvoltages typically present on the mains supply. Overvoltage category II
- Applicable rated pollution degree 2.

5.1.2.  This equipment must be earthed / grounded to a fixed earth / grounded mains socket outlet. The mains supply is to earthed / grounded in accordance with current legislation. See Technical Specification for recommended fuse ratings.

5.1.3. Ensure only the correct rated mains input fuses are fitted. (Where applicable ensure the correct Mains cord and moulded IEC plug and lead set fuse if fitted). See Technical Information Section 8 of this Instructions Manual.

5.1.4. Check the voltage on the product data label on this product unit and those of any accompanying electrical accessory. Ensure the rating conforms to your local supply.

5.1.5. This product should be connected to a mains supply source which incorporates a RCD or GFCI device that has a tripping current of 30mA or less. The RCD or GFCI residual Current Device cuts off power to the equipment immediately it detects a current leakage fault. For example, cutting off the power when there is an accidental liquid spillage in a mantle protected with an earth (ground) screen.

5.1.6.  Do not install this product or accessories on a surface which may become flooded.

5.1.7. The unit is supplied with a Mains cord and moulded IEC plug and lead set wired as follows.



Green / Yellow or **Green** = **Earth / Ground**

Blue or **White** = **Neutral**

Brown or **Black** = **Live / line hot.**

5.2. **Observation:** the surface of the heating element of a mantle cartridge will upon receipt look slightly discoloured. This discolouration is normal and occurs at the factory during test when the mantle is first heated up.

5.3. Cole-Parmer controllers, series CN-200-2300 / CN-200-1100-115 / CN-200-1800 / CN-200-800 and CN-200D, can also be used for external control when the mantle is used in a fume cupboard. NOTE: External controllers cannot be used for EMA or EMEA products.

USA Notification.

Warning! Any modification or changes made to this device, unless explicitly approved by Antylia Scientific, will invalidate the authorisation of this device. Operation of an unauthorised device is prohibited under Section 302 of the Communications Act of 1934 as amended, and Subpart 1 of Part 2 of Chapter 47 of the code of Federal Regulations.

Note: This equipment has been tested and found to comply with the limits for a Class B digital device, pursuant to part 15 of the FCC Rules. These limits are designed to provide reasonable protection against harmful interference in a residential installation. This equipment generates, uses and can radiate radio frequency energy and, if not installed and used in accordance with the instructions, may cause harmful interference to radio communications. However, there is no guarantee that interference will not occur in a particular installation. If this equipment does cause harmful interference to radio or television reception, which can be determined by turning the equipment off and on, the user is encouraged to try to correct the interference by one or more of the following measures:

- Reorient or relocate the receiving antenna.
- Increase the separation between the equipment and receiver.
- Connect the equipment into an outlet on a circuit different from that to which the receiver is connected.
- Consult the dealer or an experienced radio/TV technician for help.

6. ENVIRONMENTAL PROTECTION.

6.1. Maximum consideration has been given to environmental issues within the design and manufacturing process without compromising end product performance and value.



6.2. Packaging materials have been selected such that they may be sorted for recycling.



6.3. At the end of your product and accessories life, it must not be discarded as domestic waste. Ref: EU Directive 2002/96/EC on Waste Electrical and Electronic Equipment Directive (WEEE). Please contact your distributor / supplier for further information. For end users outside of the EU consult applicable regulations.

6.4. This product should only be dismantled for recycling by an authorised recycling company.



This product and accessories must be accompanied by a completed Decontamination Certificate prior to any disposal. Copies of the Certificate are available from Distributor/Manufacturer.

7. PRODUCT OPERATION.

7.1. HM-200, SHM-200 HM-200-V and HM-200-SP Mantle with controller.

7.1.1. Overview of HM-200 Mantle with controller.

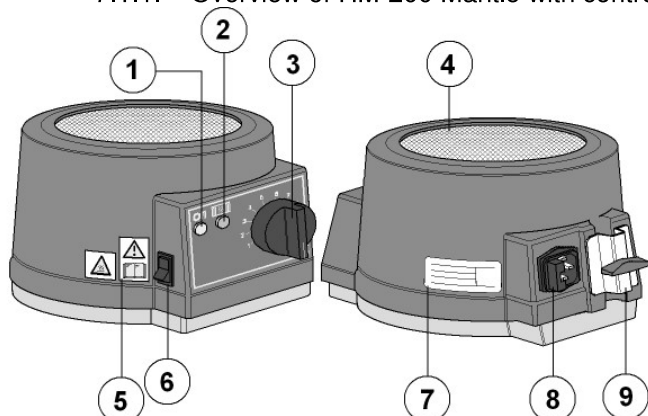

Note: Circuit selection switch (only for mantles with two heating circuits).

Position I is for lower heating circuits only.
Position II is for both circuits on.

Note: If an external controller is to be used, always set the energy regulator control knob to maximum setting 10.

Item	Description.
1	Mains power on indicator
2	Heating element on
3	Energy regulator control knob
4	Heating Element 
5	Warning Labels. (Hot surface and refer to this Instructions Manual).
6	Circuit selection switch (for mantles with two heating circuits)
7	Data Plate
8	Mains input IEC socket (Contains protective fuses).
9	Support rod bracket. (Note for 2, 3 & 5 litre variants 3 clamp positions are fitted).

Note: The **SHM-200-V** and **SHM-200-SP** series mantles both have bottom opening for use with a funnel. SHM-200-SP has a spill proof liner. Both units may be raised up using a retort rod stand allowing for heated filtration of the sample.

Both mantles can be supported using the rod clamp arrangement as illustrated.

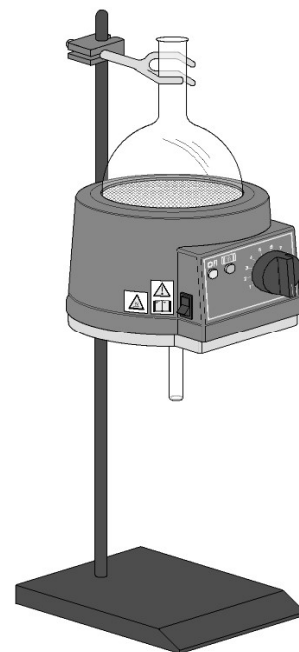

7.1.2.  When heating a funnel in an HM-200-V or HM-200-SP the mantle should be securely supported above the work surface using the support rod clamps.

7.1.3. With the mains electricity supply switched off, connect the Mains cord and moulded IEC plug and lead set to the mains IEC socket.

7.1.4. Place a charged, clean, dry glass vessel of the size indicated on the mantle data plate label. Wherever possible the glass vessel should be supported within the mantle by means of the support rod and clamp.

7.1.5. Switch on the mains electrical supply. Adjust the controller regulator knob to the required setting.

NOTE: The 'mains power on' indication neon will illuminate. The 'amber heating on' neon will illuminate / pulsate when the heaters are in operation.

7.1.6. When the process is complete switch the regulator knob to the off position. Disconnect the mains electricity supply.

7.1.7.  Remove charged vessel. Handle hot charged vessel with care.

7.2. SHM-200 Mantle (With controller and stir facility).

7.2.1. Overview of SHM-200 Mantle with stir facility.

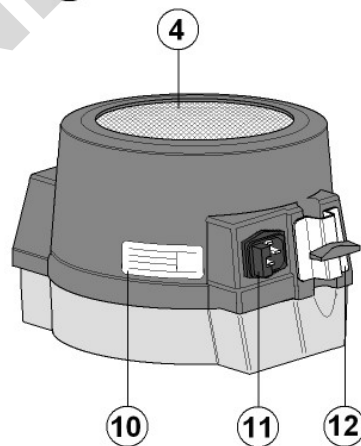
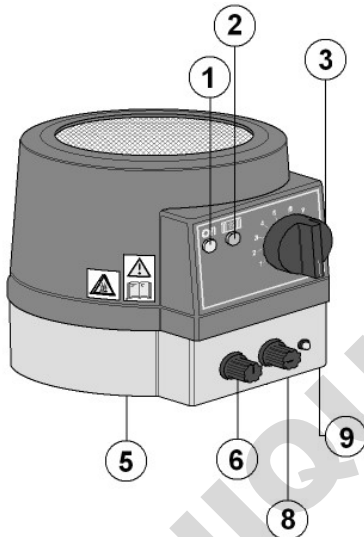



Item	Description.
1	Mains power on indicator
2	Heating element on
3	Energy regulator control knob
4	Heating Element 
5	Warning Labels. (Hot surface and refer to this Instructions Manual).
6	Stir speed adjustment.
8	Stir selection rotary switch.
9	Stir facility 'on' LED indicator.
10	Data Plate
11	Mains input IEC socket (Contains protective fuses).
12	Support rod bracket. (Note for 2, 3 & 5 litre variants 3 clamp positions are fitted).

- 7.2.2. With the mains supply electricity switch off, Connect the Mains cord and moulded IEC plug and leads set to the mains IEC socket. Ensure the stirrer rotary switch is in the off position.
- 7.2.3. Place a charged, clean, dry glass vessel of the size indicated on the mantle data plate. Wherever possible the glass vessel should be supported within the mantle by means of the support rod and clamp.
- 7.2.4. Switch on the mains electrical supply. Adjust the Energy regulator control knob to the required setting.

NOTE: The mains power on indication neon will illuminate. The amber heating on neon will illuminated when the heaters are in operation.

- 7.2.5. On the SHM-200 there are two stirring functions available.
- Bi-directional with auto capture and auto reverse period of approximately 20 / 30 seconds.
 - Uni-directional up to 500RPM approximately.
 - Manual capture / reset is achieved with the rotary switch in the off position.
- 7.2.6. Carefully place the stirrer bar provided into the vessel and turn the rotational speed control to its minimum position.
- 7.2.7. Select the required stir function on the stir selection rotary switch. The green LED will now illuminate.
- 7.2.8. Adjust the rotational speed by means of the speed control knob. Should the stirring action be lost by over rotation, then reduce the stir speed slightly and recapture the stir bar by selecting the off position on the stir selection rotary switch
- 7.2.9. When the process is complete switch the stir speed and regulator knobs to there off positions. Disconnect the mains electricity supply.

- 7.2.10.   Remove charged vessel. Handle hot charged vessel with care.

8. TECHNICAL SPECIFICATION.

8.1. Specifications HM-200 range (General).

Fuse type	20mm x 5mm Glass Quickblow. (2 per unit) See below for rating.
Heating Element Construction.	Thermal insulated element wire stitched into a cartridge construction.
Maximum Element temperature.	450°C. Nominal Max.
EM Case construction.	Polypropylene.
Thermal Insulation	Ceramic Fibre.

8.1.1. Power Consumption and fuse ratings.

Type	Size	Total Heating Power (Watts).		Fuse rating (Amps)	
		220/240V~	115V~	220/240V~	115V~
HM-200	50ml	60	70	F0.5	F1.25
	100ml	60	70	F0.5	F1.25
	250ml	150	150	F1.25	F2.5
	500ml	200	200	F1.25	F2.5
	1000ml	300	300	F2.5	F3.15
	2000ml	500	500	F2.5	F6.3
	3000ml	500	500	F2.5	F6.3
SHM-200	50ml	60+(20stir)	76+(20stir)	F0.5	F1.25
	100ml	60+(20stir)	76+(20stir)	F0.5	F1.25
	250ml	150+(20stir)	190+(20stir)	F1.25	F2.5
	500ml	200+(20stir)	250+(20stir)	F1.25	F2.5
	1000ml	300+(20stir)	380+(20stir)	F2.5	F6.3
	2000ml	500+(20stir)	650+(20stir)	F2.5	F6.3
	5000ml	500+300	500+300	F6.3	F6.8
The power consumption of the stir facility is 20 Watts.					
HM-200-V	50ml	60	70	F0.5	F1.25
	250ml	100+50	100+50	F1.25	F2.5
	1000ml	200+100	200+100	F2.5	F3.15
	5000ml	500+300	500+300	F6.3	F8
HM-200-SP	1000ml	165+80	160+80	F1.25	F2.5
	5000ml	400+200	400+200	F6.3	F10

8.1.2. The Ingress protection rating for the HM-200, HM-200-MP3 & MP6, HM-200-V SHM-200 product range is IPX0.

For the HM-200-SP range the Ingress protection rating is IPX1.

8.1.3. Dimensions and Weight (unpacked).

HM-200-50

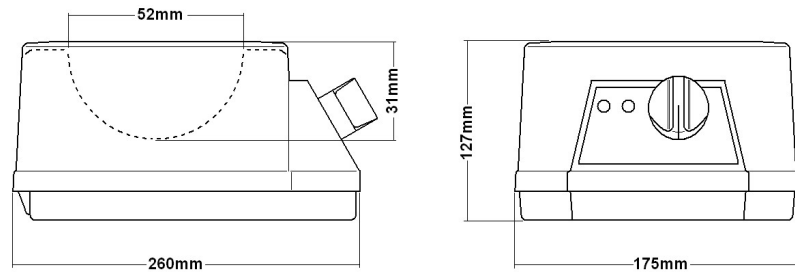

WEIGHT 0.78Kg

HM-200-100

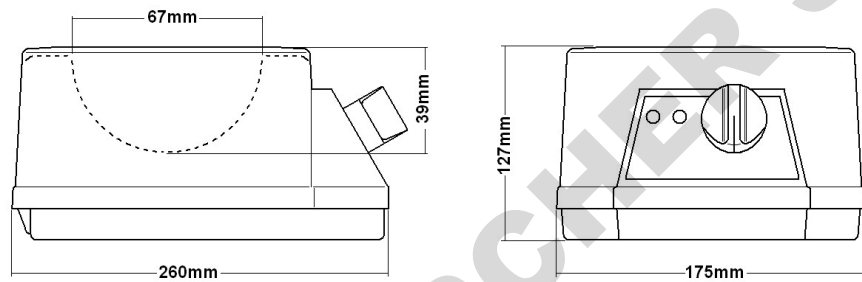

WEIGHT 0.78Kg

HM-200-250

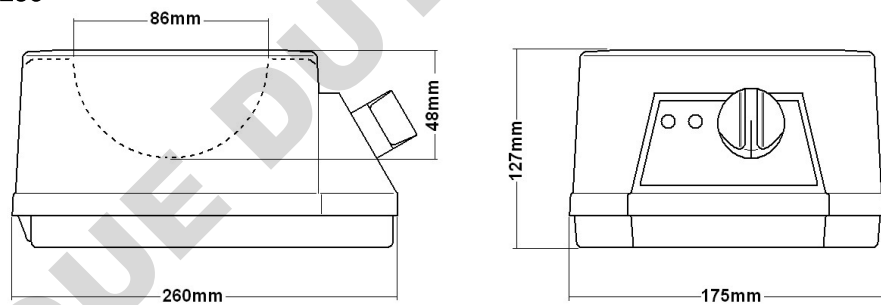

WEIGHT 0.78Kg

HM-200-500

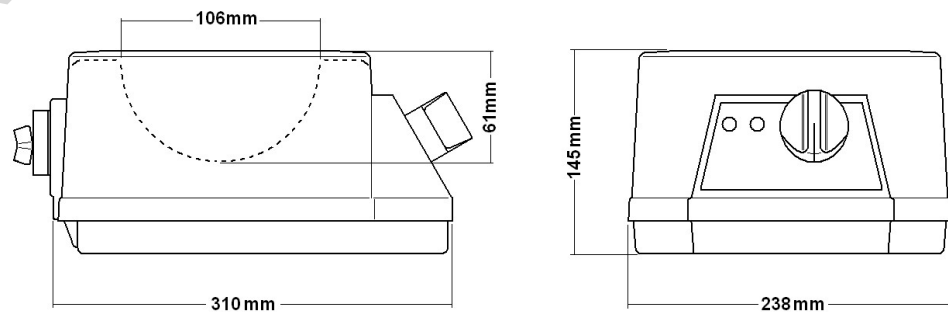

WEIGHT 1.25Kg

HM-200-1000

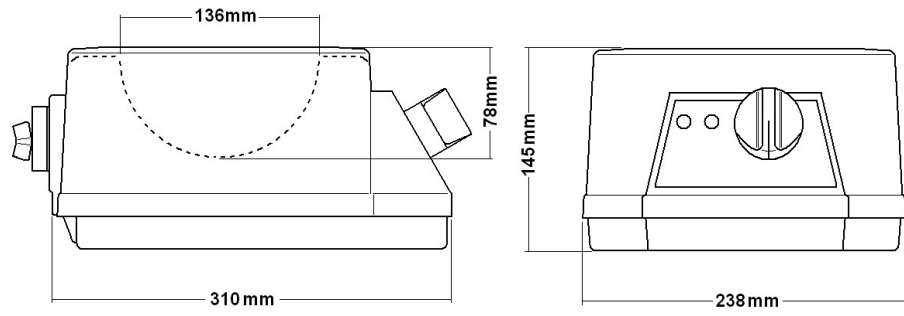

WEIGHT 1.25Kg

HM-200-2000

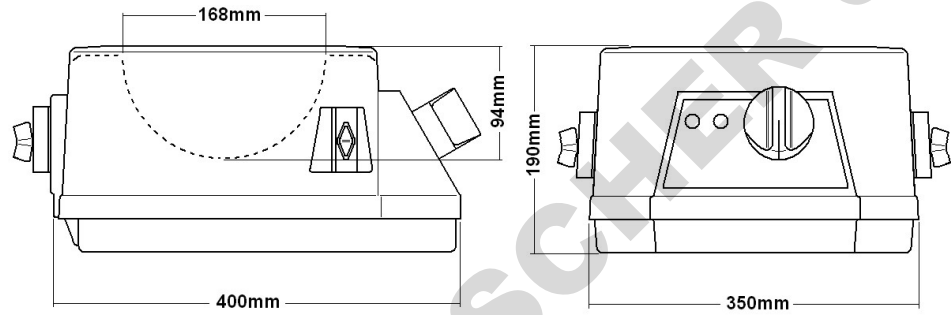

WEIGHT 2.58Kg

HM-200-3000

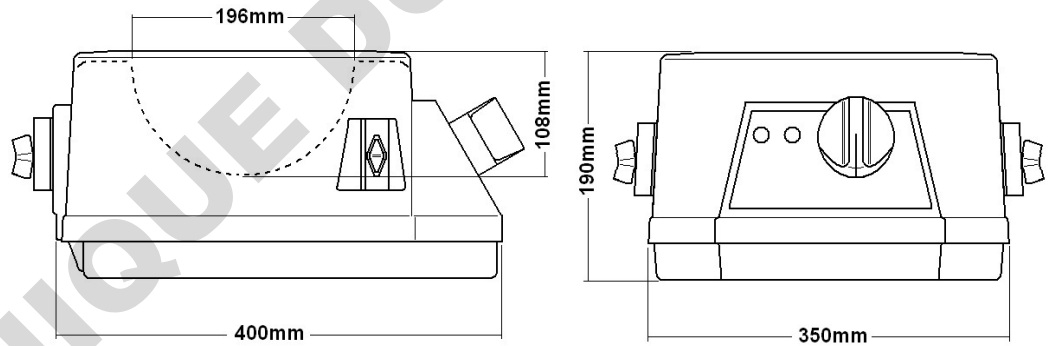

WEIGHT 2.58Kg

HM-200-5000

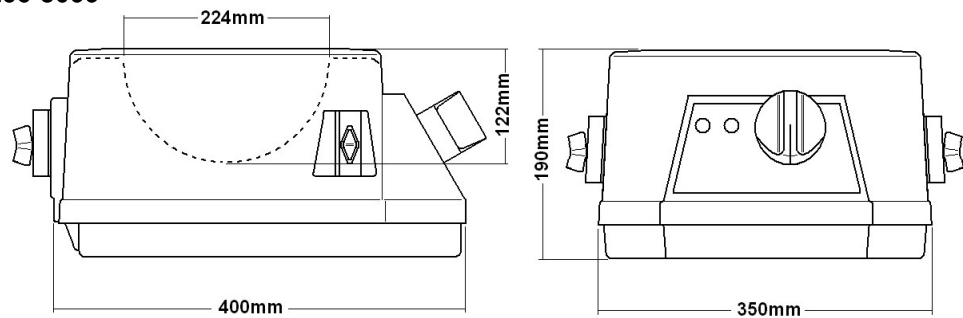

HM-200-V-50. Glass sizes 10 – 50ml.

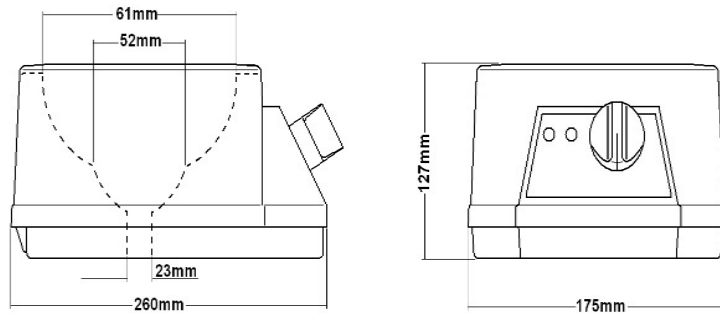

WEIGHT 0.78Kg.

HM-200-V-250. Glass size 100 – 250ml.

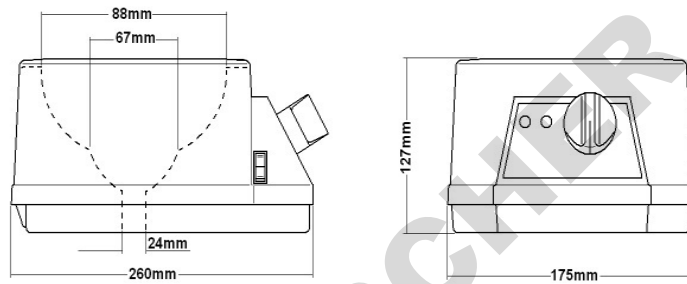

EMV0250/CE

WEIGHT 0.78Kg.

HM-200-V-1000. Glass size 500 – 1000ml
HM-200-SP-1000 Glass size 50 to 1000ml

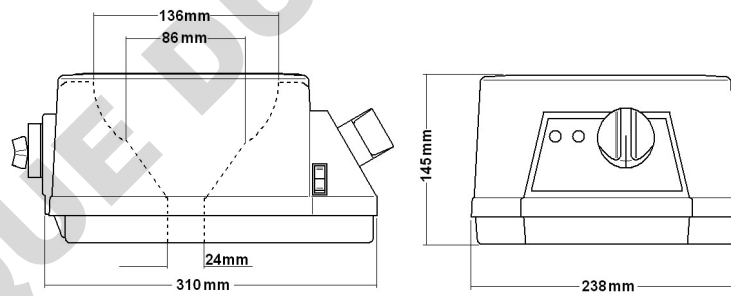

WEIGHT 2.76Kg

HM-200-V-5000. Glass size 2000 – 5000ml.
HM-200-SP-5000 Glass size 500 to 5000ml

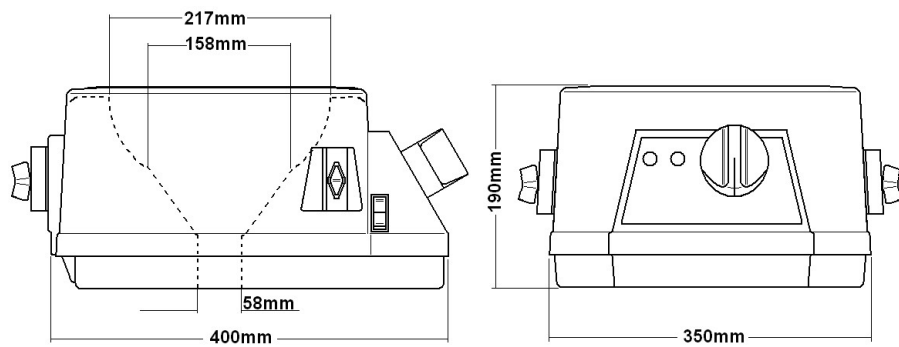

WEIGHT 5.69Kg

SHM-200-50

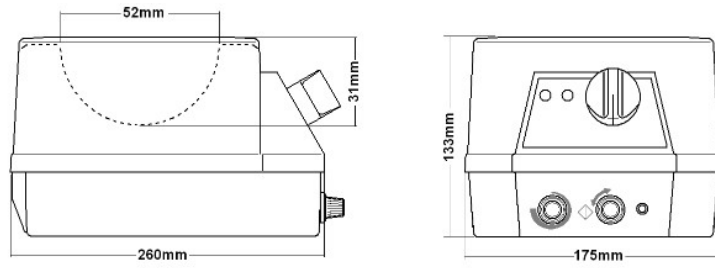

WEIGHT 1.73Kg

SHM-200-250

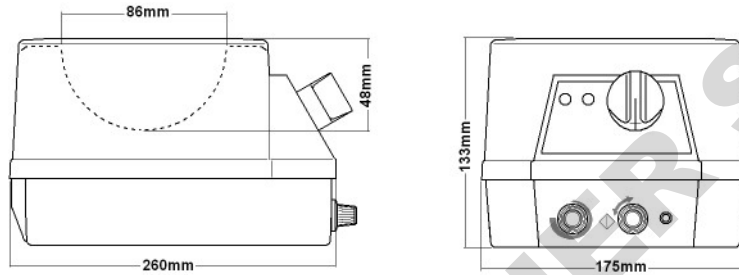

WEIGHT 1.73Kg.

SHM-200-500

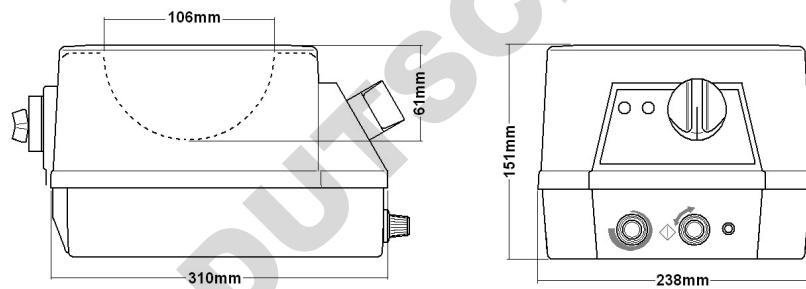

WEIGHT 2.75Kg.

SHM-200-1000

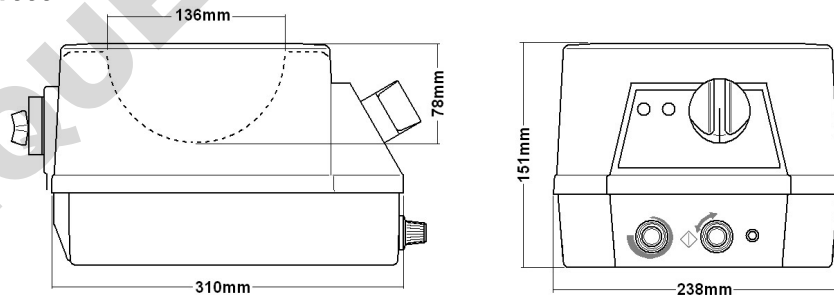

WEIGHT 2.75Kg

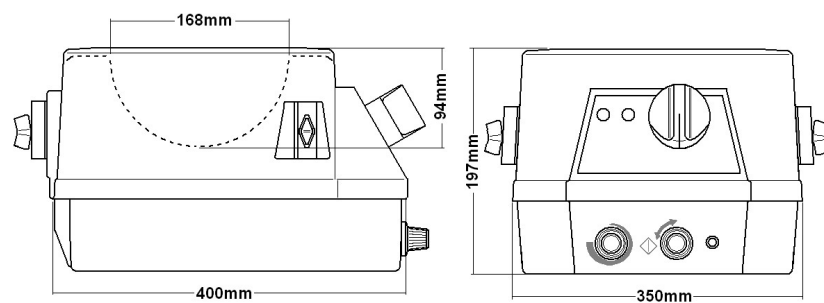

SHM-200-2000



WEIGHT 5.68Kg

9. MAINTENANCE.

9.1. General Information.

  Unplug the unit from the mains voltage supply and allow it to cool before undertaking any maintenance tasks.

 Maintenance should only be carried out under the direction of the Responsible Body, by a competent electrician. Failure to do so may result in damage to the product and in extreme cases be a danger to the end user.

With proper care in operation this equipment has been designed to give many years of reliable service. Contamination or general misuse will reduce the effective life of this product and may cause a hazard.

Maintenance for the unit should include:

- Periodic electrical safety testing (an annual test is recommended as the minimum requirement).
- Regular inspection for damage with particular attention to the mains lead and plug set.
- Routine cleaning of the equipment should be undertaken using a clean cloth.

DO NOT USE SOLVENTS FOR CLEANING ANY PART OF THIS EQUIPMENT.

9.2. Fuse Replacement.

The mains fuse holder is located at rear your product. Refer to Technical specification, 'Fuse Rating' for correct fuse type and rating. Turn your product off and disconnect it from the mains supply.

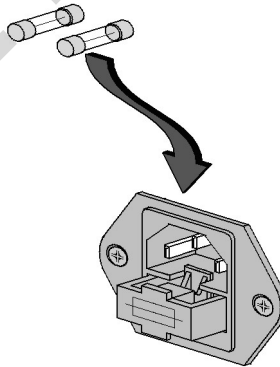

9.2.1. Heater Cartridge replacement.

 **Attention.** The heater contains insulation material made from Refractory Ceramic Fibres (RCF), classified as a category 2 carcinogenic under EU Directive 67/548/EC. Follow the guidelines for working with RCF as laid down under in the ECFIA Code of Practise. Wear suitable protective clothing and gloves.



In the event of a heater element becoming damaged or open circuit the follow procedure should be adopted for its replacement.

HM-200 and SHM-200

- 9.2.1.1. Unplug or disconnect the mantle from the mains electricity supply.
- 9.2.1.2. The **(S)HM-200** single heater mantles should be turned over and placed upside down on a clean dry surface.
- 9.2.1.3. Remove the plastic rivets from around the base of the mantle and remove the base.
- 9.2.1.4. On 2,3 and 5 litre models remove the 3 cross-head screws and remove the triangular base plate.
- 9.2.1.5. On **(S)HM-200** product remove the 2 cross-head screws retaining the base bracket then hinge the bracket clear of the heater cartridge.
- 9.2.1.6. Disconnect the two or four heater cold leads. (The number of leads is dependant on single / double element configuration).
- 9.2.1.7. Lift the heater cartridge out of the case without disconnecting the earth connection to the metal ring.
- 9.2.1.8. The new heater cartridge is then fitted into the metal ring and the heater cold leads reconnected.
- 9.2.1.9. On **(S)HM-200** product replace the base bracket. On the 2, 3 and 5 litre models replace the triangular base plate and refit the 3 screws.
- 9.2.1.10. Replace the earth lead and base and refasten using the previously removed plastic rivets.
- 9.2.1.11. The responsible body shall check the electrical safety of the product before further use.

9.3. Spillage and Decontamination.

Spillage:

In the event of spillage or glassware fracture, do not touch the mantle. Disconnect the product from the mains electrical supply. Allow the product to cool. Wearing suitable hand protection (giving due consideration to substances that were being heated) carefully remove any pieces of broken glassware. If decontamination is necessary, see section below. Otherwise wipe off all excess liquid from the mantle and surrounding area using an absorbent soft cloth. Drain of any residual fluid retained in the mantle. In the case of excessive spillage/ flask fracture, invert the mantle and allow it to drain for minimum of one hour. Then proceed with the following drying out procedure. Place the complete mantle, the correct way up, in a heated oven at 50 °C for a minimum period of 40 hours

! Warning: The equipment cannot be assumed to meet all the safety requirements of EN 61010-2-010: 2003 during the drying out process and until the drying out process is completed.

If in doubt please consult Customer Support. Refer to section 11.” NB: Replacement heater cartridges are obtainable from your Distributor/Manufacturer.



Before further use, the mantle must be subjected to electrical safety testing by competent service personnel.

If in doubt please consult Customer Support. Refer to section 11.



If the equipment has been exposed to contamination, the Responsible Body is responsible for carrying out appropriate decontamination. If hazardous material has been spilt on or inside the equipment, decontamination should only be undertaken under the control of the Responsible Body with due recognition of possible hazards. Before using any cleaning or decontamination method, the Responsible Body should check with the manufacturer the proposed method will not damage the equipment.

Prior to further use, the Responsible Body shall check the electrical safety of the unit. Only if all safety requirements are met can the unit be used again. The above procedure is intended as a guide. Should spillage occur with a toxic or hazardous fluid then special precautions may be necessary.

Decontamination Certificate.

Note: In the event of this equipment or any part of the unit becoming damaged, or requiring service, the item(s) should be returned to the manufacturer for repair accompanied by a decontamination certificate. Copies of the Certificate are available from Distributor/Manufacturer.

At the end of life, this product must be accompanied by a Decontamination Certificate. See section 6.3 and 6.4

10. PARTS AND ACCESSORIES

10.1. Replacement Heater Cartridges. All Cole-Parmer mantles are specified by the letters RE and Flask size. Add x1 suffix when ordering for 115V

For all 220/240 volt product quote the Non x1 part number.

Mantle model type		Replacement heater Cartridge.
HM-200-50	Order	RE0050
HM-200-100	Order	RE0100
HM-200-250	Order	RE0250
HM-200-500	Order	RE0500
HM-200-1000	Order	RE1000
HM-200-2000	Order	RE2000
HM-200-3000	Oder	RE3000
HM-200-5000	Order	RE5000
SHM-200-50	Order	REA0050
SHM-200-100	Order	REA0100
SHM-200-250	Order	REA0250
SHM-200-500	Order	REA0500
SHM-200-1000	Order	REA1000
SHM-200-2000	Order	REA2000
HM-200-SP-1000	Order	REMX1000
HM-200-SP-5000	Order	REMX5000
HM-200-V-50	Order	REMV0050
HM-200-V-250	Order	REMV0250
HM-200-V-1000	Order	REMV1000
HM-200-V-5000	Order	REMV5000

10.2. REPLACEABLE PARTS.

Order Number	Description.	Quantity
AZ9021	Spares Pack Simmerstat Controller	1
AZ9034	Fuse: F10A	10
AZ9035	Fuse: F8A	10
AZ9036	Fuse: F6.3A	10
AZ9038	Fuse: F0.5A	10
AZ9040	Fuse:F2.5A	10
AZ9041	Fuse: F3.15A	10
AZ9130	Fuse; F3A	10
CRM5607	Neon: Clear (230V)	1
CRM5608	Neon: Amber (230V)	1
CRM5619	Neon: Clear (115V)	1
CRM5620	Neon: Amber (115V)	1
CRM5621	Switch, Element Selection (EMX, EMV).	1
129320/3	Support rod (710mm / 28 " long).	1
129320/4	Support rod (1160mm / 45" long).	1
129320/5	Support rod (1440mm / 55" long).	1
129320/6	Support rod (590mm / 23" long).	1
HH179(S)	UK mains lead moulded plug	1
HH180(S)	European mains lead with plug	1
CRM6288	US moulded plug/lead set	1

11. CUSTOMER SUPPORT.

For help and support in using this product, please contact Customer Services at the following address.

Antylia Scientific Ltd.

Beacon Road,
Stone,
Staffordshire,
ST15 0SA,
United Kingdom
Tel: +44 (0)1785 812121

General enquiries: cpinfo@antylia.com
Order enquiries: cpsales@antylia.com
Technical support: cptechsupport@antylia.com

www.coleparmer.com

DOMINIQUE DUTSCHER SAS

12. NOTES.

DOMINIQUE DUTSCHER SAS



This product meets the applicable CE Directives and UKCA Legislation for radio frequency interference and may be expected not to interfere with, or be affected by, other equipment with similar qualifications. We cannot be sure that other equipment used in its vicinity will meet these standards and so we cannot guarantee

that interference will not occur in practise. Where there is a possibility that injury, damage or loss might occur if equipment malfunctions due to radio frequency interference, or for general advise before use, contact the manufacturer.

Declaration of Conformity is available to view online at www.coleparmer.com

DOMINIQUE DUTSCHER SAS

EU Representative address

Antylia Scientific GmbH
Futtererstraße 16
97877 Wertheim
Deutschland
Tel: +49 9377 9203-0
Email: sales@coleparmer.de

UK Representative address

Antylia Scientific
9 Orion Court
Ambuscade Road
Colmworth Business Park
St. Neots
PE19 8YX
United Kingdom
Tel: +44 (0) 1480 277339
Email: enquiries@antylia.com

Ordering Information

Order No.	Series	Model	Legacy SKU
36002-02	HM-200	HM-200-50	EM0050/CE
36002-00	HM-200	HM-200-50-115	EM0050/CEX1
36002-06	HM-200	HM-200-100	EM0100/CE
36002-04	HM-200	HM-200-100-115	EM0100/CEX1
36002-10	HM-200	HM-200-250	EM0250/CE
36002-08	HM-200	HM-200-250-115	EM0250/CEX1
36002-14	HM-200	HM-200-500	EM0500/CE
36002-12	HM-200	HM-200-500-115	EM0500/CEX1
36002-18	HM-200	HM-200-1000	EM1000/CE
36002-16	HM-200	HM-200-1000-115	EM1000/CEX1
36002-22	HM-200	HM-200-2000	EM2000/CE
36002-20	HM-200	HM-200-2000-115	EM2000/CEX1
36002-26	HM-200	HM-200-3000	EM3000/CE
36002-24	HM-200	HM-200-3000-115	EM3000/CEX1
36002-30	HM-200	HM-200-5000	EM5000/CE
36002-28	HM-200	HM-200-5000-115	EM5000/CEX1
04641-05	SHM-200	SHM-200-50	EMA0050/CEB
04641-00	SHM-200	SHM-200-50-115	EMA0050/CEBX1
04641-15	SHM-200	SHM-200-100	EMA0100/CEB
04641-10	SHM-200	SHM-200-100-115	EMA0100/CEBX1
04641-25	SHM-200	SHM-200-250	EMA0250/CEB
04641-20	SHM-200	SHM-200-250-115	EMA0250/CEBX1
04641-35	SHM-200	SHM-200-500	EMA0500/CEB
04641-30	SHM-200	SHM-200-500-115	EMA0500/CEBX1
04641-45	SHM-200	SHM-200-1000	EMA1000/CEB
04641-40	SHM-200	SHM-200-1000-115	EMA1000/CEBX1
04641-55	SHM-200	SHM-200-2000	EMA2000/CEB
04641-50	SHM-200	SHM-200-2000-115	EMA2000/CEBX1
36104-05	HM-200	HM-200-V-50	EMV0050/CE
36104-00	HM-200	HM-200-V-50-115	EMV0050/CEX1
36104-15	HM-200	HM-200-V-250	EMV0250/CE
36104-10	HM-200	HM-200-V-250-115	EMV0250/CEX1
36104-25	HM-200	HM-200-V-1000	EMV1000/CE
36104-20	HM-200	HM-200-V-1000-115	EMV1000/CEX1
36104-35	HM-200	HM-200-V-5000	EMV5000/CE
36104-30	HM-200	HM-200-V-5000-115	EMV5000/CEX1
36101-05	HM-200	HM-200-SP-1000	EMX1000/SCE
36101-00	HM-200	HM-200-SP-1000-115	EMX1000/SCEX1
36101-15	HM-200	HM-200-SP-5000	EMX5000/SCE
36101-10	HM-200	HM-200-SP-5000-115	EMX5000/SCEX1

Warranty Registration



Cole-Parmer®
essentials

Antylia Scientific Ltd
Beacon Road, Stone,
Staffordshire,
ST15 0SA,
United Kingdom

UK

T: +44 (0) 1480 272279
E: uk.sales@antylia.com
W: coleparmer.co.uk

Germany

T: +49 (0) 9377 92030
E: de.sales@antylia.com
W: coleparmer.de

France

T: +33 (0) 1486 37800
E: fr.sales@antylia.com
W: coleparmer.fr

Italy

T: +39 (0) 284349215
E: it.sales@antylia.com
W: coleparmer.it

India

T: +9122 61394444
E: info@coleparmer.in
W: coleparmer.in

China

T: +1 847 549 7600
E: sales@antylia.com
W: coleparmer.com

USA

T: +1 847 549 7600
E: sales@antylia.com
W: coleparmer.com

Canada

T: +514 355 6100
E: info@antylia.ca
W: coleparmer.ca

Other

T: +1 847 549 7600

