

phcbi

Operating Instructions

Pharmaceutical Refrigerator

MPR-1412

MPR-1412R Series



MPR-1412

Please read the operating instructions carefully before using this product and keep the operating instructions for future use.

See page 40 for all model numbers.

CONTENTS

INTRODUCTION	3
PRECAUTIONS FOR SAFE OPERATION	4
SAFE ENVIRONMENTAL CONDITIONS	9
SYMBOLS ON UNIT	9
REFRIGERATOR COMPONENTS	
Main body	10
Control panel	12
Inside the front over	13
INSTALLATION SITE	14
INSTALLATION	15
START-UP PROCEDURE	17
PLACEMENT OF STORED ITEMS	18
SETTING THE CHAMBER TEMPERATURE	19
LOCK OF CHAMBER TEMPERATURE SETTING	20
SETTING THE TEMPERATURE DISPLAY MODE	21
DEFROSTING THE EVAPORATOR	22
SETTING THE ALARM TEMPERATURE	
Setting the high-temperature alarm	23
Setting the low-temperature alarm	24
SETTING THE DELAY OF DOOR ALARM	25
SETTING THE BUZZER SUSPENDED PERIOD	26
OPERATION CHECK AFTER RECOVERY	26
REMOTE ALARM TERMINAL	27
SETTING OF ALARM BUZZER LINK MODE	27
ALARM FUNCTIONS	28
Air circulation alarm	28
SAFETY FUNCTIONS	28
SELF-DIAGNOSTIC FUNCTIONS	29
ROUTINE MAINTENANCE	
Cleaning of exterior, interior, and accessories	30
Cleaning of evaporating tray	30
Cleaning of condenser filter	31
TROUBLESHOOTING	32
DISPOSAL OF UNIT	33
Decontamination of unit	33
Refrigerant (applicable to MPR-1412-PE and MPR-1412R-PE)	33
TEMPERATURE RECORDER (OPTION)	38
BATTERY MOUNTING BOX (OPTION)	38
INTERFACE BOARD (OPTION)	38
SPECIFICATIONS	39
PERFORMANCE	40
SAFETY CHECK SHEET	41

INTRODUCTION

Read the operating instructions carefully before using the appliance and follow the instructions for safe operation.

Handling of Operating Instructions

- PHC Corporation never guarantees any safety if the appliance is used for any objects other than intended use or used by any procedures other than those mentioned in the operating instructions.
 - Keep the operating instructions in an adequate place to refer to it as necessary.
 - Contact our sales representative or agent if any page of the operating instructions is lost or page order is incorrect.
 - Contact our sales representative or agent if any point in the operating instructions is unclear or if there are any inaccuracies.
- ◇The operating instructions is only for the pharmaceutical refrigerator MPR-1412 and MPR-1412R made by PHC Corporation.
- ◇The contents are subject to change without notice.
- ◇No part of the operating instructions may be reproduced in any form without the expressed written permission of PHC Corporation.

Proposal for safe storage of refrigerator contents

This pharmaceutical refrigerator can store the medical or biological material in the low temperature environment. We can offer some precautions below to protect the valuable material against accidental temperature rise. Contact our sales representative or agent for the details or installation.

- Temperature recorder (Option)
- Battery mounting box (Option)
- Remote alarm system (Marketed product)

IMPORTANT NOTICE

PHC Corporation guarantees this product under certain warranty conditions. However, please note that PHC Corporation shall not be responsible for any loss or damage to the contents of the product.

<Intended Use>

This equipment is designed for storage of pharmaceuticals, samples and reagents.

PRECAUTIONS FOR SAFE OPERATION

It is imperative that the user comply with the operating instructions as they contain important safety advice.

Items and procedures are described so that you can use this unit correctly and safely. Following these precautions will prevent possible injury to the user and any other person.

Precautions are illustrated in the following way:

WARNING

Warning indicates a potentially hazardous situation which, if not avoided, could result in serious injury or death.

CAUTION

Failure to observe CAUTION signs could result in injury to personnel and damage to the unit and associated property.

PRECAUTIONS FOR SAFE OPERATION

WARNING

-  **Never damage the power supply cord or power supply plug (by breaking, adapting, placing near a source of heat, bending with force, twisting, pulling, adding weight, or binding).** A damaged power supply cord or power supply plug may cause electric shock, short circuit, or fire.
-  **Remove dust from the power supply plug periodically.** Dust on the power supply plug may cause insulation failure due to moisture and thus cause a fire. Disconnect the power supply plug and wipe it with a dry cloth.
-  **Make sure the power supply plug is pushed fully in.** Faulty insertion of the power supply plug may cause electric shock or fire due to generation of heat. Never use a damaged power supply plug or loose power outlet.
-  **Do not touch any electrical parts (such as power supply plug) or operate switches with a wet hand.** This may cause electric shock.
-  **Use a dedicated power source as indicated on the rating label attached to the unit.** A multiple-tap may cause fire resulting from abnormal heating.
-  **Do not use the unit outdoors.** Exposure to rain may cause leakage and/or electric shock.
-  **Only qualified engineers or service personnel should install the unit.** Installation by unqualified personnel may cause water leakage, electric shock, or fire.
-  **Install the unit in a location capable of bearing the total combined weight (product + optional accessories + stored items). After installing the unit, be absolutely sure to take precautions to prevent the unit from falling over.** If the unit is installed in a location which is not strong enough or if the proper precautions are not taken, the unit may fall over and cause injuries.
-  **Do not install the unit in a location where flammable or volatile substances are present.** Installing the unit in a location where flammable or volatile substances are present may cause explosions and/or a fire.
-  **Do not install the unit where there are high levels of moisture or where it may be splashed with water.** Installing the unit where there are high levels of moisture or where it may be splashed with water may cause the insulation to deteriorate and give rise to leakage and/or electric shock.
-  **Be absolutely sure to earth (ground) the unit in order to prevent electric shock.** Failure to earth the product may give rise to electric shock. If necessary, ask a qualified contractor to do this work.
-  **Do not connect the earth wire to a gas pipe, water pipe, or lightning rod when earthing the unit.** Earthing the unit improperly may give rise to electric shock.

PRECAUTIONS FOR SAFE OPERATION

WARNING

 **Never store volatile or flammable substances in this unit except in a sealed container.** Such substances may cause explosion or fire if they leak.

 **Never insert metal objects such as pins and wires into any vent, gap, or outlet on the unit.** This may cause electric shock or injury by accidental contact with moving parts.

When handling harmful samples (for example, those which consist of toxic, pathogenic, or radioactive substances), install the unit inside a designated isolation facility. If the unit is installed in a location which is not an isolation facility, there may be detrimental effects on both people and the natural environment.

 **Before proceeding with maintenance or checking of the unit, set the power switch to OFF and disconnect the power supply plug.** Performing the work while power is still flowing to the product or while the power supply plug is still connected may give rise to electric shock and/or injury.

 **Wear protective gloves and mask during maintenance.** Touching or inhaling chemicals or aerosols from around the unit may be detrimental to health.

 **Never splash water directly onto the unit** as this may cause electric shock or short circuit.

 **Never put containers with liquid on top of the unit** as this may cause electric shock or short circuit if the liquid is spilled.

 **Never disassemble, repair, or modify the unit yourself.** A high-voltage area is located inside the unit. Any work carried out by unauthorized personnel may result in electric shock. Contact our sales representative or agent for maintenance or repair.

 **Disconnect the power supply plug if there is anything wrong with the unit.** Continued abnormal operation may cause electric shock or fire.

 **Grip the power supply plug when disconnecting the power supply cord from the outlet.** Pulling the power supply cord may cause electric shock or short circuit.







 **Disconnect the power supply cord when the unit is not in use for long periods.** Keeping the unit connected may cause electric shock, leakage, or fire due to the deterioration of insulation.

 **Do not place this unit in a location where it is difficult to disconnect the power supply plug.** Failure to disconnect the power supply plug may cause fire in the event of a problem or malfunction.

 **If the unit is to be stored unused in an unsupervised area for a long period, ensure that children do not have access and that doors cannot be closed completely.**

PRECAUTIONS FOR SAFE OPERATION

WARNING

-  **Ask a qualified contractor to carry out disassembly and disposal of the unit.** Leaving the unit in a location that can be accessed by third parties may result in unexpected accidents (e.g. the unit may be used for unintended purposes).
-  **Do not leave the plastic bags used for packing in a place where they can be reached by small children** as this may result in unexpected accidents such as suffocation.
-  **When moving the unit, be sure to take precautions to prevent it from falling over.** Moving the unit with too much force may cause it to fall over, possibly resulting in injury. A qualified individual must be assigned to supervise the safe movement and relocation of the unit.
-  **Do not install the unit in a location where corrosive gases such as acids are present.** Installing the unit in a location where corrosive substances are present may cause electric components to corrode, leading to leakage and/or electric shock due to the deterioration of insulation resulting from corroded electrical components.
-  **Connect the unit to a power source as indicated on the rating label attached to the unit.** Use of any other voltage or frequency other than that on the rating label may cause fire or electric shock.
-  **Never replace the battery for the power failure alarm yourself.** Only qualified engineers or service personnel should replace the battery.
-  **Install the unit in a well-ventilated (airy) location to prevent the accumulation of flammable refrigerant.** The flammable refrigerant may cause fire if it leaks.

Flammable and explosive product





The unit contains flammable refrigerant. When repairing or recycling, only trained service personnel will repair and follow the procedure below.

- Well ventilate the room to prevent refrigerant accumulation.
- Keep fire away when the refrigerant is contained in the product.
- Do not damage or break the pipework.
- When replacing parts, use parts of the same type.
- The appliance shall be stored in a room without continuously operating ignition sources (for example: open flames, an operating gas appliance or an operating electric heater).
- Do not pierce or burn.
- Be aware that refrigerants may not contain an odour.













-  **The unit contains flammable refrigerant and flammable blowing gas. When the unit is disassembled or disposed of, the work must be performed in a well-ventilated place and avoid the place near fire.**

It may cause explosions and/or a fire in case of refrigerant or gas leakage.

-  **Do not give strong shock or vibration during movement or use.** The piping may be damaged, causing a fire.
-  **Do not use electrical appliances in the chamber.** If the refrigerant leaks, sparks from the electrical contacts could cause a fire or explosion.

PRECAUTIONS FOR SAFE OPERATION

CAUTION

-  **This unit must be plugged into a dedicated circuit** protected by branch circuit breaker.
-  **Use a dedicated power source as indicated on the rating label attached to the unit.** A multiple-tap may cause fire resulting from abnormal heating.
-  **Do not climb on top of the unit or put any objects on the unit.** Falling from the unit may cause injury; falling objects may cause damage to the unit.
-  **Never install the unit in a location where corrosive materials such as sulphur compounds are likely to be generated (e.g. near a drainage facility).** Corrosion of the copper pipes may result in deterioration and consequently the failure of the cooling unit.
-  **Take care when installing the shelves or drawers.** They may cause injury if they fall down.
-  **Before resuming operation after the unit has been turned off, be absolutely sure to check the settings.** The settings may have changed as a result of stopping the unit. Items stored inside the unit may be adversely affected if operation of the unit is resumed with changed settings.
-  **Never store corrosive substances such as acids or alkalis in the unit except in a sealed container.** These may be detrimental to health and may cause corrosion of internal components, cooling circuit or electrical components.
-  **When moving the unit, contact our sales representative or agent.** The moving by a user may cause damage or injury resulting from tipping over of the unit.
-  **Disconnect the power supply plug before moving the unit.** Take care not to damage the power supply cord. A damaged cord may cause electric shock or fire.
-  **To ensure the safety of the service engineer, submit a safety check sheet with the required items filled out.** This is provided as the photocopyable "Safety Check Sheet" at the end of these operating instructions.
- Flammable and explosive product**
 -  The unit contains flammable refrigerant. Consult repair manual/owner's guide before attempting to install or service this product. All safety precautions must be followed.
-  **Flammable refrigerant is used.** Dispose of the unit properly in accordance with national or local regulations.





SAFE ENVIRONMENTAL CONDITIONS

This equipment is designed to be safe at least under the following conditions:

- Indoor use;
- Altitude up to 2000 m;
- Temperature 5 °C to 40 °C
- Maximum relative humidity 80 % for temperature up to 31 °C decreasing linearly to 50 % relative humidity at 40 °C;
- Mains supply voltage fluctuations up to ± 10 % of the nominal voltage;
- Transient overvoltages up to the levels of OVERVOLTAGE CATEGORY II;
- Temporary OVERVOLTAGES occurring on the mains supply;
- Applicable pollution degree of the intended environment (POLLUTION DEGREE 2 in most cases);

SYMBOLS ON UNIT

The following symbols are attached to the unit. The table describes the meaning of the symbols.

	This symbol is attached to covers that access high-voltage electrical components to prevent electric shock. Only a qualified engineer or service personnel should be allowed to open these covers.
	This symbol indicates that caution is required. Refer to product documentation for details.
	This symbol indicates a hot surface.
	This symbol indicates the earth.
	This symbol indicates incorrect usage could lead to a fire hazard.
	This symbol means "ON" for a power switch.
○	This symbol means "OFF" for a power switch.

REFRIGERATOR COMPONENTS

Main body

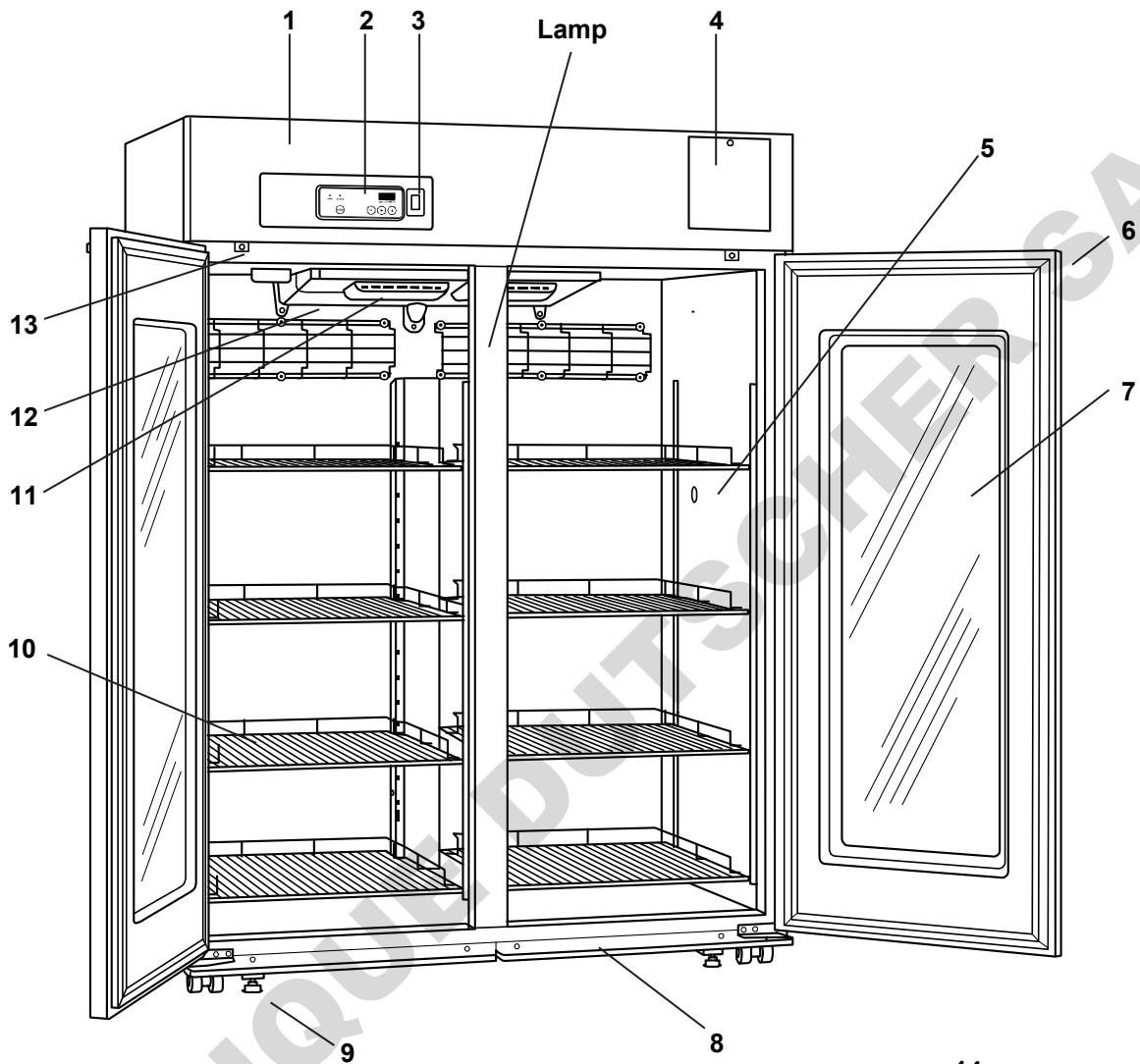

MPR-1412

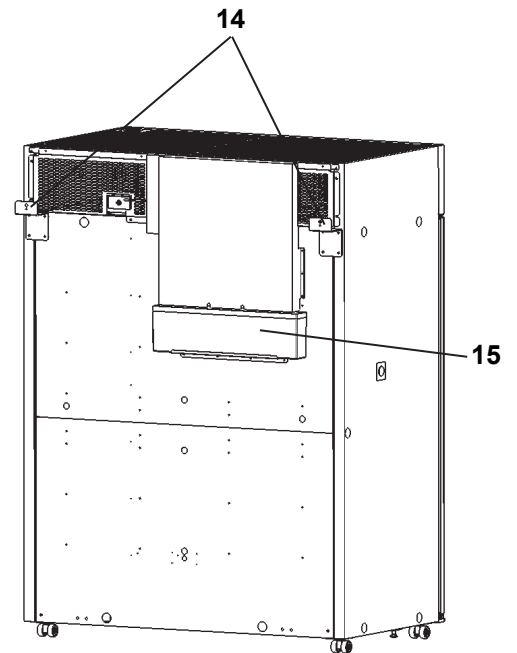

Back side

REFRIGERATOR COMPONENTS

- 1. Front cover:** Open this cover when using the remote alarm terminal or replacing the glow starter [page 13]. To open the cover, pull the lower portion forward.
- 2. Control panel:** The chamber temperature and other alarms/functions can be set through the keys on the control panel. The running status can be checked by the temperature display and indicators [page 12].
- 3. Light switch:** This is a switch to turn on or off the lamp.
- 4. Space for temperature recorder:** A temperature recorder (optional) can be mounted here so that the chamber temperature can be recorded automatically [page 38].
 - ◇Contact our sales representative or agent to arrange the installation.
- 5. Access port:** This port is used to pass the sensor or cable of measuring equipment, or the sensor of a temperature recorder (optional) to the chamber.
 - ◇Replace the insulation and the rubber caps when the access port is not in use. Improper replacement may cause an increase in chamber temperature or condensation around the access port.
- 6. Keyhole:** Turn the key counterclockwise through 180 degree to securely lock the door.
- 7. Glass window:** The condensation may be found on the glass under high temperature and humidity condition. Wipe off the condensation with a soft dry cloth.
- 8. Dew collector:** The condensation on the glass window is accumulated in this dew collector. Wipe off the water from the dew collector with a cloth.
- 9. Leveling foot:** These are screw bolts used to install and fix the unit. Adjust the height of the levelling feet by turning the screw bolts until the two front casters are away from the floor [page 15].
- 10. Shelf (MPR-1412):** The location is selectable. The allowable load is 50 kg per shelf.
 - ◇Never store items on the bottom of the chamber. Always store items in the drawers.
 - Drawer (MPR-1412R):** The allowable load is 40 kg per drawer.
 - <Important>**
Do not pull out plural drawers at the same time when putting in and out of the stored items. If you store heavy objects, it may cause injury due to the fall of the unit.
- 11. Air intake vent:** This is an air intake vent to circulating the air in the chamber. Do not block this vent.
 - ◇Blocking this vent may cause unstable chamber temperature.
 - ◇Do not insert fingers or similar articles into this vent.
- 12. Air exhaust vent:** This is an air exhaust vent to circulating the air in the refrigerator chamber. Do not block this vent.
 - ◇Blocking this vent may cause unstable chamber temperature.
 - ◇Arrange the stored items not to be subjected to the cold air from this vent to avoid freezing.
- 13. Door switch:** This switch detects the door open/close status. The door check indicator is lit when the door is opened.
- 14. Fixture:** Use the fixtures and secure the unit to a wall with a strong rope or chain [page 15].
- 15. Evaporating tray:** Defrost water from the evaporator accumulates on the tray and evaporates into the atmosphere.

REFRIGERATOR COMPONENTS

Control panel

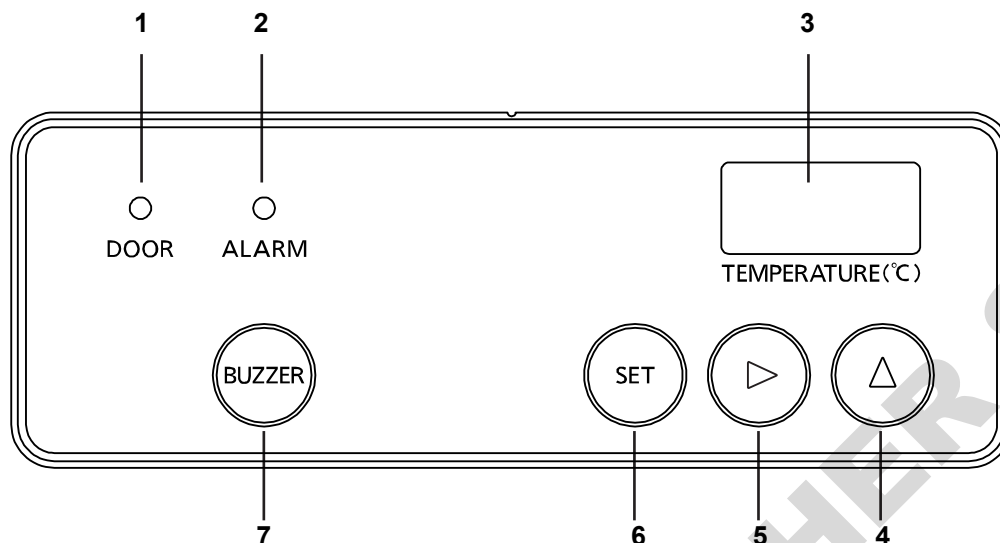

1. Door check indicator (DOOR): The red LED lamp is lit when the door is opened.

✧ 2 minutes after the door check indicator is lit, the buzzer is activated to notice the door opening [page 28].

2. Alarm indicator (ALARM): The red LED lamp blinks during an alarm condition [page 28].

3. Temperature display: Normally shows the present chamber temperature and during an alarm condition, shows a blinking chamber temperature, and an error code and chamber temperature are displayed alternately when the self-diagnostic function activates [page 29].

4. Up arrow key (▲):

At "temperature display mode"; pressing this key for more than 5 seconds leads setting mode [page 21, page 23 to page 26].

At "setting mode"; changes number values between choices [page 21, page 23 to page 26].

At "setting of lock function"; selects ON-OFF of key lock for chamber temperature setting [page 20].

5. Scroll key (▶):

At "temperature display mode"; pressing this key for more than 5 seconds leads "setting of lock function" [page 20].

At "setting mode"; moves the operator through digit on the display.

6. Set key (SET):

At "temperature display mode"; pressing this key leads "chamber temperature setting mode".

At "setting mode"; stores the value into computer memory.

7. Buzzer stop key (BUZZER): Mutes the audible alarm during alarm status .

✧ The alarm status of remote alarm terminal is not cancelled by pressing the alarm buzzer stop key (BUZZER) since the remote alarm is not linked with alarm buzzer (The alarm buzzer is silenced). Refer to "Setting of alarm buzzer link mode" to link the remote alarm terminal with the alarm buzzer.

✧ The audible alarm recovers after certain period (suspended time) if the same alarm status continues [page 26].

✧ "temperature display mode": the status which the temperature display shows the current chamber temperature

✧ "setting mode"; the status which the temperature display is ready to be entered after pressing the set key or up arrow key for 5 seconds.

REFRIGERATOR COMPONENTS

Inside the front cover

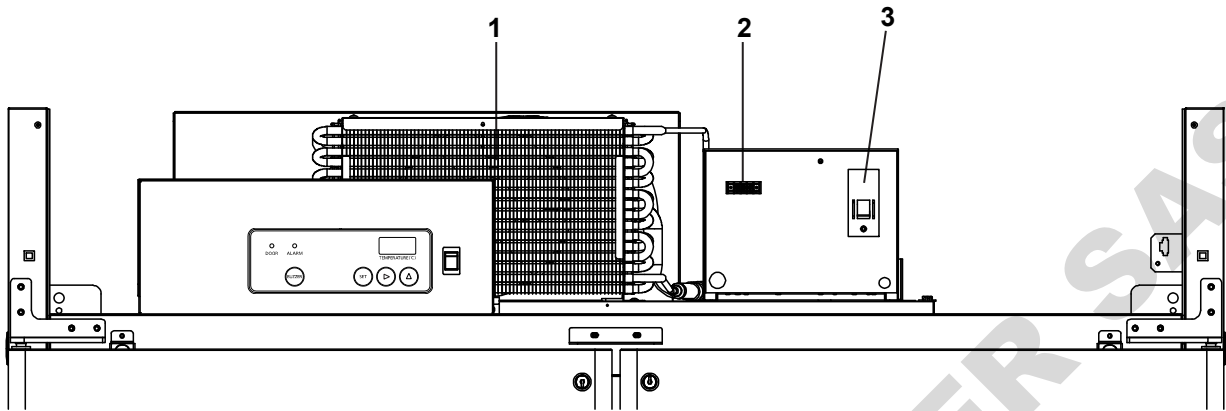

1. Condenser filter

This is a filter for preventing for clogging of the condenser. The clogged filter may cause failure of refrigerating circuit. Clean the filter every 3 months [page 31].

2. Remote alarm terminal

The alarm is relayed to a remote location when a remote alarm device (commercially available) is connected to the remote alarm terminal. Installation of a remote alarm device is recommended when the unit is installed in an unattended location so that the operator of the unit is notified of the alarm. Refer to page 27 for details.

3. Power switch (also functions as a circuit breaker)

This is the power switch of the unit. (ON="|", OFF="o")

◇The round button under the power switch is a test button for the circuit breaker. After pressing this button, the power to the unit is disconnected.

INSTALLATION SITE

This unit must be installed in a location which meets all the conditions described below.

✧ If the unit is installed in a location which does not meet the conditions, its specified performance may not be achieved or malfunctions and accidents may occur.

■ A location not exposed to direct sunlight

Avoid any location which is exposed to direct sunlight. Installing the unit in a location exposed to direct sunlight may reduce its cooling performance.

■ A well-ventilated (airy) location

In order to ensure ventilation, leave clearances of at least 10 cm around the unit (at the left, right, top and back). Blocking the ventilation may reduce the unit's cooling performance or cause malfunctions.

■ A location away from sources of heat

Avoid any location which is close to a major source of heat (such as a heater or boiler). Installing the unit near a major source of heat may reduce the unit's cooling performance.

■ A location with minimal changes in temperature

Avoid any location where the ambient temperature is subject to sudden changes. If the unit is installed in a location where the ambient temperature is subject to sudden changes, it will not be possible to achieve a stable cooling performance.

■ A flat surface where the floor is also capable of bearing the total combined weight (product + optional accessories + stored items)

Install the unit on a flat surface which is even and which is capable of bearing the total combined weight (product + optional accessories + stored items). If the unit is installed where the surface is uneven or where the unit will be inclined at an angle, the unit will be unstable, and accidents or injuries may occur and/or vibration or unnecessary noise may be generated.

■ A location with minimal humidity

Install the unit in a location where the relative humidity is less than 80 %R.H. Installing the unit in a very humid location may cause earth faults and/or electric shock.

■ A location free of flammable or corrosive gases

Avoid any location exposed to flammable or corrosive gases. Flammable or corrosive gases can cause explosions and/or a fire. Furthermore, corrosion of electrical parts may cause insulation to be reduced and result in earth faults and/or electric shock.

■ A location where nothing can fall onto the unit

Avoid locations where objects may fall onto the unit. Objects falling and hitting the unit may cause it to break down or fail.

INSTALLATION

1. Preparations after unpacking

Remove all the tape used to secure the doors and interior parts and leave the doors open for a short while for ventilation.

If any surfaces of the outer cabinet are dirty, wipe the surface using a cloth moistened with a diluted neutral dish-washing detergent.

✧ Using an undiluted solution of detergent may cause the unit's plastic areas to crack. Follow the directions on the detergent for details of dilution.

✧ After wiping the unit using the diluted detergent, be absolutely sure to wipe the surfaces with a cloth dipped in clean water to remove traces of the detergent. After this, be absolutely sure to wipe the surfaces with a dry cloth, allowing the surfaces of the outer cabinet to dry out completely, and then proceed with the installation.

Note:

Remove the cable tie that binds the power supply cord. Prolonged contact with the tie may cause corrosion of the cord coating.

2. Securing and levelling the unit using the levelling feet

Rotate the front levelling feet clockwise until the casters are raised 5 mm to 10 mm above the floor surface [Fig. 1].

In addition, rotate the levelling feet slightly clockwise or anticlockwise, and adjust them so that the unit is completely level.

✧ When the casters are raised from the floor surface, the unit will be secured. If they are left touching the floor, the unit may accidentally move when its door is opened or closed.

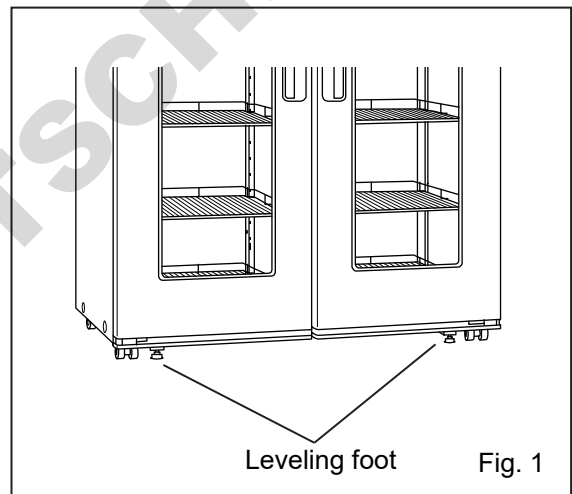

3. Securing the unit by using the fixtures

Use the fixtures on the rear panel of the unit and secure the unit to a wall with a strong rope or chain [Fig. 2].

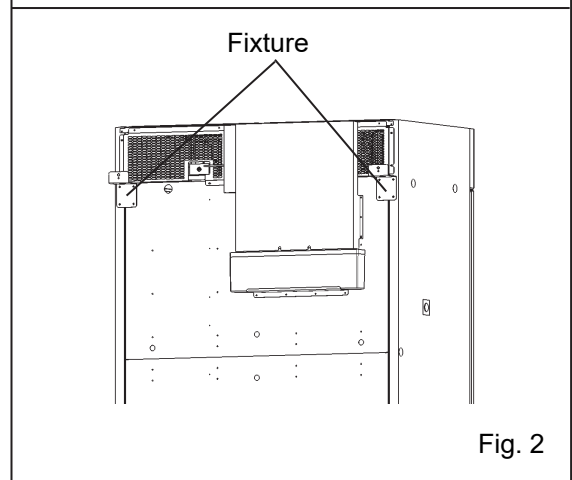

4. Preventing electric shock by earthing the unit

When installing the unit, be absolutely sure to earth (ground) it. Earthing is necessary to prevent electric shocks resulting from deterioration of electrical insulations.

✧ This unit comes with a 3-pin plug having one earth pin. Earthing is not required in the case of a 3-pin power outlet equipped with earth contact.

✧ If the power outlet is not a 3-pin outlet equipped with an earth contact, ask a qualified contractor to do the earthing work.

INSTALLATION

5. Setting up the shelves (MPR-1412)

All shelves are packaged at the bottom of the chamber. Set the shelves firmly in place on the shelf stoppers at the standard locations (4 locations) below.

- 1) The sixth hole under the second screw from the top (top screw) [Fig. 3]
- 2) The first hole under the fifth screw from the top.
- 3) The sixth hole under the seventh screw from the top
- 4) The first hole under the tenth screw from the top.

<Important>

Never put the stored item on the bottom of the chamber. Always put them on the shelf or in the drawer (in the case of MPR1412R).

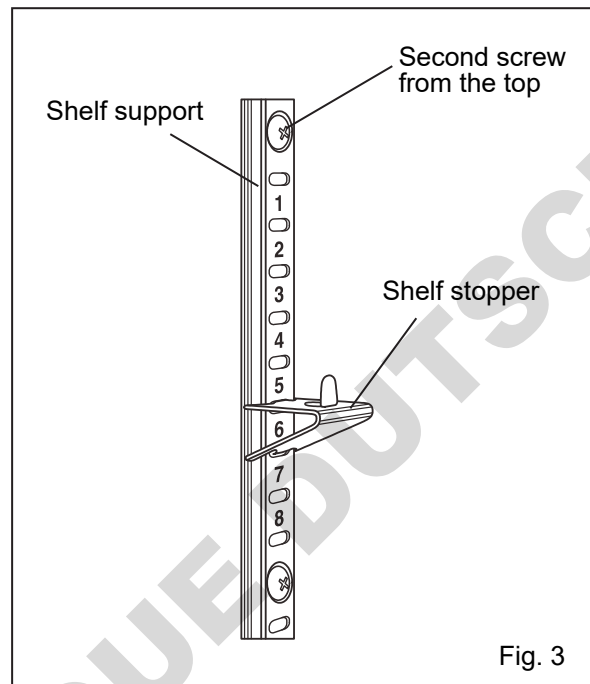

START-UP PROCEDURE

Follow this procedure for the initial operation of the unit and for consequent operations (after temporary stoppage for cleaning, maintenance or moving).

◇ After a power failure, the unit will restart operation automatically with the same settings as before the power failure [page 26].

1. Connect the power supply cord to the dedicated outlet with appropriate rating with the chamber empty.

▶ The alarm indicator and the chamber temperature may blink. And the buzzer may sound. In this case, stop the buzzer by pressing the buzzer stop key (BUZZER). (This is not a malfunction.)

<Important>

If the unit is unplugged or the power to the unit is interrupted, do not restart the unit for at least 5 minutes. This protects the compressor.

Close the door securely. The door check indicator is lit when the door is open. The buzzer activates when the door is opened for more than two minutes. The buzzer is canceled when the door is closed.

2. Allow the chamber temperature to fall to 5 °C (The chamber temperature is set to 5 °C at the factory). Check the chamber temperature on the temperature display.

◇ Allow the chamber temperature to fall to the set temperature when the start-up after cleaning, maintenance or moving.

3. Switch on the light switch to check the lamp is on. After checking, turn off the lamp if the light is not necessary.

4. Set the desired chamber temperature [page 19].

5. When the chamber temperature gets to the set temperature, begin slowly placing items into the chamber to minimize the temperature rise.

<Important>

Always put the stored items on the shelf (MPR-1412) or in the drawer (MPR-1412R), not on the bottom of the chamber. Do not contact the stored items to the chamber walls.

Do not block the air intake vent nor air exhaust vent. Place the stored items with adequate space between them to keep the cool air circulation.

PLACEMENT OF STORED ITEMS

Do not place stored items so as to disrupt the air circulation in the chamber. Disruption of air circulation can cause the freezing of stored items or can impair the temperature distribution in the chamber.

Air intake vent

Do not block the air intake vent with the stored items. Care should be taken not to put any paper or plastic chips near the air intake vent. These may be sucked in and block the air intake vent.

Air exhaust vent

Do not block the air exhaust by the stored items near the air exhaust vent. Care should be taken not to place stored items near to the air exhaust vent. The stored items may become frozen when the refrigerator is operating at temperature settings lower than 5 °C.

Load line [see figure below]

The storage area is limited to ensure adequate air flow in the chamber. The label "load line" is attached to the right and left sides of the chamber. Always place stored items within the area limited by these labels.

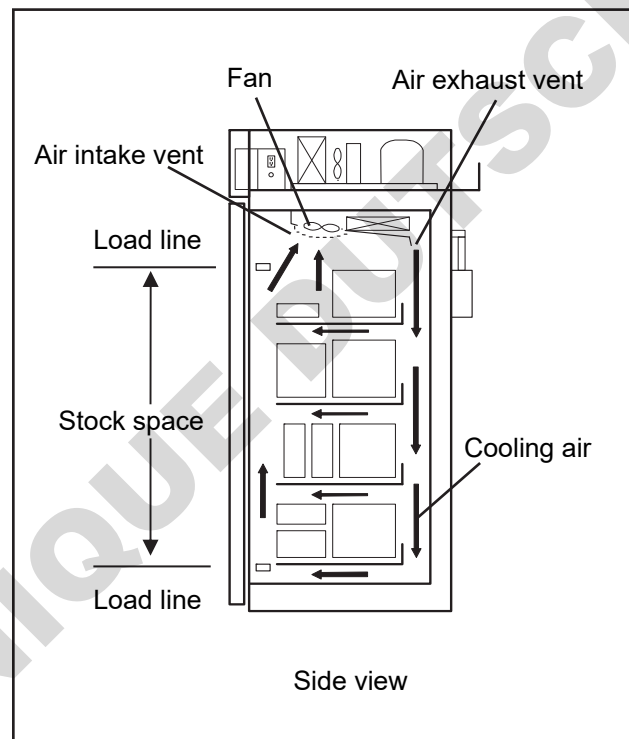

SETTING THE CHAMBER TEMPERATURE

Set the chamber temperature according to the condition of use. This refrigerator can keep the stored items for long period under appropriate temperature.



- Setting range of chamber temperature: between 2 °C and 23 °C
- Initial setting (factory setting): 5 °C

<Important>

The chamber temperature lower than 3 °C may cause partial freeze of stored items.

Example: Change the chamber temperature to 4 °C from 5 °C

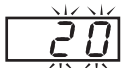
► Following shows a sample setting. Set the desired chamber temperature according to the condition of use.

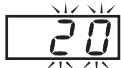
	Operation	Key operated	Display after operation
1	Connect the power supply plug to the dedicated outlet. (only when start-up of unit)	-----	The current chamber temperature blinks. 
2	Press the "set" key.	SET	The current setting (005) is displayed and the first digit blinks. 
3	Press the up arrow key and scroll the figure to 4.	△	The display is changed to 004 from 005. 
4	Press the "set" key.	SET	Set temperature is memorized and the current chamber temperature blinks. 

◇ The unit will return from setting mode to temperature display mode automatically after 90 seconds if no key is operated (auto-return function). In this case, the setting is not changed.

<Attention>

It is recommended to install a temperature recorder (optional component) to check the highest/lowest chamber temperature when the item which needs severe temperature control is stored.





LOCK OF CHAMBER TEMPERATURE SETTING

The chamber temperature setting can be locked to avoid accidental changes. When the lock is ON, a change of chamber temperature setting is not accepted even if the key on the control panel is operated.

- Initial setting (factory setting): lock OFF

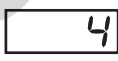
Display	Lock status	Setting of chamber temperature
L 0	Lock OFF	Enabled to change
L 1	Lock ON	Disabled from change

Example: Change the lock to ON from OFF (factory setting)

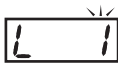
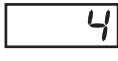
	Operation	Key operated	Display after operation
	-----	-----	The current chamber temperature is displayed. 
1	Press the scroll key for 5 seconds.		The current setting (L 0) is displayed and the first digit blinks. 
2	Press the up arrow key once.		The display is changed to L 1 from L 0. 
3	Press the "set" key.	SET	Lock status is memorized and the current chamber temperature is displayed. 

◇The unit will return from setting mode to temperature display mode automatically after 90 seconds if no key is operated (auto-return function). In this case, the setting is not changed.











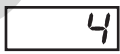

SETTING THE TEMPERATURE DISPLAY MODE

The display mode of chamber temperature is selectable; integer display or decimal display. Select the display mode as required.

- Setting range of temperature display mode: integer mode (display: -50 to 50) or decimal display (display:-19.9 to 50.0)
- Initial setting (factory setting): integer display mode

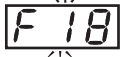
◇In the case of decimal display mode, -19.9 is always displayed when the chamber temperature is lower than -19.9 °C.

Example: Change the mode to decimal display from integer display (factory setting)

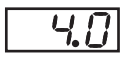
	Operation	Key operated	Display after operation
1	-----	-----	The current chamber temperature is displayed. 
2	Press the up arrow key for 5 seconds.		F00 is displayed and the first digit blinks. 
3	Press the up arrow key 8 times.		The display is changed to F08 from F00. 
4	Press the scroll key once.		The second digit blinks. 
5	Press the up arrow key once.		The display is changed to F18 from F08. 
6	Press the "set" key.	SET	The current setting (000) is displayed and the first digit blinks. 
7	Press the up arrow key and scroll the figure to 1.		The display is changed to 001 from 000. 
8	Press the "set" key.	SET	The setting is memorized and the current chamber temperature is displayed with decimal mode. 

◇The unit will return from setting mode to temperature display mode automatically after 90 seconds if no key is operated (auto-return function). In this case, the setting is not changed.

Note:

Set the figure to 000 in above procedure 7 when selecting the integer display mode.

DEFROSTING THE EVAPORATOR

The following 2 types of defrosting methods is provided for the refrigerator. Both of them are controlled automatically.

■ Cycle defrosting

The refrigerator temperature is kept stable by ON/OFF operation of the compressor. When the compressor is OFF (stopped), the frost on the evaporator is melted by the heater. This defrosting never influences to the refrigerator temperature.

■ Defrosting by defrost sensor

The cycle defrosting may not be sufficient to remove the frost on the evaporator when the ambient temperature is high, the door is opened frequently, or heavy moist items are stored in the refrigerator. In this case, the defrosting operation is started automatically when the defrost sensor detects the frost.

During the defrosting, dF is displayed on the temperature display.

After completion of defrosting, dF display is disappeared and the refrigerator returns to the normal operation.

<Important>

During the defrosting, the refrigerator temperature reaches around 10 °C temporarily.

<Reference>

Too much frost is accumulated on the evaporator when the refrigerator is running under high temperature and humidity condition. For example, the defrosting operation is started once a week when the refrigerator is running with 2 °C setting at 35 °C, 80 %R.H.

SETTING THE ALARM TEMPERATURE





Setting the high-temperature alarm

An abnormality (chamber temperature rise) is indicated by the blinking of red LED lamp and the chamber temperature display and the buzzer sounding (15 minutes after blinking) if the chamber temperature exceeds the set value of the high-temperature alarm. Always set the high-temperature alarm to protect stored items from damage resulting from an increase in temperature.

- Setting range for high-temperature alarm:
between 2 °C and 14 °C higher than the chamber set temperature
- Initial setting (factory setting): 5 °C higher than the chamber set temperature

Example: Change the high temperature alarm to chamber temperature plus 3 °C from chamber temperature plus 5 °C

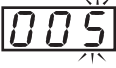
► Following shows a sample setting. Set the desired high-temperature alarm according to the condition of use.

	Operation	Key operated	Display after operation
1	----	----	The current chamber temperature is displayed. 
2	Press the up arrow key for 5 seconds.	△	F00 is displayed and the first digit blinks. 
3	Press the up arrow key once.	△	The display is changed to F01 from F00. 
4	Press the "set" key.	SET	The current setting (005) is displayed and the first digit blinks. 
5	Press the up arrow key and scroll the figure to 3.	△	The display is changed to 003 from 005. 
6	Press the "set" key.	SET	Set temperature is memorized and the current chamber temperature is displayed. 

◇The unit will return from setting mode to temperature display mode automatically after 90 seconds if no key is operated (auto-return function). In this case, the setting is not changed.

<Important>

The high temperature alarm may be activated after defrosting or a large amount of load is stored in the chamber. This is not a malfunction. The high temperature alarm is cancelled automatically when the chamber temperature reaches the set temperature.

ALARM TEMPERATURE SETTING





Setting the low-temperature alarm

An abnormality (chamber temperature drop) is indicated by the blinking of red LED lamp and the chamber temperature display and the buzzer sounding (15 minutes after blinking) if the chamber temperature falls below the set value of low-temperature alarm. Always set the low-temperature alarm to protect stored items from damage resulting from a drop in temperature.

- Setting range for low-temperature alarm:
between 14 °C and 2 °C lower than the chamber set temperature
- Initial setting (factory setting): 5 °C lower than the chamber set temperature

Example: Change the low temperature alarm to chamber temperature minus 3 °C from chamber temperature minus 5 °C

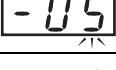
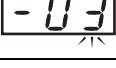
► Following shows a sample setting. Set the desired low-temperature alarm according to the condition of use.

	Operation	Key operated	Display after operation
1	----	----	The current chamber temperature is displayed. 
2	Press the up arrow key for 5 seconds.	△	F00 is displayed and the first digit blinks. 
3	Press the up arrow key twice.	△	The display is changed to F02 from F00. 
4	Press the "set" key.	SET	The current setting (-05) is displayed and the first digit blinks. 
5	Press the up arrow key and scroll the figure to 3.	△	The display is changed to -03 from -05. 
6	Press the "set" key.	SET	Set temperature is memorized and the current chamber temperature is displayed. 

◇The unit will return from setting mode to temperature display mode automatically after 90 seconds if no key is operated (auto-return function). In this case, the setting is not changed.

<Important>

Regardless of the setting of low-temperature alarm, the alarm indicator and the temperature display blink and the buzzer operates if the chamber temperature is lower than 0 °C to prevent the stored items from freezing.

SETTING THE DELAY OF DOOR ALARM





The door check indicator is lit when the door is opened, and the buzzer sounds with some delay to notice the door opening.

The delay time (between lighting of the door check indicator and activation of the buzzer) can be changed. Set an appropriate delay time according to the condition of use to prevent the rise of chamber temperature occurring as a result of the door being left open for too long.

- Setting range of delay time: between 1 and 15 minutes
- Initial setting (factory setting): 2 minutes

Example: Change the delay time to 3 minutes from 2 minutes

► Following shows a sample setting. Set the desired delay time according to the condition of use.

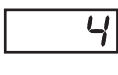
	Operation	Key operated	Display after operation
1	-----	-----	The current chamber temperature is displayed. 
2	Press the up arrow key for 5 seconds.	△	F00 is displayed and the first digit blinks. 
3	Press the up arrow key 4 times.	△	The display is changed to F04 from F00. 
4	Press the "set" key.	SET	The current setting (002) is displayed and the first digit blinks. 
5	Press the up arrow key and scroll the figure to 3.	△	The display is changed to 003 from 002. 
6	Press the "set" key.	SET	Delay time is memorized and the current chamber temperature is displayed. 

◇The unit will return from setting mode to temperature display mode automatically after 90 seconds if no key is operated (auto-return function). In this case, the setting is not changed.

SETTING THE BUZZER SUSPENDED PERIOD

An abnormality is indicated again by the buzzer sounding after a certain period has elapsed (the buzzer recovery time) if the alarm mode continues even after the buzzer has already been silenced by pressing the buzzer stop key (BUZZER). Always set the “buzzer suspended period” to avoid incorrect recognition of alarm mode.

- Setting range of buzzer suspended period:
 - between 10 and 60 minutes in 10-minute intervals (display of setting: between 010 and 060) or no recovery (display of setting; 000)
- Initial setting (factory setting): 30 minutes (display of setting: 030)

The buzzer does not sound again when the setting is 000. However, the buzzer will operate if other alarm status is detected.

Example: Change the buzzer suspended time to 20 minutes from 30 minutes

► Following shows a sample setting. Set the desired suspended time according to the condition of use.

	Operation	Key operated	Display after operation
1	-----	-----	The current chamber temperature is displayed.
2	Press the up arrow key for 5 seconds.		F00 is displayed and the first digit blinks.
3	Press the up arrow key 5 times.		The display is changed to F05 from F00.
4	Press the scroll key once.		The second digit blinks.
5	Press the up arrow key twice.		The display is changed to F25 from F05.
6	Press the “set” key.	SET	The current setting (030) is displayed and the second digit blinks.
7	Press the up arrow key and scroll the figure to 2.		The display is changed to 020 from 030.
8	Press the “set” key.	SET	Suspended time is memorized and the current chamber temperature is displayed.

◇The unit will return from setting mode to temperature display mode automatically after 90 seconds if no key is operated (auto-return function). In this case, the setting is not changed.

◇The setting should be performed during normal operation, not during alarm status.

OPERATION CHECK AFTER RECOVERY

After recovery from a power failure, the unit will resume operation automatically with the setting before power failure. Accordingly, there is no need for re-set, however, always check the running status after recovery.

◇The set value is memorized by nonvolatile memory during power failure.

REMOTE ALARM TERMINAL

The alarm status is noticed to a remote location when a remote alarm equipment (commercial item) is connected to the remote alarm terminal. It is recommended to install remote alarm equipment (commercial item) when the refrigerator is installed in a desolate location so that an alarm status is noticed to an operator.

◇ Contact our representative or agent for the installation of remote alarm equipment (commercial item).

■ Location of remote alarm terminal: inside the front cover [page 13]

■ Allowable contact capacity: DC 30 V, 2 A

Contact output:

Connection	Normal status	Abnormal status
Between COM. and N.O.	open	closed
Between COM. and N.C.	closed	open

The alarm status of remote alarm terminal is not cancelled by pressing the alarm buzzer stop key (BUZZER) since the remote alarm is not linked with alarm buzzer (The alarm buzzer is silenced). Refer to "Setting of alarm buzzer link mode" to link the remote alarm terminal with the alarm buzzer.

However, the alarm status of remote alarm terminal is not cancelled by pressing the buzzer stop key (BUZZER) when the unit is under power failure alarm (with MPR-48B1 installed).

The remote alarm terminal is in alarm status when the power supply cord is unplugged because it is regarded as a power failure.

◇ It is recommended to use cables with a maximum length of 30 meters.

◇ Use shielded wire for the connection.







SETTING OF ALARM BUZZER LINK MODE

The operation of remote alarm when pressing alarm buzzer stop key (BUZZER) is selectable; link to the alarm buzzer or not link to the alarm buzzer.

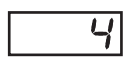
■ Initial setting (factory setting): not link to the alarm buzzer (display of setting:000)

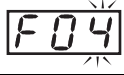
Display	Operation of remote alarm	When pressing alarm buzzer stop key (BUZZER)
000	Not link to alarm buzzer	Alarm buzzer is silenced.
001	Link to alarm buzzer	Alarm buzzer is silenced, and remote alarm is canceled.

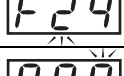
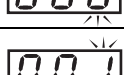
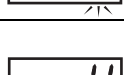
Example: Change the link mode to linked from not linked to alarm buzzer (factory setting)

	Description of operation	Key operated	Indication after operation
1		----	The current chamber temperature is displayed. 
2	Press up arrow key for 5 seconds.	△	F00 is displayed and the first digit blinks. 
3	Press up arrow key 4 times.	△	The display is changed to F04 from F00. 
4	Press scroll key once.	▷	The second digit blinks. 
5	Press up arrow key twice.	△	The display is changed to F24 from F04. 
6	Press set key.	SET	The current setting (000) is displayed and the first digit blinks. 
7	Press up arrow key and scroll the figure to 1.	△	The display is changed to 001 from 000. 
8	Press set key.	SET	The setting is memorized and the current chamber temperature is displayed. 

◇ The setting mode returns to the temperature display mode automatically when 90 seconds has passed without any key operation (auto-return function). In this case, the setting is not accepted.

ALARM FUNCTIONS

This unit has the alarms functions listed below.

Contact our sales representative or agent if the alarm is not resolved by eliminating the following causes.

Before calling for service, take some precautions to prevent the stored items (for example by transferring the items to another freezer).

Alarms	Cause	Indication	Buzzer	Remote alarm
High- temperature alarm	The chamber temperature is higher than the setting of the high-temperature alarm. [page 23]	The alarm indicator blinks. The chamber temp. blinks.	Intermittent tone with 15 minutes delay.	Alarm mode with 15 minutes delay.
Air circulation alarm	The chamber temperature distribution gets worse	The alarm indicator blinks. The chamber temp. blinks.	Intermittent tone with 15 minutes delay.	Alarm mode with 15 minutes delay.
Low- temperature alarm	The chamber temperature is lower than the setting of the low-temperature alarm. [page 24]	The alarm indicator blinks. The chamber temp. blinks.	Intermittent tone with 15 minutes delay.	Alarm mode with 15 minutes delay.
0 °C alarm	The chamber temperature is lower than 0 °C	The alarm indicator blinks. The chamber temp. blinks.	Intermittent tone	Alarm mode.
Power failure alarm	A power failure has occurred. The power supply cord is disconnected.	-----	-----	Alarm mode.
Power failure alarm (with MPR-48B1)	A power failure has occurred. The power supply cord is disconnected.	The alarm indicator blinks.	Intermittent tone	Alarm mode.
Door alarm	The door is open.	The door check indicator blinks.	Intermittent tone with 2 minutes delay.	-----

◇ The alarm status of remote alarm terminal is not cancelled by pressing the alarm buzzer stop key (BUZZER) since the remote alarm is not linked with alarm buzzer (The alarm buzzer is silenced). Refer to "Setting of alarm buzzer link mode" to link the remote alarm terminal with the alarm buzzer.

Air circulation alarm

The alarm indicator blinks and the buzzer sounds (after 15 minutes) when the sensor detects that the chamber temperature distribution is getting worse extremely. This may be caused by the block of cold air in the chamber due to the frost on the evaporator or stop of cooling fan motor.

◇The air circulation is detected by the exclusive alarm sensor attached to the center of the chamber.

SAFETY FUNCTIONS

This unit has the safety functions listed below.

Safety	Cause	Indication, Buzzer	Safety operation
Over-heat protection	When the chamber temp. is higher than about 30 °C.	-----	The heaters are OFF. Fan motor for cold air circulation is OFF and reset when the chamber temp. is lower than about 25 °C.
Over-cool protection	When the chamber temp. is lower than about -1 °C.	-----	Compressor is OFF and reset when the chamber temp. is higher than about 6 °C.
Auto-return	When there is no key pressing in setting mode for 90 seconds.	-----	Finishing of setting mode and returning to temp. display mode.
Key lock	When the key lock is ON (L1).	----	Change of chamber temp. setting is disabled.

SELF-DIAGNOSTIC FUNCTIONS

Alarms involving an error code indicated on the temperature display are generated by the unit's self-diagnostic function.

If any of the error codes are displayed, contact our sales representative or agent without delay, report the error code, and request repairs.

Self-diagnostic	Cause	Indication	Buzzer	Remote alarm
Sensor abnormality	The thermal sensor is disconnected.	Alarm indicator blinks. E01 and -50 are displayed alternately.	Intermittent tone	Alarm mode
	The thermal sensor is short-circuited.	Alarm indicator blinks. E02 and 50 are displayed alternately.		
	The defrost sensor is disconnected.	Alarm indicator blinks. E03 and chamber temp. are displayed alternately.		
	The defrost sensor is short-circuited.	Alarm indicator blinks. E04 and chamber temp. are displayed alternately.		
	The compressor sensor is disconnected.	Alarm indicator blinks. E05 and chamber temp. are displayed alternately.		
	The compressor sensor is short-circuited.	Alarm indicator blinks. E06 and chamber temp. are displayed alternately.		
	The exclusive alarm sensor is disconnected.	Alarm indicator blinks. E13 and chamber temp. are displayed alternately.		
	The exclusive alarm sensor is short-circuited.	Alarm indicator blinks. E14 and chamber temp. are displayed alternately.		
Battery switch check (with MPR-48B1)	When the battery switch is turned ON without setting after attachment.	E09 and chamber temp. are displayed alternately.	Intermittent tone	----
Compressor temperature abnormality	The fan motor for cooling the compressor is faulty.	Alarm indicator blinks. E10 and chamber temp. are displayed alternately.	Intermittent tone	Alarm mode
Battery check (with MPR-48B1)	When about 3 years have passed with the power supply cord connected to the outlet. (time to replace the battery)	F-1 and chamber temp. are displayed alternately.	----	----
Fan motor check	When about 6 years have passed with the power supply cord connected to the outlet. (time to replace the fan motor)	F-2 and chamber temp. are displayed alternately.	----	----

◇ The alarm status of remote alarm terminal is not cancelled by pressing the alarm buzzer stop key (BUZZER) since the remote alarm is not linked with alarm buzzer (The alarm buzzer is silenced). Refer to "Setting of alarm buzzer link mode" to link the remote alarm terminal with the alarm buzzer.

ROUTINE MAINTENANCE

Cleaning of exterior, interior, and accessories

Use a dry cloth to wipe down the outside and inside of the unit and all accessories. If the outside panels are dirty, clean them with a diluted neutral dish-washing detergent.

Wipe off condensation from the exterior of the cabinet or glass with a dry, soft cloth.

✧ Using an undiluted solution of detergent may cause the unit's plastic areas to crack. Follow the directions on the detergent for details of dilution.

✧ After wiping the cabinet or accessories with a diluted detergent, be absolutely sure to wipe the surfaces with a cloth dipped in clean water to remove traces of the detergent. After this, be absolutely sure to wipe the surfaces with a dry cloth.

<Important>

Never pour water onto or into the unit. This may cause electric shock or failure.

Do not use a brush, an acid, a thinner, laundry soap, a powder detergent, or boiling water for cleaning. These may cause damage to painted surfaces or cause perishing of plastic and rubber components. Moreover, do not wipe plastic and rubber components with volatile material.

Cleaning of evaporating tray

The evaporation tray is located at the back side. Cleaning the evaporating tray twice or three times per year is recommended.

Consult our sales representative or agent when cleaning the evaporating tray.

ROUTINE MAINTENANCE

Cleaning of condenser filter

The filter preventing for clogging of the condenser is attached inside the front cover [Fig. 1]. The clogged filter may cause failure of refrigerating circuit. Clean the filter every 3 months.

1. Lift the condenser filter by using the black lug and then pull toward to remove the condenser filter.
2. Clean the condenser filter using a vacuum cleaner or wash the condenser filter with water.
3. Dry the condenser filter if it is washed with water.
4. Replace the condenser filter.

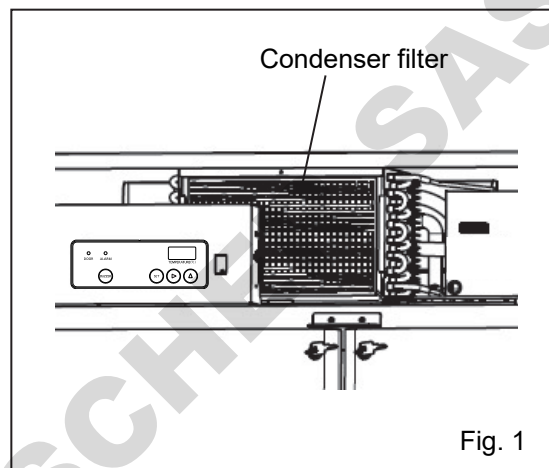

Fig. 1

DOMINIQUE DUTSCHER SAS

TROUBLESHOOTING

If the unit malfunctions, check out the following before calling for service.

<Attention>

If the malfunction is not resolved after checking the following items or if the malfunction is not shown in the table below, contact our sales representative or agent.

Malfunction	Check/Remedy
Nothing operates even when the power supply plug is plugged in	<ul style="list-style-type: none"> <input type="checkbox"/> The unit is not connected to the power supply properly. <input type="checkbox"/> The capacity and voltage of power supply is not sufficient. <input type="checkbox"/> There is a power failure. <input type="checkbox"/> The circuit breaker on the supply circuit is activated. <input type="checkbox"/> The fuse on the supply circuit is blown.
The alarm is activated at start-up	<ul style="list-style-type: none"> ↯ The alarm status is kept until the chamber temperature reaches the set temperature.
The alarm is activated during operation	<ul style="list-style-type: none"> <input type="checkbox"/> The unit is not connected to the power supply properly. <input type="checkbox"/> The capacity and voltage of power supply is not sufficient. <input type="checkbox"/> There is a power failure. <input type="checkbox"/> The circuit breaker on the supply circuit is activated. <input type="checkbox"/> The fuse on the supply circuit is blown. <input type="checkbox"/> The chamber temperature setting was changed. <input type="checkbox"/> The door was kept opened for a long time. <input type="checkbox"/> The containers of high temperature (load) were put in the chamber. <input type="checkbox"/> The door is opened.
No key operation is available	<ul style="list-style-type: none"> <input type="checkbox"/> The key lock is set in ON (L 1). → Set the key lock in OFF (L 0).
During the setting mode, the mode returns to the temperature display mode	<ul style="list-style-type: none"> ↯ The setting mode returns to the temperature display mode automatically when 90 seconds has passed without any key operation (auto-return function).
Noisy	<ul style="list-style-type: none"> <input type="checkbox"/> The floor is not sturdy. <input type="checkbox"/> The installation site is not level. <input type="checkbox"/> The refrigerator is tilted. <input type="checkbox"/> The cabinet contacts the surrounding wall. <input type="checkbox"/> The installation of the evaporating tray or unit cover is improper.
The chamber does not get cold enough	<ul style="list-style-type: none"> <input type="checkbox"/> A large amount of items or warm product was put in the chamber. <input type="checkbox"/> The door is frequently opened. <input type="checkbox"/> The chamber temperature setting is high. <input type="checkbox"/> The unit is in direct sunlight. <input type="checkbox"/> The unit is not installed in the installation site specified in this manual. <input type="checkbox"/> The ventilation around the unit is blocked. <input type="checkbox"/> There is a nearby heat source. <input type="checkbox"/> The ambient temperature is too high. → The allowable ambient temperature is between -5 °C and 35 °C. <input type="checkbox"/> The stored items is too much. <input type="checkbox"/> The air exhaust vent is blocked up with containers. <input type="checkbox"/> The access port is not covered. → The access port should be covered with the insulation and rubber caps when no use. <input type="checkbox"/> The door seal is damaged. → If it is damaged, contact our sales representative or agent for replacement. <input type="checkbox"/> Any foreign substance is located between door gaskets.

DISPOSAL OF UNIT

WARNING

- If the unit is to be stored unused in an unsupervised area for an extended period, **ensure that children do not have access and doors cannot be closed completely.**
- **The disposal of the unit should be accomplished by appropriate personnel. Always remove doors** to prevent accidents such as suffocation.
- **The unit contains flammable refrigerant and flammable blowing gas. When the unit is disassembled or disposed of, the work must be performed in a well-ventilated place and avoid the place near fire.** It may cause explosions and/or a fire in case of refrigerant or gas leakage.

Decontamination of unit

Before disposal of unit with biohazardous danger, decontaminate the unit to the extent possible by the user.

Refrigerant (applicable to MPR-1412-PE and MPR-1412R-PE)

REGULATION (EU) 2024/573 on Certain Fluorinated Greenhouse Gases

This product contains fluorinated greenhouse gases as refrigerant.

Refrigerant	GWP	Refrigerant (net) (kg)	Weight of CO ₂ equivalent (tonne)
R-1234yf	0.501	0.280	0.00014

DISPOSAL OF UNIT

Information on Disposal for Users of Waste Electrical & Electronic Equipment (private households)



This symbol on the products and/or accompanying documents means that used electrical and electronic products should not be mixed with general household waste.

For proper treatment, recovery and recycling, please take these products to designated collection points, where they will be accepted on a free of charge basis. Alternatively, in some countries you may be able to return your products to your local retailer upon the purchase of an equivalent new product.

Disposing of this product correctly will help to save valuable resources and prevent any potential negative effects on human

health and the environment which could otherwise arise from inappropriate waste handling. Please contact your local authority for further details of your nearest designated collection point.

Penalties may be applicable for incorrect disposal of this waste, in accordance with national legislation.

For business users in the European Union

If you wish to discard electrical and electronic equipment, please contact your dealer or supplier for further information.

Information on Disposal in other Countries outside the European Union

This symbol is only valid in the European Union.

If you wish to discard this product, please contact your local authorities or dealer and ask for the correct method of disposal.

Benutzerinformationen zur Entsorgung von elektrischen und elektronischen Geräten (private Haushalte)



Dieses Symbol auf Produkten und/oder begleitenden Dokumenten bedeutet, dass verbrauchte elektrische und elektronische Produkte nicht mit gewöhnlichem Haushaltsabfall vermischt werden sollen.

Bringen Sie zur ordnungsgemäßen Behandlung, Rückgewinnung und Recycling diese Produkte zu den entsprechenden Sammelstellen, wo sie ohne Gebühren entgegengenommen werden. In einigen Ländern kann es auch möglich sein, diese Produkte beim Kauf eines entsprechenden neuen Produkts bei Ihrem örtlichen Einzelhändler abzugeben.

Die ordnungsgemäße Entsorgung dieses Produkts dient dem Umweltschutz und verhindert mögliche schädliche Auswirkungen auf Mensch und Umgebung, die aus einer unsachgemäßen Handhabung von Abfall entstehen können. Genauere Informationen zur nächstgelegenen Sammelstelle erhalten Sie bei Ihrer Gemeindeverwaltung.

In Übereinstimmung mit der Landesgesetzgebung können für die unsachgemäße Entsorgung dieser Art von Abfall Strafbußhöhen erhoben werden.

Für Geschäftskunden in der Europäischen Union

Bitte treten Sie mit Ihrem Händler oder Lieferanten in Kontakt, wenn Sie elektrische und elektronische Geräte entsorgen möchten. Er hält weitere Informationen für sie bereit.

Informationen zur Entsorgung in anderen Ländern außerhalb der Europäischen Union

Dieses Symbol ist nur in der Europäischen Union gültig.

Bitte treten Sie mit Ihrer Gemeindeverwaltung oder Ihrem Händler in Kontakt, wenn Sie dieses Produkt entsorgen möchten, und fragen Sie nach einer Entsorgungsmöglichkeit.

Tájékoztató az elektromos és elektronikus berendezések hulladékainak ártalmatlanításáról (háztartások)



Ha ez a szimbólum szerepel a termékeken és/vagy a mellékelt dokumentumokon, az elhasznált elektromos és elektronikus termékeket nem szabad keverni az általános háztartási szeméttel.

A megfelelő kezelés, visszanyerés és újrahaznosítás érdekében kérjük, szállítsák az ilyen termékeket a kijelölt gyűjtőhelyekre, ahol térítésmentesen átveszik azokat. Más lehetőségként bizonyos országokban a termékeket a helyi kiskereskedője is visszaveheti, amennyiben hasonló, új terméket vásárol.

A termék megfelelő ártalmatlanításával segít megőrizni az értékes erőforrásokat és megelőzheti a környezetre és az egészségre esetleg ártalmas hatásokat, amelyeket a hulladékok helytelen kezelése egyébként okozhat. Kérjük, lépjen kapcsolatba a helyi hatósággal további információért a legközelebbi kijelölt begyűjtő hely fellelhetőségét illetően.

A nemzeti törvények értelmében az ilyen hulladék helytelen ártalmatlanítása esetén büntetést szabhatnak ki. Amennyiben a használt termék elemet vagy akkumulátort tartalmaz, kérjük, a helyi környezetvédelmi előírások betartásával, külön ártalmatlanítsa ezeket.

Üzleti felhasználók az Európai Unióban

Amennyiben elektromos vagy elektronikus berendezést kíván ártalmatlanítani, kérjük, lépjen kapcsolatba kereskedőjével vagy szállítójával további információkért.

Tájékoztató az ártalmatlanítással kapcsolatban az Európai Unión kívüli országok esetében

Ez a szimbólum csak az Európai Unióban érvényes.

Amennyiben ezt a terméket kívánja ártalmatlanítani, kérjük, lépjen kapcsolatba a helyi hatósággal, illetve kereskedőjével, és érdeklődjön az ártalmatlanítás megfelelő módjáról.

Указания за изхвърляне на електрически и електронни отпадъци (за битови потребители)



Този символ върху изделия и-или в придружаваща документация означава, че електрически и електронни отпадъци не бива да се изхвърлят в общ контейнер.

Моля, да предавате тези отпадъци в пунктовете за вторични суровини, където ги приемат безплатно, за понататъшна обработка и рециклиране. В някои страни те могат да бъдат върнати на търговците на дребно, от които са купени, срещу закупуване на нови подобни изделия.

Правилното съхраняване и обработка на такива отпадъци спестява ценни ресурси и предпазва от негативно влияние

върху здравето на хората и околната среда. За по-подробна информация относно пунктовете за вторични суровини се обърнете към местните органи.

Националните законодателства на някои страни предвиждат глоби за неправилно изхвърляне на отпадъци.

За промишлени потребители от Европейския съюз

Повече информация за изхвърляне на електрически и електронни отпадъци можете да получите от съответния доставчик или дилър.

За потребители от страните извън Европейския съюз

Този символ е валиден само в Европейския съюз.

За информация относно правилно изхвърляне на такива отпадъци потърсете местните органи на властта или дилъра си.

Πληροφορίες για την απόρριψη ηλεκτρικών και ηλεκτρονικών συσκευών (οικιακής χρήσης)



Αυτή η σήμανση στα προϊόντα και/ή στα συνοδευτικά τους έντυπα υποδηλώνει ότι τα εν λόγω ηλεκτρικά και ηλεκτρονικά προϊόντα δεν πρέπει να απορριφθούν μαζί με οικιακά απορρίμματα.

Προκειμένου να πραγματοποιηθεί η κατάλληλη επεξεργασία και ανακύκλωση, αποσύρете αυτά τα προϊόντα σε ανάλογα σημεία περισυλλογής, όπου θα γίνουν δεκτά χωρίς χρέωση σας. Εναλλακτικά, σε ορισμένες χώρες, μπορείτε να επιστρέψετε τα προϊόντα σε τοπικά καταστήματα με σκοπό την αγορά ανάλογου νέου προϊόντος.

Η ορθή απόρριψη αυτού του προϊόντος βοηθάει στην εξοικονόμηση πολύτιμων φυσικών πόρων και στην αποφυγή τυχόν αρνητικών επιπτώσεων για την ανθρώπινη υγεία και το περιβάλλον, οι οποίες μπορεί να προκληθούν από λανθασμένη διαχείριση του εν λόγω απορρίμματος. Επικοινωνήστε με τις τοπικές αρχές για περισσότερες πληροφορίες σχετικά με το πλησιέστερο ανάλογο σημείο περισυλλογής.

Ενδέχεται να επιβληθούν κυρώσεις για λανθασμένη απόρριψη του εν λόγω προϊόντος, σύμφωνα με τη νομοθεσία της χώρας σας.

Προϊόντα επαγγελματικής χρήσης, Ευρωπαϊκή Ένωση

Αν επιθυμείτε να απορρίψετε ηλεκτρικό και ηλεκτρονικό εξοπλισμό, επικοινωνήστε με τον πωλητή ή τον προμηθευτή για περισσότερες πληροφορίες.

Πληροφορίες για την απόρριψη ηλεκτρικών και ηλεκτρονικών συσκευών σε χώρες εκτός της Ευρωπαϊκής Ένωσης

Αυτή η σήμανση ισχύει μόνο στην Ευρωπαϊκή Ένωση.

Αν επιθυμείτε να απορρίψετε αυτό το προϊόν, επικοινωνήστε με τις τοπικές αρχές ή καταστήματα πώλησης για να πληροφορηθείτε σχετικά με την ορθή διαδικασία απόρριψης.

Informations relatives à l'évacuation des déchets, destinées aux utilisateurs d'appareils électriques et électroniques (appareils ménagers domestiques)



Lorsque ce symbole figure sur les produits et/ou les documents qui les accompagnent, cela signifie que les appareils électriques et électroniques ne doivent pas être jetés avec les ordures ménagères.

Pour que ces produits subissent un traitement, une récupération et un recyclage appropriés, envoyez-les dans les points de collecte désignés, où ils peuvent être déposés gratuitement. Dans certains pays, il est possible de renvoyer les produits au revendeur local en cas d'achat d'un produit équivalent.

En éliminant correctement ce produit, vous contribuerez à la conservation des ressources vitales et à la prévention des éventuels effets négatifs sur l'environnement et la santé humaine qui pourraient survenir dans le cas contraire.

Afin de connaître le point de collecte le plus proche, veuillez contacter vos autorités locales.

Des sanctions peuvent être appliquées en cas d'élimination incorrecte de ces déchets, conformément à la législation nationale.

Utilisateurs professionnels de l'Union européenne

Pour en savoir plus sur l'élimination des appareils électriques et électroniques, contactez votre revendeur ou fournisseur.

Informations sur l'évacuation des déchets dans les pays ne faisant pas partie de l'Union européenne

Ce symbole n'est reconnu que dans l'Union européenne.

Pour vous débarrasser de ce produit, veuillez contacter les autorités locales ou votre revendeur afin de connaître la procédure d'élimination à suivre.

DISPOSAL OF UNIT

Oplysninger til brugerne om afhændelse af elektriske apparater og elektronisk udstyr (private husholdninger)



Når produkter og/eller medfølgende dokumenter indeholder dette symbol, betyder det, at elektriske apparater og elektronisk udstyr ikke må smides ud sammen med det almindelige husholdningsaffald.

For at sikre en korrekt behandling, indsamling og genbrug, skal du aflevere disse produkter på dertil indrettede indsamlingssteder, hvor de vil blive modtaget uden ekstra omkostninger. I nogle lande er der også mulighed for, at du kan indlevere dine produkter hos den lokale forhandler, hvis du køber et nyt og tilsvarende produkt.

Hvis du afhænder dette produkt på korrekt vis, vil det være med at spare på de værdifulde naturlige råstoffer og forhindre eventuelle negative påvirkninger på folkesundheden og miljøet, hvilket ellers kunne blive følgerne af en forkert håndtering af affaldet. Kontakt de lokale myndigheder for at få yderligere oplysninger om, hvor du kan finde det nærmeste indsamlingssted.

I visse lande vil en forkert afhændelse af affaldet medføre en bødestraf i henhold til de gældende bestemmelser på området.

Professionelle brugere i EU

Hvis du ønsker at smide elektriske apparater eller elektronisk udstyr ud, skal du kontakte din forhandler eller leverandør for at få yderligere oplysninger.

Oplysninger om afhændelse i lande uden for EU

Dette symbol er kun gyldigt i EU.

Hvis du ønsker at afhænde dette produkt, skal du rette henvendelse til de lokale myndigheder eller din forhandler. Her kan du få oplysninger om, hvordan du bedst kommer af med produktet.

Información sobre la eliminación para los usuarios de equipos eléctricos y electrónicos usados (particulares)



La aparición de este símbolo en un producto y/o en la documentación adjunta indica que los productos eléctricos y electrónicos usados no deben mezclarse con la basura doméstica general.

Para que estos productos se sometan a un proceso adecuado de tratamiento, recuperación y reciclaje, llévelos a los puntos de recogida designados, donde los admitirán sin coste alguno. En algunos países existe también la posibilidad de devolver los productos a su minorista local al comprar un producto nuevo equivalente.

Si desecha el producto correctamente, estará contribuyendo a preservar valiosos recursos y a evitar cualquier posible efecto negativo en la salud de las personas y en el medio ambiente que pudiera producirse debido al tratamiento inadecuado de desechos. Póngase en contacto con su autoridad local para que le informen detalladamente sobre el punto de recogida designado más cercano.

De acuerdo con la legislación nacional, podrían aplicarse multas por la eliminación incorrecta de estos desechos.

Para empresas de la Unión Europea

Si desea desechar equipos eléctricos y electrónicos, póngase en contacto con su distribuidor o proveedor para que le informe detalladamente.

Información sobre la eliminación en otros países no pertenecientes a la Unión Europea

Este símbolo sólo es válido en la Unión Europea.

Si desea desechar este producto, póngase en contacto con las autoridades locales o con su distribuidor para que le informen sobre el método correcto de eliminación.

Informácie pre užívateľov o likvidácii použitého elektrického a elektronického zariadenia (súkromné domácnosti)



Tento symbol na produktoch a/alebo na priložených dokumentoch znamená, že použité elektrické a elektronické zariadenia sa nesmú miešať so všeobecným domácim odpadom.

Pre správne zaobchádzanie, obnovu a recykláciu, odveďte prosím tieto produkty na určené zberné miesta, kde budú prijaté bez poplatku. V niektorých krajinách je možné tieto produkty vrátiť priamo miestnemu maloobchodu v prípade, ak si objednáte podobný nový výrobok.

Správna likvidácia týchto produktov pomôže ušetriť hodnotné zdroje a zabrániť možným negatívnym vplyvom na ľudské zdravie a prostredie, ktoré môžu vzniknúť z nesprávneho zaobchádzania s odpadom. Pre bližšie informácie o vašom najbližšom zbernom mieste kontaktujte, prosím, vaše miestne úrady.

V prípade nesprávnej likvidácie odpadu môžu byť uplatnené pokuty v súlade so štátnou legislatívou.

Pre právnické osoby v Európskej únii

Ak potrebujete zlikvidovať opotrebované elektrické a elektronické produkty, pre bližšie informácie kontaktujte, prosím, svojho miestneho predajcu alebo dodávateľa.

Informácie o likvidácii elektrického a elektronického odpadu v krajinách mimo Európskej únie

Tento symbol je platný iba v Európskej únii.

Ak si prajete zlikvidovať tento produkt, pre bližšie informácie kontaktujte, prosím, vaše miestne úrady alebo predajcu a informujte sa o správnej metóde likvidácie.

Informații pentru utilizatori, privind eliminarea echipamentelor electrice și electronice uzate (proprietate particulară)



Acest simbol, de pe produse și/sau documentele însoțitoare, are semnificația că produsele electrice și electronice uzate nu trebuie amestecate cu deșeurile menajere generale.

În scopul aplicării unui tratament corespunzător, recuperării și reciclării, vă rugăm să predați aceste produse la punctele de colectare desemnate, unde vor fi acceptate gratuit. Ca o alternativă, în unele țări, există posibilitatea să returnați produsele dumneavoastră uzate furnizorului cu amănuntul, în momentul achiziționării unui produs echivalent nou.

Eliminarea corectă a acestor produse uzate va ajuta la economisirea unor resurse valoroase și la prevenirea oricăror efecte potențial negative asupra sănătății umane și a mediului înconjurător, care, în caz contrar ar putea fi cauzate prin manipularea necorespunzătoare a deșeurilor. Pentru mai multe detalii privind cele mai apropiate puncte de colectare, vă rugăm să contactați autoritățile locale.

Pentru eliminarea incorectă a acestui tip de deșeuri se pot aplica amenzi, în conformitate cu legislația națională.

Pentru utilizatorii comerciali din Uniunea Europeană

Dacă doriți să vă debarașiți de echipamente electrice și electronice, vă rugăm să contactați distribuitorul sau furnizorul dumneavoastră, pentru mai multe informații.

Informații privind eliminarea deșeurilor în țările din afara Uniunii Europene

Acest simbol este valabil numai în Uniunea Europeană.

Dacă doriți să eliminați acest tip de produse uzate, vă rugăm să contactați autoritățile locale sau distribuitorul și să aflați metoda corectă de eliminare.

Informacja dla użytkowników o pozbywaniu się urządzeń elektrycznych i elektronicznych (dotyczy gospodarstw domowych)



Przedstawiony symbol umieszczony na produktach lub dołączonej do nich dokumentacji informuje, że niesprawnych urządzeń elektrycznych lub elektronicznych nie można wyrzucać razem z odpadami gospodarczymi.

Prawidłowe postępowanie w razie konieczności pozbycia się urządzeń elektrycznych lub elektronicznych, utylizacji, powtórnego użycia lub odzysku podzespołów polega na przekazaniu urządzenia do wyspecjalizowanego punktu zbiórki, gdzie będzie przyjęte bezpłatnie. W niektórych krajach produkt można oddać lokalnemu dystrybutorowi podczas zakupu innego urządzenia.

Prawidłowa utylizacja urządzenia umożliwia zachowanie cennych zasobów i uniknięcie negatywnego wpływu na zdrowie i środowisko, które może być zagrożone przez nieodpowiednie postępowanie z odpadami. Szczegółowe informacje o najbliższym punkcie zbiórki można uzyskać u władz lokalnych.

Nieprawidłowa utylizacja odpadów zagrożona jest karami przewidzianymi w odpowiednich przepisach lokalnych.

Użytkownicy biznesowi w krajach Unii Europejskiej

W razie konieczności pozbycia się urządzeń elektrycznych lub elektronicznych, prosimy skontaktować się z najbliższym punktem sprzedaży lub z dostawcą, którzy udzielą dodatkowych informacji.

Pozbywanie się odpadów w krajach poza Unią Europejską

Taki symbol jest ważny tylko w Unii Europejskiej.

W razie potrzeby pozbycia się niniejszego produktu prosimy skontaktować się z lokalnymi władzami lub ze sprzedawcą celem uzyskania informacji o prawidłowym sposobie postępowania.

Informācija lietotājiem par elektrisko un elektronisko iekārtu atkritumiem (privātas mājsaimniecības)



Šis simbols uz produktiem un/vai pievienotajiem dokumentiem nozīmē, ka no atkritumiem paredzētajām elektriskajām un elektroniskajām iekārtām nedrīkst atbrīvoties kopā ar pārējiem mājsaimniecības atkritumiem.

Pienācīgai apstrādei, reģenerācijai un pārstrādei, lūdz, nogādāiet šos produktus tiem paredzētajos savākšanas punktos, kur tie tiks pieņemti bez maksas. Tāpat dažās valstīs jūs iespējams varēsiet nogādāt produktus pie tuvākā mazumtirgotāja, pērkot jaunu līdzvērtīgu produktu.

Pareiza atbrīvošanās no šiem produktiem palīdzēs ietaupīt vērtīgus resursus un izvairīties no potenciāli negatīvas iedarbības uz cilvēka veselību un apkārtni, kas varētu notikt, ja atkritumi netiktu pienācīgi apstrādāti. Lūdz, sazinieties ar vietējām varas iestādēm, lai saņemtu sīkāku informāciju par tuvāko šādiem atkritumiem paredzēto savākšanas punktu.

Var tikt piemēroti sodi par nepareizi šādu atkritumu apstrādi, atbilstoši valsts likumdošanai.

Komerclietotājiem Eiropas Savienībā

Ja vēlaties atbrīvoties no elektrisko un elektronisko iekārtu atkritumiem, lūdz, sazinieties ar tuvāko dīleri vai piegādātāju, lai saņemtu sīkāku informāciju.

Informācija par atbrīvošanos no šādiem atkritumiem valstīs, kas atrodas ārpus Eiropas Savienības

Šis simbols ir derīgs tikai Eiropas Savienībā.

Ja vēlaties atbrīvoties no šī produkta, lūdz, sazinieties ar vietējām varas iestādēm vai tuvāko dīleri un uzziniet pareizo veidu, kā atbrīvoties no šādiem atkritumiem.

DISPOSAL OF UNIT

<p>Informace pro uživatele k likvidaci elektrických a elektronických zařízení (domácnosti)</p>  <p>Tento symbol na produktech anebo v průvodních dokumentech znamená, že použité elektrické a elektronické výrobky nesmí být přidány do běžného komunálního odpadu.</p> <p>Ke správné likvidaci, obnově a recyklaci doručte tyto výrobky na určené sběrné místo, kde budou přijata zdarma. Alternativně v některých zemích můžete vrátit své výrobky místnímu prodejci při koupi ekvivalentního nového produktu.</p> <p>Správnou likvidací tohoto produktu pomůžete zachovat cenné přírodní zdroje a napomáháte prevenci potenciálních negativních dopadů na životní prostředí a lidské zdraví, což by mohly být důsledky nesprávné likvidace odpadů. Další podrobnosti si vyžádejte od místního úřadu nebo nejbližšího sběrného místa.</p> <p>Při nesprávné likvidaci tohoto druhu odpadu mohou být v souladu s národními předpisy uděleny pokuty.</p> <p>Pro podnikové uživatele v zemích Evropské unie</p> <p>Chcete-li likvidovat elektrická a elektronická zařízení, vyžádejte si potřebné informace od svého prodejce nebo dodavatele.</p> <p>Informace k likvidaci v ostatních zemích mimo Evropskou unii</p> <p>Tento symbol je platný jen v Evropské unii.</p> <p>Chcete-li tento výrobek zlikvidovat, vyžádejte si potřebné informace o správném způsobu likvidace od místních úřadů nebo od svého prodejce.</p>	<p>Informacija naudotojams dėl nenaudojamos elektros ir elektroninės įrangos utilizacijos (naudojantiems ją buityje)</p>  <p>Šis simbolis, pažymėtas ant gaminių ir / arba lydymųjų dokumentų, reiškia, kad nenaudojamą elektros ir elektroninių gaminių negalima maišyti su įprastomis buitinėmis atliekomis.</p> <p>Tam, kad gaminiai būtų tinkamai apdoroti, atnaujinti arba perdirbti, prašom nugalbinti juos į paskirtuosius surinkimo punktus, kur juos priims nemokamai. Be to, kai kuriose šalyse jūs galite gražinti turimus gaminius vietiniam mažmeniniam prekybininkui, įsigiję analogišką naują gaminį.</p> <p>Tinkama šio gaminių utilizacija padės sutaupyti vertingų išteklių ir užkirs kelią galimam neigiamam poveikiui žmonių sveikatai bei aplinkai, kuris gali kilti netinkamai tvarkant atliekas. Dėl informacijos apie artimiausią paskirtąjį surinkimo punktą prašom kreiptis į vietos valdžios įstaigas.</p> <p>Pagal jūsų šalies įstatymus, dėl netinkamos šių atliekų utilizacijos jums gali būti skirta bauda.</p> <p>Verslo naudotojams Europos Sąjungoje</p> <p>Jei norite išmesti elektros ir elektroninę įrangą, dėl išsamesnės informacijos prašom kreiptis į jus aptarnaujantį prekybės atstovą arba tiekėją.</p> <p>Informacija dėl utilizacijos šalyse – ne Europos Sąjungos narėse</p> <p>Šis simbolis galioja tik Europos Sąjungoje.</p> <p>Jei norite išmesti šį gaminį, dėl tinkamo utilizacijos būdo teiraukitės vietos valdžios įstaigų arba prekybos atstovo.</p>
<p>Kullanılmayan Elektrikli ve Elektronik Aletlerin Elden Çıkarılmasına İlişkin Bilgi (bireysel kullanıcılar)</p>  <p>Ürünlerde ve/veya üründe birlikte gelen dokümanlarda yer alan bu simge, ömrü sona ermiş elektrikli ve elektronik ürünlerin genel ev çöptüne karıştırılmaması gerektiğini ifade eder.</p> <p>Uygun biçimde toplanmaları, işlenmeleri ve geri dönüşürümleri için lütfen bu tür ürünleri, bunlar için öngörülen ve ücretsiz olarak kabul edilen toplama noktalarına götürün. Ayrıca bazı ülkelerde eski ürününüzü, yeni eşdeğer bir ürün satın aldığınız yerel satıcınıza teslim edebilirsiniz.</p> <p>Ürünün doğru bir şekilde elden çıkarılması, değerli kaynakları korumaya yardımcı olacak ve yanlış biçimde atık gidermenin insan sağlığına ve çevreye verebileceği olası negatif etkileri önleyecektir.</p> <p>Çevrenizdeki en yakın toplama noktasına ilişkin daha ayrıntılı bilgi almak için lütfen yerel yetkililere başvurun.</p> <p>Ürünlerin uygun biçimde elden çıkarılmaması durumunda, ilgili ülkenin yasal düzenlemelerine bağlı olarak cezalar uygulanabilir.</p> <p>Avrupa Birliği dahilindeki kurumsal kullanıcılar için</p> <p>Elektrikli ve elektronik aletleriniz elden çıkarmak istiyorsanız, ayrıntılı bilgi için lütfen satıcınıza veya tedarikçinize başvurun.</p> <p>Avrupa Birliği dışındaki ülkelerde atık gidermeye ilişkin bilgi</p> <p>Bu simge yalnızca Avrupa Birliği sınırları içerisinde geçerlidir.</p> <p>Bu ürünü elden çıkarmak istiyorsanız, lütfen yerel yetkililere veya satıcınıza başvurun ve uygun atık giderme yöntemi konusunda bilgi alın.</p>	<p>Informatie over het weggooien van elektrische en elektronische apparatuur (particulieren)</p>  <p>Dit symbool betekent in Europa dat gebruikte elektrische en elektronische producten niet bij het normale huishoudelijke afval mogen.</p> <p>Lever deze producten in bij de aangewezen inzamelingspunten, waar ze gratis worden geaccepteerd en op de juiste manier worden verwerkt, teruggewonnen en hergebruikt. In Nederland kunt u uw producten bij uw winkelier inleveren bij de aanschaf van een vergelijkbaar nieuw product.</p> <p>Wanneer u dit product op de juiste manier als afval inlevert, spaart u waardevolle hulpbronnen en voorkomt u potentiële negatieve gevolgen voor de volksgezondheid en het milieu, die anders kunnen ontstaan door een onjuiste verwerking van afval. Neem contact op met uw gemeente voor meer informatie over het dichtstbijzijnde inzamelingspunt of raadpleeg www.nvmp.nl, www.ictoffice.nl of www.stibat.nl.</p> <p>Voor zakelijke gebruikers in de Europese Unie</p> <p>Neem voor het weggooien van elektrische en elektronische apparatuur contact op met uw leverancier voor verdere informatie.</p> <p>Informatie over verwijdering van afval in landen buiten de Europese Unie</p> <p>Dit symbool is alleen geldig in de Europese Unie.</p> <p>Neem wanneer u dit product wilt weggooien, contact op met de lokale overheid of uw leverancier en vraag wat de juiste verwijderingsmethode is.</p>
<p>Informações sobre a eliminação de resíduos para utilizadores de equipamentos eléctricos e electrónicos (utilizadores particulares)</p>  <p>Este símbolo nos produtos e/ou documentos anexos significa que os produtos eléctricos e electrónicos usados não devem ser misturados com os resíduos urbanos indiferenciados.</p> <p>Para efectuar um tratamento, recuperação e reciclagem correctos, leve estes produtos para pontos de recolha próprios para o efeito, onde serão aceites gratuitamente. Em alternativa, em alguns países, poderá devolver os produtos ao seu revendedor local, aquando da compra de um produto novo equivalente.</p> <p>A eliminação correcta deste produto ajudará a poupar recursos valiosos e evitar quaisquer potenciais efeitos negativos na saúde humana e no ambiente, que poderiam resultar de um tratamento incorrecto de resíduos. Contacte as autoridades locais para obter mais informações sobre o ponto de recolha mais perto de si.</p> <p>Poderão ser aplicadas multas pela eliminação incorrecta deste resíduo, de acordo com as leis locais.</p> <p>Para utilizadores não particulares na União Europeia</p> <p>Se pretender eliminar equipamento eléctrico e electrónico, contacte o seu revendedor ou fornecedor para obter mais informações.</p> <p>Informações sobre a eliminação noutros países fora da União Europeia</p> <p>Este símbolo apenas é válido na União Europeia.</p> <p>Se pretender eliminar este produto, contacte as suas autoridades locais ou revendedor e peça informações sobre o método de eliminação correcto.</p>	<p>Informacije o odlaganju u otpad za korisnike otpadne električne i elektroničke opreme (privatna domaćinstva)</p>  <p>Ovaj simbol na proizvodima i/ili pripadajućim dokumentima znače da se upotrijebljeni električni i elektronički proizvodi ne smiju miješati s običnim otpadom iz domaćinstava.</p> <p>Za pravilnu obradu, iskorištavanje i recikliranje odnesite ove proizvode u namjenske centre za zbrinjavanje otpada gdje će ih besplatno preuzeti. Osim toga, u nekom državama ćete moći svoje proizvode vratiti lokalnom trgovcu prilikom kupnje ekvivalentnog proizvoda.</p> <p>Pravilnim odlaganjem ovog proizvoda sačuvat ćete vrijedne resurse i spriječiti moguće negativne učinke na ljudsko zdravlje i okoliš koji bi se inače pojavili zbog neodgovarajućeg rukovanja otpadom. Za dodatne pojedinosti o najbližem namjenskom centru za zbrinjavanje otpada obratite se lokalnoj upravi.</p> <p>Mogu se primijeniti kazne za neodgovarajuće odlaganje ovog otpada u skladu s lokalnim zakonima.</p> <p>Za poslovne korisnike u Europskoj uniji</p> <p>Ako želite baciti električnu i elektroničku opremu, obratite se prodavatelju ili dobavljaču za dodatne informacije.</p> <p>Informacije o odlaganju u drugim zemljama izvan Europske unije</p> <p>Ovaj simbol je važeći samo u Europskoj uniji.</p> <p>Ako želite odbaciti ovaj proizvod, molimo kontaktirati lokalne vlasti ili prodavatelja i pitati za ispravnu metodu odlaganja.</p>
<p>Information om kassering för användare av elektrisk & elektronisk utrustning (privata konsumenter)</p>  <p>Om denna symbol finns på produkterna och/eller medföljande dokumentation, betyder det att förbrukade elektriska och elektroniska produkter inte ska blandas med vanlig hushållssopor.</p> <p>För korrekt hantering, inhämtning och återvinning, ska dessa produkter lämnas på återvinningscentraler, där de tas emot utan kostnad. I vissa länder kan du som ett alternativ lämna in dina produkter hos återförsäljaren, när du köper en motsvarande, ny produkt.</p> <p>Om denna produkt avyttras korrekt sparas värdefulla resurser och eventuellt negativa effekter på den mänskliga hälsan och miljön förhindras, vilket kan bli fallet vid felaktig avyttring. Kontakta din lokala myndighet för mer information om var din närmsta återvinningsstation finns.</p> <p>Böter kan tillämpas vid felaktig avyttring av dessa sopor, i enlighet med lagstiftningen i landet.</p> <p>För företagsanvändare inom den Europeiska gemenskapen</p> <p>Om ni vill kassera elektrisk eller elektronisk utrustning, vänligen kontakta er återförsäljare eller leverantör för mer information.</p> <p>Information om kassering i övriga länder utanför den Europeiska gemenskapen</p> <p>Denna symbol gäller bara inom den Europeiska gemenskapen.</p> <p>Om du vill kassera denna produkt ska du kontakta de lokala myndigheterna eller din återförsäljare, och fråga om korrekt avyttringsmetod.</p>	

DISPOSAL OF UNIT

Informacije za uporabnike o odstranitvi odpadne električne in elektronske opreme (zasebna gospodinjstva)



Ta simbol, ki se nahaja na izdelkih in/ali priloženih dokumentih, pomeni, da se rabljeni električni in elektronski izdelki ne smejo mešati z navadnimi gospodinjstskimi odpadki. Za primerno ravnanje, predelavo in reciklažo vas prosimo, da odnesete te izdelke na ustrezne zbirne točke, kjer bodo sprejeti brezplačno. V nekaterih državah boste lahko vrnilli vaše izdelke v vašo lokalno prodajalno, v zameno nakupa novega izdelka. Pravilno odstranjevanje teh izdelkov bo pomagalo obvarovati dragocene vire in preprečilo katerekoli negativne vplive na človeško zdravje in okolje, ki lahko nastanejo pri neprimernem ravnanju z odpadki. Prosimo vas, da za nadaljnje informacije o zakonodajo se zaradi nepravilnega odstranjevanja odpadkov izrečejo primerne kazni.

vaši najbližji zbirni točki kontaktirajte vaše lokalne oblasti. V skladu z nacionalno zakonodajo se zaradi nepravilnega odstranjevanja odpadkov izrečejo primerne kazni.

Za poslovne uporabnike v Evropski uniji

Če se želite znebiti tega izdelka in elektronske opreme vas prosimo, da za nadaljnje informacije kontaktirajte vašega prodajalca ali dobavitelja.

Informacije o odstranitvi v drugih državah, ki so izven Evropske unije

Simbol je veljaven samo v Evropski uniji.

Če se želite znebiti tega izdelka vas prosimo, da kontaktirajte vaše lokalne oblasti ali prodajalca in jih povprašate o ustrezni metodi odstranjevanja.

Informazioni per gli utenti sullo smaltimento di apparecchiature elettriche ed elettroniche obsolete (per i nuclei familiari privati)



Questo simbolo sui prodotti e/o sulla documentazione di accompagnamento significa che i prodotti elettrici ed elettronici usati non devono essere mescolati con i rifiuti domestici generici.

Per un corretto trattamento, recupero e riciclaggio, portare questi prodotti ai punti di raccolta designati, dove verranno accettati gratuitamente. In alternativa, in alcune nazioni potrebbe essere possibile restituire i prodotti al rivenditore locale, al momento dell'acquisto di un nuovo prodotto equivalente.

Uno smaltimento corretto di questo prodotto contribuirà a far risparmiare preziose risorse ed evitare potenziali effetti negativi sulla salute umana e sull'ambiente, che potrebbero derivare, altrimenti, da uno smaltimento inappropriato. Per ulteriori dettagli, contattare la propria autorità locale o il punto di raccolta designato più vicino.

In caso di smaltimento errato di questo materiale di scarto, potrebbero venire applicate delle penali, in base alle leggi nazionali.

Per gli utenti aziendali nell'Unione Europea

Qualora si desidera smaltire apparecchiature elettriche ed elettroniche, contattare il rivenditore o il fornitore per ulteriori informazioni.

Informazioni sullo smaltimento in nazioni al di fuori dell'Unione Europea

Questo simbolo è valido solo nell'Unione Europea.

Qualora si desidera smaltire questo prodotto, contattare le autorità locali o il rivenditore e chiedere informazioni sul metodo corretto di smaltimento.

Informazzjoni dwar ir-Rimi għall-Utenti ta' Skart ta' Tagħmir Elettriku u Elektroniku (unitajiet domestiċi privati)



Dan is-simbolu fuq il-prodotti u/jew id-dokumenti ta' appoġġ ifisser li prodotti elettrici u elettronici ma għandhomx jiġihallu ma' skart domestiku ġenerali.

Għal trattament, irkupru jew riċiklaġġ xieraq, jekk jogħġbok hu dawn il-prodotti f'punti ta' għbir apposta, fejn jiġu accettati fuq bażi mingħajr ħlas. Inkella, f'xi pajjiżi tista' tirritorna l-prodotti tiegħek għand bejjiegh bl-inmut lokali max-xiri ta' prodott ġdid ekwivalenti.

Billi tarmi dan il-prodott b'mod korrett tkun qed tgħin sabieq tikkonserva riżorsi prezzjużi u ttiprevieni kwalunkwe effett negattiv fuq is-saħħa tal-bniedem u l-ambjent li inkella jista' jirriżulta minn trattament ta' skart mhux xieraq. Jekk jogħġbok ikkuntattja lill-awtorità lokali tiegħek għal aktar dettalji dwar l-eqreb punt tal-għbir deżinjat tiegħek.

F'każ ta' rimi mhux korrett ta' dan l-iskart jistgħu japplikaw penali, f'konformità mal-leġiżlazzjoni nazzjonali.

Għal utenti tan-negozju fl-Unjoni Ewropea

Jekk tixtieq tarmi tagħmir elettriku u elektroniku, jekk jogħġbok ikkuntattja lin-negozjant jew lill-fornitur tiegħek għal aktar informazzjoni.

Informazzjoni dwar ir-Rimi f'Pajjiżi oħra barra mill-Unjoni Ewropea

Dan is-simbolu huwa validu biss fl-Unjoni Ewropea.

Jekk tixtieq tarmi dan il-prodott, jekk jogħġbok ikkuntattja lill-awtoritajiet lokali jew lin-negozjant tiegħek u staqsihom għall-metodu ta' rimi korrett.

Tietoja sähkö- ja elektroniikkalaitteiden hävittämisestä (kotitaloudet)



Tämä symboli tuotteissa ja/tai niiden käyttöohjeissa osoittaa, että käytettyjä sähkö- ja elektroniikkalaitteita ei saa hävittää tavallisen kotitalousjätteen mukana.

Jotta laitteet käsitellään asianmukaisesti, toimita ne kierrätyspisteisiin, jotka vastaanottavat tällaisia laitteita ilmaiseksi. Joissakin maissa kuluttajat voivat myös palauttaa käytetyt laitteet paikalliselle jälleenmyyjälle, jos he ostavat tilalle uuden vastaavanlaisen tuotteen.

Tämän tuotteen asianmukainen hävittäminen säästää luonnonvaroja ja estää mahdollisesti muutoin syntyviä ympäristö- ja terveysongelmia. Lähistöllä sijaitsevista kierrätyspisteistä saa lisätietoja paikallisilta viranomaisilta.

Jätelaissa ja rikoslaisissa on säädetty rangaistus roskaamisesta ja lainvastaisesta hävittämisestä.

Yrityskäyttäjät Euroopan unionissa

Jos haluat hävittää sähkö- ja elektroniikkalaitteita, kysy lisätietoja jälleenmyyjältä tai tavarantoimittajalta.

Tietoja jätteiden käsittelystä Euroopan unionin ulkopuolella

Tämä symboli on käytössä vain Euroopan unionissa.

Jos haluat hävittää tämän tuotteen, tiedustele oikeaa hävitystapaa paikallisilta viranomaisilta tai jälleenmyyjältä.

Informasjon for brukerne om kassering av elektrisk og elektronisk utstyr (private husholdninger)



Når et produkt og/eller medfølgende dokumenter er merket med dette symbolet, betyr det at det elektriske eller elektroniske utstyret ikke bør kasseres sammen med vanlig husholdningsavfall.

For at det kasserte utstyret skal bli behandlet, gjenvunnet og resirkulert på riktig måte, må du bringe det til nærmeste innsamlingspunkt eller gjenvinningsstasjon. I enkelte land kan du alternativt returnere produktene dine til den lokale forhandleren, eventuelt mot kjøp av et tilsvarende nytt produkt.

Hvis du kasserer dette produktet på riktig måte, bidrar til du til å bevare verdifulle ressurser og til å motvirke de negative virkningene på miljøet og den menneskelige helse som kan forårsakes av feilaktig avfallsbehandling. Ta kontakt med de lokale myndigheter hvis du ønsker ytterligere informasjon om ditt nærmeste innsamlingspunkt.

Feilaktig kassering av dette utstyret kan kanskje bøtlegges, avhengig av nasjonale lover og regler.

For bedriftskunder i den Europeiske Union

Hvis du ønsker å kassere elektrisk og elektronisk utstyr, må du kontakte forhandleren eller leverandøren din for å få mer informasjon.

Informasjon om kassering i land utenfor den Europeiske Union

Dette symbolet er kun gyldig i den Europeiske Union.

Hvis du ønsker å kassere dette produktet, må du ta kontakt med forhandleren eller de lokale myndigheter og spørre dem om hvordan det skal kasseres på riktig måte.

Kasutajate elektri- ja elektroonikaseadmete kõrvaldamist puudutav teave (eramajapidamised)



See toodetel ja/või kaasas olevates dokumentides märgitud sümbol tähendab, et kasutatud elektri- ja elektroonikaseadmeid ei tohi kõrvaldada koos olmejäätmetega.

Korrektselt töötlemiseks, taaskasutuseks ja ringlussevõtuks viige need tooted kogumispunkti, kus need tasuta vastu võetakse. Samuti on mõnes riigis võimalik tooted kohalikule edasimüüjale tagastada juhul, kui ostatekse uus võrdväärne toode.

Selle toote korrektne kõrvaldamine aitab meil väärtuslikke ressursse säästa ning vältida inimeste tervisele ja keskkonnale võimalikke negatiivseid mõjusid, mis võivad tekkida sobimatu jäätmekäituse tagajärjel. Pöörduge oma kohaliku omavalitsuse poole, et saada lisateavet teile lähima kogumispunkti kohta.

Selle jäätme sobimatu kõrvaldamine eest võidakse kohaldada siseriiklikele õigusnormidele vastavaid karistusi.

Euroopa Liidu ärikasutajatele

Kui soovite elektri- ja elektroonikaseadmeid kõrvaldada, pöörduge lisa teabe saamiseks oma edasimüüja või tarnija poole.

Kõrvaldamist puudutav teave muudes riikides väljaspool Euroopa Liitu

See sümbol kehtib ainult Euroopa Liidus.

Kui soovite seda toodet kõrvaldada, pöörduge oma kohaliku omavalitsuse või edasimüüja poole ning küsige neilt korrektsete kõrvaldamismeetmete kohta.

Информације за корисника о одлагању Отпадне електричне и електронске опреме (приватна домаћинства)



Овај симбол на производима и/или пратећој документацији значи да искоришћене електричне и електронске производе не треба мешати са обичним кућним смећем.

Да би ови производи били правилно третирани, поново искоришћени и рециклирани, однесите их на предвиђена сабирна места где ће бити бесплатно прихваћени. Друга могућност је да у неким земљама можете да вратите производе локалном продавцу када купите еквивалентни нови производ.

Одлагање овог производа на правилан начин штеди драгоцене ресурсе и спречава потенцијалне негативне ефекте на здравље људи и животну средину, који би иначе настали због неправилног руковања отпадом. Обратите се локалним властима за више детаља о најближем предвиђеном сабирном месту.

Неправилно одлагање овог отпада може бити кажњиво по националним законима.

За пословне кориснике у Европској унији

Ако желите да одложите електричну и електронску опрему, обратите се свом продавцу или добављачу за више информација.

Информације о одлагању у другим земљама изван Европске уније

Овај симбол се односи само на Европску унију.

Ако желите да одложите овај производ у отпад, обратите се локалним властима или продавцу и распитајте се о правилном начину одлагања.

TEMPERATURE RECORDER (OPTION)

The chamber temperature can be recorded and checked by installing an optional temperature recorder (MTR-G04 or MTR-0621LH).

✧ Contact our sales representative or agent for the purchase of temperature recorder.

Main specifications of temperature recorder

	MTR-G04	MTR-0621LH
Application	Refrigerator & Freezer	Refrigerator
Recording range	-10 °C to +40 °C	-6 °C to +20 °C
Feed speed of recorder chart	1-day/1 turn, 7-day/1 turn, 32-day/1 turn	31-day/batch
Recorder chart	Circular type	Strip type
Power source	Supplied from the refrigerator	Dry cell

✧ For the installation of temperature recorder MTR-G04, the recorder mounting bracket MPR-S7 is necessary.

✧ For the installation of temperature recorder MTR-0621LH, the recorder mounting bracket MPR-S30 is necessary.

BATTERY MOUNTING BOX (OPTION)

It is recommended to install an optional battery mounting box (MPR-48B1) to prevent the rise of chamber temperature in the case of power failure. At the power failure, the alarm activates to prompt an action for preventing the storage items.

✧ Contact our sales representative or agent for the purchase of battery mounting box.

INTERFACE BOARD (OPTION)

Three types of interface boards (MTR-480, MTR-L03, and MTR-420MA) are available as optional components. MTR-480 has a connector for RS232C and a connector for RS485. MTR-L03 has a connector for LAN. MTR-420MA has output terminals for analog connections.

✧ Only one of these three interface boards can be used at a time.

✧ Contact our sales representative or agent for the purchase of the interface boards.

SPECIFICATIONS

Product name	Pharmaceutical Refrigerator	
	MPR-1412	MPR-1412R
External dimensions	W1440 mm x D830 mm + (90) mm x H1955 mm	
Internal dimensions	W1320 mm x D710 mm x H1500 mm	
Effective capacity	1364 L	1359 L
Exterior	Painted steel	
Interior	Painted steel	
Door	Painted steel, Provided with glass window Glass: 2-layer pair glass with heat ray reflection film	
Insulation	Rigid polyurethane foamed-in place	
Shelves	Hard steel wire on polyethylene coating x 8, Allowable load; 50 kg/shelf Inner dimensions; W530 mm x D604 mm	-----
Drawers	-----	Painted steel x 10 Allowable load; 40 kg/drawer Inner dimensions; W550 mm x D530 mm x H100 mm
Access port	Inner diameter; 30 mm, Left side, Right side, Top	
Cooling method	Forced cool air circulation	
Compressor	Hermetic type, Output; 270 W x 1	
Evaporator	Fin and tube type	
Condenser	Wire and tube type	
Refrigerant	R-1234yf	
Defrosting	Cycle defrost + forced defrost	
Defrost heater	306 W / 335 W / 361 W (MPR-1412/1412R-PE) 321 W (MPR-1412/1412R-PA)	
Temperature controller	ON/OFF control	
Temperature display	Digital display (in 1 °C, 0.1 °C increments)	
Alarms	High-temp. alarm, Low-temp. alarm, 0 °C alarm, Air circulation alarm, Door alarm	
Remote alarm contact	Allowable contact capacity: DC 30 V, 2 A *	
Weight	257 kg	296 kg
Accessories	2 keys, 2 nylon clips, 2 binders	
Optional components	Temperature recorder (MTR-G04, MTR-0621LH) Recorder mounting bracket (MPR-S7, MPR-S30) Interface board (MTR-480, MTR-L03)* Analog Interface board (MTR-420MA)* Battery mounting box (MPR-48B1) Light shielding plate (MPR-72BP)**	

◇ Design or specifications will be subject to change without notice.

◇ The dimension in () shows the projected dimension.

◇ Refer to the updated catalog when ordering an optional component.

* It is recommended to use cables with a maximum length of 30 meters.

** This is one plate package. To shield both windows, two packages are necessary.

PERFORMANCE

Product name	Pharmaceutical Refrigerator	
	MPR-1412	
Model number	MPR-1412-PE	MPR-1412-PA
Temperature control range	2 °C to 14 °C (ambient temperature; -5 °C to 0 °C, no load) 2 °C to 23 °C (ambient temperature; 0 °C to 35 °C, no load)	
Noise level	48 dB (A scale)	
Maximum pressure	1550 kPa	
Rated voltage	AC 220 V / 230 V / 240 V	AC 115 V
Rated frequency	50 Hz	60 Hz
Power consumption	460 W / 470 W / 490 W	490 W
Usable ambient condition	Temperature; -5 °C to 35 °C, Humidity; equal or less than 80% RH	

Product name	Pharmaceutical Refrigerator	
	MPR-1412R	
Model number	MPR-1412R-PE	MPR-1412R-PA
Temperature control range	2 °C to 14 °C (ambient temperature; -5 °C to 0 °C, no load) 2 °C to 23 °C (ambient temperature; 0 °C to 35 °C, no load)	
Noise level	48 dB (A scale)	
Maximum pressure	1550 kPa	
Rated voltage	AC 220 V / 230 V / 240 V	AC 115 V
Rated frequency	50 Hz	60 Hz
Power consumption	460 W / 470 W / 490 W	490 W
Usable ambient condition	Temperature; -5 °C to 35 °C, Humidity; equal or less than 80% RH	

- ✧ The above data is measured based on our internal basis.
- ✧ Design or specifications will be subject to change without notice.
- ✧ The unit with CE mark complies with EU directives.

CAUTION

Please fill in this form before servicing.
Hand over this form to the service engineer to keep for his and your safety.

Safety check sheet

1. Unit contents:

- Risk of infection: Yes No
Risk of toxicity: Yes No
Risk from radioactive sources: Yes No

(List all potentially hazardous materials that have been stored in this unit.)

Notes:

2. Contamination of the unit:

Unit interior:

- No contamination: Yes No
Decontaminated: Yes No
Contaminated: Yes No

Others:

3. Instructions for safe repair/maintenance/disposal of the unit

- a) The unit is safe to work on Yes No
b) There is some danger (see below) Yes No

Procedure to be adhered to in order to reduce safety risk indicated in b) below.

Date:

Signature:

Address, Division:

Telephone:

Product name: Pharmaceutical Refrigerator	Model: MPR-	Serial number:	Date of Installation:
---	----------------	----------------	-----------------------

Please decontaminate the unit yourself before calling the service engineer.

DOMINIQUE DUTSCHER SAS

DOMINIQUE DUTSCHER SAS

DOMINIQUE DUTSCHER SAS

PHC Corporation

1-1-1 Sakada, Oizumi-machi, Ora-gun, Gunma 370-0596, Japan

© PHC Corporation 2024



LDCL085200-3

Printed in Japan
LDCL085200-3
J0324-30825