

The logo for revvity, featuring the word "revvity" in a white, lowercase, sans-serif font on a black background. The background of the entire page is a vibrant, abstract image of overlapping, translucent spheres in shades of yellow, orange, and green, resembling a molecular or cellular structure.

revvity

**USER MANUAL**

# OM500 Ultrasonic Homogenizer

Version: B

Date: September 2024

Document Number: 03-2021-500

Data herein has been verified and validated. It is believed adequate for the intended use of the instrument. If the instrument or procedures are used for purposes over and above the capabilities specified herein, confirmation of the validity and suitability should be obtained; otherwise Revvity does not guarantee results and assumes no obligation or liability. This publication is not a license to operate under, or a recommendation to infringe upon, any process patents.

This product is warranted to be free from defects in material and workmanship for a period of ONE YEAR from the date of delivery. Ultrasonic probes are guaranteed against defects for a period of ONE YEAR from date of shipment. A defective probe will be replaced once without charge, if failure occurs within the warranty period. Wear resulting from cavitation erosion is a normal consequence of ultrasonic processing and is not covered by this warranty.

Revvity will repair or replace and return free of charge any part which is returned to its factory within said period, transportation prepaid by user, and which is found upon inspection to have been defective in materials or workmanship. This warranty does not include normal wear from use; it does not apply to any instrument or parts which have been altered by anyone other than an employee of Revvity nor to any instrument which has been damaged through accident, negligence, failure to follow operating instructions, the use of electric currents or circuits other than those specified on the plate affixed to the instrument, misuse, or abuse. Revvity reserves the right to change, alter, modify, or improve any of its instruments without any obligation whatever to make corresponding changes to any instrument previously sold or shipped.

THE FORGOING OBLIGATION IS IN LIEU OF ALL OBLIGATIONS AND LIABILITIES INCLUDING NEGLIGENCE AND ALL WARRANTIES OF MERCHANTABILITY OR OTHERWISE, EXPRESSED OR IMPLIED IN FACT OR BY LAW, AND STATE OUR ENTIRE AND EXCLUSIVE LIABILITY AND BUYERS EXCLUSIVE REMEDY FOR ANY CLAIM OF DAMAGES IN CONNECTION WITH THE SALE OR FURNISHING OF GOODS OR PARTS, THEIR DESIGN, SUITABILITY FOR USE, INSTALLATION, OR OPERATION. REVVITY WILL IN NO EVENT BE LIABLE FOR ANY SPECIAL OR CONSEQUENTIAL DAMAGES WHATSOEVER, AND THEIR LIABILITY UNDER NO CIRCUMSTANCES WILL EXCEED THE CONTRACT PRICE FOR THE GOODS FOR WHICH LIABILITY IS CLAIMED.

This product has been engineered for safety; however, basic safety precautions and common sense must always be demonstrated when using any electrical product.

High voltage is present in the generator (power supply), converter and high frequency cable. There are no user-serviceable parts inside any of these devices.

- **DO NOT** attempt to remove the generator cover or converter case.
- **DO NOT** touch any open cable connections on the unit while the power is turned ON.
- **DO NOT** operate generator with converter disconnected from high voltage cable. High voltage is present in the cable and may pose a shock hazard.
- **DO NOT** attempt to disconnect the converter high voltage cable while the unit is running.
- **DO NOT** allow the tip of a vibrating horn or probe to touch the counter top or any other hard surface. It could damage the probe, overload the generator, or damage the surface.
- **DO NOT** operate unit with a damaged cable. Doing so may cause serious injury.
- **DO NOT** turn off Main power switch while running a probe. Stop sonication by lowering intensity setting knob to 0 or release thumb switch.
- **NEVER** immerse the converter in liquids of any kind, or let condensed moisture or liquid drip into the converter.
- **NEVER** grasp an activated horn or touch the tip of a vibrating probe. It can cause severe burns and tissue damage.
- **NEVER** allow a probe to vibrate in air.
- **NEVER** hold or clamp the converter by the front driver or by the horn itself. This can cause permanent damage to the system. Support the converter by only clamping around the converter housing (upper portion).

- Avoid touching the bottom or sides of a sample vessel with an activated probe. It may crack or shatter the glass or melt the plastic. Use glassware that is free from cracks or chips.
- Turn OFF the power switch, unplug the generator and disconnect the power cord from the back of the generator before attempting to replace the fuses.
- Inspect high frequency cable for cracks in the protective outer jacket.
- The generator must be properly grounded with a 3-prong plug. Test electrical outlet for proper grounding prior to plugging in unit.
- Install the OM500 Ultrasonic Homogenizer in an area free from excessive dust, dirt, explosive or corrosive fumes and protected from extremes in temperature and humidity. Do not place the Generator within a Fume Hood.
- Hearing protection is highly recommended. It is recommended that a sound abating enclosure or ear protection be used when operating the OM500 Ultrasonic Homogenizer
- In case of AC power loss, wait 3 minutes minimum before reapplying power.

### **Copyright**

This manual is published by Revvity 935 Cobb Place Blvd, Kennesaw, GA 30144 USA. Copyright Revvity, Inc. All rights reserved, including but not limited to those rights to reproduce this publication or parts thereof. Reproduction of this publication or parts thereof, or the products it describes, by any means or in any form is expressly prohibited without the written permission of Revvity.

### **Trademarks**

Revvity is a registered trademark of Revvity. All other trademarks are the property of their respective owners.

### **Proper Equipment Operation**

To reduce the risk of electric shock, do not remove the cover. No user serviceable parts are inside. Refer to qualified service personnel if help is required.

Use this product only in the manner described in this manual. If the equipment is used in a manner not specified by the manufacturer, the protection provided by the equipment may be impaired.

### **Cleaning**

Follow internal laboratory process for cleaning and decontamination using 70% ethanol followed by a disinfecting wipe, then a final rinse with ethanol.

### **Preventative Maintenance**

Normal use: 12 month interval.

### **Operating Environment**

39°F to 104°F / 5°C to 40°C, Humidity: 10% to 95% RH. Internal use only

### **Electrical Supply**

90-230V, 50/60 Hz, 4A Max

### **FCC**

This device complies with part 15 of the FCC (United States Federal Communications Commission) Rules. Operation is subject to the following two conditions:

- This device may not cause harmful interference, and
- This device must accept any interference received, including interference that may cause undesired operation.

### **CE/UKCA**











This device complies with all CE and UKCA rules and requirements.

Changes or modifications to this equipment not expressly approved by the party responsible for compliance could void the user's authority to operate the equipment.

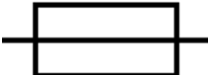
## Table of Contents

Table of Symbols.....	5
Specifications.....	6
Principles of Operation.....	7
Relationship of Amplitude and Wattage .....	7
System Overview .....	9
Functions Key Controls and Connectors.....	10
Convertor Clamping.....	11
Preparation for Use .....	12
Inspection .....	12
Electrical Requirements .....	12
Installing the OM500 Ultrasonic Homogenizer.....	12
Operating Instructions .....	13
Setup.....	13
Operation - Amplitude .....	14
Operation - Microtip Amplitude Setting Limits.....	14
Operation - Timer .....	15
Operation - Pulser.....	15
Operation - Review .....	16
Maintenance.....	17
Microtip/Probe Maintenance.....	17
Attaching and Detaching Probes .....	17
System Cleaning Instructions.....	19
Troubleshooting.....	19
Overload Condition .....	19
Frequently Asked Questions .....	20
Probe Size versus Sample Volume.....	20
How to Prevent Foaming (Small Sample Issue).....	20
Tip depth.....	21
Power versus Intensity.....	21
Viscosity Limitations.....	21
Keeping Samples Cool.....	21
Addendum .....	22
Convertor Cooling .....	22
Cooling Air Regulation and Adjustment .....	23
Accessories .....	24
Appendix.....	25
Transport and Storage.....	25
Equipment Disposal.....	25

**Table of Symbols**

Symbol	Description	Symbol	Description
	Caution. Refer to the User documentation (ISO 7000-0434B)		On (power). (IEC 60417-5007)
	Hazardous voltage; risk of electric shock. (IEC 60417-6042)		Off (power). (IEC 60417-5008)
	Fuse. (IEC 60417-5016)		Consult Instructions for Use. (ISO 7000-1641)
	Alternating current. (IEC 60417-5032)		CE Compliance Mark
	UKCA Certification Mark		WEEE symbol (EN50419:2005)
	RoHS Certification Mark		

## Specifications

Part Number	29-060-500-120 and 29-060-500-220
<b>Power Supply</b>	
Input Voltage	100 to 132 VAC @ 50/60 Hz and 198 to 264 VAC @ 50/60 Hz
Rated Current	10 Amps Max and 6.4 Amps Max
Fuse Rating	12 Amps Slow Blow and 6.3 Amps Slow Blow
Output Voltage	1000 VRMS
Output Frequency	20 KHz
Rated Power	500 Watts
Weight	16 lbs. (6.8 kg)
Dimensions	W: 8" (20.0 cm) x D: 15.25" ( cm) x H: 8.5 (21.6 cm)
<b>Convertor</b>	
Weight	2.0 lbs. (0.9 kg)
Dimensions	L: 7.25" (18.3 cm) x Dia. 2.5" (6.4 cm)
Materials	Aluminum Alloy
<b>Environmental</b>	
Pollution Degree	2
Overvoltage Category	II
Temperature	39°F to 104°F / 5°C to 40°C
Relative Humidity	10 to 95% (Non Condensing)
Altitude	6,651 ft. (2000 m)
Warranty	1 Year
Standards Approval	CE and UKCA Approved
Other	For Indoor Use Only

The power cord supplied with the OM500 Ultrasonic Homogenizer must be used.

If the 220V plug is not configured to match the wall receptacle, a properly grounded universal AC socket adapter must be added.

**IMPORTANT: Universal adapters do not convert voltage or frequency. Manufacturer is not responsible for damage caused by the use of an improper power cord or adapter. Transformers are not recommended.**

## Principles of Operation

The OM500 ultrasonic power supply transforms AC line power to a 20 KHz signal that drives a piezoelectric converter/transducer. This electrical signal is converted by the transducer to a mechanical vibration due to the characteristics of the internal piezoelectric crystals.

The vibration is amplified and transmitted down the length of the horn/probe where the tip longitudinally expands and contracts. The distance the tip travels is dependent on the amplitude selected by the user through the keypad. As you increase the amplitude setting the sonication intensity will increase within your sample.

In liquid, the rapid vibration of the tip causes cavitation, the formation and violent collapse of microscopic bubbles. The collapse of thousands of cavitation bubbles releases tremendous energy in the cavitation field. The erosion and shock effect of the collapse of the cavitation bubble is the primary mechanism of fluid processing.

The probe tip diameter dictates the amount of sample that can be effectively processed. Smaller tip diameters probes deliver high intensity sonication, but the energy is focused within a small, concentrated area. Larger tip diameters can process larger volumes but offer lower intensity.

The choices of a power supply and horns/probes are matched to the volume, viscosity, and other parameters of the application. Horns are available for both direct and indirect sonication.

## Relationship of Amplitude and Wattage

Sonication power is measured in watts. Amplitude is a measurement of the excursion of the tip of the probe (a probe is also known as a horn).

Some ultrasonic homogenizers have a wattage display. During operation, the wattage displayed is the energy required to drive the radiating face of a probe, at that amplitude setting against a specific load, at that moment. For example, the unit experiences a higher load when processing viscous samples than when compared to aqueous samples.

The speed/cruise control on an automobile can, to a certain extent, be compared to an ultrasonic homogenizer. The speed/cruise control is designed to ensure that the vehicle maintains a constant rate of travel. As the terrain elevations change, so do the power requirements. The cruise control senses these requirements and automatically adjusts the amount of power delivered by the engine to compensate for these ever-changing conditions. The greater the terrain rate of incline and resistance to the vehicle's movement, the greater the amount of power delivered by the engine to overcome that resistance and maintain a constant speed.

The OM500 ultrasonic homogenizer was designed to deliver constant amplitude to your liquid sample, regardless of these changes in load (much like the vehicle's cruise control described above). As a liquid is processed, the load on the probe will vary due to changes in the liquid sample (i.e., viscosity, concentration, temperature, etc.). As the resistance to the movement of the probe increases (increased load on the probe), additional power will be delivered by the power supply to ensure that the excursion at the probe tip remains constant. The displayed wattage readings will vary as the load changes; however, the amplitude will remain the same.

The resistance to the movement of the probe determines how much power will be delivered to maintain amplitude. For example, a 1/2" probe at 100% amplitude will require approximately 5 watts to operate in air. The amplitude of this probe is approximately 120um. Insert the probe in water and the wattage reading will increase to approximately 90 watts. The wattage required to operate the probe will increase as the load increases, but the amplitude remains the same.

The amplitude control allows the ultrasonic vibrations at the probe tip to be set to any desired level. Although the degree of cavitation/ultrasonic energy required to process the sample can readily be determined by visual observation, the amount of power required cannot be predetermined. A sensing network continuously monitors the output requirements, and automatically adjusts the power to maintain the amplitude at the preselected level. The greater the resistance to the movement of the probe due to higher viscosity, deeper immersion of the probe into the sample, larger probe diameter or higher pressure, the greater the amount of power that will be delivered to the probe. Setting the amplitude control to its maximum will not cause the maximum power rating of the unit to be delivered to the sample. The maximum power (500 watts) that the sonicator is capable of delivering will only be delivered when the resistance to the movement of the probe is high enough to draw the maximum wattage.

It is the intensity of cavitation that measures the effectiveness of sonication, not the total power applied to the system. Intensity is related to the amplitude of the radiating face of the tip or horn. It is amplitude that must be provided, maintained, and monitored. The unit provides controlled amplitude under varying load conditions to give reproducible results.

DOMINIQUE DUTSCHER SAS

# System Overview

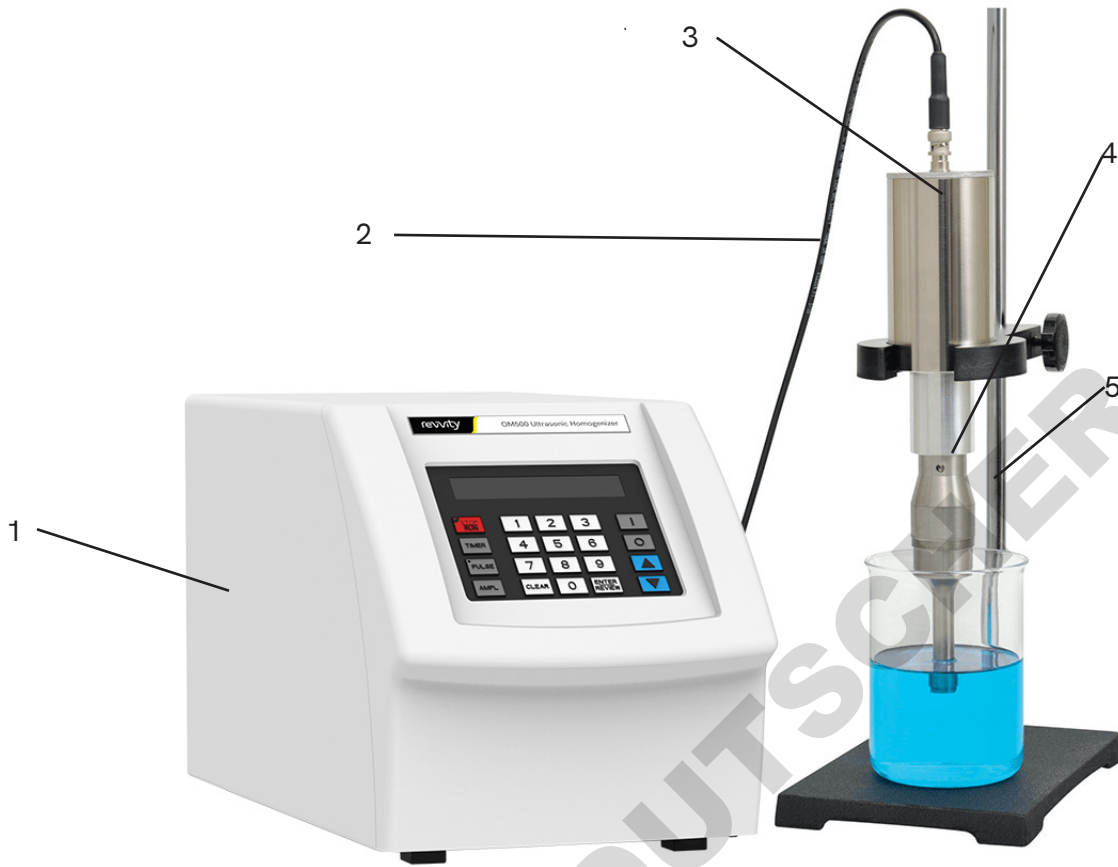

- 1. Power Supply
- 2. Convertor Cable
- 3. Convertor
- 4. Probe
- 5. Lab Stand with Clamp
- 6. Convertor Cable Connector
- 7. Cooling Fan
- 8. Nine Pin Connector
- 9. Footswitch Jack
- 10. Fuses
- 11. Power Cord Connector

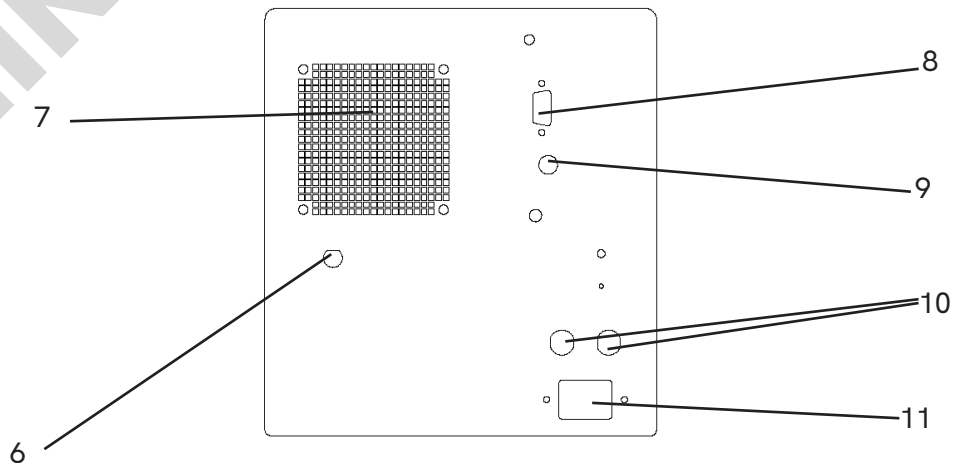

## Functions Key Controls and Connectors

Front Panel	
LCD display	Displays prompts and the following control parameters: <ul style="list-style-type: none"> <li>▪ Amplitude selected</li> <li>▪ Output power delivered to the probe in watts</li> <li>▪ Selected duration of processing</li> <li>▪ Actual processing time</li> <li>▪ Elapsed time</li> <li>▪ Set and read temperature</li> <li>▪ Pulse on/off duration</li> <li>▪ Accumulated amount of energy in Joules delivered to the probe</li> </ul>
0-9 key	Input digits.
CLEAR key	Clears the preceding entry
ENTER REVIEW key	Enters data into the program, and selects various parameters, for display on the LCD display
TIMER key	Used with the numeric keys to set the duration of ultrasonic application - from 1second to 9 hours, 59 minutes, 59 seconds.
PULSER key	Used with the numeric keys to set the pulse mode. The ON cycle and OFF cycle can be set independently from 1 second to 59 seconds. Red indicator lights when pulser is in the OFF portion of the cycle.
START/STOP key	Starts or stops the ultrasonics. In the STOP mode the red indicator goes off.
I key	Switches the main power on.
O key	Switches the main power off
AMPL	Controls the amplitude of vibration at the probe tip.
key	Used with the AMPL key when the unit is on stand-by to set the amplitude of vibration at the probe tip. Also used to increase or decrease the amplitude in small increments while the unit is running. To accomplish this task, depress the ENTER/REVIEW key twice to display AMPLITUDE CONTROL, then depress the $\square$ or $\square$ key as required.

Back Panel	
9 pin D-sub connector (IO Port)	Connects to external actuation device, and enable power and frequency monitoring.
Footswitch Connector	Connects to the footswitch cable.
Converter Cable Connector (Output)	Connects to the converter.
Power Supply Connector	Connects to the electrical line cord and encases the fuse(s).

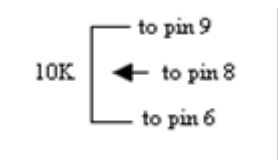
9-Pin Sub Connector	
1	Not connected
2	Not connected
3	Not connected
4	Enables connection to a frequency counter.
5	Enables connection to external power monitor (5 mv = 1 watt)
6	Ground
7	Energizes the ultrasonics when connected to ground.
8 and 9	 <p>Enables the intensity to be remotely adjusted using an external 10k potentiometer.</p>

**NOTE:** To vary the intensity remotely using a variable DC power supply (0-5V) instead of a 10 K potentiometer, connect positive to pin 8 and negative to pin 6.

### Convertor Clamping

Improper clamping can damage the system and void the warranty. Using a sound enclosure (part #060-22) or stand (part #060-20) will ensure a proper fit.



Proper Clamping



Improper Clamping

## Preparation for Use

### Inspection

Prior to installing the OM500 Ultrasonic Homogenizer, perform a visual inspection to detect any evidence of damage, which might have occurred during shipment. Before disposing of any packaging material, check it carefully for small items.

The OM500 Ultrasonic Homogenizer was carefully packed and thoroughly inspected before leaving our factory. The carrier, upon acceptance of the shipment, assumed responsibility for its safe delivery. Claims for loss or damage sustained in transit must be submitted to the carrier.

If damage has occurred, contact your carrier within 48 hours of the delivery date. **DO NOT OPERATE DAMAGED EQUIPMENT.** Retain all packing materials for future shipment.

### Electrical Requirements

The OM500 Ultrasonic Homogenizer requires a fused, single phase 3-terminal grounding type electrical outlet capable of supplying 50/60 Hz at 100 volts, 115 volts, 220 volts, or 240 volts, depending on the voltage option selected. For power requirements, check the label on the back of the unit. Should it become necessary to convert the unit for different voltage operation, proceed as follows:

- Ensure that the power cord is not connected to the electrical outlet.
- Open the fuse holder cover using a small screwdriver.
- Pull out the red fuse holder from its housing.
- To convert from 100/115V to 220/240V replace the two 3 Amp slow blow fuses, with 1.6 Amp fuses.
- To convert from 220/240V to 100/115V reverse the procedure above.
- Rotate the fuse holder 180° from its original position, and reinsert it into its housing. For 100/115V operation the voltage displayed should be 115. For 220/240V operation the voltage display should be 220.
- Change the electrical power cord as required.
- Clearly note on the label or back of the unit that the voltage has changed.

**WARNING: For your personal safety, do not, under any circumstances, defeat the grounding feature of the power cord by removing the grounding prong.**

### Installing the OM500 Ultrasonic Homogenizer

The OM500 Ultrasonic Homogenizer should be installed in an area that is free from excessive dust, dirt, explosive and corrosive fumes, and extremes of temperature and humidity. If processing flammable liquids use an approved fume hood and do not place the power supply in the fume hood.

When positioning the unit, be sure to leave adequate space behind the unit so that all connections can be easily disconnected.

## Operating Instructions

- Do not operate the power supply unless it is connected to the converter.
- Never allow liquid to spill into the converter.
- Do not allow a Microtip to vibrate in air.
- Do not allow the vibrating Microtip to contact anything but the sample.
- Never place a washer between the converter, probe or horn.
- Never apply grease to the mating surfaces or threads of any component.
- Should it become necessary to remove a probe, use the wrenches supplied. Never attempt to remove the probe by twisting the converter housing or holding it in a vice, as this may damage the electrical connections within the housing.
- Overheating will damage the converter. If continuous operation for more than 15 minutes is required, see addendum for converter cooling instructions.
- Replaceable tip probes (1/2" - 1" diameter) are made for use with water based samples only. If the liquid being processed is an organic solvent or any liquid with a lower surface tension than water - always use a Solid tip probe. Solid tips can be used with any type of liquid.



**NOTE: The temperature of the converter front area (where the probe attaches) should never exceed 60 °C (140 °F). If this temperature is reached, shut the system off and allow to cool.**

**Do not allow the system to operate for more than 1 minute without a rest or pulse to prevent overheating.**

### Setup

1. Connect the power cord into the receptacle on the rear of the OM500 Ultrasonic Homogenizer.
2. Make sure the unit is switched off. Plug the electrical line cord into the electrical outlet.
3. If the optional foot switch is used, insert the plug into the jack located on the rear panel.
4. For best results it is critical to use the appropriate size and type of accessory to process your sample. If you are not sure that you have the proper horn for your sample volume, please refer to the product brochure or call for assistance.
5. Horns/Probes must be properly tightened. Depending on the accessories purchased, often the horn and the flat tip are attached to the converter at the factory. Check the tightness of the horn and flat tip by using the wrench set. Please refer to images in the Maintenance section of this manual. A loose horn or tip may cause damage to the power supply circuitry or parts of the converter and horn. A loose horn may also show a fluctuation in wattage readings. Always use the wrenches supplied with the unit.
6. If you will be using a Microtip or extender, remove the flat tip on the end of the replaceable tip probe, then attach the Microtip or extender in its place.
7. Microtips must be used in pulse mode to prevent overheating - which could potentially crack the tip. See page 16 for Microtip Limits and contact us with questions.
8. Horns and probe tips wear after normal usage. Using a severely worn probe tip can damage internal power supply components.
9. If using a laboratory stand, mount the converter /probe assembly using a clamp. Be sure to secure the clamp to the upper section of the converter housing only. Never secure the clamp to any other portion of the converter/probe assembly. If you are using an acoustic enclosure mount the converter properly in the converter collar.
10. Connect the converter cable to the power supply and then to the top of the converter. Push the connectors in and turn the chrome rings clockwise ¼ turn to secure the connectors.
11. If the application requires long processing times we recommended chilling the sample and pulsing sonication. If processing for over 15 minutes the converter may get warm and require cooling with dry, compressed air. See converter cooling instructions in the Addendum.

## Operation - Amplitude

Press the ON key. The screen will display the power rating of the OM500 Ultrasonic Homogenizer and the following control parameters.



**AMPLITUDE:** Desired amplitude must be set in order for the OM500 Ultrasonic Homogenizer to be operational. The other control parameters – Time and Pulse, do not have to be set for continuous operation. AMPL displays the percentage of amplitude that was previously selected. To set the amplitude at 40%, when the ultrasonics is off, press the AMPL key and the numeric keys for a 40% reading on the screen, and then press the ENTER/REVIEW key. (Pressing the AMPL key and the  $\square$  or  $\square$  key for a reading of 40% and then pressing the ENTER/REVIEW key, will also achieve the same result.)

**NOTE:** The minimum amplitude setting is 20%.

The screen will display:



## Operation - Microtip Amplitude Setting Limits

Tip Diameter	Maximum Amplitude
1/16" (1.6 mm)	40%
1/8" (3.2 mm)	40%
1/4" (6.4 mm)	50%

1. Immerse the probe approximately halfway into the sample. If the probe is immersed to an insufficient depth, air will be injected into the sample, causing the sample to foam. Also ensure that the probe tip is not touching the wall of the sample vessel.
2. The OM500 Ultrasonic Homogenizer is now ready for continuous operation. To energize the ultrasonics, press the START key or the footswitch. To de-energize the ultrasonics, press the STOP key or release the footswitch. If the Time or Pulse functions must be used, refer to the appropriate paragraphs below.

**NOTE:** The START key and footswitch are mutually exclusive. If the process is initiated by the START key, the footswitch becomes inoperative. If the process is initiated by the footswitch, the STOP key becomes inoperative.

3. To increase or decrease the amplitude in small increments when the ultrasonics is on, depress the AMPL to display Amplitude Setting on the screen, then depress the  $\square$  or  $\square$  key, as required. Since the amplitude required is application dependent and subject to the volume and composition of the sample, it is recommended that the amplitude be selected through experimentation, by increasing or decreasing the level of intensity as needed to properly process the sample to achieve desired results.
4. Be sure to use the fittings provided, for the top of the Converter, for air cooling if necessary. Circulate clean dry compressed air through the Converter to cool the Converter during use. See manual addendum for more information.

## Operation - Timer

TIMER - In the pulsed mode the processing time will be different from the elapsed time because the processing time function monitors and controls only the ON portion of the duty cycle. For example, for 30 minute processing time, the elapsed time will be 1 hour if the ON and OFF pulse cycle is set for 10 seconds on and 10 seconds off.

1. To set the processing time, press the TIMER key. The screen will display:

Time Setting  
Hrs: - Min: -- Sec: --

2. Using the numeric keys, set the processing time as required, for example:

Time Setting  
Hrs: 0 Min: 30 Sec: 00

3. Press the ENTER/REVIEW key. The screen will display:

Time 0:30:00  
Pulse -- --                      Ampl 40 %

## Operation - Pulser

PULSER: Ultrasonics generates heat. Pulsing ultrasonics on and off helps to prevent heat build-up in temperature sensitive samples. In addition, pulsing may enhance processing by allowing the material to settle back under the probe after each burst. The ON and OFF pulse duration can be set independently from 01 second to 59 seconds. During the OFF portion of the cycle, the red indicator on the PULSE key will illuminate. If the OFF portion of the cycle exceeds three seconds, a cautionary message - Sonics in OFF Cycle - will warn the operator against touching the ultrasonic probe.

1. To set the pulser, press PULSE key. The screen will display:

Pulse on \_\_ sec  
Pulse off \_\_ sec

2. Using the numeric keys, set the ON portion of the cycle and press the ENTER/REVIEW key. The screen will display:

Pulse on 10 sec  
Pulse off \_\_ sec

3. Using the numeric keys set the OFF portion of the cycle. The screen will display:

Pulse on 10 sec  
Pulse off 10 sec

4. Press the ENTER/REVIEW key. The screen will display:

Time 0:30:00  
Pulse 10 10                      Ampl 40 %

## Operation - Review

REVIEW: The REVIEW function provides a “window” on the process by displaying various operating parameters without process interruption. Pressing the ENTER/REVIEW key repeatedly during processing will consecutively display the following information.

Selected amplitude: e.g. Amplitude 40%

Selected processing time and elapsed processing time: e.g. Set 0:10:00 Time 0:05:00

Selected pulsing cycle and actual pulsing cycle: e.g. Pulse 05 05 / 05 00

Amount of power in watts, and accumulated amount of energy in JOULES delivered to the probe: e.g. 20 watts  
0000000 Joules

**NOTE: The amount of energy displayed will be only for one cycle. Initiating a new cycle will reset the display to zero.)**

Elapsed time since processing was initiated: e.g. Elapsed time 0:05:00

DOMINIQUE DUTSCHER SAS

## Maintenance

It is recommended to periodically inspect the unit, both visually and physically, to insure optimum and safe performance. This inspection should be scheduled as a routine maintenance procedure, done with the unit power OFF and with the unit unplugged from the AC power source.

Long exposure to acids or caustics results in corrosion of metal parts or components. Check the power supply, converter, and cables periodically for any signs of rust or discoloration. If discoloration is found, move the OM500 Ultrasonic Homogenizer away from the source of the contaminant.

Examine the condition of the high voltage cable that attaches the converter to the power supply. Inspect the wire insulation for damage, such as wear, burning from hot plate contact or breakage from extended use or rough handling. In general use, the cable assembly should not be used to carry the converter or pull it toward the user. Make certain the cable always has slack and is never tensioned. If necessary, move the power supply or converter assembly closer to one another to accomplish this.

**WARNING: Do not use a cable with broken end connections, exposed wires or frayed insulation. High voltage is present in the cable and will pose a shock hazard. Do not touch the converter assembly until the power switch is off and the unit is unplugged.**

### Microtip/Probe Maintenance

Ultrasonic Homogenizers create high intensity vibration which puts stress on the converter and horn assembly. The sides and end of the probe must never be allowed to come in contact with anything but the solution while in operation. When using a Microtip, the stress resulting at the point of contact with the vessel could cause the Microtip to fracture.

Proper care of the probe is essential for dependable operation. The intense cavitation will, after usage for period of time, cause the tip to erode, and the power output to decrease. The smoother and shinier the tip, the more power will be transmitted into the sample. The vibrations may also cause the probe tip to loosen over time or the threaded connection to accumulate debris.

**NOTE: A loose probe will usually generate a loud piercing or squealing sound.**

For that reason, it is recommended that a preventative maintenance schedule be adopted to examine the unit at regular intervals. The schedule should depend on frequency of use. Weekly maintenance schedules are recommended for units used frequently or monthly for those used infrequently. The tip must be examined for excessive wear and to ensure that the threaded connection is clean and attached properly to the converter. Use a cotton swab and alcohol (i.e. ethanol, isopropyl, etc.) to clean the threaded mating surfaces.

When excessive wear (corrosion/pitting of the probe tip) is detected the probe should be replaced with a new one.

**WARNING: Probes must be properly tightened with the appropriate Wrench Set.**

### Attaching and Detaching Probes

1. Disconnect probe from converter. Use the wrench set provided with the system.
2. Clean threaded stud. Use alcohol and a cotton swab to remove any debris on the threading of the connecting stud. Allow the alcohol to dry completely.
3. Clean threading in converter. Use alcohol and a cotton swab to remove any debris on the threading. Do not allow liquid to drip into converter. Allow the alcohol to dry completely.
4. Re-attach probe to converter. Screw the probe back onto the converter and tighten with the wrench set provided.

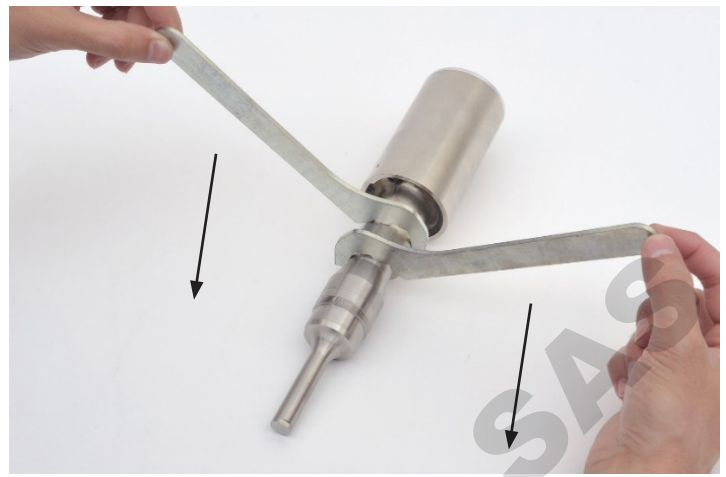
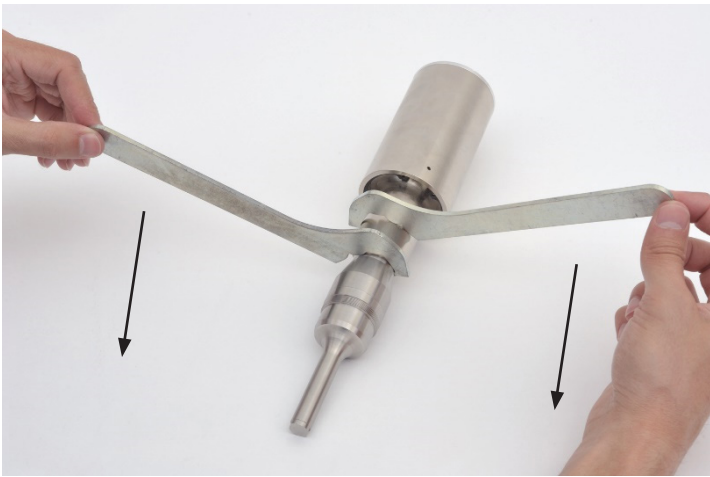

5. The tips on replaceable tip probes can be removed for cleaning and/or replacement. When replacing horns or horn tips, always clean the threaded mating surfaces of the converter and horn. Use alcohol and a cotton swab to remove any debris on the threading of the tip or probe. If the replaceable tip loosens during sonication, be sure to remove the tip for cleaning and inspect the threading on the tip and probe. Call the manufacturer for assistance if the threading is chipped or damaged in anyway.

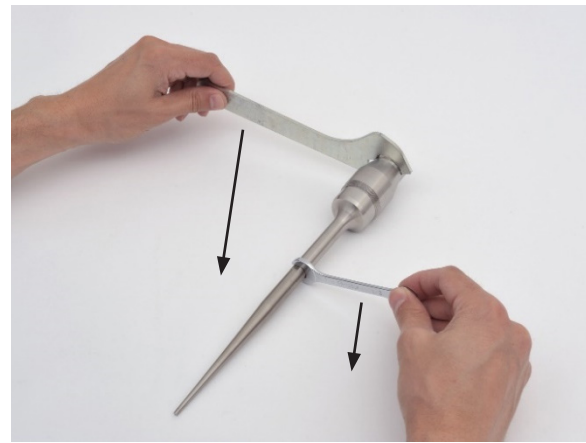
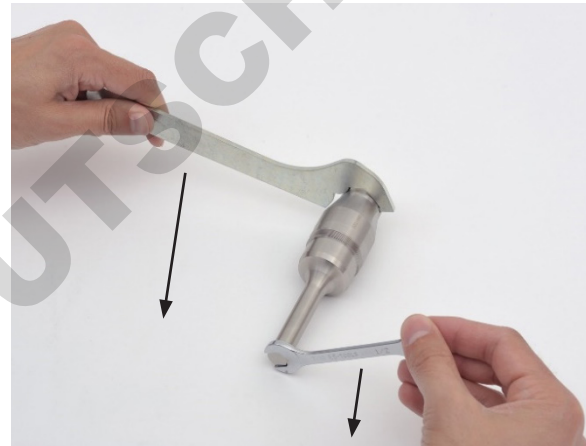
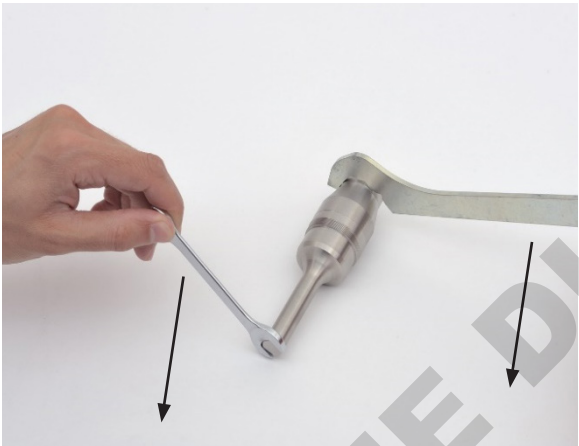

**NOTE:** When tightening a Microtip the tip must not be in contact with the work surface. Always have the tip extending off of the table or work surface to minimize stress to the tip.

## System Cleaning Instructions

The power supply and converter may be cleaned using an acid-free cleaning solution (i.e. glass cleaner).

Probes should be cleaned using isopropyl alcohol. Probes are made from titanium and can be autoclaved (the converter is an electrical part and cannot be sterilized in this manner). Before each procedure place the probe tip in water or alcohol and turn the power on for a few seconds to remove residue. The tip also can be sterilized using alcohol with the power on.

## Troubleshooting

Your OM500 Ultrasonic Homogenizer was designed to provide you with years of safe and dependable service. Nevertheless, because of component failure or improper usage, the possibility does exist that it might not perform as it should, shut down or stop working all together. The most probable causes for malfunction are listed below and should be investigated.

- The system is overheating.
- A connector or cable is damaged.
- The unit was plugged into an electrical outlet that provides a different voltage from that required. See Electrical Requirements.
- The horn, probe, booster or microtip is not tightened properly with the wrenches provided.
- The converter and/or microtip may have been dropped.
- A microtip being operated is damaged or worn past its useful life.
- A fuse(s) has failed.

## Overload Condition

If the OM500 Ultrasonic Homogenizer stops working, and an OVERLOAD indication is displayed on the screen, check for possible causes as outlined in the above paragraph, then press the OFF key to switch the unit off, and the ON key to switch the unit back on.

Most faults can be solved by cleaning all mating and threaded surfaces using isopropyl alcohol and properly re-assembling tightly together using the appropriate wrenches.

**NOTE: If the display freezes, switch Off main power, wait 5 seconds and switch back On.**

**NOTE: If you touch Start and sonication does not occur, switch Off main power, wait 5 seconds and switch back On.**

**If the problem persists after inspecting all of these, please contact Customer Service for additional assistance or to replace a worn probe or damaged part.**

## Frequently Asked Questions

### Probe Size versus Sample Volume

Selecting the proper size probe is a critical factor when sonicating a sample. The sample volume to be processed must correlate with the tip diameter. Each probe has a recommended sample volume range. This range may overlap with other probes.

For example, the 1/2" probe can process approximately 20 to 250 mL.

Depending on the type of sample you may be able to process a little less than 20 mL or more than 250 mL. Depending on the vessel size and shape, the 1/2" probe may have difficulty fitting inside a 20 mL volume and a 1/4" microtip may be a better option. Many factors must be considered when selecting the appropriate probe for your application.

Small volumes require a small tip to fit inside the sample tube. Small tips (or Microtips) are recommended for processing samples inside small, thin vessels and never samples larger than 50 mL. Microtips are high intensity and made for short processing times. Using a microtip for long time periods will generate a considerable amount of heat. Microtips should be used in pulse mode to reduce heat buildup.

Larger volumes require a larger probe for effective processing. For example, a 1" probe will process 1 liter much faster than a 3/4" probe. Using the proper size probe will not only reduce the processing time but increase the lifespan of the probe. The addition of a stir bar can greatly aid processing of large samples. A probe should not be used to process a volume larger than indicated on the chart.

While there is no absolute sample volume range for any probe/horn, below is a general guideline to follow. Using a sample volume outside each tip diameter's range is normally not recommended. Processing volumes are application specific.

Tip Diameter	Processing Volume Range
1/16" (1.6 mm)	200 µL to 5 mL
1/8" (3.2 mm)	500 µL to 15 mL
1/4" (6.4 mm)	10 mL to 50 mL
1/2" (12.7 mm)	20 mL to 250 mL
3/4" (19.1 mm)	50 mL to 500 mL
1" (25.4 mm)	100 mL to 1 L

### Vessel Shape and Size

A narrow vessel is preferable to a wide vessel. The ultrasonic energy is generated from the tip and is directed downward. As a sample is processed the liquid is pushed down and away in all directions. If the vessel is too wide, it will not mix effectively and some sample will remain untreated at the periphery. The probe should never touch the sides or bottom of the vessel.

### How to Prevent Foaming (Small Sample Issue)

Foaming is a problem that often occurs with samples volumes below 1ml. The cause of foaming is generally 3 issues: amplitude is too high for a small volume, tip is too large for the volume, or the tip is not inserted to a proper depth.

## Tip depth

The depth of the probe within the liquid is an important issue. If the probe is too close to the surface of the liquid, it can create foam. If the probe is too deep, it may sonicate against the bottom of the vessel and not effectively processing the sample. The sample must flow freely below the tip in order to be mixed effectively.

Without effective mixing you cannot ensure the entire sample volume will pass below the tip and become processed. The probe should be submerged approximately halfway into the liquid but there are exceptions. Before processing actual samples, it is recommended to test the probe in a vessel filled with water to observe the ultrasonic energy and the flow pattern of the liquid. During this test you can adjust the probe's depth until you see adequate mixing and movement of the water.

## Power versus Intensity

Power is the measure of the electrical energy that is being delivered to the converter. It is measured in watts and displayed on the sonicator's screen. At the converter, the electrical energy is transformed into mechanical energy. It does this by exciting the piezoelectric crystals causing them to move in the longitudinal direction within the convertor. This change from electrical into mechanical energy causes a motion that travels through the horn/probe causing the tip to move up and down.

The distance of one movement up and down is called its amplitude. The amplitude is adjustable. Each probe has a maximum amplitude value. For example, with a 1/8" diameter probe at setting 100%, the probe will achieve an amplitude of approximately 180µm. At setting 50% the amplitude is approximately 90µm.

**NOTE: This is approximate and not perfectly linear. We measure the amplitude of each probe at 100% and these values are published in the brochure.**

Amplitude and intensity have a direct relationship. If you operate at a low amplitude setting, you will deliver low intensity sonication. If you operate at a high amplitude setting, you will have high intensity sonication. In order to be able to reproduce results, the amplitude setting, temperature, viscosity and volume of the sample are all parameters that need to remain consistent. The amplitude, not the power, is most critical when trying to reproduce sonication results.

Power has a variable relationship with amplitude/intensity. For example, sonicating water requires less wattage when compared to a viscous sample (such as oil). While sonicating both samples at the same amplitude setting the power/wattage will differ because the viscous sample will require more watts in order to drive the horn. The viscous sample puts a heavier load on the probe so they system must work harder to vibrate up and down at the same amplitude setting. The oil may draw double the watts when operated at the same amplitude as the water sample.

Small fluctuation in the wattage during sonication is normal. Major swings in wattage (+/- 20 watts) may indicate a problem with the sample, setup or the sonicator itself.

## Viscosity Limitations

Viscous solutions and highly concentrated liquids can be difficult to sonicate. If the liquid is so thick that it cannot be easily poured out of a vessel it is likely too viscous to be sonicated.

## Keeping Samples Cool

Ultrasonic processing causes the liquid temperature to elevate especially with small volumes. Pulsed sonication is always recommended. The addition of an ice bath or recirculating chiller to cool the sample vessel is strongly suggested.





## Addendum

### Converter Cooling

Continuous sonication will cause both the probe and sample temperature to increase. The heat will transfer up to the converter. If the converter overheats the internal crystals can crack and the entire converter will require replacement. Converter damage due to overheating is not covered under warranty.

Cooling the sample by submerging the beaker or tube in ice will help to cool the probe and converter. Chillers are also commonly used. If you have an application that requires greater than 15 minutes of continuous processing (at high amplitude) there is potential for the probe/converter assembly to increase in temperature.

The general rule is that if the converter is warm to the touch it should be cooled. In addition to cooling the sample you must cool the converter with compressed air. Each converter has 2 threaded ports for air cooling. 10psi of dry, clean (5 micron filtered) air is required. One port is attached to the air source and the other port remains open as a vent.

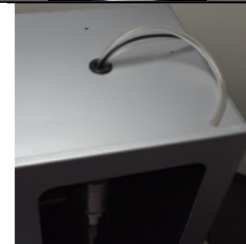
Step	Description	Reference
1	Feel for holes under the label on the end of the converter. Use a razor to expose both holes.	
2	Attach fittings. Black fittings shown come attached to the converter in a small clear bag.  Replacement fittings are available at no charge upon request.	
3	Attach a clean, dry, regulated compressed air source to one of the 1/4" Air Cooling hose bars.  Note: The compressed air should be dry, oil free and filtered with a 5 micron filter.	
4	A 2nd hose must be attached to the 2nd 1/4" fitting.  This hose will exhaust the air from the converter outside of the sound enclosure	
5	The exhaust hose needs to exit the top of the enclosure and extend out approximately 8 inches	

## Cooling Air Regulation and Adjustment

Adjust the regulated compressed air until the gauge indicates  $10 \pm 1$  PSIG (approximately 4 CFM). The compressed air will flow into the converter and out through the outlet barb. Verify the compressed air is flowing out from the exhaust tube upon each use.

Example of the air cooling hoses set up properly with the enclosure.



DOMINIQUE DUISCHER SAS

## Accessories

Part Number	Description
060-062K	1/16" (1.6 mm) Microtip Diameter Probe
060-125K	1/8" (3.2 mm) Microtip Diameter Probe
060-250K	1/4" (6.4 mm) Microtip Diameter Probe
060-500	1/2" (12.7 mm) Diameter Replaceable Tip Probe
060-750	3/4" (19.1 mm) Diameter Replaceable Tip Probe
060-1000	1" (25.4 mm) Diameter Replaceable Tip Probe
060-500R	1/2" (12.7 mm) Diameter Replacement Probe Tip
060-750R	3/4" (19.1 mm) Diameter Replacement Probe Tip
060-1000R	1" (25.4 mm) Diameter Replacement Probe Tip
060-20	Support Stand with Converter Holder for OM500
060-21	Heavy Duty Stand for OM Sonicators
060-22	Sound Enclosure with Converter Holder for OM500 Sonicator
060-23	Replacement Converter for OM500
060-24	6 ft Replacement Converter Cable for OM500 Sonicator
060-26	Replacement Wrench Set

## Appendix

### Transport and Storage

Permissible environmental conditions for transport and storage of the equipment:

- Temperature 35°F to 120°F / 2°C to 49°C
- Relative Humidity 10 % to 95 % (Non Condensing)
- Altitude 40,000 ft. (12,192 m)

### Equipment Disposal

This equipment is marked with the crossed-out wheeled bin symbol, to indicate that this equipment may not be disposed of as unsorted municipal waste.

It's your responsibility to correctly dispose of your equipment at life-cycle end, by handing it over to an authorized facility for separate collection and recycling of waste equipment. It's also your responsibility to decontaminate your equipment in case of biological, chemical or radiological contamination, and so protect the persons involved in the disposal and recycling of the equipment from health hazards.

For more information about where you can dispose of your waste equipment, please contact your local dealer, from whom you purchased the equipment.

By doing so, you will help to preserve natural and environmental resources and you will ensure that your equipment is recycled in a manner that protects human health.



**DOMINIQUE DUTSCHER SAS**

This page left blank intentionally.

**DOMINIQUE DUTSCHER SAS**

This page left blank intentionally.



The information provided in this document is for reference purposes only and may not be all-inclusive. Revvity, Inc., its subsidiaries, and/or affiliates (collectively, "Revvity") do not assume liability for the accuracy or completeness of the information contained herein. Users should exercise caution when handling materials as they may present unknown hazards. Revvity shall not be liable for any damages or losses resulting from handling or contact with the product, as Revvity cannot control actual methods, volumes, or conditions of use. Users are responsible for ensuring the product's suitability for their specific application. REVVITY EXPRESSLY DISCLAIMS ALL WARRANTIES, INCLUDING WARRANTIES OF MERCHANTABILITY OR FITNESS FOR A PARTICULAR PURPOSE, REGARDLESS OF WHETHER ORAL OR WRITTEN, EXPRESS OR IMPLIED, ALLEGEDLY ARISING FROM ANY USAGE OF ANY TRADE OR ANY COURSE OF DEALING IN CONNECTION WITH THE USE OF INFORMATION CONTAINED HEREIN OR THE PRODUCT ITSELF.

[www.revvity.com](http://www.revvity.com)

revvity

For research use only. Not for use in therapeutic or diagnostic procedures

Revvity, Inc.  
940 Winter Street  
Waltham, MA 02451  
USA  
[www.revvity.com](http://www.revvity.com)

For a complete listing of our global offices, visit [www.revvity.com](http://www.revvity.com)  
Copyright ©2024, Revvity, Inc. All rights reserved.