

Nom Produit <i>Product Name</i>		PE neutre 60 µm <i>Clear PE 60 µm</i>
---	---	---

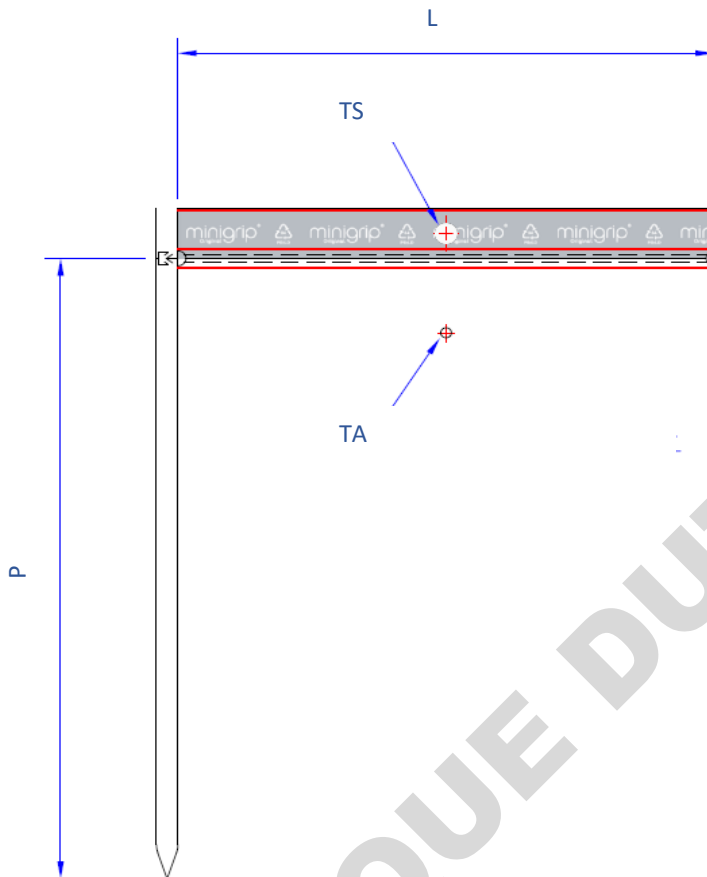

Sachets DE* / DE* bags

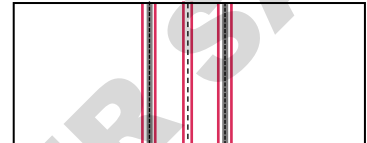

Sachets SE* / SE* bags



Rouleau / Bundle



Description / Description	
Largeur (mm) / Width	L (+2/+5 mm)
Profondeur (mm) Depth	P (+/- 4mm)
Voile (mm) / Lip	20 (+/- 5 mm)
Epaisseur (µm) / Thickness	60 µm (+/- 7% en moyenne/ +/- 7% in average)
Matière / Raw Materials	LDPE - 04
Caractéristique / Characteristic	Fermeture intégrée / integrated closure
Liseré / Colour line	Oui: 3 liserés rouges / yes: 3 red lines
Autres / Additional	

* DE = Double Extrusion / Double Extrusion ; * SE = Simple Extrusion / Single Extrusion





Article Article	L X P	Ø Trou TS / TA Ø Hole TS / TA	Conditionnement - Pièces/carton Packing – Pieces/box	Caisse (L x l x H) / poids brut * Carton size (L x W x H) / grossweight *	Contenance Maxi (ml) * Max capacity (ml) *
ITM020201	40 x 60	Ø TS 6 mm	1000 (10 rouleaux de 100 sachets DE) 1000 (10 bundles of 100 bags DE)	190 x 190 x 80 mm / 0,6 kg	15
ITM020252	50 x 70	Ø TS 6 mm	1000 (10 rouleaux de 100 sachets DE) 1000 (10 bundles of 100 bags DE)	190 x 190 x 80 mm / 0,8 kg	40
ITM020206	50 x 180	Ø TS 8 mm	1000 (20 rouleaux de 50 sachets DE) 1000 (20 bundles of 50 bags DE)	190 x 190 x 125 mm / 1,8 kg	120
ITM020208	60 x 80	Ø TS 8 mm	1000 (10 rouleaux de 100 sachets DE) 1000 (10 bundles of 100 bags DE)	190 x 190 x 125 mm / 1,3 kg	50
ITM020253	60 x 120	Ø TS 8 mm	1000 (10 rouleaux de 100 sachets DE) 1000 (10 bundles of 100 bags DE)	190 x 190 x 125 mm / 1,6 kg	100
ITM020254	60 x 220	Ø TS 8 mm	1000 (20 rouleaux de 50 sachets DE) 1000 (20 bundles of 50 bags DE)	190 x 190 x 190 mm / 2 kg	200
ITM020255	70 x 100	Ø TS 8 mm	1000 (10 rouleaux de 100 sachets DE) 1000 (10 bundles of 100 bags DE)	190 x 190 x 125 mm / 1,6 kg	100
ITM020209	70 x 170	Ø TS 8 mm	1000 (20 rouleaux de 50 sachets DE) 1000 (20 bundles of 50 bags DE)	190 x 190 x 190 mm / 2,2 kg	210
ITM020602	75 x 90	-	1000 (10 rouleaux de 100 sachets DE) 1000 (10 bundles of 100 bags DE)	190 x 190 x 125 mm / 1,6 kg	90
ITM020212	80 x 120	Ø TS 8 mm	1000 (10 rouleaux de 100 sachets DE) 1000 (10 bundles of 100 bags DE)	190 x 190 x 125 mm / 2 kg	170
ITM020211	85 x 180	Ø TS 8 mm Ø TA 4 mm	1000 (20 rouleaux de 50 sachets DE) 1000 (20 bundles of 50 bags DE)	190 x 190 x 190 mm / 2,8 kg	330
ITM020215	90 x 90	Ø TS 8 mm	1000 (10 rouleaux de 100 sachets DE) 1000 (10 bundles of 100 bags DE)	190 x 190 x 125 mm / 1,7 kg	130
ITM020216	90 x 100	-	1000 (10 rouleaux de 100 sachets DE) 1000 (10 bundles of 100 bags DE)	190 x 190 x 125 mm / 2 kg	150
ITM020217	100 x 100	Ø TS 8 mm	1000 (10 rouleaux de 100 sachets DE) 1000 (10 bundles of 100 bags DE)	190 x 190 x 125 mm / 2,1 kg	160
ITM020604	100 x 125	-	1000 (10 rouleaux de 100 sachets DE) 1000 (10 bundles of 100 bags DE)	190 x 190 x 190 mm / 2,5 kg	220
ITM020218	100 x 150	Ø TS 8 mm	1000 (10 rouleaux de 100 sachets DE) 1000 (10 bundles of 100 bags DE)	190 x 190 x 190 mm / 2,8 kg	320
ITM020219	100 x 200	Ø TS 8 mm	1000 (20 rouleaux de 50 sachets DE) 1000 (20 bundles of 50 bags DE)	290 x 256 x 140 mm / 3,4 kg	460

Article Article	L X P	Ø Trou TS / TA Ø Hole TS / TA	Conditionnement - Pièces/carton Packing – Pieces/box	Caisse (L x l x H) / poids brut * Carton size (L x W x H) / grossweight *	Contenance Maxi (ml) * Max capacity (ml) *
ITM020265	100 x 220	Ø TS 8 mm	1000 (20 rouleaux de 50 sachets DE) 1000 (20 bundles of 50 bags DE)	290 x 256 x 140 mm / 3,4 kg	550
ITM020256	100 x 250	Ø TS 8 mm	1000 (20 rouleaux de 50 sachets DE) 1000 (20 bundles of 50 bags DE)	290 x 256 x 140 mm / 4 kg	640
ITM020221	110 x 170	Ø TS 8 mm	1000 (20 rouleaux de 50 sachets DE) 1000 (20 bundles of 50 bags DE)	290 x 256 x 140 mm / 3,3 kg	420
ITM020222	110 x 300	Ø TS 8 mm	1000 (20 rouleaux de 50 sachets DE) 1000 (20 bundles of 50 bags DE)	290 x 256 x 140 mm / 5,3 kg	980
ITM020223	115 x 150	-	1000 (10 rouleaux de 100 sachets DE) 1000 (10 bundles of 100 bags DE)	190 x 190 x 190 mm / 3,2 kg	400
ITM020267	120 x 170	Ø TS 8 mm	1000 (20 rouleaux de 50 sachets DE) 1000 (20 bundles of 50 bags DE)	290 x 256 x 140 mm / 3,6 kg	470
ITM020224	120 x 180	Ø TS 8 mm	1000 (20 rouleaux de 50 sachets DE) 1000 (20 bundles of 50 bags DE)	290 x 256 x 140 mm / 3,8 kg	500
ITM020266	120 x 280	Ø TS 8 mm	1000 (20 rouleaux de 50 sachets DE) 1000 (20 bundles of 50 bags DE)	290 x 256 x 140 mm / 5,2 kg	1000
ITM020257	130 x 200	Ø TS 8 mm	1000 (20 rouleaux de 50 sachets DE) 1000 (20 bundles of 50 bags DE)	290 x 256 x 140 mm / 4,4 kg	600
ITM020228	130 x 320	Ø TS 8 mm	1000 (20 rouleaux de 50 sachets DE) 1000 (20 bundles of 50 bags DE)	290 x 256 x 200 mm / 6,5 kg	1350
ITM020230	140 x 170	Ø TS 8 mm	1000 (20 rouleaux de 50 sachets DE) 1000 (20 bundles of 50 bags DE)	290 x 256 x 140 mm / 4,5 kg	600
ITM020258	140 x 220	Ø TS 8 mm	1000 (20 rouleaux de 50 sachets DE) 1000 (20 bundles of 50 bags DE)	290 x 256 x 200 mm / 5,1 kg	970
ITM020232	150 x 180	Ø TS 8 mm	1000 (20 rouleaux de 50 sachets DE) 1000 (20 bundles of 50 bags DE)	290 x 256 x 200 mm / 4,8 kg	800
ITM020233	150 x 200	Ø TS 8 mm	1000 (20 rouleaux de 50 sachets DE) 1000 (20 bundles of 50 bags DE)	290 x 256 x 200 mm / 4,8 kg	920
ITM020268	150 x 220	Ø TS 8 mm	1000 (20 rouleaux de 50 sachets DE) 1000 (20 bundles of 50 bags DE)	290 x 256 x 200 mm / 5,3 kg	1050
ITM020259	150 x 320	Ø TS 8 mm	1000 (20 rouleaux de 50 sachets DE) 1000 (20 bundles of 50 bags DE)	290 x 256 x 200 mm / 7,2 kg	1800
ITM020237	160 x 220	Ø TS 8 mm	1000 (20 rouleaux de 50 sachets DE) 1000 (20 bundles of 50 bags DE)	290 x 256 x 200 mm / 5,4 kg	1200
ITM020238	160 x 280	Ø TS 8 mm	1000 (20 rouleaux de 50 sachets DE) 1000 (20 bundles of 50 bags DE)	290 x 256 x 200 mm / 6,9 kg	1650
ITM020239	180 x 250	Ø TS 8 mm	1000 (20 rouleaux de 50 sachets DE) 1000 (20 bundles of 50 bags DE)	290 x 256 x 200 mm / 6,5 kg	1600
ITM020260	180 x 280	Ø TS 8 mm	1000 (20 rouleaux de 50 sachets DE) 1000 (20 bundles of 50 bags DE)	390 x 390 x 200 mm / 7,4 kg	2000
ITM020240	180 x 350	Ø TS 8 mm	1000 (20 rouleaux de 50 sachets DE) 1000 (20 bundles of 50 bags DE)	390 x 390 x 200 mm / 9,1 kg	2700

Article Article	L X P	Ø Trou TS / TA Ø Hole TS / TA	Conditionnement - Pièces/carton Packing – Pieces/box	Caisse (L x l x H) / poids brut * Carton size (L x W x H) / grossweight *	Contenance Maxi (ml) * Max capacity (ml) *
ITM020241	200 x 200	Ø TS 8 mm	1000 (20 rouleaux de 50 sachets DE) 1000 (20 bundles of 50 bags DE)	390 x 390 x 200 mm / 7,1 kg	1400
ITM020261	200 x 250	Ø TS 8 mm Ø TA 4 mm	1000 (20 rouleaux de 50 sachets DE) 1000 (20 bundles of 50 bags DE)	390 x 390 x 200 mm / 8,4 kg	2100
ITM020501	200 x 300	Ø TS 8 mm	1000 (20 rouleaux de 50 sachets DE) 1000 (20 bundles of 50 bags DE)	390 x 390 x 200 mm / 9,4 kg	2700
ITM020262	200 x 300	Ø TS 8 mm Ø TA 4 mm	1000 (20 rouleaux de 50 sachets DE) 1000 (20 bundles of 50 bags DE)	390 x 390 x 200 mm / 9,4 kg	2700
ITM020243	220 x 280	Ø TS 8 mm Ø TA 4 mm	1000 (20 rouleaux de 50 sachets DE) 1000 (20 bundles of 50 bags DE)	390 x 390 x 200 mm / 8,6 kg	2750
ITM020244	220 x 320	Ø TS 8 mm	1000 (20 rouleaux de 50 sachets DE) 1000 (20 bundles of 50 bags DE)	390 x 390 x 200 mm / 10,2 kg	3400
ITM020263	230 x 300	Ø TS 8 mm Ø TA 4 mm	1000 (20 rouleaux de 50 sachets DE) 1000 (20 bundles of 50 bags DE)	390 x 390 x 200 mm / 10,5 kg	3500
ITM020246	230 x 320	Ø TS 8 mm Ø TA 4 mm	1000 (20 rouleaux de 50 sachets DE) 1000 (20 bundles of 50 bags DE)	390 x 390 x 200 mm / 11,7 kg	3600
ITM020247	250 x 320	Ø TS 8 mm Ø TA 4 mm	1000 (20 rouleaux de 50 sachets DE) 1000 (20 bundles of 50 bags DE)	390 x 390 x 200 mm / 11,8 kg	4200
ITM020503	250 x 350	Ø TS 8 mm	1000 (20 rouleaux de 50 sachets DE) 1000 (20 bundles of 50 bags DE)	390 x 390 x 200 mm / 12,2 kg	4800
ITM020251	250 x 350	Ø TS 8 mm Ø TA 4 mm	1000 (20 rouleaux de 50 sachets DE) 1000 (20 bundles of 50 bags DE)	390 x 390 x 200 mm / 12,2 kg	4800
ITM020271	270 x 400	Ø TS 8 mm Ø TA 4 mm	1000 (20 rouleaux de 50 sachets DE) 1000 (20 bundles of 50 bags DE)	390 x 390 x 200 mm / 14,8 kg	6400
ITM020270	280 x 400	Ø TS 8 mm	1000 (20 rouleaux de 50 sachets DE) 1000 (20 bundles of 50 bags DE)	390 x 390 x 200 mm / 15,6 kg	6500
ITM020502	300 x 400	Ø TS 8 mm	1000 (20 rouleaux de 50 sachets DE) 1000 (20 bundles of 50 bags DE)	390 x 390 x 250 mm / 17 kg	7500
ITM020249	300 x 400	Ø TS 8 mm Ø TA 4 mm	1000 (20 rouleaux de 50 sachets DE) 1000 (20 bundles of 50 bags DE)	390 x 390 x 200 mm / 17 kg	7500
ITM020250	350 x 450	Ø TS 8 mm Ø TA 4 mm	500 (10 rouleaux de 50 sachets SE) 500 (10 bundles of 50 bags SE)	390 x 390 x 200 mm / 10,8 kg	11600
ITM020275	400 x 500	Ø TS 8 mm Ø TA 4 mm	500 (10 rouleaux de 50 sachets SE) 500 (10 bundles of 50 bags SE)	480 x 285 x 175 mm / 12,7 kg	15500

* Valeurs données seulement à titre indicatif.

* Values only given as an indication.

Propriétés / properties	
Conditions de stockage Storage conditions	Température: 16 à 24 °C / Temperature : 16 to 24 °C Taux d'humidité relative: 35 à 55 % / Relative humidity: 35 to 55 % Les marchandises doivent être stockées dans un environnement, propre, sec et exempt d'infestation et non exposées directement à de fortes chaleurs, lumières et odeurs. <i>The goods should be stored in a clean, dry environment and free from infestation, They should be protected against strong light, heat and odor.</i>
Garantie warranty conditions	12 mois à compter de la date du BL, sous réserve des conditions de stockage mentionnées ci-dessus. <i>12 months from the date of the BL, subject to the storage conditions mentioned above.</i>
Propriétés barrière Barrier properties	O2: Faibles / Low H2O: Moyenne / medium
Aptitude au contact alimentaire Food Contact	 Aptitude au contact alimentaire / Suitable for food contact
Recyclabilité / Recyclability <i>Evaluation réalisée sur l'outil TREE 4.0 de CITEO</i>	<div style="display: flex; justify-content: space-between;"> <div style="width: 45%;"> <p>Niveau de recyclabilité </p>  <p>Niveau A</p> <p>Filière de recyclage : Films et Souples PEBD</p> <p>Important : cette analyse n'a pas valeur de « certificat de recyclabilité ».</p> </div> <div style="width: 45%;"> <p>Taux de recyclabilité </p>  <p>100% 6g</p> <ul style="list-style-type: none"> ● 95 - 100 ● 80 - 95 ● 50 - 80 ● 0 - 50 </div> </div>

VALIDATION

Date : 18/04/2024